

**NOAA NESDIS  
CENTER for SATELLITE APPLICATIONS and  
RESEARCH**

**GOES-R Advanced Baseline Imager  
(ABI) Algorithm Theoretical Basis  
Document  
For  
Cloud Type and Cloud Phase**

*Michael Pavolonis, NOAA/NESDIS/STAR*

Version 2.0  
September 15, 2010

## TABLE OF CONTENTS

1	INTRODUCTION .....	10
1.1	Purpose of This Document .....	10
1.2	Who Should Use This Document .....	10
1.3	Inside Each Section .....	10
1.4	Related Documents .....	11
1.5	Revision History .....	11
2	OBSERVING SYSTEM OVERVIEW .....	12
2.1	Products Generated .....	12
2.1.1	Product Requirements .....	12
2.2	Instrument Characteristics .....	14
3	ALGORITHM DESCRIPTION .....	16
3.1	Algorithm Overview .....	16
3.2	Processing Outline .....	17
3.3	Algorithm Input .....	20
3.3.1	Primary Sensor Data .....	20
3.3.2	Derived Data .....	20
3.3.3	Ancillary Data .....	20
3.3.4	Radiative Transfer Models .....	21
3.4	Theoretical Description .....	21
3.4.1	Physics of the Problem .....	21
3.4.2	Mathematical Description .....	27
3.4.3	Algorithm Output .....	67
4	TEST DATA SETS AND OUTPUTS .....	70
4.1	Simulated/Proxy Input Data Sets .....	70
4.1.1	SEVIRI Data .....	70
4.2	Output from Simulated/Proxy Inputs Data Sets .....	73
4.2.1	Precisions and Accuracy Estimates .....	75
4.2.2	Error Budget .....	76
4.2.3	Validation Summary .....	80
5	PRACTICAL CONSIDERATIONS .....	81
5.1	Numerical Computation Considerations .....	81
5.2	Programming and Procedural Considerations .....	81
5.3	Quality Assessment and Diagnostics .....	82
5.4	Exception Handling .....	82
5.5	Algorithm Validation .....	82
6	ASSUMPTIONS AND LIMITATIONS .....	83
6.1	Performance .....	83
6.2	Assumed Sensor Performance .....	84
6.3	Pre-Planned Product Improvements .....	84
6.3.1	Incorporation of solar channels .....	84
6.3.2	Use of 10.4- $\mu$ m channel .....	84
6.3.3	Use of additional water vapor channels .....	84
7	REFERENCES .....	85

Wayne Mackenzie 6/11/13 10:41 PM

Deleted: 22

Wayne Mackenzie 6/11/13 10:41 PM

Deleted: 82

DRAFT

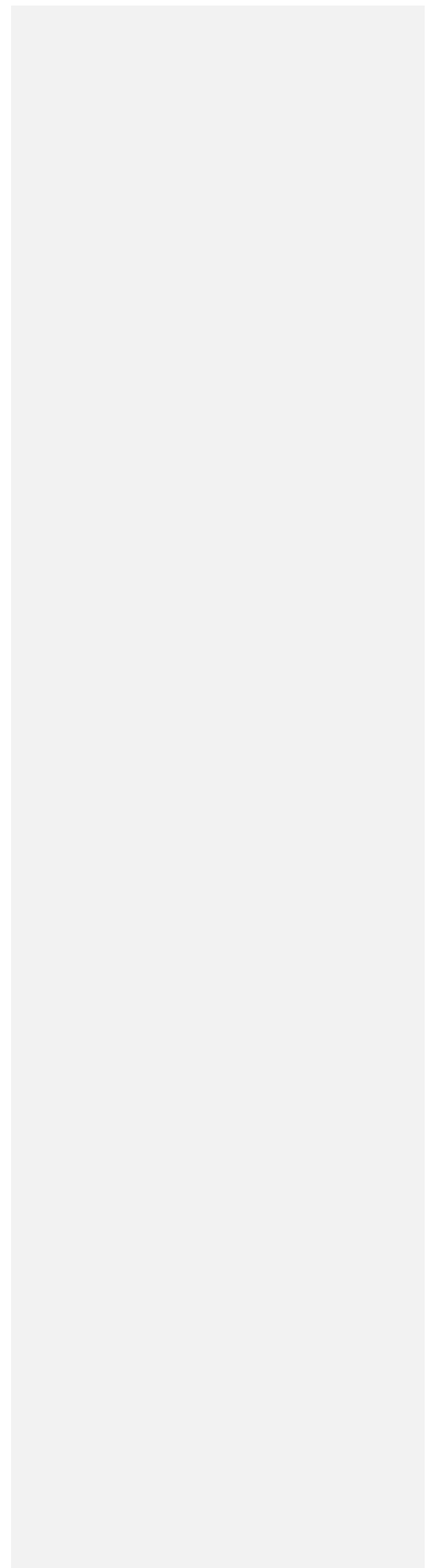

## LIST OF FIGURES

Figure 1: High Level Flowchart of the ACT illustrating the main processing sections. The tail of the pixel loop arrows indicates the start of a loop over all pixels in current scan line segment. The head of the arrow indicates the end of the loop. The first loop “yes” condition is that the pixel is earth geolocated and has valid spectral data (according to the L1b calibration quality flags). The “yes” condition ..... 18

Figure 2: The imaginary index of refraction for liquid water (red) and ice (blue) is shown as a function of wavelength. .... 23

Figure 3: The 8.5/11  $\mu\text{m}$  scaled extinction ratio ( $\beta(8.5/11\mu\text{m})$ ) is shown as a function of the effective particle radius for liquid water spheres (red) and ice plates (blue). These  $\beta$ -ratios were derived from the single scatter properties. .... 26

Figure 4: The 12/11  $\mu\text{m}$  scaled extinction ratio ( $\beta(12/11\mu\text{m})$ ) is shown as a function of the effective particle radius for liquid water spheres (red) and ice plates (blue). These  $\beta$ -ratios were derived from the single scatter properties. .... 27

Figure 5: The impact of the gradient filter is shown for the scene depicted by the false color RGB image (top). The  $\beta_{\text{tropo}}(8.5/11\mu\text{m})$  at each pixel is shown in the bottom, left panel and the bottom, right panel is the same as the bottom left, except the  $\beta_{\text{tropo}}(8.5/11\mu\text{m})$  for the LRC of each pixel is shown. Notice how anomalous values near cloud edges are absent from the LRC image. .... 35

Figure 6: Peirce-Hanssen-Kuipers skill score metrics are shown as a function of the  $\beta_{\text{sopaque}}(12/11\mu\text{m})$  threshold used to distinguish between clouds with a 11- $\mu\text{m}$  cloud optical depth of less than and greater than 2.0. The probability of false alarm (POF) is shown in blue, the probability of detection (POD) is shown in red, and the skill score is depicted by the black solid line. The  $\beta_{\text{sopaque}}(12/11\mu\text{m})$  threshold that maximizes the skill score is depicted by the dashed black line. This analysis is based on over 8000 SEVIRI/CALIOP match-ups. .... 39

Figure 7: Peirce-Hanssen-Kuipers skill score metrics are shown as a function of the absolute difference in the 7.4  $\mu\text{m}$  – 11  $\mu\text{m}$  opaque cloud temperature ( $T_{\text{opaque}}(\text{diff})$ ) ..... 40

Figure 8: The normalized distribution of  $\beta_{\text{mtropo}}(7.4/11\mu\text{m})$  is shown for single layer (black) and multilayered (red) definite ice clouds. CALIOP was used to identify single layer clouds with a cloud top temperature of 233 K or less and multilayered cloud systems where the cloud top temperature of the highest cloud layer is 233 K or less. The threshold used to distinguish between single and multilayered ice cloud systems is shown in blue. .... 44

Figure 9: The cumulative distribution function (CDF) of  $\beta_{\text{sopaque}}(8.5/11\mu\text{m})$  for 5 CALIOP-derived cloud top temperature bins is shown for 5 different bins of 7.4  $\mu\text{m}$  opaque cloud temperature ( $T_{\text{opaque}}(7.4\mu\text{m})$ ). In panel A,  $233\text{ K} < T_{\text{opaque}}(7.4\mu\text{m}) < 243\text{ K}$ . In panel B,  $243\text{ K} < T_{\text{opaque}}(7.4\mu\text{m}) < 253\text{ K}$ . In panel C,  $253\text{ K} < T_{\text{opaque}}(7.4\mu\text{m}) < 263\text{ K}$ . In panel D,  $T_{\text{opaque}}(7.4\mu\text{m}) > 263\text{ K}$ . Finally in panel E,  $T_{\text{opaque}}(7.4\mu\text{m})$  is undefined because the cloud is well below the peak of the 7.4  $\mu\text{m}$  weighting function or the cloud is too optically thin to be differentiated from the 7.4  $\mu\text{m}$  clear sky signal. .... 50

Figure 10: The cumulative distribution function (CDF) of $\beta_{\text{stropo}}(8.5/11\mu\text{m})$ for 5 CALIOP-derived cloud top temperature bins is shown for 3 different bins of $7.4\mu\text{m}$ opaque cloud temperature ( $T_{\text{opaque}}(7.4\mu\text{m})$ ). In panel A, $233\text{ K} < T_{\text{opaque}}(7.4\mu\text{m}) < \dots$	56
Figure 11: The cumulative distribution function (CDF) of $\beta_{\text{sopaque}}(8.5/11\mu\text{m})$ for 5 CALIOP-derived cloud top temperature bins is shown for 4 different bins of $11\mu\text{m}$ opaque cloud temperature ( $T_{\text{opaque}}(11\mu\text{m})$ ). In panel A, $233\text{ K} < T_{\text{opaque}}(11\mu\text{m}) < 243\text{ K}$ . In panel B, $243\text{ K} < T_{\text{opaque}}(11\mu\text{m}) < 253\text{ K}$ . In panel C, $253\text{ K} < T_{\text{opaque}}(11\mu\text{m}) < 263\text{ K}$ . In panel D, $263\text{ K} < T_{\text{opaque}}(11\mu\text{m}) < 273\text{ K}$ .	61
Figure 12: A flow chart of the decision tree used to determine cloud type using the results of several logical tests described in Section 3.4.2.6.1 through Section 3.4.2.6.16 is shown.	64
Figure 13: The impacts of the median filter are shown. Unfiltered cloud type output is shown on the top and filtered cloud type output on the bottom. Note how the median filter removes artifacts near the edge of the different cloud categories indicated by different colors.	66
Figure 14: SEVIRI RGB image from 12 UTC on November 24, 2006.	72
Figure 15: Illustration of the CALIPSO data used in this study. Top image shows a 2d backscatter profile. Bottom image shows the detected cloud layers overlaid onto the backscatter image. Cloud layers are color magenta.	73
Figure 16: Example results (using SEVIRI) from the ABI cloud typing and cloud phase algorithms for November 25, 2005. The top, left panel is a RGB false color image and the top, right and bottom, left panels show the cloud type and cloud phase results, respectively.	74
Figure 17: A more detailed look at the cloud type results shown in Figure 16 for a small region near the Ivory Coast of Africa.	75
Figure 18: The total cloud phase error as a function of the assumed error in classifying potentially mixed phase clouds is shown when the minimum cloud optical depth qualifier is <i>ignored</i> (top) and when it <i>is</i> applied (bottom) with the solid black line. The dashed red line is the allowed error from the F&PS. The dashed blue line is the actual accuracy achieved without including potentially mixed phase clouds in the validation analysis.	78
Figure 19: Same as Figure 18, except for cloud type.	80

## LIST OF TABLES

Table 1: GOES-R cloud top phase product requirements. The Geographic Coverage definitions are: M=Mesoscale, C=CONUS, and FD=Full Disk.....	13
Table 2: GOES-R cloud type product requirements. The Geographic Coverage definitions are: M=Mesoscale, C=CONUS, and FD=Full Disk.....	14
Table 3: Channel numbers and wavelengths for the ABI.....	15
Table 4: Inputs used in calculation of Local Radiative Center (LRC). The gradient filter function used in the calculation is described in the AIADD document. ....	35
Table 5: The thresholds used by the Low Surface Emissivity (LSE) Test as a function of sensor.....	37
Table 6: The thresholds used by the $\beta(12/11\mu\text{m})$ Opaque Cloud (BOC) Test as a function of sensor.....	39
Table 7: The thresholds used by the Opaque Cloud Temperature Difference (OCTD) Test as a function of sensor.....	41
Table 8: The thresholds used by the Water Vapor Multilayered Detection (WVMD) Test as a function of sensor.....	44
Table 9: The thresholds used by the Infrared Window Multilayered Detection (IWMD) Test as a function of sensor.....	46
Table 10: “BOWVIC_Thresh1” threshold values used in the $\beta_{\text{sopaque}}(8.5/11\mu\text{m})$ and Water Vapor Ice Cloud (BOWVIC) Test as a function of sensor and $7.4\mu\text{m}$ opaque cloud temperature ( $T_{\text{opaque}}(7.4\mu\text{m})$ ).....	51
Table 11: “BOWVIC_Thresh2” threshold values used in the $\beta_{\text{sopaque}}(8.5/11\mu\text{m})$ and Water Vapor Ice Cloud (BOWVIC) Test as a function of sensor and $7.4\mu\text{m}$ opaque cloud temperature ( $T_{\text{opaque}}(7.4\mu\text{m})$ ).....	51
Table 12: “BOWVIC_Thresh3” threshold values used in the $\beta_{\text{sopaque}}(8.5/11\mu\text{m})$ and Water Vapor Ice Cloud (BOWVIC) Test as a function of sensor and $7.4\mu\text{m}$ opaque cloud temperature ( $T_{\text{opaque}}(7.4\mu\text{m})$ ).....	51
Table 13: “BOWVIC_Thresh4” threshold values used in the $\beta_{\text{sopaque}}(8.5/11\mu\text{m})$ and Water Vapor Ice Cloud (BOWVIC) Test as a function of sensor and $7.4\mu\text{m}$ opaque cloud temperature ( $T_{\text{opaque}}(7.4\mu\text{m})$ ).....	52
Table 14: “BOWVIC_Thresh5” threshold values used in the $\beta_{\text{sopaque}}(8.5/11\mu\text{m})$ and Water Vapor Ice Cloud (BOWVIC) Test as a function of sensor and $7.4\mu\text{m}$ opaque cloud temperature ( $T_{\text{opaque}}(7.4\mu\text{m})$ ).....	52
Table 15: “BOWVIC_Thresh6” threshold values used in the $\beta_{\text{sopaque}}(8.5/11\mu\text{m})$ and Water Vapor Ice Cloud (BOWVIC) Test as a function of sensor and $7.4\mu\text{m}$ opaque cloud temperature ( $T_{\text{opaque}}(7.4\mu\text{m})$ ).....	52
Table 16: The third and fourth thresholds used by the $\beta_{\text{sopaque}}(8.5/11\mu\text{m})$ and Water Vapor Ice Cloud LRC-only (BOWVIC-LRC) Test as a function of sensor.....	53
Table 17: The thresholds used by the $\beta_{\text{sopaque}}(8.5/11\mu\text{m})$ Opaque Ice Cloud (BOIC) Test as a function of sensor.....	54

Table 18: “BTWVIC_Thresh1” threshold values used in the $\beta_{\text{stropo}}(8.5/11\mu\text{m})$ and Water Vapor Ice Cloud (BTWVIC) Test as a function of sensor and 7.4 $\mu\text{m}$ opaque cloud temperature ( $T_{\text{opaque}}(7.4\mu\text{m})$ ).	57
Table 19: “BTWVIC_Thresh2” threshold values used in the $\beta_{\text{stropo}}(8.5/11\mu\text{m})$ and Water Vapor Ice Cloud (BTWVIC) Test as a function of sensor and 7.4 $\mu\text{m}$ opaque cloud temperature ( $T_{\text{opaque}}(7.4\mu\text{m})$ ).	57
Table 20: The “BTWVIC_Thresh3” and ” BTWVIC_Thresh4” thresholds used by the $\beta_{\text{stropo}}(8.5/11\mu\text{m})$ Water Vapor Ice Cloud (BTWVIC) Test as a function of sensor.	58
Table 21: The thresholds used by the Sub-classify Ice Cloud (SCIC) Test as a function of sensor.	59
Table 22: “MP_Thresh1” threshold values used in the Mixed Phase (MP) Test as a function of sensor and 11 $\mu\text{m}$ opaque cloud temperature ( $T_{\text{opaque}}(11\mu\text{m})$ ).	62
Table 23: “MP_Thresh2” threshold values used in the Mixed Phase (MP) Test as a function of sensor and 11 $\mu\text{m}$ opaque cloud temperature ( $T_{\text{opaque}}(11\mu\text{m})$ ).	62
Table 24: “MP_Thresh3” threshold values used in the Mixed Phase (MP) Test as a function of sensor and 11 $\mu\text{m}$ opaque cloud temperature ( $T_{\text{opaque}}(11\mu\text{m})$ ).	62
Table 25: “MP_Thresh4” threshold values used in the Mixed Phase (MP) Test as a function of sensor and 11 $\mu\text{m}$ opaque cloud temperature ( $T_{\text{opaque}}(11\mu\text{m})$ ).	63
Table 26: Correspondence between cloud phase and cloud type categories.	66
Table 27: A description of the cloud type output.	67
Table 28: A description of the cloud phase output.	67
Table 29: A complete description of the cloud type/phase quality flag output is shown.	69
Table 30: A complete description of the cloud type/phase Product Quality Information (PQI) output is shown.	70
Table 31: A complete description of the cloud type/phase metadata output is shown.	70
Table 32: The SEVIRI bands used to test the ABI cloud phase and type algorithm is shown relative to the corresponding ABI bands.	71
Table 33: ABI cloud phase validation statistics <i>without</i> invoking minimum cloud optical depth qualifier are shown. The liquid water and supercooled water categories are combined since differences between the two categories are solely a function of the measured 11- $\mu\text{m}$ brightness temperature. Potentially mixed phase clouds ( $268\text{ K} < T_{\text{cld}} < 238\text{ K}$ ) are counted in the total statistics.	76
Table 34: Same as Table 32, except the minimum cloud optical depth qualifier <i>is</i> invoked.	77
Table 35: ABI cloud type validation statistics <i>without</i> invoking minimum cloud optical depth qualifier are shown. The liquid water and supercooled water categories are combined since differences between the two categories are solely a function of the measured 11- $\mu\text{m}$ brightness temperature. Potentially mixed phase clouds ( $268\text{ K} < T_{\text{cld}} < 238\text{ K}$ ) are counted in the total statistics.	79
Table 36: Same as Table 34, except the minimum cloud optical depth qualifier <i>is</i> invoked.	79

## LIST OF ACRONYMS

ABI – Advanced Baseline Imager  
AC – Above Cloud  
ACT – ABI Cloud Type  
AIADD – Algorithm Interface and Ancillary Data Description  
ARM – Atmospheric Radiation Measurement  
ATBD – Algorithm Theoretical Basis Document  
AVHRR – Advanced Very High Resolution Radiometer  
AWG – Algorithm Working Group  
CALIOP – Cloud-Aerosol Lidar with Orthogonal Polarization  
CALIPSO – Cloud-Aerosol Lidar and Infrared Pathfinder Satellite Observation  
CDF – Cumulative Distribution Function  
CONUS – Continental United States  
ECMWF – European Centre for Medium-Range Weather Forecasts  
EOS – Earth Observing System  
ESA – European Space Agency  
F&PS – Functional & Performance Specification  
GOES – Geostationary Operational Environmental Satellite  
LRC – Local Radiative Center  
MODIS – Moderate Resolution Imaging Spectroradiometer  
NASA – National Aeronautics and Space Agency  
NESDIS – National Environmental Satellite, Data, and Information Service  
NOAA – National Oceanic and Atmospheric Administration  
NWP – Numerical Weather Prediction  
POES – Polar Operational Environmental Satellite  
SEVIRI – Spinning Enhanced Visible and Infrared Imager  
SSEC – Space Science and Engineering Center  
STAR – Center for Satellite Applications and Research  
TOA – Top of Atmosphere  
TRR – Test Readiness Review  
UTC – Coordinated Universal Time



## ABSTRACT

This document provides a high level description of the physical basis for the determination of cloud type and cloud phase information, of each cloudy pixel within images taken by the Advanced Baseline Imager (ABI) flown on the GOES-R series of NOAA geostationary meteorological satellites. The cloud phase is determined from the cloud type information within the same algorithm module. Thus, the cloud type and cloud phase are described in the same ATBD. The cloud phase and type categories are based on heritage NOAA cloud phase and type products.

The ABI cloud type/phase algorithm utilizes a series of spectral and spatial tests to determine the cloud type (liquid water, supercooled water, mixed phase, optically thin ice, optically thick ice, and multilayered ice). The algorithm utilizes ABI channels 10 (7.4  $\mu\text{m}$ ), 11 (8.5  $\mu\text{m}$ ), 14 (11  $\mu\text{m}$ ), and 15 (12  $\mu\text{m}$ ), which are all infrared channels. In lieu of brightness temperature differences, effective absorption optical depth ratios are used in the spectral tests. Effective absorption optical depth ratios, allow for improved sensitivity to cloud microphysics, especially for optically thin clouds. The validation analysis indicates that the algorithm with comfortably meet the accuracy requirements.

# 1 INTRODUCTION

## 1.1 Purpose of This Document

The cloud type algorithm theoretical basis document (ATBD) provides a high level description of the physical basis for the determination of cloud type and cloud phase information, of each cloudy pixel within images taken by the Advanced Baseline Imager (ABI) flown on the GOES-R series of NOAA geostationary meteorological satellites. The cloud phase is determined from the cloud type information within the same algorithm module. Thus, the cloud type and cloud phase are described in the same ATBD. Output from the cloud type and cloud phase algorithms are made available to all subsequent algorithms that require knowledge of the cloud type or phase of cloudy pixels. The cloud type and phase algorithm only operates on cloudy pixels and, hence, depends on the ABI cloud mask.

## 1.2 Who Should Use This Document

The intended users of this document are those interested in understanding the physical basis of the algorithms and how to use the output of this algorithm to optimize the cloud phase and type for a particular application. This document also provides information useful to anyone maintaining or modifying the original algorithm.

## 1.3 Inside Each Section

This document is broken down into the following main sections.

- **System Overview:** Provides relevant details of the ABI and provides a brief description of the products generated by the algorithm.
- **Algorithm Description:** Provides all the detailed description of the algorithm including its physical basis, its input and its output.
- **Test Data Sets and Outputs:** Provides a detailed description of the data sets used to develop and test the GOES-R ABI algorithm and describes the algorithm output.
- **Practical Considerations:** Provides a description of algorithm programming and quality control considerations.
- **Assumptions and Limitations:** Provides an overview of the current limitations of the approach and gives the plan for overcoming these limitations with further algorithm development.

## 1.4 Related Documents

- GOES-R Functional & Performance Specification Document (F&PS)
- GOES-R ABI Cloud Product Validation Plan Document
- Algorithm Interface and Ancillary Data Description (AIADD) Document

## 1.5 Revision History

- 9/30/2008 - Version 0.1 of this document was created by Michael J Pavolonis (NOAA/NESDIS/STAR). Version 0.1 represents the first draft of this document.
- 6/30/2009 – Version 1.0 of this document was created by Michael J Pavolonis (NOAA/NESDIS/STAR). In this revision, Version 1.0 was revised to meet 80% delivery standards.
- 6/30/2010 – Version 2.0 of this document was created by Michael J Pavolonis (NOAA/NESDIS/STAR). In this revision, Version 2.0 was revised to meet 100% delivery standards.
- 9/15/2010 – Version 2.0 of this document was revised by Michael J Pavolonis (NOAA/NESDIS/STAR). In this revision, Version 2.0 was revised further to meet 100% delivery standards.

## 2 OBSERVING SYSTEM OVERVIEW

This section will describe the products generated by the ABI Cloud Phase/Type Algorithm and the requirements it places on the sensor.

### 2.1 Products Generated

The cloud type product consists of 6 cloud classifications. In addition, the cloud phase product consists of 4 cloud classifications. The cloud type categories are: warm liquid water cloud, supercooled liquid water, mixed phase, opaque ice, cirrus (e.g. semi-transparent ice clouds), and multilayered cloud (with semi-transparent upper-layer). The cloud phase categories are: warm liquid water phase, supercooled liquid water phase, mixed phase, and ice phase. The cloud phase is directly derived from the cloud type categories. The cloud type product contains information on multilayered clouds and cirrus that is useful to higher-level algorithms such as the cloud top height retrieval. The cloud phase and type categories are consistent with heritage products such as those from Moderate Resolution Imaging Spectroradiometer (MODIS) and Advanced Very High Resolution Radiometer (AVHRR).

Downstream cloud algorithms, such as the cloud height, the cloud optical properties algorithms, the fog detection/fog depth algorithm, and the cloud-icing algorithm, require the cloud type and phase products. The cloud type and phase information can also be used in advanced ABI applications such as severe weather prediction and tropical cyclone intensity estimation.

#### 2.1.1 Product Requirements

The F&PS spatial, temporal, and accuracy requirements for the GOES-R cloud phase and cloud type are shown below in Table 1 and Table 2, respectively.

Name	User & Priority	Geographic Coverage	Vertical Res.	Horiz. Res.	Mapping Accuracy	Misamt. Rang	Misamt. Accuracy	Refresh Rate/Coverage Time Option (Mode 3)	Refresh Rate Option (Mode 4)	Data Latency	Long-Term	Product Measurement Precision
Cloud Top Phase	GOES-R	C	Cloud Top	2 km	1 km	Liquid/solid/supercooled/mixed	80% Correct Classification	5 min	5 min	266 sec	TBD	1.5 categories <i>(requested change to NA)</i>
Cloud Top Phase	GOES-R	FD	Cloud Top	2 km	1 km	Liquid/solid/supercooled/mixed	80% Correct Classification	15 min	15 min	806 sec	TBD	1.5 categories <i>(requested change to NA)</i>
Cloud Top Phase	GOES-R	M	Cloud Top	2 km	1 km	Liquid/solid/supercooled/mixed	80% Correct Classification	5 min	NA	266 sec	TBD	1.5 categories <i>(requested change to NA)</i>

Name	User & Priority	Geographic Coverage	Temporal Coverage Qualifiers	Product Extend Qualifiers	Cloud Cover Conditions Qualifiers	Product Statistics Qualifier
Cloud Top Phase	GOES-R	C	Day and night	Quantitative out to at least 65 degrees LZA and qualitative beyond	In presence of clouds with optical depth >1. Clear conditions down to cloud top associated with threshold accuracy	Over specified geographic area
Cloud Top Phase	GOES-R	FD	Day and night	Quantitative out to at least 65 degrees LZA and qualitative beyond	In presence of clouds with optical depth >1. Clear conditions down to cloud top associated with threshold accuracy	Over specified geographic area
Cloud Top Phase	GOES-R	M	Day and night	Quantitative out to at least 65 degrees LZA and qualitative beyond	In presence of clouds with optical depth >1. Clear conditions down to cloud top associated with threshold accuracy	Over specified geographic area

**Table 1: GOES-R cloud top phase product requirements. The Geographic Coverage definitions are: M=Mesoscale, C=CONUS, and FD=Full Disk.**

Name	User & Priority	Geographic Coverage	Vertical Res.	Horiz. Res.	Mapping Accuracy	Misamt. Rang	Misamt. Accuracy	Refresh Rate/Coverage Time Option (Mode 3)	Refresh Rate Option (Mode 4)	Data Latency	Long-Term	Product Measurement Precision
Cloud Type	GOES-R	C	NA	10 km	5 km	7 Types	60% correct classification	15 min	5 min	536 sec	TBD	2.5 categories <i>(requested change to NA)</i>
Cloud Type	GOES-R	FD	NA	2 km	1 km	7 Types	60% correct classification	15 min	5 min	159 sec	TBD	2.5 categories <i>(requested change to NA)</i>
Cloud Type	GOES-R	M	NA	2 km	1 km	7 Types	60% correct classification	15 min	NA	266 sec	TBD	2.5 categories <i>(requested change to NA)</i>

Name	User & Priority	Geographic Coverage	Temporal Coverage Qualifiers	Product Extend Qualifiers	Cloud Cover Conditions Qualifiers	Product Statistics Qualifier
Cloud Type	GOES-R	C	Day and night	Quantitative out to at least 65 degrees LZA and qualitative beyond	In presence of clouds with optical depth >1. Clear conditions down to cloud top associated with threshold accuracy	Over specified geographic area
Cloud Type	GOES-R	C	Day and night	Quantitative out to at least 65 degrees LZA and qualitative beyond	In presence of clouds with optical depth >1. Clear conditions down to cloud top associated with threshold accuracy	Over specified geographic area
Cloud Type	GOES-R	C	Day and night	Quantitative out to at least 65 degrees LZA and qualitative beyond	In presence of clouds with optical depth >1. Clear conditions down to cloud top associated with threshold accuracy	Over specified geographic area

**Table 2: GOES-R cloud type product requirements. The Geographic Coverage definitions are: M=Mesoscale, C=CONUS, and FD=Full Disk.**

## 2.2 Instrument Characteristics

The cloud type and phase algorithm will be applied to each cloudy ABI pixel. [Table 3](#) summarizes the channels used by the ABI Cloud Type (ACT). Recall that the cloud phase product is produced from the cloud type product.

Wayne Mackenzie 6/11/13 10:41 PM

Deleted: Table 3

<i>Channel Number</i>	<i>Wavelength (<math>\mu\text{m}</math>)</i>	<i>Used in ACT</i>
1	0.47	
2	0.64	
3	0.86	
4	1.38	
5	1.61	
6	2.26	
7	3.9	
8	6.15	
9	7.0	
10	7.4	✓
11	8.5	✓
12	9.7	
13	10.35	
14	11.2	✓
15	12.3	✓
16	13.3	

**Table 3: Channel numbers and wavelengths for the ABI.**

The ACT relies on infrared radiances to avoid day/night/terminator discontinuities. The algorithm relies on spectral and spatial tests, as well as the ABI cloud mask. The performance of the cloud type algorithm is therefore sensitive to any imagery artifacts or instrument noise as well as the correct identification of cloudy pixels. Calibrated observations are also critical because the cloud type compares the observed values to those from a forward radiative transfer model. The channel specifications are given in the F&PS section 3.4.2.1.4.0. We are assuming the performance outlined in the F&PS during our development efforts.

### 3 ALGORITHM DESCRIPTION

Below is a complete description of the final algorithm.

#### 3.1 Algorithm Overview

The cloud type and phase products serve a critical role in the cloud property component of the GOES-R ABI processing system. Cloud top phase is a fundamental cloud property that is required by downstream cloud algorithms such as the cloud top height algorithm, the cloud optical property algorithm, the fog detection/fog depth algorithm, and the cloud-icing algorithm.

The GOES-R cloud type categories are based on the heritage GOES and POES (Advanced Very High Resolution Radiometer (AVHRR)) cloud type categories adopted by NESDIS/STAR. These categories were chosen on the basis that they could be derived from the measured radiances at all times during the day, unlike morphological cloud categories (e.g. stratus, stratocumulus, altocumulus, etc...), which can only be derived reliably when daylight is present. The chosen categories are also useful to downstream algorithms like cloud top height and cloud optical properties. The cloud type categories for cloudy pixels are:

- **Warm liquid water** (liquid water cloud with an opaque cloud temperature greater than 273 K)
- **Supercooled liquid water** (liquid water topped cloud with an opaque cloud temperature less than 273 K)
- **Mixed phase clouds** (high probability of containing both liquid water and ice near cloud top)
- **Optically thin ice clouds** (ice clouds which have an infrared optical depth of about 2.0 or less)
- **Optically thick ice clouds** (high emissivity ice topped clouds, infrared optical depths greater than 2.0)
- **Multilayered clouds** (optically thin ice cloud overlapping a lower optically thick cloud layer)

The cloud phase categories for cloudy pixels are:

- **Warm liquid water** (liquid water cloud with an opaque cloud temperature greater than 273 K)
- **Supercooled liquid water** (liquid water topped cloud with an opaque cloud temperature less than 273 K)
- **Mixed phase clouds** (high probability of containing both liquid water and ice near cloud top)
- **Ice phase clouds** (all ice topped clouds)



The cloud phase product is derived from the cloud type product. One can simply think of the cloud phase product as a slightly less descriptive version of the cloud type output. As [Table 3](#) shows, the ABI Cloud Type (ACT) algorithm does not use solar-contaminated channels. A satellite-measured reflectance is a function of cloud microphysics, surface type, viewing and illumination geometry, and other factors. Due to the complex nature of scattering in the visible and near-infrared, and our inability to quickly simulate satellite reflectance values, we have chosen to avoid using sunlight contaminated channels at this time. One advantage of using infrared-only approach is that the algorithm performance is spectrally day/night independent (e.g. the same procedure is applied at all times).

The ACT derives the following ABI cloud products listed in the F&PS.

- Cloud type (6 cloud categories)
- Cloud phase (4 cloud categories)

Both of these products are derived at the pixel level for all cloudy pixels.

In addition, the ACT derives the following products that are not included in the F&PS.

- Quality Flags (defined in Section 3.4.3)
- Product Quality Information (defined in Section 3.4.3)
- Metadata (defined in Section 3.4.3)

### 3.2 Processing Outline

As described earlier, the cloud type algorithm requires *a priori* knowledge of which pixels are cloudy. Thus, prior to calling the cloud type algorithm, the ABI cloud mask algorithm must be applied. Given this requirement, the algorithm processing precedence is as follows: ABI cloud mask --> cloud type/phase routine. The ACT requires multiple scan lines of ABI data due to the spatial analysis that is utilized in the algorithm. Complete scan line segments should consist of at least the minimum number of scan lines required by the Gradient Filter, which is described in detail in the AIADD. While overlap between adjacent scan line segments is beneficial, scan line overlap was not used in the development and validation of this algorithm. The processing outline of the ACT is summarized in [Figure 1](#).

Wayne Mackenzie 6/11/13 10:41 PM

Deleted: Table 3

Wayne Mackenzie 6/11/13 10:41 PM

Deleted: Figure 1

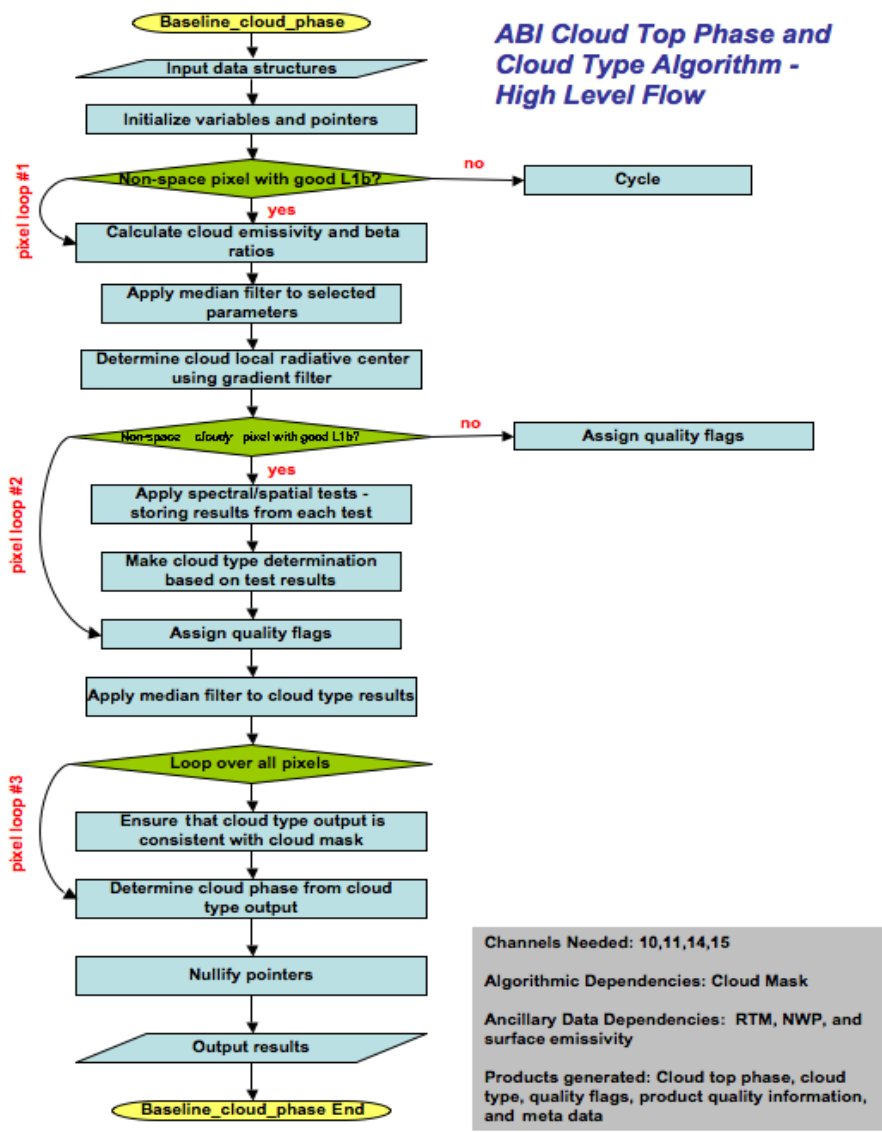
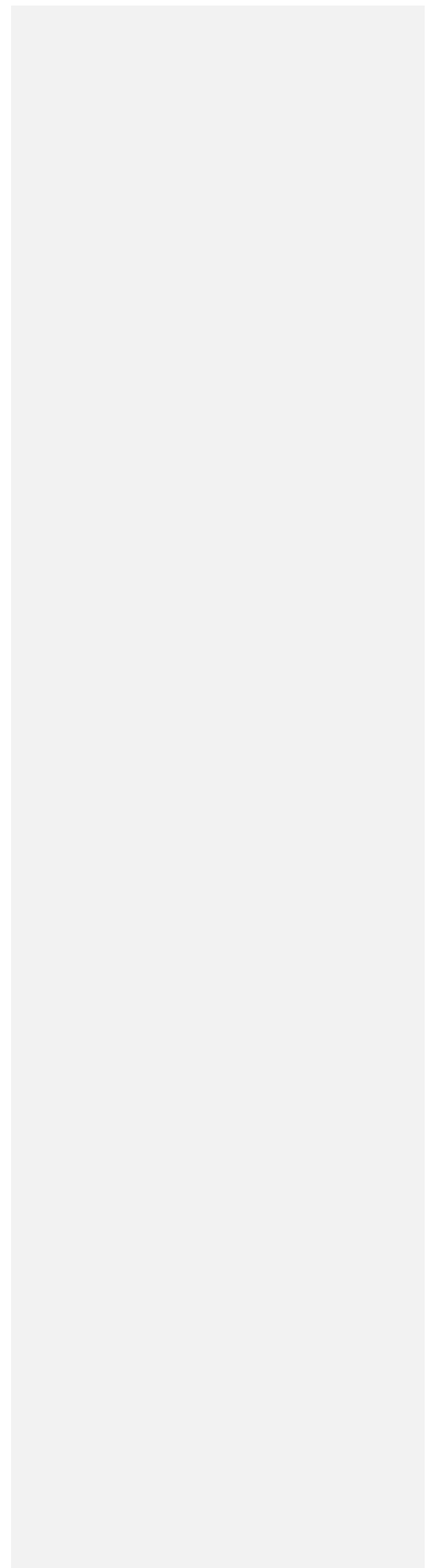

Figure 1: High Level Flowchart of the ACT illustrating the main processing sections. The tail of the pixel loop arrows indicates the start of a loop over all pixels in current scan line segment. The head of the arrow indicates the end of the loop. The first loop “yes” condition is that the pixel is earth geolocated and has valid spectral data (according to the L1b calibration quality flags). The “yes” condition for the second loop is that the pixel is earth geolocated, has valid spectral data, and is cloudy. The third loop is over all pixels.

DRAFT



### 3.3 Algorithm Input

This section describes the input needed to process the ACT. While the ACT operates on a pixel-by-pixel basis, surrounding pixels are needed for spatial analysis. Therefore, the ACT must have access to a group of pixels. In its current configuration, we run the ACT on segments comprised of 200 scan-lines. The minimum scan line segment size required to implement the ACT is driven by the minimum number of scan lines required to fully utilize the gradient filter routine (see AIADD Document for more details). The following sections describe the actual input needed to run the ACT.

#### 3.3.1 Primary Sensor Data

The list below contains the primary sensor data currently used by the ACT. By primary sensor data, we mean information that is derived solely from the ABI observations and geolocation information.

- Calibrated radiances for ABI channels 10 (7.4  $\mu\text{m}$ ), 11 (8.5  $\mu\text{m}$ ), 14 (11  $\mu\text{m}$ ), and 15 (12  $\mu\text{m}$ )
- Calibrated brightness temperature for ABI channel 14 (11  $\mu\text{m}$ )
- Sensor viewing zenith angle
- L1b quality information from calibration for ABI channels 10, 11, 14, and 15
- Space mask (is the pixel geolocated on the surface of the Earth?)
- ABI cloud mask output (product developed by cloud team)

#### 3.3.2 Derived Data

The following upstream ABI derived products are needed by the ACT.

- ABI cloud mask output – the ACT requires the ABI cloud mask described in the cloud mask ATBD. The cloud mask is used to identify cloudy pixels. The cloud phase is not determined for clear pixels.

#### 3.3.3 Ancillary Data

The following data lists and briefly describes the ancillary data required to run the ACT. By ancillary data, we mean data that requires information not included in the ABI observations or geolocation data.

- **Surface emissivity of ABI channel 11 (8.5  $\mu\text{m}$ )**  
A global database of monthly mean infrared land surface emissivity is required for ABI channel 11. The ACT utilizes surface emissivity derived using the Moderate Resolution Imaging Spectroradiometer (MODIS). Emissivity is

available globally at ten generic wavelengths (3.6, 4.3, 5.0, 5.8, 7.6, 8.3, 9.3, 10.8, 12.1, and 14.3 microns) with 0.05 degree spatial resolution (Seemann et al. 2008). The ten wavelengths serve as anchor points in the linear interpolation to any wavelength between 3.6 and 14.3 microns. The monthly emissivities have been integrated over the ABI spectral response functions to match the ABI channels. This data set and the procedure for spectrally and spatially mapping it to the ABI are described in detail in Seemann et al. (2008) and the AIADD Document.

- **Profiles of pressure and temperature**

The calculation of cloud emissivity requires profiles of pressure and temperature from a global Numerical Weather Prediction (NWP) model. In addition, knowledge of the location of the surface and tropopause levels is required. While six-hour forecasts were used in the development of the ACT, and, as such, are recommended, any forecast in the 0 to 24 hour range is acceptable. Details concerning the NWP data can be found in the AIADD Document.

### 3.3.4 Radiative Transfer Models

The following lists and briefly describes the data that must be calculated by a radiative transfer model and derived prior to running the ACT. See the AIADD Document for a more detailed description.

- **Black cloud radiance profiles for channels 10, 11, 14, and 15**

The ACT requires the radiance emitted upward by a black body surface and transmitted through a non-cloudy atmosphere, with gaseous absorption, to the top of the atmosphere as a function of the atmospheric level of the black surface. The black cloud radiance is computed as a function of NWP grid cells and viewing angle (it is not computed at the pixel resolution), as described in detail in the AIADD Document.

- **Top-of-atmosphere clear-sky radiance estimates for channels 10, 11, 14, and 15**

The ACT requires knowledge of the top-of-atmosphere radiance ABI would sense under clear-sky conditions at each pixel.

## 3.4 Theoretical Description

The methodology described in this section is based on the physical concepts described in Pavolonis (2010a and 2010b).

### 3.4.1 Physics of the Problem

The cloud type algorithm utilizes ABI Channels 10, 11, 14, and 15. These channels have an approximate central wavelength of 7.4, 8.5, 11, and 12  $\mu\text{m}$ , respectively. These central wavelengths will be referred to rather than the ABI channel numbers throughout the “Theoretical Description.”

The spectral sensitivity to cloud composition is perhaps best understood by examining the imaginary index of refraction for liquid and ice,  $m_i$ , as a function of wavelength. The imaginary index of refraction is often directly proportional to absorption/emission strength for a given particle composition, in that larger values are indicative of stronger absorption of radiation at a particular wavelength. However, absorption due to photon tunneling, which is proportional to the real index of refraction, can also contribute to the observed spectral absorption under certain circumstances (Mitchell, 2000). For simplicity, only absorption by the geometrical cross section, which is captured by the imaginary index of refraction, is discussed here. Figure 2 shows  $m_i$  for liquid water (Downing and Williams, 1975) and ice (Warren and Brandt, 2008). The  $m_i$  can be interpreted as follows. In Figure 2, one sees that around 8.5 - 10  $\mu\text{m}$  liquid water and ice absorb approximately equally, while near 11 - 13.5  $\mu\text{m}$  ice absorbs more strongly than water. Thus, all else being equal, the difference in measured radiation (or brightness temperature) between an 8.5  $\mu\text{m}$  channel and an 11  $\mu\text{m}$  channel (or 12  $\mu\text{m}$  or 13.3  $\mu\text{m}$  channel) will be larger for an ice cloud compared to a liquid water cloud. The previous statement is only accurate if the liquid water and ice cloud have the same particle concentrations at the same vertical levels in the same atmosphere, and have the same particle size and shape distribution. That is what is meant by “all else being equal.” While Figure 2 is insightful, it can also be deceiving if not interpreted correctly. For example, it is possible that a liquid water cloud in a certain vertical layer with a certain particle distribution will look identical (in measurement space) to an ice cloud at the same vertical layer (in the same atmosphere), but with a different particle distribution. As another example, a scene with a liquid water cloud in one type of atmosphere (e.g. maritime tropical) may exhibit the same measured spectral radiance as a scene with an ice cloud in another type of atmosphere (e.g. continental mid-latitude).

In order to maximize the sensitivity to cloud phase/type, the information contained in Figure 2 must be extracted from the measured radiances as best as possible. One way of doing this is to account for the background conditions (e.g. surface temperature, surface emissivity, atmospheric temperature, and atmospheric water vapor) of a given scene in an effort to isolate the cloud microphysical signal. This is difficult to accomplish with traditional brightness temperatures and brightness temperature differences. In the following section, we derive a data space that accounts for the background conditions.

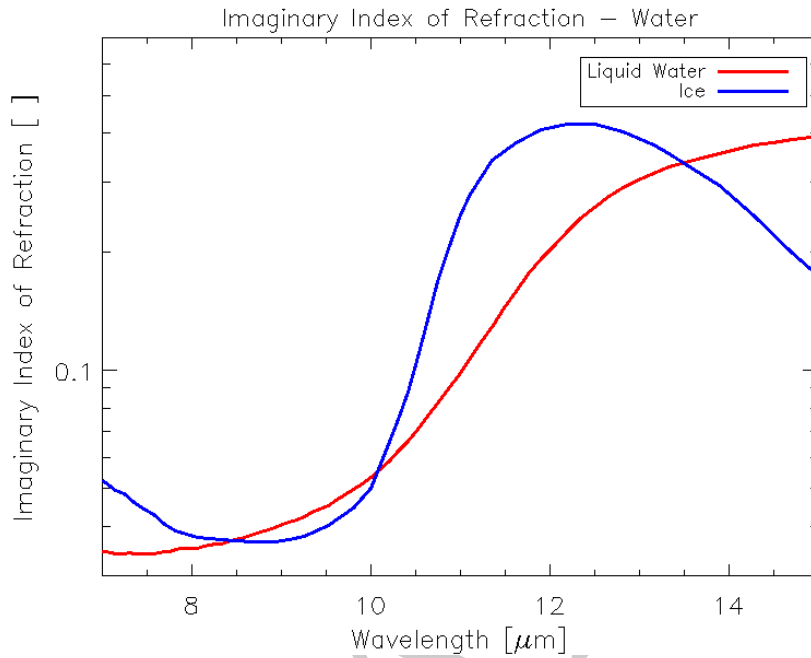

**Figure 2: The imaginary index of refraction for liquid water (red) and ice (blue) is shown as a function of wavelength.**

### 3.4.1.1 Infrared Radiative Transfer

Assuming a satellite viewing perspective (e.g. upwelling radiation), a fully cloudy field of view, a non-scattering atmosphere (no molecular scattering), and a negligible contribution from downwelling cloud emission or molecular emission that is reflected by the surface and transmitted to the top of troposphere (Zhang and Menzel (2002) showed that this term is very small at infrared wavelengths), the cloudy radiative transfer equation for a given infrared channel or wavelength can be written as in Equation 1 (e.g. Heidinger and Pavolonis, 2009; Pavolonis, 2010a).

$$R_{obs}(\lambda) = \varepsilon(\lambda)R_{ac}(\lambda) + t_{ac}(\lambda)\varepsilon(\lambda)B(\lambda, T_{eff}) + R_{clr}(\lambda)(1 - \varepsilon(\lambda)) \quad (\text{Eq. 1})$$

In Equation 1,  $\lambda$  is wavelength,  $R_{obs}$  is the observed top-of-atmosphere (TOA) radiance,  $R_{clr}$  is the TOA clear sky radiance.  $R_{ac}$  and  $t_{ac}$  are the above cloud to TOA upwelling atmospheric radiance and transmittance, respectively.  $B$  is the Planck Function, and  $T_{eff}$  is the effective cloud temperature. The effective cloud emissivity (Cox, 1976) is given by  $\varepsilon$ . To avoid using additional symbols, the angular dependence is simply implied. Equation 1, while commonly used, is derived step by step in Pavolonis (2010a), if interested.

Equation 1 can readily be solved for the effective cloud emissivity as follows:

$$\varepsilon(\lambda) = \frac{R_{obs}(\lambda) - R_{clr}(\lambda)}{[B(\lambda, T_{eff})t_{ac}(\lambda) + R_{ac}(\lambda)] - R_{clr}(\lambda)} \quad (\text{Eq. 2})$$

In Equation 2, the term in brackets in the denominator is the blackbody cloud radiance that is transmitted to the TOA plus the above cloud (ac) atmospheric radiance. This term is dependent upon the effective cloud vertical location. The cloud vertical location dependence will be discussed in detail in later sections. Other than  $R_{obs}(\lambda)$ , the information needed to evaluate this expression is provided by the output from the clear sky radiative transfer model described in the AIADD Document.

The cloud microphysical signature cannot be captured with the effective cloud emissivity alone for a single spectral channel or wavelength. It is the spectral variation of the effective cloud emissivity that holds the cloud microphysical information. To harness this information, the effective cloud emissivity is used to calculate effective absorption optical depth ratios; otherwise known as  $\beta$ -ratios (see Inoue 1987; Parol et al., 1991; Giraud et al., 1997; and Heidinger and Pavolonis, 2009). For a given pair of spectral emissivities ( $\varepsilon(\lambda_1)$  and  $\varepsilon(\lambda_2)$ ):

$$\beta_{obs} = \frac{\ln[1 - \varepsilon(\lambda_1)]}{\ln[1 - \varepsilon(\lambda_2)]} = \frac{\tau_{abs}(\lambda_1)}{\tau_{abs}(\lambda_2)} \quad (\text{Eq. 3})$$

Notice that Equation 3 can simply be interpreted as the ratio of effective absorption optical depth ( $\tau$ ) at two different wavelengths. The word “effective” is used since the cloud emissivity depends upon the effective cloud temperature. The effective cloud temperature is most often different from the thermodynamic cloud top temperature since the cloud emission originates from a layer in the cloud. The depth of this layer depends upon the cloud transmission profile, which is generally unknown. One must also consider that the effects of cloud scattering are implicit in the cloud emissivity calculation since the actual observed radiance will be influenced by cloud scattering to some degree. In other words, no attempt is made to separate the effects and absorption and scattering. At wavelengths in the 10 to 13  $\mu\text{m}$  range, the effects of cloud scattering for upwelling radiation are quite small and usually negligible. But at infrared wavelengths in the 8 – 10  $\mu\text{m}$  range, the cloud reflectance can make a 1 – 3% contribution to the top of atmosphere radiance (Turner, 2005). Thus, it is best to think of satellite-derived effective cloud emissivity as a radiometric parameter, which, in most cases, is proportional to the fraction of radiation incident on the cloud base that is absorbed by the cloud. See Cox (1976) for an in depth explanation of effective cloud emissivity.

An appealing quality of  $\beta_{obs}$ , is that it can be interpreted in terms of the single scatter properties, which can be computed for a given cloud composition and particle distribution. Following Van de Hulst (1980) and Parol et al. (1991), a spectral ratio of scaled extinction coefficients can be calculated from the single scatter properties (single scatter albedo, asymmetry parameter, and extinction cross section), as follows.



$$\beta_{theo} = \frac{[1.0 - \omega(\lambda_1)g(\lambda_1)]\sigma_{ext}(\lambda_1)}{[1.0 - \omega(\lambda_2)g(\lambda_2)]\sigma_{ext}(\lambda_2)} \quad (\text{Eq. 4})$$

In Equation 4,  $\beta_{theo}$  is the spectral ratio of scaled extinction coefficients,  $\omega$  is the single scatter albedo,  $g$  is the asymmetry parameter, and  $\sigma_{ext}$  is the extinction cross section for an assumed particle distribution. At wavelengths in the 8 – 15  $\mu\text{m}$  range, where multiple scattering effects are small,  $\beta_{theo}$ , captures the essence of the cloudy radiative transfer such that,

$$\beta_{obs} \approx \beta_{theo} \quad (\text{Eq. 5})$$

Equation 4, which was first shown to be accurate for observation in the 10 – 12  $\mu\text{m}$  “window” by Parol et al. (1991), only depends upon the single scatter properties. It does not depend upon the observed radiances, cloud height, or cloud optical depth. By using  $\beta$ -ratios as opposed to brightness temperature differences, we are not only accounting for the non-cloud contribution to the radiances, we are also providing a means to tie the observations back to theoretical size distributions. This framework clearly has practical and theoretical advantages over traditional brightness temperature differences. Parol et al. (1991) first showed that Equation 5 is a good approximation. Pavlonis (2010a) also showed that Equation 5 is a good approximation throughout the 10 - 13  $\mu\text{m}$  window. Faster computers and improvements in the efficiency and accuracy of clear sky radiative transfer modeling have allowed for more detailed exploration of the  $\beta$  data space and computation of  $\beta$ -ratios on a global scale. As such, Pavlonis (2010a) and Pavlonis (2010b) showed that  $\beta$ -ratios offer improved sensitivity to cloud phase relative to brightness temperature differences for the same channel pair.

### 3.4.1.2 Cloud Phase Differences in $\beta$ -Space

The 8.5, 11  $\mu\text{m}$  channel pair (ABI Channels 11 and 14) contains the most direct information on cloud phase. From this channel pair, a  $\beta$ -ratio was constructed such that the 11  $\mu\text{m}$  channel is placed in the denominator of Equations 3 and 4. Hereafter, this  $\beta$  is referred to as  $\beta(8.5/11\mu\text{m})$ . The single scatter property relationship (Equation 4) can be used to establish a theoretical relationship for  $\beta(8.5/11\mu\text{m})$  as a function of cloud phase and cloud particle size. Figure 3 shows the  $\beta(8.5/11\mu\text{m})$ , given by the single scatter properties (see Equation 4), for liquid water and ice as a function of the effective particle radius. The single scatter properties of liquid water spheres were calculated using Mie theory. The ice single scatter properties were taken from the Yang et al. (2005) database, assuming a plate habit. Our analysis of the Yang et al. (2005) database indicates that the sensitivity to particle habit is small compared to the sensitivity to composition and particle size, so only a single ice habit is shown for the sake of clarity. From this figure, one can see that liquid water and ice clouds can be distinguished over most of the effective particle radius range. Unlike brightness temperature differences, these  $\beta$  relationships are only a function of the cloud microphysical properties.

An analogous  $\beta$ -ratio can be constructed from the 11, 12  $\mu\text{m}$  (ABI Channels 14 and 15) single scatter properties. This  $\beta$ -ratio, hereafter  $\beta(12/11\mu\text{m})$ , is shown as a function of the effective particle radius in Figure 4. Clearly, this  $\beta$ -ratio contains little to no information on cloud phase.  $\beta(12/11\mu\text{m})$ , however, is sensitive to particle size. This sensitivity will be exploited in the ABI cloud phase/type algorithm to identify opaque clouds. For opaque clouds, the 11- $\mu\text{m}$  brightness temperature is generally a good proxy for the thermodynamic cloud top temperature, which is useful information when inferring cloud phase. For instance, clouds with a cloud top temperature greater than 273 K, the melting point of water at typical atmospheric pressures, cannot contain ice at cloud top. The methodology used to identify opaque clouds from  $\beta(12/11\mu\text{m})$  will be explained in detail in a later section.

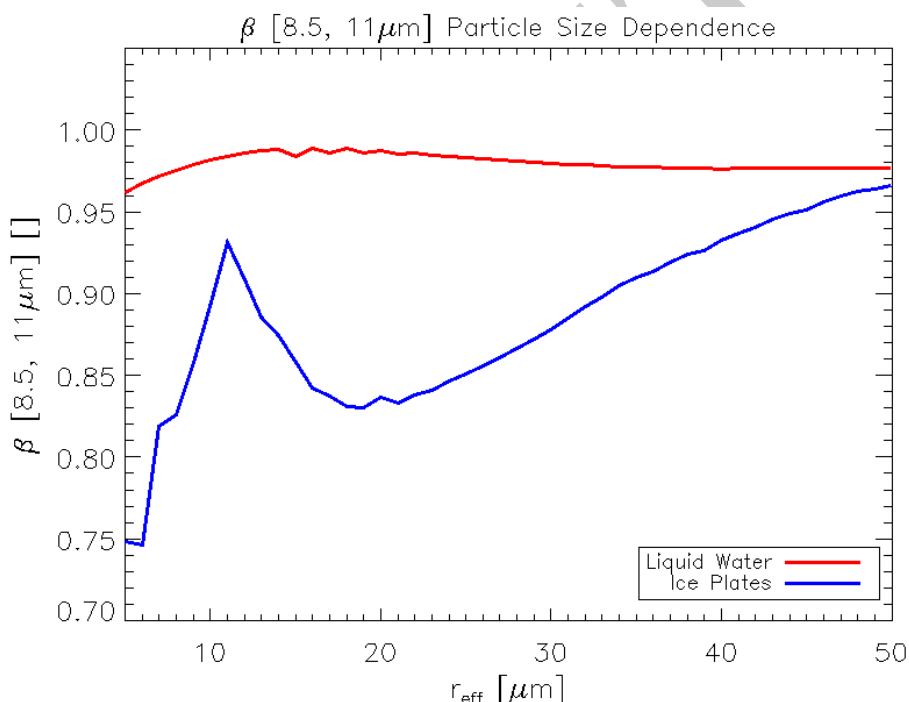

**Figure 3: The 8.5/11  $\mu\text{m}$  scaled extinction ratio ( $\beta(8.5/11\mu\text{m})$ ) is shown as a function of the effective particle radius for liquid water spheres (red) and ice plates (blue). These  $\beta$ -ratios were derived from the single scatter properties.**

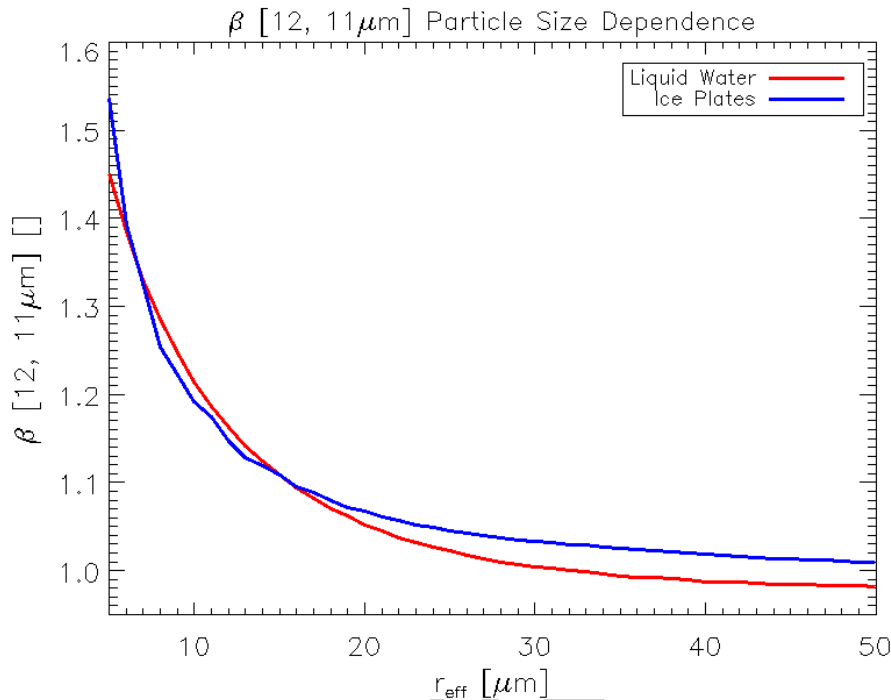

**Figure 4: The 12/11  $\mu\text{m}$  scaled extinction ratio ( $\beta(12/11\mu\text{m})$ ) is shown as a function of the effective particle radius for liquid water spheres (red) and ice plates (blue). These  $\beta$ -ratios were derived from the single scatter properties.**

### 3.4.2 Mathematical Description

These subsections describe in detail how the ACT algorithm is implemented. Firstly, a description of how measured radiances are converted to an emissivity based data space is given. The use of spatial information is explained next, followed by a detailed description of recipe (based on the spectral and spatial “ingredients”) used to determine cloud type and phase.

#### 3.4.2.1 Converting the Measured Radiances to Emissivities and $\beta$ -Ratios

As shown in Section 3.4.1.1, effective cloud emissivity is dependent on the position of the cloud within the vertical column (see Equation 2).

Given the measured radiances at 7.4, 8.5, 11, and 12  $\mu\text{m}$  (ABI channels 10, 11, 14, and 15) and estimates of the clear sky radiance, clear sky transmittance, and the temperature profile, Equations 2 and 3 are used to compute  $\beta$  for the following spectral pairs: (8.5, 11  $\mu\text{m}$ ), (12, 11  $\mu\text{m}$ ), and (7.4, 11  $\mu\text{m}$ ). Given these spectral pairs, the 11  $\mu\text{m}$  emissivity is always placed in the denominator of Equation 3. Hereafter, these  $\beta$ 's are referred to as

$\beta(8.5/11\mu\text{m})$ ,  $\beta(12/11\mu\text{m})$ , and  $\beta(7.4/11\mu\text{m})$ , respectively. The only missing piece of information is the effective cloud vertical level, which is needed in computing the cloud emissivity. The effective cloud vertical level is the level where the temperature profile is equal to the extinction weighted cloud temperature. As shown in Pavolonis (2010a) and Pavolonis (2010b), the sensitivity of  $\beta$  to the effective cloud vertical level is often small when “window” channel pairs are used. As such, cloud microphysical information can be gleaned even by assuming a constant effective cloud vertical level. The retrieval of the actual effective cloud vertical level is unnecessary for this application and beyond the scope of this algorithm. In addition, the cloud phase must also be known to properly constrain the cloud microphysics in a formal retrieval of the cloud vertical level. That is why the cloud phase/type algorithm must work in the absence of cloud height information (e.g. the cloud height retrieval depends on the cloud phase). To mitigate this limitation in the ABI cloud phase/type algorithm, four different cloud vertical level formulations are applied to Equation 2. These assumptions are given the following names.

1. Single layer tropopause assumption
2. Multilayered tropopause assumption
3. Single layer opaque cloud assumption
4. Multilayered opaque cloud assumption

The aim of applying these four assumptions is to probe the  $\beta$  data space for cloud microphysical information such that cloud type can be accurately inferred for non-opaque and opaque clouds, under single and multilayered cloudy conditions.

#### **3.4.2.1.1 Single Layer Tropopause Assumption**

The first formulation assumes a constant effective cloud level consistent with the thermodynamic tropopause given by Numerical Weather Prediction (NWP) data (see the AIADD Document for more information). Equations 6a – 6g specifically show how this assumption is applied to Equations 2 and 3 for the channel pairs used in the cloud type algorithm. In these equations,  $\epsilon_{\text{stropo}}(\lambda)$  is the spectral cloud emissivity computed using the single layer tropopause assumption, and  $\beta_{\text{stropo}}(\lambda_1/\lambda_2)$  represents the  $\beta$  calculated from this type of cloud emissivity.  $T_{\text{tropo}}$  is the temperature of the tropopause.  $R_{\text{tropo}}(\lambda)$  and  $t_{\text{tropo}}(\lambda)$  are the clear sky atmospheric radiance and transmittance, vertically integrated from the tropopause to the top of the atmosphere, respectively (the calculation of the clear sky radiance and transmittance are described in detail in the AIADD Document). All other terms were defined previously. This formulation is primarily used to determine the cloud type/phase of single layer optically thin clouds.

$$\epsilon_{\text{stropo}}(7.4\mu\text{m}) = \frac{R_{\text{obs}}(7.4\mu\text{m}) - R_{\text{ctr}}(7.4\mu\text{m})}{[B(7.4\mu\text{m}, T_{\text{tropo}})t_{\text{tropo}}(7.4\mu\text{m}) + R_{\text{tropo}}(7.4\mu\text{m})] - R_{\text{ctr}}(7.4\mu\text{m})} \quad (\text{Eq. 6a})$$

$$\varepsilon_{\text{tropo}}(8.5\mu\text{m}) = \frac{R_{\text{obs}}(8.5\mu\text{m}) - R_{\text{clr}}(8.5\mu\text{m})}{[B(8.5\mu\text{m}, T_{\text{tropo}})t_{\text{tropo}}(8.5\mu\text{m}) + R_{\text{tropo}}(8.5\mu\text{m})] - R_{\text{clr}}(8.5\mu\text{m})} \quad (\text{Eq. 6b})$$

$$\varepsilon_{\text{tropo}}(11\mu\text{m}) = \frac{R_{\text{obs}}(11\mu\text{m}) - R_{\text{clr}}(11\mu\text{m})}{[B(11\mu\text{m}, T_{\text{tropo}})t_{\text{tropo}}(11\mu\text{m}) + R_{\text{tropo}}(11\mu\text{m})] - R_{\text{clr}}(11\mu\text{m})} \quad (\text{Eq. 6c})$$

$$\varepsilon_{\text{tropo}}(12\mu\text{m}) = \frac{R_{\text{obs}}(12\mu\text{m}) - R_{\text{clr}}(12\mu\text{m})}{[B(12\mu\text{m}, T_{\text{tropo}})t_{\text{tropo}}(12\mu\text{m}) + R_{\text{tropo}}(12\mu\text{m})] - R_{\text{clr}}(12\mu\text{m})} \quad (\text{Eq. 6d})$$

$$\beta_{\text{tropo}}(8.5/11\mu\text{m}) = \frac{\ln[1 - \varepsilon_{\text{tropo}}(8.5\mu\text{m})]}{\ln[1 - \varepsilon_{\text{tropo}}(11\mu\text{m})]} \quad (\text{Eq. 6e})$$

$$\beta_{\text{tropo}}(12/11\mu\text{m}) = \frac{\ln[1 - \varepsilon_{\text{tropo}}(12\mu\text{m})]}{\ln[1 - \varepsilon_{\text{tropo}}(11\mu\text{m})]} \quad (\text{Eq. 6f})$$

$$\beta_{\text{tropo}}(7.4/11\mu\text{m}) = \frac{\ln[1 - \varepsilon_{\text{tropo}}(7.4\mu\text{m})]}{\ln[1 - \varepsilon_{\text{tropo}}(11\mu\text{m})]} \quad (\text{Eq. 6g})$$

### 3.4.2.1.2 Multilayered Tropopause Assumption

Similar to the first formulation, the second cloud vertical level formulation assumes that the cloud vertical level is the tropopause level (given by NWP). Unlike the first formulation, this one includes an additional twist. In this formulation, the clear sky top-of-atmosphere radiance is replaced by the top-of-atmosphere radiance originating from a black (e.g. emissivity = 1.0 at all wavelengths) elevated surface. The elevated black surface is used to roughly approximate a blackbody cloud in the lower troposphere. The black surface is placed at the 0.8 sigma level in a terrain following coordinate system. The ability to detect multilayered clouds with infrared measurements is predicated on the lower cloud layer being colder than the surface and the upper cloud layer being colder than the lower cloud layer (Pavolonis and Heidinger, 2004). The 0.8 sigma level was chosen as a compromise of these two factors. The pressure level ( $P_{\text{black}}$ ) of this black surface is given by Equation 7. In Equation 7,  $\sigma = 0.8$ ,  $P_{\text{surface}}$  is the pressure of the [surface](#) level in the NWP atmospheric pressure profile, and  $P_{\text{toa}}$  is the pressure at the highest level in the NWP atmospheric pressure profile. The sigma coordinate system is commonly used in dynamical models. The purpose of this formulation is to help identify multilayered cloud systems and determine the cloud phase of the highest cloud layer in a multilayered cloud system. Equations 8a – 8g specifically show how this assumption is applied to Equations 2 and 3 for the channel pairs used in the cloud phase/type algorithm. In these equations,  $\varepsilon_{\text{mtropo}}(\lambda)$  is the spectral cloud emissivity computed using this formulation, and  $\beta_{\text{mtropo}}(\lambda_1/\lambda_2)$  represents the  $\beta$  calculated from this type of cloud emissivity.  $T_{\text{black}}$  is the temperature at the pressure level,  $P_{\text{black}}$ .  $R_{\text{black}}(\lambda)$  and  $t_{\text{black}}(\lambda)$  are the clear sky atmospheric radiance and transmittance, vertically integrated from the level

TC 3/4/11 10:25 AM

Deleted: lowest

where the atmospheric pressure is equal to  $P_{black}$  to the top of the atmosphere, respectively. The  $R_{black}(\lambda)$  and  $t_{black}(\lambda)$  terms are simply pulled from pre-calculated profiles of clear sky atmospheric radiance and transmittance using the profile level returned by a standard generic binary search routine when the atmospheric pressure profile is searched for  $P_{black}$  (e.g. no interpolation is performed). The derivation of the pre-calculated clear sky atmospheric radiance and transmittance profiles is described in detail in the AIADD Document. All other terms in Equation 81 – 8g were previously defined.

$$P_{black} = (P_{surface} - P_{toa})\sigma + P_{toa} \quad (\text{Eq. 7})$$

$$\varepsilon_{mtropo}(7.4\mu m) = \frac{R_{obs}(7.4\mu m) - [B(7.4\mu m, T_{black})t_{black}(7.4\mu m) + R_{black}(7.4\mu m)]}{[B(7.4\mu m, T_{tropo})t_{tropo}(7.4\mu m) + R_{tropo}(7.4\mu m)] - [B(7.4\mu m, T_{black})t_{black}(7.4\mu m) + R_{black}(7.4\mu m)]} \quad (\text{Eq. 8a})$$

$$\varepsilon_{mtropo}(8.5\mu m) = \frac{R_{obs}(8.5\mu m) - [B(8.5\mu m, T_{black})t_{black}(8.5\mu m) + R_{black}(8.5\mu m)]}{[B(8.5\mu m, T_{tropo})t_{tropo}(8.5\mu m) + R_{tropo}(8.5\mu m)] - [B(8.5\mu m, T_{black})t_{black}(8.5\mu m) + R_{black}(8.5\mu m)]} \quad (\text{Eq. 8b})$$

$$\varepsilon_{mtropo}(11\mu m) = \frac{R_{obs}(11\mu m) - [B(11\mu m, T_{black})t_{black}(11\mu m) + R_{black}(11\mu m)]}{[B(11\mu m, T_{tropo})t_{tropo}(11\mu m) + R_{tropo}(11\mu m)] - [B(11\mu m, T_{black})t_{black}(11\mu m) + R_{black}(11\mu m)]} \quad (\text{Eq. 8c})$$

$$\varepsilon_{mtropo}(12\mu m) = \frac{R_{obs}(12\mu m) - [B(12\mu m, T_{black})t_{black}(12\mu m) + R_{black}(12\mu m)]}{[B(12\mu m, T_{tropo})t_{tropo}(12\mu m) + R_{tropo}(12\mu m)] - [B(12\mu m, T_{black})t_{black}(12\mu m) + R_{black}(12\mu m)]} \quad (\text{Eq. 8d})$$

$$\beta_{mtropo}(8.5/11\mu m) = \frac{\ln[1 - \varepsilon_{mtropo}(8.5\mu m)]}{\ln[1 - \varepsilon_{mtropo}(11\mu m)]} \quad (\text{Eq. 8e})$$

$$\beta_{mtropo}(12/11\mu m) = \frac{\ln[1 - \varepsilon_{mtropo}(12\mu m)]}{\ln[1 - \varepsilon_{mtropo}(11\mu m)]} \quad (\text{Eq. 8f})$$

$$\beta_{mtropo}(7.4/11\mu m) = \frac{\ln[1 - \varepsilon_{mtropo}(7.4\mu m)]}{\ln[1 - \varepsilon_{mtropo}(11\mu m)]} \quad (\text{Eq. 8g})$$

### 3.4.2.1.3 Single Layer Opaque Assumption

This formulation uses the opaque cloud assumption discussed in Pavolonis (2010a). In this case, the effective cloud vertical level is taken to be the level where either the 8.5, 11, or 12  $\mu\text{m}$  cloud emissivity is equal to 0.98. The 7.4  $\mu\text{m}$  channel is not used in this formulation. This formulation is used to determine the cloud phase of optically thin and thick clouds and infer information on cloud opacity. The process for implementing this formulation is as follows.

1. For a given channel (8.5, 11, and 12  $\mu\text{m}$ ), Equation 2 is rearranged to solve for the black cloud radiance term,  $R_{\text{cld}}(\lambda)$ , that is needed to yield a cloud emissivity of 0.98. Equation 9 shows this rearrangement. In this assumption, the cloud emissivity,  $\varepsilon(\lambda)$ , in Equation 9 is set to 0.98.

$$R_{\text{cld}}(\lambda) = \frac{R_{\text{obs}}(\lambda) + R_{\text{clr}}(\lambda)[\varepsilon(\lambda) - 1]}{\varepsilon(\lambda)} \quad (\text{Eq. 9}) \text{ where}$$

$$R_{\text{cld}}(\lambda) = B(\lambda, T_{\text{eff}})I_{\text{ac}}(\lambda) + R_{\text{ac}}(\lambda) \quad (\text{Eq. 10})$$

2. For a given channel, the  $R_{\text{cld}}(\lambda)$  calculated in Step 1 is compared to a pre-calculated vertical profile of  $R_{\text{cld}}(\lambda)$  for the same channel (see the AIADD Document). The profile of  $R_{\text{cld}}(\lambda)$  is used to determine the weight and anchor points needed to linearly interpolate the profile of  $R_{\text{cld}}(\lambda)$  to the value calculated using Equation 9 with the assumption that  $\varepsilon(\lambda) = 0.98$ . Equation 11 shows how the interpolation weight,  $W(\lambda, 0.98)$ , is determined.

$$W(\lambda, 0.98) = \frac{R_{\text{cld}}(\lambda, 0.98) - R_{\text{cld}}(\lambda, Z_1)}{R_{\text{cld}}(\lambda, Z_2) - R_{\text{cld}}(\lambda, Z_1)} \quad (\text{Eq. 11})$$

In Equation 11,  $R_{\text{cld}}(\lambda, 0.98)$  is the value calculated using Equation 9 with the assumption that  $\varepsilon(\lambda) = 0.98$ .  $R_{\text{cld}}(\lambda, Z_1)$  and  $R_{\text{cld}}(\lambda, Z_2)$  are the black cloud radiances within the vertical profile that bound  $R_{\text{cld}}(\lambda, 0.98)$ , with  $R_{\text{cld}}(\lambda, Z_1)$  being the black cloud radiance at the highest (e.g. furthest from the ground) bounding level ( $Z_1$ ).  $Z_1$  and  $Z_2$  are the vertical array indices corresponding to the interpolation anchor points.

3. Steps 1 and 2 are performed for the 8.5, 11, and 12  $\mu\text{m}$  channels. The interpolation weights and anchor points associated with each channel are used to determine which  $R_{\text{cld}}(\lambda, 0.98)$  occurs at the highest (e.g. furthest from the ground) vertical level.
4. Once it is determined for which channel  $R_{\text{cld}}(\lambda, 0.98)$  occurs at the highest vertical level, the interpolation weight and anchor points for that channel are used to interpolate the  $R_{\text{cld}}(\lambda)$  of the other two channels to that same level. The highest level is chosen to prevent the cloud emissivity in any of the channels from becoming too large (e.g.  $> 1.0$ ). Thus, the cloud emissivity is fixed at 0.98 for the

channel where an emissivity of 0.98 occurs at the highest vertical level. This channel is referred to as the reference channel. The interpolation of  $R_{\text{cld}}(\lambda)$  for the non-reference channels is performed according to Equation 12. Note that by interpolating  $R_{\text{cld}}(\lambda)$ , for the non-reference channels, to the level where the  $R_{\text{cld}}(\lambda)$  of the reference channel gives an emissivity equal to 0.98, allows the emissivity of the non-reference channels to deviate from 0.98. Recall that cloud microphysical information is related to the spectral variation of cloud emissivity. In Equation 12,  $R_{\text{cld\_int}}(\lambda)$  is the upwelling black cloud radiance interpolated using the reference weight  $[W(\lambda_{\text{ref}}, 0.98)]$  and reference anchor points  $[R_{\text{cld}}(\lambda_{\text{ref}}, Z_{\text{ref}1})$  and  $R_{\text{cld}}(\lambda_{\text{ref}}, Z_{\text{ref}2})]$  that give a cloud emissivity of 0.98 at the reference channel.  $Z_{\text{ref}1}$  and  $Z_{\text{ref}2}$  are the vertical array indices of the reference interpolation anchor points.

$$R_{\text{cld\_int}}(\lambda) = R_{\text{cld}}(\lambda, Z_{\text{ref}1}) + W(\lambda_{\text{ref}}, 0.98)[R_{\text{cld}}(\lambda, Z_{\text{ref}2}) - R_{\text{cld}}(\lambda, Z_{\text{ref}1})] \quad (\text{Eq. 12})$$

5. Finally, the 8.5, 11, and 12  $\mu\text{m}$  channel cloud emissivities are computed using Equations 13a – 13c.  $\beta(8.5/11\mu\text{m})$  and  $\beta(12/11\mu\text{m})$  are also computed using Equations 13d and 13e. In these equations,  $\epsilon_{\text{sopaque}}(\lambda)$  is the spectral cloud emissivity computed using the single layer opaque cloud assumption, and  $\beta_{\text{sopaque}}(\lambda_1/\lambda_2)$  represents the  $\beta$  calculated from this type of cloud emissivity. If this formulation is implemented correctly,  $\epsilon_{\text{sopaque}}(\lambda)$  at the reference channel should be equal to 0.98.

$$\epsilon_{\text{sopaque}}(8.5\mu\text{m}) = \frac{R_{\text{obs}}(8.5\mu\text{m}) - R_{\text{clr}}(8.5\mu\text{m})}{R_{\text{cld\_interp}}(8.5\mu\text{m}) - R_{\text{clr}}(8.5\mu\text{m})} \quad (\text{Eq. 13a})$$

$$\epsilon_{\text{sopaque}}(11\mu\text{m}) = \frac{R_{\text{obs}}(11\mu\text{m}) - R_{\text{clr}}(11\mu\text{m})}{R_{\text{cld\_interp}}(11\mu\text{m}) - R_{\text{clr}}(11\mu\text{m})} \quad (\text{Eq. 13b})$$

$$\epsilon_{\text{sopaque}}(12\mu\text{m}) = \frac{R_{\text{obs}}(12\mu\text{m}) - R_{\text{clr}}(12\mu\text{m})}{R_{\text{cld\_interp}}(12\mu\text{m}) - R_{\text{clr}}(12\mu\text{m})} \quad (\text{Eq. 13c})$$

$$\beta_{\text{sopaque}}(8.5/11\mu\text{m}) = \frac{\ln[1 - \epsilon_{\text{sopaque}}(8.5\mu\text{m})]}{\ln[1 - \epsilon_{\text{sopaque}}(11\mu\text{m})]} \quad (\text{Eq. 13d})$$

$$\beta_{\text{sopaque}}(12/11\mu\text{m}) = \frac{\ln[1 - \epsilon_{\text{sopaque}}(12\mu\text{m})]}{\ln[1 - \epsilon_{\text{sopaque}}(11\mu\text{m})]} \quad (\text{Eq. 13e})$$

#### 3.4.2.1.4 Multilayered Opaque Cloud Assumption

This assumption is implemented in exactly the same manner as the “Single Layer Opaque Cloud Assumption” except the top-of-atmosphere clear sky radiance is replaced by the top-of-atmosphere radiance originating from a black elevated surface. Just as in the



“Multilayered Tropopause Assumption,” the black surface is placed at the 0.8 sigma level in a terrain following coordinate system. The black elevated surface is explained in detail in Section 3.4.2.1.2. As explained in a later section, the “Multilayered Opaque Cloud Assumption” is used to detect multilayered cloud systems. In this formulation, the 8.5, 11, and 12  $\mu\text{m}$  channel cloud emissivities are computed using Equations 14a – 14c (the 7.4  $\mu\text{m}$  channel is not used in this formulation).  $\beta(8.5/11\mu\text{m})$  and  $\beta(12/11\mu\text{m})$  are also computed using Equations 14d and 14e. In these equations,  $\epsilon_{\text{mopaque}}(\lambda)$  is the spectral cloud emissivity computed using the multilayered opaque cloud assumption, and  $\beta_{\text{mopaque}}(\lambda_1/\lambda_2)$  represents the  $\beta$  calculated from this type of cloud emissivity.

$$\epsilon_{\text{mopaque}}(8.5\mu\text{m}) = \frac{R_{\text{obs}}(8.5\mu\text{m}) - [B(8.5\mu\text{m}, T_{\text{black}})t_{\text{black}}(8.5\mu\text{m}) + R_{\text{black}}(8.5\mu\text{m})]}{R_{\text{cld\_interp}}(8.5\mu\text{m}) - [B(8.5\mu\text{m}, T_{\text{black}})t_{\text{black}}(8.5\mu\text{m}) + R_{\text{black}}(8.5\mu\text{m})]} \quad (\text{Eq. 14a})$$

$$\epsilon_{\text{mopaque}}(11\mu\text{m}) = \frac{R_{\text{obs}}(11\mu\text{m}) - [B(11\mu\text{m}, T_{\text{black}})t_{\text{black}}(11\mu\text{m}) + R_{\text{black}}(11\mu\text{m})]}{R_{\text{cld\_interp}}(11\mu\text{m}) - [B(11\mu\text{m}, T_{\text{black}})t_{\text{black}}(11\mu\text{m}) + R_{\text{black}}(11\mu\text{m})]} \quad (\text{Eq. 14b})$$

$$\epsilon_{\text{mopaque}}(12\mu\text{m}) = \frac{R_{\text{obs}}(12\mu\text{m}) - [B(12\mu\text{m}, T_{\text{black}})t_{\text{black}}(12\mu\text{m}) + R_{\text{black}}(12\mu\text{m})]}{R_{\text{cld\_interp}}(12\mu\text{m}) - [B(12\mu\text{m}, T_{\text{black}})t_{\text{black}}(12\mu\text{m}) + R_{\text{black}}(12\mu\text{m})]} \quad (\text{Eq. 14c})$$

$$\beta_{\text{mopaque}}(8.5/11\mu\text{m}) = \frac{\ln[1 - \epsilon_{\text{mopaque}}(8.5\mu\text{m})]}{\ln[1 - \epsilon_{\text{mopaque}}(11\mu\text{m})]} \quad (\text{Eq. 14d})$$

$$\beta_{\text{mopaque}}(12/11\mu\text{m}) = \frac{\ln[1 - \epsilon_{\text{mopaque}}(12\mu\text{m})]}{\ln[1 - \epsilon_{\text{mopaque}}(11\mu\text{m})]} \quad (\text{Eq. 14e})$$

### 3.4.2.2 Opaque Cloud Temperature

The opaque cloud temperature is defined as the temperature at the vertical level where the cloud emissivity for a given channel is equal to a near-opaque value (0.98 in this case). The opaque cloud temperature is useful for determining the atmospherically corrected cloud-top temperature of opaque/near-opaque clouds. In addition, the opaque cloud temperature derived from a window channel can be compared to the opaque cloud temperature derived from an absorption channel to infer information about cloud optical depth. The ABI Cloud Type Algorithm computes the opaque cloud temperature for the 7.4  $\mu\text{m}$  (ABI channel 10) and 11  $\mu\text{m}$  (ABI channel 14) channels. The process for calculating the opaque cloud temperature is as follows.

If the clear sky radiance of a given channel is greater than the observed radiance for that same channel, the following procedure is used to determine the opaque cloud temperature. For a given channel (7.4 and 11  $\mu\text{m}$ ), Equation 2 is rearranged to solve for the black cloud radiance term,  $R_{\text{cld}}(\lambda)$ , that is needed to yield a cloud emissivity of 0.98. Equation 9 shows this rearrangement. In this assumption, the cloud emissivity,  $\epsilon(\lambda)$ , in

Equation 9 is set to 0.98. The vertical level returned by a standard generic binary search routine is used to locate the value of  $R_{\text{clid}}(\lambda)$ , computed using Equation 9, in the pre-computed vertical profile of  $R_{\text{clid}}(\lambda)$ . The vertical array index returned by the binary search routine is used to grab the opaque cloud temperature from the NWP temperature profile (e.g. no interpolation is performed). As described in the AIADD Document,  $R_{\text{clid}}(\lambda)$  and NWP temperature need to be available at the same vertical levels. This procedure is applied twice to separately determine the 7.4  $\mu\text{m}$  and 11  $\mu\text{m}$  opaque cloud temperatures,  $T_{\text{opaque}}(7.4\mu\text{m})$  and  $T_{\text{opaque}}(11\mu\text{m})$ , respectively. If the 11  $\mu\text{m}$  clear sky radiance is less than the observed radiance (e.g. due to errors in the clear radiance or if the cloud is warmer than the surface), then  $T_{\text{opaque}}(11\mu\text{m})$  is set to the observed 11  $\mu\text{m}$  brightness temperature. If the 7.4  $\mu\text{m}$  clear sky radiance is less than the observed radiance, then  $T_{\text{opaque}}(7.4\mu\text{m})$  is set to -999.0.

To determine the cloud type, the radiative parameters (“the ingredients”) computed from all of the formulations described in Sections 3.4.2.1 and 3.4.2.2 are used in a logical decision tree (the “recipe”). Prior to describing the decision tree, the use of spatial information in the cloud type/phase algorithm must be explained.

### 3.4.2.3 Median Spatial Filter

The emissivity and  $\beta$  calculations described in Section 3.4.2.1 can, at times, be noisy, especially near cloud edges, in areas of broken clouds, and for very small cloud optical depths. In order to minimize the occurrence of “salt and pepper” noise, a standard 3 x 3 median filter is applied to certain key variables ( $\epsilon_{\text{stropo}}(11\mu\text{m})$ ,  $\beta_{\text{stropo}}(8.5/11\mu\text{m})$ ,  $\beta_{\text{sopaque}}(8.5/11\mu\text{m})$ ,  $\beta_{\text{stropo}}(12/11\mu\text{m})$ , and  $\beta_{\text{sopaque}}(12/11\mu\text{m})$ ). The median filter simply replaces the value at each pixel with the median value of a 3 x 3 pixel array centered on that pixel. The generic median filter procedure is described in the AIADD Document.

### 3.4.2.4 Identifying a Pixel’s Local Radiative Center

In regions where the radiative signal of a cloud is small, like cloud edges, the various  $\beta$ -ratios are difficult to interpret since the cloud fraction, which is assumed to be 1.0, may be less than 1.0, or very small cloud optical depths may produce a signal that cannot be differentiated from noise. With the spectral information limited, a spatial metric is needed to make a spatially and physically consistent cloud type determination for these types of pixels. To address this problem, the gradient filter procedure, which is described in detail in the AIADD Document, is used to determine the Local Radiative Center (LRC) of each pixel valid pixel. A pixel is valid if it has a valid Earth latitude and longitude and has valid spectral data (based on the L1b calibration flags). The  $\epsilon_{\text{stropo}}(11\mu\text{m})$  parameter described in Section 3.4.2.1.1 is used to compute the LRC. The gradient filter inputs (which are described in detail in the AIADD Document) for this application are listed in Table 4.

Gradient Variable	Minimum Valid Value of Gradient Variable	Maximum Valid Value of Gradient Variable	Gradient Stop Value	Apply Gradient Filter To
$\epsilon_{\text{stropo}}(11\mu\text{m})$	0.0	1.0	0.7	All pixels with a valid Earth lat/lon and valid spectral data for ABI channels 10, 11, 14, and 15

**Table 4: Inputs used in calculation of Local Radiative Center (LRC). The gradient filter function used in the calculation is described in the AIADD document.**

The gradient filter allows one to consult the spectral information at an interior pixel within the same cloud in order to avoid using the spectral information offered by pixels with a very weak cloud radiative signal or sub-pixel cloudiness associated with cloud edges. Figure 5 shows how this technique eliminates anomalous  $\beta_{\text{stropo}}(8.5/11\mu\text{m})$  values at cloud edges. Overall, this use of spatial information allows for a more spatially and physically consistent product. This concept is also explained in Pavolonis (2010b).

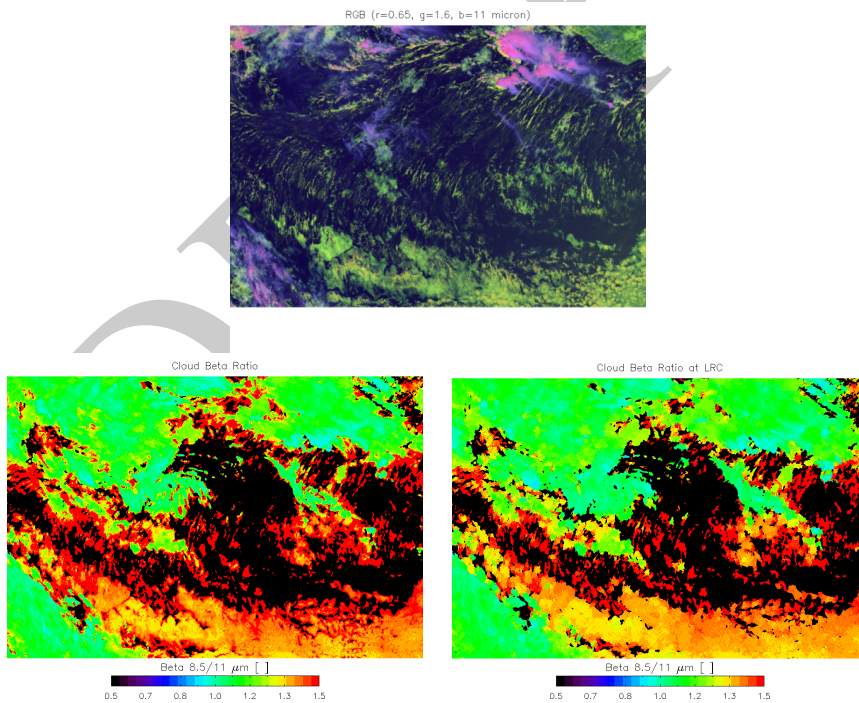

**Figure 5: The impact of the gradient filter is shown for the scene depicted by the false color RGB image (top). The  $\beta_{\text{stropo}}(8.5/11\mu\text{m})$  at each pixel is shown in the bottom, left panel and the bottom, right panel is the same as the bottom left, except**

the  $\beta_{\text{tropo}}(8.5/11\mu\text{m})$  for the LRC of each pixel is shown. Notice how anomalous values near cloud edges are absent from the LRC image.

### 3.4.2.5 Use of Spaceborne Lidar and Near-Infrared Reflectance Data to Determine Algorithm Thresholds

The Cloud-Aerosol Lidar with Orthogonal Polarization (CALIOP) on-board the Cloud-Aerosol Lidar and Infrared Pathfinder Satellite Observation (CALIPSO) satellite is a nadir pointing dual wavelength depolarization lidar. CALIPSO is in an afternoon sun-synchronous low earth orbit. Thus, it can be closely co-located in space and time with the Spinning Enhanced Visible and Infrared Imager (SEVIRI) at certain times of the day. SEVIRI has 7.4, 8.5, 11, and 12  $\mu\text{m}$  channels that are similar to the ABI and CALIOP is capable of accurately measuring cloud boundaries in the vertical and horizontal. The vertical cloud boundaries can be combined with co-located NWP temperature profiles to provide a good estimate of cloud top temperature, which can be used to infer cloud top phase for certain temperature ranges. The CALIOP cloud phase product is not used at this time because the current version is not accurate due to the complexities of multiple scattering and oriented ice crystals (Hu et al., 2009). The next version of the CALIOP cloud phase product should address some of these deficiencies (Hu et al., 2009). The CALIOP cloud boundaries can also be used to calculate a quality estimate of the true cloud emissivity, as in Heidinger and Pavolonis (2009). In developing the ABI cloud type/phase algorithm, CALIOP and SEVIRI co-locations were used extensively to help define thresholds, verify physical concepts, and validate the algorithm. In addition, near infrared reflectance data (available during the day), which are not used in the cloud type/phase algorithm, were used to adjust thresholds. In the near-infrared, ice is more absorbing than liquid water, thus, ice will generally have a smaller reflectance than liquid water (Pavolonis et al., 2005).

### 3.4.2.6 Cloud Phase/Type Determination

As stated earlier, the cloud phase is determined from the cloud type output (the cloud phase product is a subset of the more detailed cloud type categories). The cloud type decision tree is composed of several small components (or tests), each aimed at extracting specific information related to cloud type. The algorithm first determines the result of each test and stores that information. Thereafter, the results of the tests are examined in a specific order to determine the cloud type. The following sections will describe each test and the logic used to determine the cloud type from the test results. Please note that all of the inputs needed by the cloud type decision tree (including mathematical symbols) have been defined in previous sections. As a reminder, the overall algorithm processing flow chart is shown in [Figure 1](#).

#### 3.4.2.6.1 Low Surface Emissivity (LSE) Test

**Purpose:** Determine if certain downstream tests may be negatively impacted by low surface emissivity.

**Inputs:**

- $8.5 \mu\text{m}$  (ABI channel 11) surface emissivity [ $\epsilon_{\text{sfc}}(8.5\mu\text{m})$ ]
- $\epsilon_{\text{stropo}}(11\mu\text{m})$

**Logic:**

**If** ( $\epsilon_{\text{sfc}}(8.5\mu\text{m}) < \text{LSE\_Threshold\_1}$  **AND**  $\epsilon_{\text{stropo}}(11\mu\text{m}) < \text{LSE\_Threshold\_2}$ )

Output = TRUE (a low surface emissivity is present)

**Else**

Output = FALSE

**Thresholds and rationale:**

Offline radiative transfer model simulations indicate that once the  $8.5 \mu\text{m}$  surface emissivity decreases to about 0.85, the opaque cloud assumption described in Section 3.4.2.1.3 is no longer effective for determining cloud phase or cloud opacity, unless the  $\epsilon_{\text{stropo}}(11\mu\text{m})$  exceeds a certain threshold. The thresholds required by the LSE test are listed in Table 5.

Sensor	LSE Threshold 1	LSE Threshold 2
Met-8 SEVIRI	0.85	0.50
Met-9 SEVIRI	0.85	0.50
Terra MODIS	0.85	0.50
Aqua MODIS	0.85	0.50
GOES-R ABI	0.85	0.50

**Table 5: The thresholds used by the Low Surface Emissivity (LSE) Test as a function of sensor.**

**3.4.2.6.2  $\beta(12/11\mu\text{m})$  Opaque Cloud (BOC) Test**

**Purpose:** Determine if a cloud is opaque/nearly opaque using the theory described in Pavolonis (2010a).

**Inputs:**

- $\epsilon_{\text{stropo}}(11\mu\text{m})$
- $\beta_{\text{sopaque}}(12/11\mu\text{m})$

**Logic:**

**If** ( $\epsilon_{\text{stropo}}(11\mu\text{m}) > \text{BOC\_Threshold\_1}$  **AND**  $\beta_{\text{sopaque}}(12/11\mu\text{m}) < \text{BOC\_Threshold\_2}$ )

Output = TRUE (cloud is nearly opaque)

**Else**

Output = FALSE

**Thresholds and rationale:**

The cloud type/phase algorithm does not need specific values of the actual cloud optical depth or emissivity. Only a flag indicating if the cloud likely has an 11  $\mu\text{m}$  cloud optical depth greater than about 2.0 (see definition of cloud type categories) is needed. In order to determine if a pixel has a high probability of containing an opaque or near-opaque upper-most cloud layer,  $\beta_{\text{sopaque}}(12/11\mu\text{m})$  (see Equation 13e) is examined as in Pavolonis (2010a). If the cloud has a large emissivity (at the reference channel), then the  $\beta_{\text{sopaque}}(12/11\mu\text{m})$  should fall well within the expected theoretical range given by the single scatter properties. If the cloud has an emissivity (at the reference channel) much smaller than 0.98,  $\beta_{\text{sopaque}}(12/11\mu\text{m})$  should be greatly influenced by the spectral variability in surface emissivity and clear sky gaseous transmittance, and thus, may not fall within the expected theoretical range. This is because the upwelling top-of-atmosphere radiance from an elevated (e.g. above the surface) blackbody surface, and the atmosphere above, converges to the clear sky radiance at a higher (colder) atmospheric level for channels that have a small surface emissivity and/or higher peaking weighting function.

The  $\beta_{\text{sopaque}}(12/11\mu\text{m})$  threshold was determined objectively using SEVIRI and CALIOP time/space co-locations, where the goal is to identify clouds that have an 11  $\mu\text{m}$  emissivity greater than 0.85 (roughly equivalent to an 11  $\mu\text{m}$  optical depth of 2.0). CALIOP cloud boundaries were used to compute a “true” 11- $\mu\text{m}$  cloud emissivity. In other words, Equation 2 can be evaluated using the CALIOP cloud boundaries and an NWP temperature profile to estimate the effective cloud level, which is assumed to lie midway between the CALIOP cloud top and cloud bottom (Heidinger and Pavolonis, 2009). Figure 6 shows Peirce-Hanssen-Kuipers skill score metrics as a function of the  $\beta_{\text{sopaque}}(12/11\mu\text{m})$  threshold used to distinguish between clouds with a 11- $\mu\text{m}$  cloud optical depth of less than and greater than 2.0. A total of about 8000 SEVIRI/CALIOP match-ups were used in this analysis. This objective analysis indicates that a threshold of 1.19 is optimal (clouds with a  $\beta_{\text{sopaque}}(12/11\mu\text{m}) < 1.19$  are considered to have an 11  $\mu\text{m}$  optical depth greater than 2.0). The thresholds used by the BOC test are listed in Table 6. Overall, these results prove that opaque/near-opaque clouds can be identified with respectable skill using this approach.

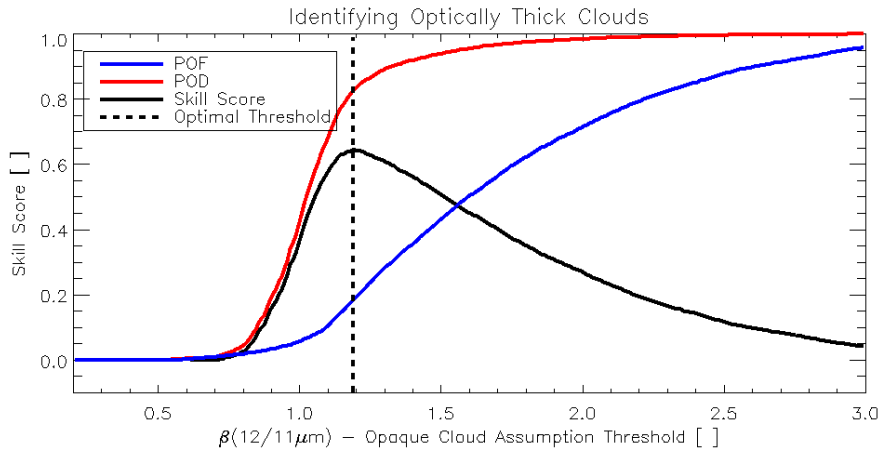

**Figure 6:** Peirce-Hanssen-Kuipers skill score metrics are shown as a function of the  $\beta_{\text{sopaque}}(12/11\mu\text{m})$  threshold used to distinguish between clouds with a  $11\text{-}\mu\text{m}$  cloud optical depth of less than and greater than 2.0. The probability of false alarm (POF) is shown in blue, the probability of detection (POD) is shown in red, and the skill score is depicted by the black solid line. The  $\beta_{\text{sopaque}}(12/11\mu\text{m})$  threshold that maximizes the skill score is depicted by the dashed black line. This analysis is based on over 8000 SEVIRI/CALIOP match-ups.

Sensor	BOC Threshold 1	BOC Threshold 2
Met-8 SEVIRI	0.05	1.19
Met-9 SEVIRI	0.05	1.19
Terra MODIS	0.05	1.17
Aqua MODIS	0.05	1.17
GOES-R ABI	0.05	1.19

**Table 6:** The thresholds used by the  $\beta(12/11\mu\text{m})$  Opaque Cloud (BOC) Test as a function of sensor.

### 3.4.2.6.3 Opaque Cloud Temperature Difference (OCTD) Test

**Purpose:** Determine if a cloud is opaque/nearly opaque using the difference between  $T_{\text{opaque}}(7.4\mu\text{m})$  and  $T_{\text{opaque}}(11\mu\text{m})$ , which were described in Section 3.4.2.2.

**Inputs:**

- $T_{\text{opaque}}(7.4\mu\text{m})$
- $T_{\text{opaque}}(11\mu\text{m})$
- Absolute value of the  $T_{\text{opaque}}(7.4\mu\text{m}) - T_{\text{opaque}}(11\mu\text{m})$  difference [ $T_{\text{opaque}}(\text{diff})$ ]

**Logic:**

If  $(T_{\text{opaque}}(7.4\mu\text{m}) > \text{OCTD\_Threshold\_1} \text{ AND } T_{\text{opaque}}(11\mu\text{m}) > \text{OCTD\_Threshold\_2} \text{ AND } T_{\text{opaque}}(\text{diff}) < \text{OCTD\_Threshold\_3})$

Output = TRUE (cloud is nearly opaque)

**Else**

Output = FALSE

**Thresholds and rational:**

This test is used to supplement the BOC Test. The physical basis is straightforward. If the absolute difference between the opaque cloud temperature derived from the 7.4  $\mu\text{m}$  channel and the opaque cloud temperature derived from the 11  $\mu\text{m}$  channel is small, the cloud approximates a blackbody and is considered to be opaque/nearly opaque. Given that the 7.4  $\mu\text{m}$  channel has a clear sky weighting function that peaks in the middle troposphere and the clear sky weighting function of the 11  $\mu\text{m}$  channel peaks near the surface, only the presence of an opaque/nearly opaque cloud can cause the absolute difference between the opaque cloud temperatures to be small. Figure 7 shows Peirce-Hanssen-Kuipers skill score metrics as a function of the  $T_{\text{opaque}}(\text{diff})$  threshold used to distinguish between clouds with a 11- $\mu\text{m}$  cloud optical depth of less than and greater than 2.0. A total of about 8000 SEVIRI/CALIOP match-ups were used in this analysis. This objective analysis indicates that a threshold of 4.5 K is optimal (clouds with a  $T_{\text{opaque}}(\text{diff}) < 4.5$  K are considered to have an 11  $\mu\text{m}$  optical depth greater than 2.0). The thresholds used by the OCTD test are listed in Table 7.

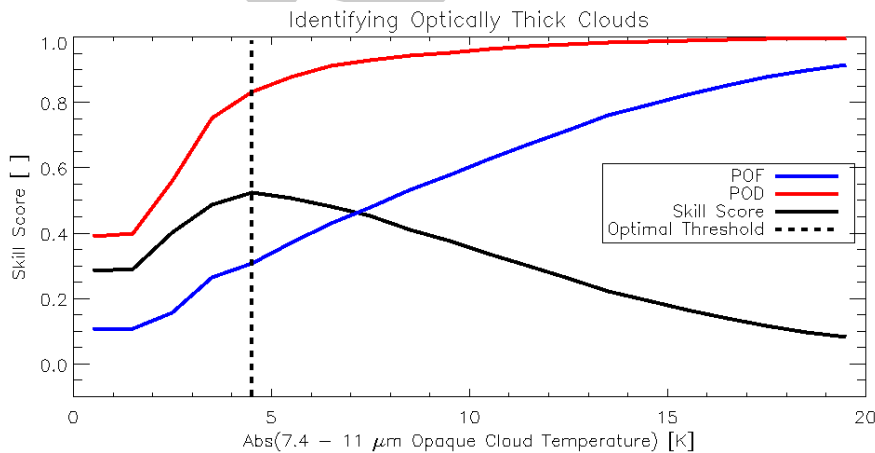

**Figure 7: Peirce-Hanssen-Kuipers skill score metrics are shown as a function of the absolute difference in the 7.4  $\mu\text{m}$  – 11  $\mu\text{m}$  opaque cloud temperature ( $T_{\text{opaque}}(\text{diff})$ )**



threshold used to distinguish between clouds with a 11- $\mu\text{m}$  cloud optical depth of less than and greater than 2.0. The probability of false alarm (POF) is shown in blue, the probability of detection (POD) is shown in red, and the skill score is depicted by the black solid line. The  $T_{\text{opaque}}(\text{diff})$  threshold that maximizes the skill score is depicted by the dashed black line. This analysis is based on over 8000 SEVIRI/CALIOP match-ups.

Sensor	OCTD_Threshold_1 [K]	OCTD_Threshold_2 [K]	OCTD_Threshold_3 [K]
Met-8 SEVIRI	170	170	4.5
Met-9 SEVIRI	170	170	4.5
Terra MODIS	170	170	4.5
Aqua MODIS	170	170	4.5
GOES-R ABI	170	170	4.5

**Table 7: The thresholds used by the Opaque Cloud Temperature Difference (OCTD) Test as a function of sensor.**

#### 3.4.2.6.4 Overall Opaque Cloud (OOC) Test

**Purpose:** Combine the output from the Low Surface Emissivity Test (LSE),  $\beta(12/11\mu\text{m})$  Opaque Cloud (BOC) Test, and the Opaque Cloud Temperature Difference (OCTD) Test to determine if a cloud is truly opaque/nearly opaque.

**Inputs:**

- Result of LSE Test
- Result of BOC Test
- Result of OCTD Test

**Logic:**

If (LSE Test = TRUE)

Output = OCTD Test

Else

Output = BOC Test

**Thresholds and rational:**

The BOC test is generally more skillful than the OCTD test, except over barren low emissivity surfaces. Thus, the output of the BOC test is used, except over low emissivity surfaces.

### 3.4.2.6.5 Water Vapor Multilayered Detection (WVMD) Test

**Purpose:** Detect multilayered cloud systems, where the highest cloud layer is semi-transparent to infrared radiation.

**Inputs:**

- $\epsilon_{\text{stropo}}(7.4\mu\text{m})$
- $\epsilon_{\text{mtropo}}(11\mu\text{m})$
- $\beta_{\text{mtropo}}(7.4/11\mu\text{m})$
- $\beta_{\text{stropo}}(12/11\mu\text{m})$
- $\beta_{\text{mtropo}}(12/11\mu\text{m})$
- $\beta_{\text{mopaque}}(12/11\mu\text{m})$
- $\beta_{\text{sopaque}}(8.5/11\mu\text{m})$  at the pixel Local Radiative Center (LRC)  
[ $\beta_{\text{sopaque}}(8.5/11\mu\text{m})_{\text{LRC}}$ ]

**Logic:**

If ( $\epsilon_{\text{stropo}}(7.4\mu\text{m}) > \text{WVMD\_Thresh1}$  AND  
 $\beta_{\text{mtropo}}(7.4/11\mu\text{m}) > \text{WVMD\_Thresh2}$  AND  
 $\beta_{\text{mtropo}}(7.4/11\mu\text{m}) < \text{WVMD\_Thresh3}$  AND  
 $\beta_{\text{stropo}}(12/11\mu\text{m}) < \beta_{\text{mtropo}}(12/11\mu\text{m})$  AND  
 $\epsilon_{\text{mtropo}}(11\mu\text{m}) > \text{WVMD\_Thresh4}$  AND  
 $\epsilon_{\text{mtropo}}(11\mu\text{m}) < \text{WVMD\_Thresh5}$  AND  
 $\beta_{\text{mopaque}}(12/11\mu\text{m}) > \text{WVMD\_Thresh6}$  AND  
 $\beta_{\text{mopaque}}(12/11\mu\text{m}) < \text{WVMD\_Thresh7}$  AND  
 $\beta_{\text{sopaque}}(8.5/11\mu\text{m})_{\text{LRC}} > \text{WVMD\_Thresh8}$  AND  
 $\beta_{\text{sopaque}}(8.5/11\mu\text{m})_{\text{LRC}} < \text{WVMD\_Thresh9}$ )

Output = TRUE (multilayered clouds are present)

**Else**

Output = FALSE

**Thresholds and rational:**

The multilayered cloud detection methodology is designed to detect semi-transparent upper tropospheric ice clouds that overlap a lower opaque/near-opaque cloud layer. These will be referred to as “multilayered ice clouds” from this point forward. Previous studies (e.g. Heidinger and Pavolonis, 2005) have shown that multilayered ice clouds are a common occurrence. The presence of multiple cloud layers will impact downstream retrievals of cloud macro and microphysical properties, so it is important to identify multilayered cloud systems prior to performing these retrievals. The multilayered cloud detection technique exploits differences in atmospheric weighting functions and

microphysical relationships to infer the presence of multilayered clouds. The 7.4- $\mu\text{m}$  channel (ABI Channel 10) atmospheric weighting function generally peaks in the mid to upper troposphere (the exact peak depends on the water vapor profile), while the 11- $\mu\text{m}$  channel (ABI Channel 14) weighting function peaks in the lower troposphere near the surface.

When a semi-transparent high cloud overlaps an opaque/near-opaque lower tropospheric cloud, the 7.4- $\mu\text{m}$  channel will have little sensitivity to the emission from the lower tropospheric cloud (unless the atmosphere is very dry), while the 11- $\mu\text{m}$  channel will be sensitive to emission from both cloud layers. Thus, the 11- $\mu\text{m}$  cloud emissivity calculated using the “Single Layer Tropopause Assumption” (see Section 3.4.2.1.1) would be much larger than the 7.4- $\mu\text{m}$  emissivity calculated using the same assumptions. If the 7.4- $\mu\text{m}$  and 11- $\mu\text{m}$  cloud emissivities are computed for the same multilayered cloud scenario using the “Multilayered Tropopause Assumption” (see Section 3.4.2.1.2), the following will be result:  $\epsilon_{\text{mtropo}}(11\mu\text{m}) < \epsilon_{\text{stropo}}(11\mu\text{m})$  and  $\epsilon_{\text{mtropo}}(7.4\mu\text{m}) \approx \epsilon_{\text{stropo}}(7.4\mu\text{m})$ . The sigma level ( $\sigma = 0.8$ ) of the lower opaque cloud layer used in the “Multilayered Tropopause Assumption” was chosen such that it was placed well below the peak of the 7.4- $\mu\text{m}$  channel weighting function. Given this physical basis,  $\beta_{\text{mtropo}}(7.4/11\mu\text{m})$  is a fairly good indicator of multilayered ice clouds, especially when supplemented with a few additional pieces of information.

Additional spectral information is used to help verify that a multilayered ice cloud is possible. Additional pieces of information are needed because, in reality, the 7.4- $\mu\text{m}$  channel weighting function varies as a function of atmospheric temperature and water vapor and the height and opacity of the lower cloud layer will vary, which leads to ambiguity. Constraints on  $\epsilon_{\text{mtropo}}(11\mu\text{m})$  and  $\beta_{\text{mopaque}}(12/11\mu\text{m})$  are applied in order to be more certain that the uppermost cloud layer is semi-transparent. Further constraints are applied to the value of  $\beta_{\text{sopaque}}(8.5/11\mu\text{m})$  at the pixel Local Radiative Center (LRC) to help reduce false detects due to certain single layer mid-level clouds. All of the thresholds for the WVMD test are shown in Table 8.

Figure 8 shows the normalized distribution of  $\beta_{\text{mtropo}}(7.4/11\mu\text{m})$  for single layer and multilayered “definite ice clouds.” CALIOP was used to identify single layer clouds with a cloud top temperature of 233 K or less and multilayered cloud systems where the cloud top temperature of the highest cloud layer is 233 K or less. Hence the term “definite ice clouds.” A  $\beta_{\text{mtropo}}(7.4/11\mu\text{m})$  threshold of 0.9 is used to distinguish single layer ice clouds from multilayered ice clouds (multilayered ice clouds have a  $0.0 < \beta_{\text{mtropo}}(7.4/11\mu\text{m}) < 0.9$ ). Some of the overlap between single layer and multilayered ice clouds shown in Figure 8 is due to errors in the CALIOP vertical feature mask. Further, the saturation optical depth (e.g. optical depth at which transmission approaches zero) of the CALIOP is also slightly smaller than the penetration depth of infrared radiation, which causes additional overlap between the distributions.

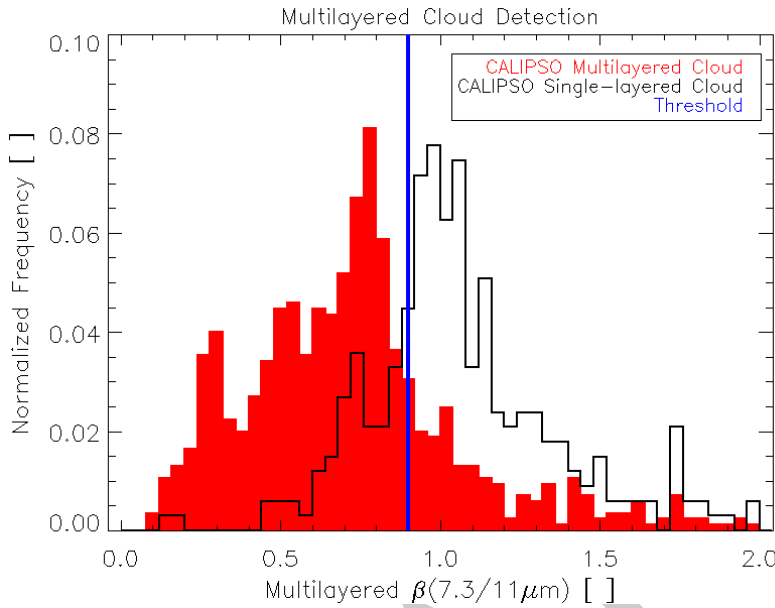

**Figure 8:** The normalized distribution of  $\beta_{\text{mtropo}}(7.4/11\mu\text{m})$  is shown for single layer (black) and multilayered (red) definite ice clouds. CALIOP was used to identify single layer clouds with a cloud top temperature of 233 K or less and multilayered cloud systems where the cloud top temperature of the highest cloud layer is 233 K or less. The threshold used to distinguish between single and multilayered ice cloud systems is shown in blue.

Sensor	WVMD_Thresh1	WVMD_Thresh2	WVMD_Thresh3	WVMD_Thresh4	WVMD_Thresh5	WVMD_Thresh6	WVMD_Thresh7	WVMD_Thresh8	WVMD_Thresh9
Met-8 SEVIRI	0.02	0.10	0.90	0.00	0.60	1.19	2.30	0.40	1.10
Met-9 SEVIRI	0.02	0.10	0.90	0.00	0.60	1.19	2.30	0.40	1.10
Terra MODIS	0.02	0.10	0.90	0.00	0.60	1.19	2.30	0.40	0.95
Aqua MODIS	0.02	0.10	0.90	0.00	0.60	1.19	2.30	0.40	0.95
GOES-R ABI	0.02	0.10	0.90	0.00	0.60	1.19	2.30	0.40	1.10

**Table 8:** The thresholds used by the Water Vapor Multilayered Detection (WVMD) Test as a function of sensor.

### 3.4.2.6.6 Infrared Window Multilayered Detection (IWMD) Test

**Purpose:** Detect multilayered cloud systems, where the highest cloud layer is semi-transparent to infrared radiation.

**Inputs:**

- $\epsilon_{\text{mtropo}}(11\mu\text{m})$
- $\beta_{\text{stropo}}(12/11\mu\text{m})$
- $\beta_{\text{mtropo}}(12/11\mu\text{m})$
- $\beta_{\text{mopaque}}(12/11\mu\text{m})$
- $\beta_{\text{stropo}}(8.5/11\mu\text{m})$
- $\beta_{\text{mtropo}}(8.5/11\mu\text{m})$
- $\beta_{\text{mopaque}}(8.5/11\mu\text{m})$
- $\beta_{\text{sopaque}}(8.5/11\mu\text{m})$  at the pixel Local Radiative Center (LRC)  
[ $\beta_{\text{sopaque}}(8.5/11\mu\text{m})_{\text{LRC}}$ ]
- $\beta_{\text{mtropo}}(12/11\mu\text{m}) - \beta_{\text{stropo}}(12/11\mu\text{m})$  [ $\beta_{\text{diff}}(12/11\mu\text{m})$ ]

**Logic:****PART I (Only 2 different thresholds are used)**

**If** ( $(\beta_{\text{sopaque}}(8.5/11\mu\text{m})_{\text{LRC}} > \text{IWMD\_Thresh1 AND } \beta_{\text{sopaque}}(8.5/11\mu\text{m})_{\text{LRC}} < \text{IWMD\_Thresh2}) \text{ OR } (\beta_{\text{mopaque}}(8.5/11\mu\text{m}) > \text{IWMD\_Thresh1 AND } \beta_{\text{mopaque}}(8.5/11\mu\text{m}) < \text{IWMD\_Thresh2}) \text{ OR } (\beta_{\text{mtropo}}(8.5/11\mu\text{m}) > \text{IWMD\_Thresh1 AND } \beta_{\text{mtropo}}(8.5/11\mu\text{m}) < \text{IWMD\_Thresh2})$ )

Ice\_signature = TRUE (the highest cloud layer is likely composed of ice)

**Else**

Ice\_signature = FALSE

**PART II (depends on results of PART I)**

**If** ( $\beta_{\text{stropo}}(12/11\mu\text{m}) > \text{IWMD\_Thresh3 AND } \beta_{\text{stropo}}(12/11\mu\text{m}) < \text{IWMD\_Thresh4 AND } \epsilon_{\text{mtropo}}(11\mu\text{m}) > \text{IWMD\_Thresh5 AND } \epsilon_{\text{mtropo}}(11\mu\text{m}) < \text{IWMD\_Thresh6 AND } \beta_{\text{diff}}(12/11\mu\text{m}) > \text{IWMD\_Thresh7 AND } \beta_{\text{mopaque}}(12/11\mu\text{m}) > \text{IWMD\_Thresh8 AND } \beta_{\text{mopaque}}(12/11\mu\text{m}) < \text{IWMD\_Thresh9 AND } \text{Ice\_signature} = \text{TRUE}$ )

Output = TRUE (multilayered clouds are present)

**Else**

Output = FALSE

**Thresholds and rational:**

The IWMD test is designed to detect multilayered ice clouds that cannot be detected with the WVMD test due to low signal-to-noise in the 7.4  $\mu\text{m}$  channel. When optically thin ice clouds overlap an optically thick lower cloud layer composed of liquid water, the single layer cloud assumptions will often result in values of  $\beta_{\text{stropo}}(12/11\mu\text{m})$ ,  $\beta_{\text{stropo}}(8.5/11\mu\text{m})$ , and  $\beta_{\text{sopaque}}(8.5/11\mu\text{m})$  that are representative of the lower cloud layer. The multilayered assumption will result in values of  $\beta_{\text{mtropo}}(12/11\mu\text{m})$ ,  $\beta_{\text{mtropo}}(8.5/11\mu\text{m})$ , and  $\beta_{\text{mopaque}}(8.5/11\mu\text{m})$  that are representative of the optically thin ice cloud. In contrast, when a single layer cloud is present, both the single layer and multilayered assumptions will be representative of the phase of the single cloud layer. The thresholds for implementing this test can be found in Table 9. These thresholds were derived from a combination of CALIPSO and manual analysis.

Sensor	IWMD_Thresh1	IWMD_Thresh2	IWMD_Thresh3	IWMD_Thresh4	IWMD_Thresh5	IWMD_Thresh6	IWMD_Thresh7	IWMD_Thresh8	IWMD_Thresh9
Met-8 SEVIRI	0.40	1.10	0.85	0.98	0.00	0.20	0.03	1.19	2.30
Met-9 SEVIRI	0.40	1.10	0.85	0.98	0.00	0.20	0.03	1.19	2.30
Terra MODIS	0.40	0.95	0.85	0.98	0.00	0.20	0.03	1.19	2.30
Aqua MODIS	0.40	0.95	0.85	0.98	0.00	0.20	0.03	1.19	2.30
GOES-R ABI	0.40	1.10	0.85	0.98	0.00	0.20	0.03	1.19	2.30

**Table 9: The thresholds used by the Infrared Window Multilayered Detection (IWMD) Test as a function of sensor.**

**3.4.2.6.7 Overall Multilayered Cloud (OMC) Test**

**Purpose:** Combine the results from the Water Vapor Multilayered Detection (WVMD) Test and the Infrared Window Multilayered Detection (IWMD) Test to determine if a multilayered cloud system is present.

**Inputs:**

- WVMD Test Result
- IWMD Test Result

**Logic:**

If (WVMD Test = TRUE **OR** IWMD Test = TRUE)

Output = TRUE (multilayered clouds are present)

**Else**

Output = FALSE

**Thresholds and rational:**

The combination of the WVMD and IWMD tests produce a more accurate representation of ice topped multilayered cloud systems.

**3.4.2.6.8 Homogeneous Freezing (HF) Test**

**Purpose:** Identify clouds that, based on their 11- $\mu\text{m}$  opaque cloud temperature, very likely have glaciated tops.

**Inputs:**

- $T_{\text{opaque}}(11\mu\text{m})$

**Logic:**

If ( $T_{\text{opaque}}(11\mu\text{m}) > 170.0 \text{ K}$  AND  $T_{\text{opaque}}(11\mu\text{m}) \leq 238.0 \text{ K}$ )

Output = TRUE (an ice cloud was detected)

**Else**

Output = FALSE

**Thresholds and rational:**

Clouds are assumed to have a glaciated top if the 11- $\mu\text{m}$  brightness temperature is less than or equal to 233 K (-40°C). This is the typical temperature at which small liquid droplets will freeze spontaneously (Rogers and Yau, 1989). In addition, Korolev et al. (2003) found that for in-cloud temperatures in the 233 – 238 K range, ice is by far the dominant phase, so a threshold of 238 K is used.

**3.4.2.6.9  $\beta_{\text{sopaque}}(8.5/11\mu\text{m})$  and Water Vapor Ice Cloud (BOWVIC) Test**

**Purpose:** Utilize the cloud phase information offered by  $\beta(8.5/11\mu\text{m})$  (see Figure 3), with the “opaque cloud assumption” (see Section 3.4.2.1.3) to identify ice clouds of varying optical depth.

**Inputs:**

- $T_{\text{opaque}}(7.4\mu\text{m})$
- $T_{\text{opaque}}(7.4\mu\text{m})$  at the pixel Local Radiative Center (LRC) [ $T_{\text{opaque}}(7.4\mu\text{m})_{\text{LRC}}$ ]
- $\beta_{\text{sopaque}}(8.5/11\mu\text{m})$

- $\beta_{\text{sopaque}}(8.5/11\mu\text{m})$  at the pixel LRC [ $\beta_{\text{sopaque}}(8.5/11\mu\text{m})_{\text{LRC}}$ ]
- $\beta_{\text{stropo}}(12/11\mu\text{m})$

**Logic:**

It is important to note that the thresholds symbolized in the logic below are a function of  $T_{\text{opaque}}(7.4\mu\text{m})$  or  $T_{\text{opaque}}(7.4\mu\text{m})_{\text{LRC}}$ .

**If** ( $\beta_{\text{sopaque}}(8.5/11\mu\text{m}) > \text{BOWVIC\_Thresh1}(T_{\text{opaque}}(7.4\mu\text{m}))$ ) **AND**  
 $\beta_{\text{sopaque}}(8.5/11\mu\text{m}) < \text{BOWVIC\_Thresh2}(T_{\text{opaque}}(7.4\mu\text{m}))$  **AND**  
 $\beta_{\text{sopaque}}(8.5/11\mu\text{m})_{\text{LRC}} > \text{BOWVIC\_Thresh3}(T_{\text{opaque}}(7.4\mu\text{m})_{\text{LRC}})$  **AND**  
 $\beta_{\text{sopaque}}(8.5/11\mu\text{m})_{\text{LRC}} < \text{BOWVIC\_Thresh4}(T_{\text{opaque}}(7.4\mu\text{m})_{\text{LRC}})$  **AND**  
 $\beta_{\text{stropo}}(12/11\mu\text{m}) > \text{BOWVIC\_Thresh5}(T_{\text{opaque}}(7.4\mu\text{m}))$  **AND**  
 $\beta_{\text{stropo}}(12/11\mu\text{m}) < \text{BOWVIC\_Thresh6}(T_{\text{opaque}}(7.4\mu\text{m}))$ )

Output = TRUE (an ice cloud was detected)

**Else**

Output = FALSE

**Thresholds and rational:**

CALIOP vertical cloud boundaries co-located with SEVIRI measurements were used to show the relationship between  $\beta_{\text{sopaque}}(8.5/11\mu\text{m})$  (see Section 3.4.2.1.3), and cloud top temperature as a function of the 7.4  $\mu\text{m}$  opaque cloud temperature (see Section 3.4.2.2). In this analysis, CALIOP-derived cloud top temperatures ( $T_{\text{cld}}$ ) are divided into five bins or categories. They are:

1.  $T_{\text{cld}} > 273$  K (warm liquid water)
2.  $263$  K  $< T_{\text{cld}} < 273$  K (warm mid-level)
3.  $243$  K  $< T_{\text{cld}} < 263$  K (intermediate mid-level)
4.  $233$  K  $< T_{\text{cld}} < 243$  K (cold mid-level)
5.  $T_{\text{cld}} < 233$  K (ice)

The first and fifth bins, defined by the melting and homogeneous freezing points of water, provide fairly unambiguous information on cloud phase. The middle three bins do not provide unambiguous cloud phase information. In-situ observations of mid-level clouds in the mid-latitudes indicate that clouds located above the melting level (273 K) are often composed of both ice and liquid water (e.g. Korolev et al., 2003). Interestingly enough, these mixed phase clouds are almost always composed of liquid water at the cloud top, with most of the ice being found near the cloud base (Carey et al., 2008). Thus, cloud phase identification from satellite radiances is greatly influenced by the penetration depth of the radiation into the cloud, which is wavelength dependent (e.g. does the radiometer sense both the liquid water and ice?). The ABI cloud type/phase algorithm utilizes infrared radiation, which has a small penetration depth relative to near-infrared and visible radiation. In addition, the goal of the algorithm is to identify the



cloud **top** phase. Given the observational evidence and the small penetration depth of infrared radiation, most clouds that fall into the middle cloud-top temperature bins should be classified as supercooled liquid water or mixed phase, depending on the penetration depth. Further, Korolev et al. (2003) found that at temperatures below 238.0 K, the ice phase is dominant. As such, most clouds that fall into the cold mid-level category should be composed primarily of ice. These physical concepts were taken into account when choosing thresholds.

The cumulative distribution function (CDF) of  $\beta_{\text{sopaque}}(8.5/11\mu\text{m})$  for the 5 CALIOP-derived cloud top temperature bins is shown for 5 different bins of 7.4  $\mu\text{m}$  opaque cloud temperature in Figure 9. The 7.4  $\mu\text{m}$  opaque cloud temperature ( $T_{\text{opaque}}(7.4\mu\text{m})$ ) provides an additional piece of information. The smaller the 7.4  $\mu\text{m}$  opaque cloud temperature, the greater the likelihood of ice. As can be seen, clouds that fall into the warm liquid water category (warmer than melting point of water) can be differentiated from definite ice clouds (colder than homogeneous freezing point) with a high degree of skill. Clouds in the warm mid-level category also generally have very little overlap with definite ice clouds. In the two lowest (coldest)  $T_{\text{opaque}}(7.4\mu\text{m})$  bins (see Figure 9), the  $\beta_{\text{sopaque}}(8.5/11\mu\text{m})$  thresholds were chosen such that most of the observations would be classified as ice. This decision was largely based on the analysis of independent near-infrared reflectance data. For the final three  $T_{\text{opaque}}(7.4\mu\text{m})$  bins,  $\beta_{\text{sopaque}}(8.5/11\mu\text{m})$  thresholds were chosen such that intermediate mid-level clouds would be classified as ice about 50% of the time.

In order to make this test more robust, a few additional constraints are applied. As discussed earlier, the  $\beta_{\text{sopaque}}(8.5/11\mu\text{m})$  value near cloud edges may be suspect, so the  $\beta_{\text{sopaque}}(8.5/11\mu\text{m})$  value at the pixel Local Radiative Center (LRC) is also checked for conformance to the  $\beta_{\text{sopaque}}(8.5/11\mu\text{m})$  threshold values. In addition, a gross check on the  $\beta_{\text{stropo}}(12/11\mu\text{m})$  value is performed when the 7.4  $\mu\text{m}$  opaque cloud temperature is undefined, like in Panel E of Figure 9. All of the thresholds used in this test can be found in Table 10 through Table 15. Given that the  $\beta_{\text{sopaque}}(8.5/11\mu\text{m})$  threshold is dependent on sensor and  $T_{\text{opaque}}(7.4\mu\text{m})$ , each threshold “function” is stored in it’s own table.

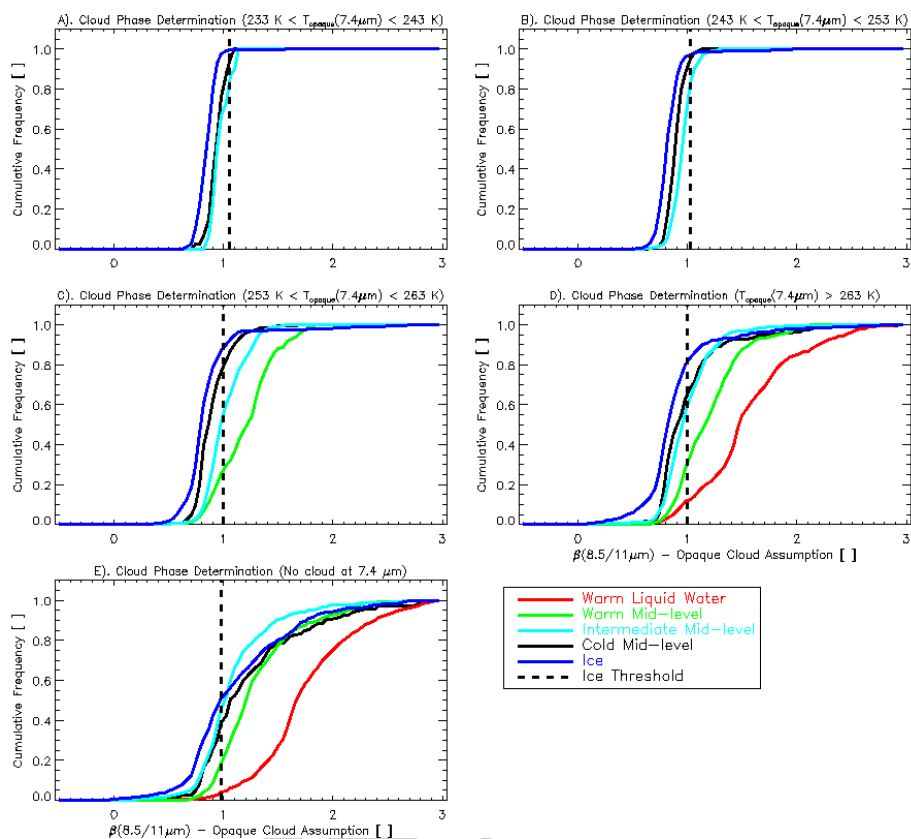

**Figure 9:** The cumulative distribution function (CDF) of  $\beta_{\text{opaque}}(8.5/11\mu\text{m})$  for 5 CALIOP-derived cloud top temperature bins is shown for 5 different bins of  $7.4\mu\text{m}$  opaque cloud temperature ( $T_{\text{opaque}}(7.4\mu\text{m})$ ). In panel A,  $233\text{ K} < T_{\text{opaque}}(7.4\mu\text{m}) < 243\text{ K}$ . In panel B,  $243\text{ K} < T_{\text{opaque}}(7.4\mu\text{m}) < 253\text{ K}$ . In panel C,  $253\text{ K} < T_{\text{opaque}}(7.4\mu\text{m}) < 263\text{ K}$ . In panel D,  $T_{\text{opaque}}(7.4\mu\text{m}) > 263\text{ K}$ . Finally in panel E,  $T_{\text{opaque}}(7.4\mu\text{m})$  is undefined because the cloud is well below the peak of the  $7.4\mu\text{m}$  weighting function or the cloud is too optically thin to be differentiated from the  $7.4\mu\text{m}$  clear sky signal.

Sensor	$T_{\text{opaque}}(7.4\mu\text{m})$ is invalid	$180\text{ K} \leq T_{\text{opaque}}(7.4\mu\text{m}) < 233\text{ K}$	$233\text{ K} \leq T_{\text{opaque}}(7.4\mu\text{m}) < 243\text{ K}$	$243\text{ K} \leq T_{\text{opaque}}(7.4\mu\text{m}) < 253\text{ K}$	$253\text{ K} \leq T_{\text{opaque}}(7.4\mu\text{m}) < 263\text{ K}$	$T_{\text{opaque}}(7.4\mu\text{m}) \geq 263\text{ K}$
Met-8 SEVIRI	0.10	0.10	0.10	0.10	0.10	0.10
Met-9 SEVIRI	0.10	0.10	0.10	0.10	0.10	0.10
Terra MODIS	0.10	0.10	0.10	0.10	0.10	0.10
Aqua MODIS	0.10	0.10	0.10	0.10	0.10	0.10

GOES-R ABI	0.10	0.10	0.10	0.10	0.10	0.10
------------	------	------	------	------	------	------

**Table 10: “BOWVIC\_Thresh1” threshold values used in the  $\beta_{\text{sopaque}}(8.5/11\mu\text{m})$  and Water Vapor Ice Cloud (BOWVIC) Test as a function of sensor and 7.4  $\mu\text{m}$  opaque cloud temperature ( $T_{\text{opaque}}(7.4\mu\text{m})$ ).**

Sensor	$T_{\text{opaque}}(7.4\mu\text{m})$ is invalid	180 K $\leq$ $T_{\text{opaque}}(7.4\mu\text{m})$ < 233 K	233 K $\leq$ $T_{\text{opaque}}(7.4\mu\text{m})$ < 243 K	243 K $\leq$ $T_{\text{opaque}}(7.4\mu\text{m})$ < 253 K	253 K $\leq$ $T_{\text{opaque}}(7.4\mu\text{m})$ < 263 K	$T_{\text{opaque}}(7.4\mu\text{m})$ $\geq$ 263 K
Met-8 SEVIRI	0.98	1.10	1.05	1.02	1.00	1.00
Met-9 SEVIRI	0.98	1.10	1.05	1.02	1.00	1.00
<i>Terra</i> MODIS	0.75	1.10	1.05	0.87	0.85	0.80
<i>Aqua</i> MODIS	0.75	1.10	1.05	0.87	0.85	0.80
GOES-R ABI	0.98	1.10	1.05	1.02	1.00	1.00

**Table 11: “BOWVIC\_Thresh2” threshold values used in the  $\beta_{\text{sopaque}}(8.5/11\mu\text{m})$  and Water Vapor Ice Cloud (BOWVIC) Test as a function of sensor and 7.4  $\mu\text{m}$  opaque cloud temperature ( $T_{\text{opaque}}(7.4\mu\text{m})$ ).**

Sensor	$T_{\text{opaque}}(7.4\mu\text{m})$ is invalid	180 K $\leq$ $T_{\text{opaque}}(7.4\mu\text{m})$ < 233 K	233 K $\leq$ $T_{\text{opaque}}(7.4\mu\text{m})$ < 243 K	243 K $\leq$ $T_{\text{opaque}}(7.4\mu\text{m})$ < 253 K	253 K $\leq$ $T_{\text{opaque}}(7.4\mu\text{m})$ < 263 K	$T_{\text{opaque}}(7.4\mu\text{m})$ $\geq$ 263 K
Met-8 SEVIRI	0.10	-10000.0	-10000.0	-10000.0	0.10	0.10
Met-9 SEVIRI	0.10	-10000.0	-10000.0	-10000.0	0.10	0.10
<i>Terra</i> MODIS	0.10	-10000.0	-10000.0	-10000.0	0.10	0.10
<i>Aqua</i> MODIS	0.10	-10000.0	-10000.0	-10000.0	0.10	0.10
GOES-R ABI	0.10	-10000.0	-10000.0	-10000.0	0.10	0.10

**Table 12: “BOWVIC\_Thresh3” threshold values used in the  $\beta_{\text{sopaque}}(8.5/11\mu\text{m})$  and Water Vapor Ice Cloud (BOWVIC) Test as a function of sensor and 7.4  $\mu\text{m}$  opaque cloud temperature ( $T_{\text{opaque}}(7.4\mu\text{m})$ ).**

Sensor	$T_{\text{opaque}}(7.4\mu\text{m})$ is invalid	180 K $\leq$ $T_{\text{opaque}}(7.4\mu\text{m})$ < 233 K	233 K $\leq$ $T_{\text{opaque}}(7.4\mu\text{m})$ < 243 K	243 K $\leq$ $T_{\text{opaque}}(7.4\mu\text{m})$ < 253 K	253 K $\leq$ $T_{\text{opaque}}(7.4\mu\text{m})$ < 263 K	$T_{\text{opaque}}(7.4\mu\text{m})$ $\geq$ 263 K
Met-8 SEVIRI	0.98	10000.0	10000.0	10000.0	1.00	1.00
Met-9 SEVIRI	0.98	10000.0	10000.0	10000.0	1.00	1.00
<i>Terra</i>	0.75	10000.0	10000.0	10000.0	0.85	0.80

MODIS						
<i>Aqua</i> MODIS	0.75	10000.0	10000.0	10000.0	0.85	0.80
GOES- R ABI	0.98	10000.0	10000.0	10000.0	1.00	1.00

**Table 13: “BOWVIC\_Thresh4” threshold values used in the  $\beta_{\text{sopaque}}(8.5/11\mu\text{m})$  and Water Vapor Ice Cloud (BOWVIC) Test as a function of sensor and  $7.4\mu\text{m}$  opaque cloud temperature ( $T_{\text{opaque}}(7.4\mu\text{m})$ ).**

Sensor	$T_{\text{opaque}}(7.4\mu\text{m})$ is invalid	$180\text{ K} \leq T_{\text{opaque}}(7.4\mu\text{m}) < 233\text{ K}$	$233\text{ K} \leq T_{\text{opaque}}(7.4\mu\text{m}) < 243\text{ K}$	$243\text{ K} \leq T_{\text{opaque}}(7.4\mu\text{m}) < 253\text{ K}$	$253\text{ K} \leq T_{\text{opaque}}(7.4\mu\text{m}) < 263\text{ K}$	$T_{\text{opaque}}(7.4\mu\text{m}) \geq 263\text{ K}$
Met-8 SEVIRI	0.99	-10000.0	-10000.0	-10000.0	-10000.0	-10000.0
Met-9 SEVIRI	0.99	-10000.0	-10000.0	-10000.0	-10000.0	-10000.0
<i>Terra</i> MODIS	0.95	-10000.0	-10000.0	-10000.0	-10000.0	-10000.0
<i>Aqua</i> MODIS	0.95	-10000.0	-10000.0	-10000.0	-10000.0	-10000.0
GOES- R ABI	0.99	-10000.0	-10000.0	-10000.0	-10000.0	-10000.0

**Table 14: “BOWVIC\_Thresh5” threshold values used in the  $\beta_{\text{sopaque}}(8.5/11\mu\text{m})$  and Water Vapor Ice Cloud (BOWVIC) Test as a function of sensor and  $7.4\mu\text{m}$  opaque cloud temperature ( $T_{\text{opaque}}(7.4\mu\text{m})$ ).**

Sensor	$T_{\text{opaque}}(7.4\mu\text{m})$ is invalid	$180\text{ K} \leq T_{\text{opaque}}(7.4\mu\text{m}) < 233\text{ K}$	$233\text{ K} \leq T_{\text{opaque}}(7.4\mu\text{m}) < 243\text{ K}$	$243\text{ K} \leq T_{\text{opaque}}(7.4\mu\text{m}) < 253\text{ K}$	$253\text{ K} \leq T_{\text{opaque}}(7.4\mu\text{m}) < 263\text{ K}$	$T_{\text{opaque}}(7.4\mu\text{m}) \geq 263\text{ K}$
Met-8 SEVIRI	0.99	10000.0	10000.0	10000.0	10000.0	10000.0
Met-9 SEVIRI	0.99	10000.0	10000.0	10000.0	10000.0	10000.0
<i>Terra</i> MODIS	0.95	10000.0	10000.0	10000.0	10000.0	10000.0
<i>Aqua</i> MODIS	0.95	10000.0	10000.0	10000.0	10000.0	10000.0
GOES- R ABI	0.99	10000.0	10000.0	10000.0	10000.0	10000.0

**Table 15: “BOWVIC\_Thresh6” threshold values used in the  $\beta_{\text{sopaque}}(8.5/11\mu\text{m})$  and Water Vapor Ice Cloud (BOWVIC) Test as a function of sensor and  $7.4\mu\text{m}$  opaque cloud temperature ( $T_{\text{opaque}}(7.4\mu\text{m})$ ).**

**3.4.2.6.10  $\beta_{\text{sopaque}}(8.5/11\mu\text{m})$  and Water Vapor Ice Cloud LRC-only (BOWVIC-LRC) Test**

**Purpose:** Utilize the cloud phase information offered by  $\beta(8.5/11\mu\text{m})$  (see Figure 3), with the “opaque cloud assumption” (see Section 3.4.2.1.3), and the Local Radiative Center (LRC) concept to identify optically thin ice clouds.

**Inputs:**

- $T_{\text{opaque}}(7.4\mu\text{m})$  at the pixel Local Radiative Center (LRC) [ $T_{\text{opaque}}(7.4\mu\text{m})_{\text{LRC}}$ ]
- $\beta_{\text{sopaque}}(8.5/11\mu\text{m})$  at the pixel LRC [ $\beta_{\text{sopaque}}(8.5/11\mu\text{m})_{\text{LRC}}$ ]
- $\beta_{\text{stropo}}(12/11\mu\text{m})$

**Logic:**

It is important to note that the first two thresholds symbolized in the logic below are a function of  $T_{\text{opaque}}(7.4\mu\text{m})_{\text{LRC}}$ .

**If**  $\beta_{\text{sopaque}}(8.5/11\mu\text{m})_{\text{LRC}} > \text{BOWVIC\_Thresh1}(T_{\text{opaque}}(7.4\mu\text{m})_{\text{LRC}})$  **AND**  
 $\beta_{\text{sopaque}}(8.5/11\mu\text{m})_{\text{LRC}} < \text{BOWVIC\_Thresh2}(T_{\text{opaque}}(7.4\mu\text{m})_{\text{LRC}})$  **AND**  
 $\beta_{\text{stropo}}(12/11\mu\text{m}) > \text{BOWVIC-LRC\_Thresh3}$  **AND**  
 $\beta_{\text{stropo}}(12/11\mu\text{m}) < \text{BOWVIC-LRC\_Thresh4}$

Output = TRUE (an ice cloud was detected)

**Else**

Output = FALSE

**Thresholds and rational:**

This test is a slight variant on the  $\beta_{\text{sopaque}}(8.5/11\mu\text{m})$  and Water Vapor Ice Cloud (BOWVIC) Test (see Section 3.4.2.6.9). In this version of the test, only the value of  $\beta_{\text{sopaque}}(8.5/11\mu\text{m})$  at the pixel Local Radiative Center (LRC) is examined, and different  $\beta_{\text{stropo}}(12/11\mu\text{m})$  thresholds are applied. The  $\beta_{\text{sopaque}}(8.5/11\mu\text{m})$  thresholds can be found in Table 10 and Table 11. The  $\beta_{\text{stropo}}(12/11\mu\text{m})$  thresholds can be found in Table 16. This test is motivated by the desire to detect as many thin cirrus clouds as possible.

Sensor	BOWVIC-LRC Thresh3	BOWVIC-LRC Thresh4
Met-8 SEVIRI	0.95	1.50
Met-9 SEVIRI	0.95	1.50
Terra-MODIS	0.92	1.45
Aqua-MODIS	0.92	1.45
GOES-R ABI	0.95	1.50

**Table 16: The third and fourth thresholds used by the  $\beta_{\text{sopaque}}(8.5/11\mu\text{m})$  and Water Vapor Ice Cloud LRC-only (BOWVIC-LRC) Test as a function of sensor.**

**3.4.2.6.11  $\beta_{\text{sopaque}}(8.5/11\mu\text{m})$  Opaque Ice Cloud (BOIC) Test**

**Purpose:** Utilize the cloud phase information offered by  $\beta(8.5/11\mu\text{m})$  (see Figure 3), with the “opaque cloud assumption” (see Section 3.4.2.1.3) to identify opaque mid-level glaciated clouds.

**Inputs:**

- Results from the OCTD Test (see Section 3.4.2.6.3)
- $T_{\text{opaque}}(11\mu\text{m})$
- $\beta_{\text{opaque}}(8.5/11\mu\text{m})$
- $\beta_{\text{opaque}}(8.5/11\mu\text{m})$  at the pixel Local Radiative Center (LRC)  
[ $\beta_{\text{opaque}}(8.5/11\mu\text{m})_{\text{LRC}}$ ]

**Logic:**

**If** (OCTD Test = TRUE AND

$T_{\text{opaque}}(11\mu\text{m}) < 273.16 \text{ K}$  AND  
 $\beta_{\text{opaque}}(8.5/11\mu\text{m}) > \text{BOIC\_Thresh1}$  AND  
 $\beta_{\text{opaque}}(8.5/11\mu\text{m}) < \text{BOIC\_Thresh2}$  AND  
 $\beta_{\text{opaque}}(8.5/11\mu\text{m})_{\text{LRC}} > \text{BOIC\_Thresh3}$  AND  
 $\beta_{\text{opaque}}(8.5/11\mu\text{m})_{\text{LRC}} < \text{BOIC\_Thresh4}$ )

Output = TRUE (an ice cloud was detected)

**Else**

Output = FALSE

**Thresholds and rational:**

This test is a simple complement to the  $\beta_{\text{sopaque}}(8.5/11\mu\text{m})$  and Water Vapor Ice Cloud (BOWVIC) Test designed to make sure that opaque mid-level glaciated clouds do not get missed. Since this test is designed to detect mid-level opaque glaciated clouds, the  $11 \mu\text{m}$  opaque cloud temperature must be less than the melting point of water (273.16 K). The  $\beta_{\text{sopaque}}(8.5/11\mu\text{m})$  thresholds were chosen based on the manual analysis of independent near-infrared reflectance data. The thresholds are listed in Table 17.

Sensor	BOIC Thresh1	BOIC Thresh2	BOIC Thresh3	BOIC Thresh4
Met-8 SEVIRI	0.40	1.10	0.40	1.12
Met-9 SEVIRI	0.40	1.10	0.40	1.12
<i>Terra</i> MODIS	0.40	0.95	0.40	0.97
<i>Aqua</i> MODIS	0.40	0.95	0.40	0.97
GOES-R ABI	0.40	1.10	0.40	1.12

**Table 17: The thresholds used by the  $\beta_{\text{sopaque}}(8.5/11\mu\text{m})$  Opaque Ice Cloud (BOIC) Test as a function of sensor.**

### 3.4.2.6.12 $\beta_{stropo}(8.5/11\mu m)$ and Water Vapor Ice Cloud (BTWVIC) Test

**Purpose:** Utilize the cloud phase information offered by  $\beta(8.5/11\mu m)$  (see Figure 3), with the “top of troposphere assumption” (see Section 3.4.2.1.1), to identify optically thin ice clouds over low emissivity surfaces.

**Inputs:**

- Result of Low Surface Emissivity (LSE) Test
- $T_{opaque}(7.4\mu m)$
- $\beta_{stropo}(8.5/11\mu m)$
- $\beta_{sopaque}(12/11\mu m)$

**Logic:**

It is important to note that the first two thresholds symbolized in the logic below are a function of  $T_{opaque}(7.4\mu m)$ .

**If** (LSE Test = TRUE AND  
 $\beta_{stropo}(8.5/11\mu m) > BTWVIC\_Thresh1(T_{opaque}(7.4\mu m))$  AND  
 $\beta_{stropo}(8.5/11\mu m) < BTWVIC\_Thresh2(T_{opaque}(7.4\mu m))$  AND  
 $\beta_{sopaque}(12/11\mu m) > BTWVIC\_Thresh3$  AND  
 $\beta_{sopaque}(12/11\mu m) < BTWVIC\_Thresh4$ )

Output = TRUE (an ice cloud was detected)

**Else**

Output = FALSE

**Thresholds and rational:**

Comparisons to CALIOP have shown that  $\beta_{sopaque}(8.5/11\mu m)$  is a more robust cloud phase metric than  $\beta_{stropo}(8.5/11\mu m)$ , except over low emissivity surfaces. That is why this test is only applied over low emissivity surfaces. Over very low emissivity surfaces, the effective cloud level needs to be reasonably accurate; otherwise the cloud microphysical information offered by  $\beta(8.5/11\mu m)$  will be minimal (Pavolonis, 2010a). For optically thin ice clouds in the upper troposphere, the “opaque cloud assumption” generally results in an effective cloud level that is much lower than the actual cloud level. In order to accurately identify thin cirrus clouds over low emissivity surfaces like the Sahara Desert, the “top of troposphere assumption” is needed. Table 18 through Table 20 list the thresholds required by this test. The thresholds were determined through analysis of CALIOP data and manual analysis of multi-spectral imagery. The cumulative distribution function (CDF) of  $\beta_{stropo}(8.5/11\mu m)$  for the 5 CALIOP-derived cloud top temperature bins is shown for 3 different bins of 7.4  $\mu m$  opaque cloud temperature in Figure 10. Figure 10 is analogous to Figure 9. As Figure 10 shows, very conservative  $\beta_{stropo}(8.5/11\mu m)$  thresholds were chosen to prevent false ice cloud detects. In addition,

we found that the value  $\beta_{\text{stropo}}(8.5/11\mu\text{m})$  tend to be lower over low emissivity surfaces, which influenced our choice of threshold values.

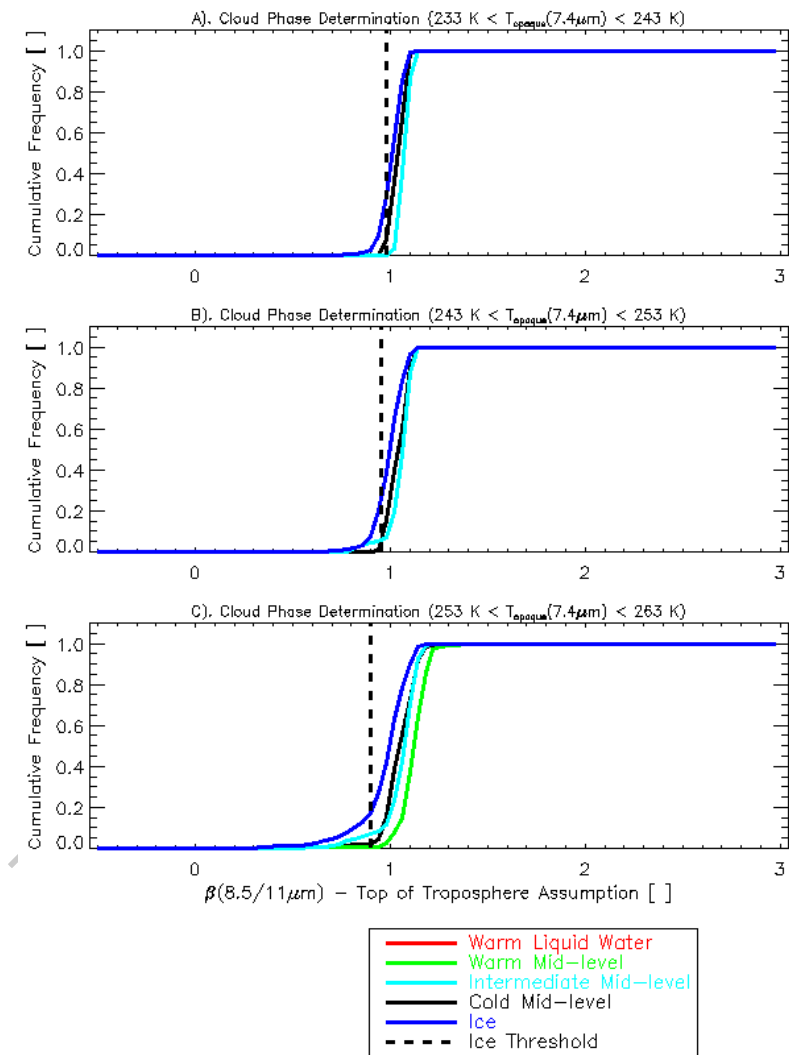

**Figure 10:** The cumulative distribution function (CDF) of  $\beta_{\text{stropo}}(8.5/11\mu\text{m})$  for 5 CALIOP-derived cloud top temperature bins is shown for 3 different bins of  $7.4 \mu\text{m}$  opaque cloud temperature ( $T_{\text{opaque}}(7.4\mu\text{m})$ ). In panel A,  $233 \text{ K} < T_{\text{opaque}}(7.4\mu\text{m}) <$



243 K. In panel B,  $243 \text{ K} < T_{\text{opaque}}(7.4\mu\text{m}) < 253 \text{ K}$ . In panel C,  $253 \text{ K} < T_{\text{opaque}}(7.4\mu\text{m}) < 263 \text{ K}$ .

Sensor	$T_{\text{opaque}}(7.4\mu\text{m})$ is $< 233 \text{ K}$ or is invalid	$233 \text{ K} \leq$ $T_{\text{opaque}}(7.4\mu\text{m})$ $< 243 \text{ K}$	$243 \text{ K} \leq$ $T_{\text{opaque}}(7.4\mu\text{m})$ $< 253 \text{ K}$	$253 \text{ K} \leq$ $T_{\text{opaque}}(7.4\mu\text{m})$ $< 263 \text{ K}$	$T_{\text{opaque}}(7.4\mu\text{m})$ $\geq 263 \text{ K}$
Met-8 SEVIRI	10000.0	0.40	0.40	0.40	10000.0
Met-9 SEVIRI	10000.0	0.40	0.40	0.40	10000.0
<i>Terra</i> MODIS	10000.0	0.40	0.40	0.40	10000.0
<i>Aqua</i> MODIS	10000.0	0.40	0.40	0.40	10000.0
GOES- R ABI	10000.0	0.40	0.40	0.40	10000.0

**Table 18: “BTWVIC\_Thresh1” threshold values used in the  $\beta_{\text{stropo}}(8.5/11\mu\text{m})$  and Water Vapor Ice Cloud (BTWVIC) Test as a function of sensor and  $7.4 \mu\text{m}$  opaque cloud temperature ( $T_{\text{opaque}}(7.4\mu\text{m})$ ).**

Sensor	$T_{\text{opaque}}(7.4\mu\text{m})$ is $< 233 \text{ K}$ or is invalid	$233 \text{ K} \leq$ $T_{\text{opaque}}(7.4\mu\text{m})$ $< 243 \text{ K}$	$243 \text{ K} \leq$ $T_{\text{opaque}}(7.4\mu\text{m})$ $< 253 \text{ K}$	$253 \text{ K} \leq$ $T_{\text{opaque}}(7.4\mu\text{m})$ $< 263 \text{ K}$	$T_{\text{opaque}}(7.4\mu\text{m})$ $\geq 263 \text{ K}$
Met-8 SEVIRI	-10000.0	0.98	0.95	0.90	-10000.0
Met-9 SEVIRI	-10000.0	0.98	0.95	0.90	-10000.0
<i>Terra</i> MODIS	-10000.0	0.93	0.90	0.85	-10000.0
<i>Aqua</i> MODIS	-10000.0	0.93	0.90	0.85	-10000.0
GOES- R ABI	-10000.0	0.98	0.95	0.90	-10000.0

**Table 19: “BTWVIC\_Thresh2” threshold values used in the  $\beta_{\text{stropo}}(8.5/11\mu\text{m})$  and Water Vapor Ice Cloud (BTWVIC) Test as a function of sensor and  $7.4 \mu\text{m}$  opaque cloud temperature ( $T_{\text{opaque}}(7.4\mu\text{m})$ ).**

Sensor	BTWVIC Thresh3	BTWVIC Thresh4
Met-8 SEVIRI	1.00	2.00
Met-9 SEVIRI	1.00	2.00
<i>Terra</i> MODIS	0.98	2.00
<i>Aqua</i> MODIS	0.98	2.00
GOES-R ABI	1.00	2.00

**Table 20: The “BTWVIC\_Thresh3” and ” BTWVIC\_Thresh4” thresholds used by the  $\beta_{\text{stropo}}(8.5/11\mu\text{m})$  Water Vapor Ice Cloud (BTWVIC) Test as a function of sensor.**

#### **3.4.2.6.13 Overall Ice Cloud (OIC) Test**

**Purpose:** To combine the results from the Homogeneous Freezing (HF),  $\beta_{\text{sopaque}}(8.5/11\mu\text{m})$  and Water Vapor Ice Cloud (BOWVIC),  $\beta_{\text{sopaque}}(8.5/11\mu\text{m})$  and Water Vapor Ice Cloud LRC-only (BOWVIC-LRC),  $\beta_{\text{sopaque}}(8.5/11\mu\text{m})$  Opaque Ice Cloud (BOIC), and  $\beta_{\text{stropo}}(8.5/11\mu\text{m})$  and Water Vapor Ice Cloud (BTWVIC) Tests to determine if an ice phase or glaciated cloud is present.

**Input:**

- HF Test Results (see Section 3.4.2.6.8)
- BOWVIC Test Results (see Section 3.4.2.6.9)
- BOWVIC-LRC Test Results (see Section 3.4.2.6.10)
- BOIC Test Results (see Section 3.4.2.6.11)
- BTWVIC Test Results (see Section 3.4.2.6.12)

**Logic:**

**If** (HF Test = TRUE **OR**  
BOWVIC Test = TRUE **OR**  
BOWVIC-LRC = TRUE **OR**  
BOIC = TRUE **OR**  
BTWVIC = TRUE)

Output = TRUE (an ice cloud was detected)

**Else**

Output = FALSE

**Thresholds and rational:**

If any if the previous ice cloud tests were positive (TRUE), then an ice cloud is assumed to be present.

#### **3.4.2.6.14 Sub-classify Ice Cloud (SCIC) Test**

**Purpose:** Given an ice cloud, determine if it belongs in the semi-transparent cloud type category or the opaque cloud category.

**Input:**

- Results of Overall Opaque Cloud (OOC) Test (see Section 3.4.2.6.4)
- $\epsilon_{\text{stropo}}(11\mu\text{m})$

**Logic:**

**If** ( $\epsilon_{\text{stropo}}(11\mu\text{m}) < \text{SCIC\_Thresh1}$  **OR**  
(OOC Test = TRUE **AND**  $\epsilon_{\text{stropo}}(11\mu\text{m}) < \text{SCIC\_Thresh2}$ )

Output = TRUE (the cloud is semi-transparent)

**Else**

Output = FALSE

**Thresholds and rational:**

This test simply utilizes previously established information on whether or not an ice cloud has an 11- $\mu\text{m}$  optical depth of approximately 2.0 or less. Loose  $\epsilon_{\text{stropo}}(11\mu\text{m})$  thresholds are also included to decrease the odds of misclassification. The  $\epsilon_{\text{stropo}}(11\mu\text{m})$  thresholds can be found in Table 21.

Sensor	SCIC_Thresh1	SCIC_Thresh2
Met-8 SEVIRI	0.40	0.85
Met-9 SEVIRI	0.40	0.85
Terra-MODIS	0.40	0.85
Aqua-MODIS	0.40	0.85
GOES-R ABI	0.40	0.85

**Table 21: The thresholds used by the Sub-classify Ice Cloud (SCIC) Test as a function of sensor.**

### 3.4.2.6.15 Mixed Phase (MP) Test

**Purpose:** Utilize the cloud phase information offered by  $\beta(8.5/11\mu\text{m})$  (see Figure 3), with the “opaque cloud assumption” (see Section 3.4.2.1.3) to identify optically thick clouds that are potentially mixed phase near cloud top.

**Inputs:**

- $T_{\text{opaque}}(11\mu\text{m})$
- $T_{\text{opaque}}(11\mu\text{m})$  at the pixel Local Radiative Center (LRC) [ $T_{\text{opaque}}(11\mu\text{m})_{\text{LRC}}$ ]
- $\beta_{\text{sopaque}}(8.5/11\mu\text{m})$
- $\beta_{\text{sopaque}}(8.5/11\mu\text{m})$  at the pixel LRC [ $\beta_{\text{sopaque}}(8.5/11\mu\text{m})_{\text{LRC}}$ ]

**Logic:**

It is important to note that the thresholds symbolized in the logic below are a function of  $T_{\text{opaque}(11\mu\text{m})}$  or  $T_{\text{opaque}(11\mu\text{m})\_LRC}$ .

**If** ( $\beta_{\text{sopaque}(8.5/11\mu\text{m})} > \text{MP\_Thresh1}(T_{\text{opaque}(11\mu\text{m})})$ ) **AND**  
 $\beta_{\text{sopaque}(8.5/11\mu\text{m})} < \text{MP\_Thresh2}(T_{\text{opaque}(11\mu\text{m})})$  **AND**  
 $\beta_{\text{sopaque}(8.5/11\mu\text{m})\_LRC} > \text{MP\_Thresh3}(T_{\text{opaque}(11\mu\text{m})\_LRC})$  **AND**  
 $\beta_{\text{sopaque}(8.5/11\mu\text{m})\_LRC} < \text{MP\_Thresh4}(T_{\text{opaque}(11\mu\text{m})\_LRC})$

Output = TRUE (the cloud is potentially mixed phase)

**Else**

Output = FALSE

**Thresholds and rational:**

Other than a small number of aircraft data sets, very few of which can be co-located with proxy GOES-R ABI data, unambiguous information on the phase of hydrometeors that are colder than the melting point of water or warmer than the homogeneous freezing temperature of water is unavailable. As such,  $\beta_{\text{sopaque}(8.5/11\mu\text{m})}$  CDF's, like those constructed to determine the thresholds used in the  $\beta_{\text{sopaque}(8.5/11\mu\text{m})}$  and Water Vapor Ice Cloud (BOWVIC) Test (see Section 3.4.2.6.9), were used to develop thresholds to identify mixed phase clouds. Since mixed phase clouds may be present at altitudes that are below the  $7.4\mu\text{m}$  weighting function, the  $\beta_{\text{sopaque}(8.5/11\mu\text{m})}$  thresholds are expressed as a function of the  $11\mu\text{m}$  opaque cloud temperature instead of the  $7.4\mu\text{m}$  opaque cloud temperature. The CDF of  $\beta_{\text{sopaque}(8.5/11\mu\text{m})}$  for the 5 CALIOP-derived cloud top temperature bins is shown for 4 different bins of  $11\mu\text{m}$  opaque cloud temperature ( $T_{\text{opaque}(11\mu\text{m})}$ ) in Figure 11. The thresholds were chosen such that about 50% of the warm mid-level clouds in the  $263\text{ K} < T_{\text{opaque}(11\mu\text{m})} < 273\text{ K}$  bin are classified as mixed phase (see Figure 11, Panel D) and the  $\beta_{\text{sopaque}(8.5/11\mu\text{m})}$  threshold is increased by 0.05 increments moving to lower  $T_{\text{opaque}(11\mu\text{m})}$  bins. This choice is primarily based on limited aircraft measurements (Cober et al., 2001). The actual threshold values are listed in Table 22 – Table 25.

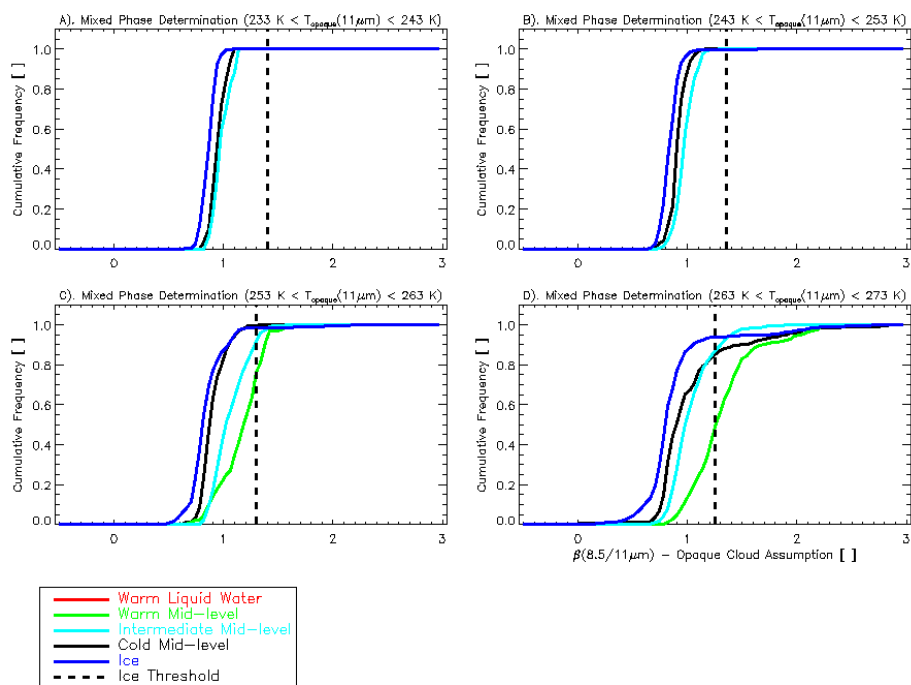

**Figure 11: The cumulative distribution function (CDF) of  $\beta_{\text{sopaque}}(8.5/11\mu\text{m})$  for 5 CALIOP-derived cloud top temperature bins is shown for 4 different bins of  $11\mu\text{m}$  opaque cloud temperature ( $T_{\text{opaque}}(11\mu\text{m})$ ). In panel A,  $233\text{ K} < T_{\text{opaque}}(11\mu\text{m}) < 243\text{ K}$ . In panel B,  $243\text{ K} < T_{\text{opaque}}(11\mu\text{m}) < 253\text{ K}$ . In panel C,  $253\text{ K} < T_{\text{opaque}}(11\mu\text{m}) < 263\text{ K}$ . In panel D,  $263\text{ K} < T_{\text{opaque}}(11\mu\text{m}) < 273\text{ K}$ .**

Sensor	$233\text{ K} \leq T_{\text{opaque}}(11\mu\text{m}) < 243\text{ K}$	$243\text{ K} \leq T_{\text{opaque}}(11\mu\text{m}) < 253\text{ K}$	$253\text{ K} \leq T_{\text{opaque}}(11\mu\text{m}) < 263\text{ K}$	$263\text{ K} \leq T_{\text{opaque}}(11\mu\text{m}) < 273\text{ K}$
Met-8 SEVIRI	0.40	0.40	0.40	0.40
Met-9 SEVIRI	0.40	0.40	0.40	0.40
<i>Terra</i> MODIS	0.40	0.40	0.40	0.40
<i>Aqua</i> MODIS	0.40	0.40	0.40	0.40
GOES-R ABI	0.40	0.40	0.40	0.40

**Table 22: “MP\_Thresh1” threshold values used in the Mixed Phase (MP) Test as a function of sensor and 11  $\mu\text{m}$  opaque cloud temperature ( $T_{\text{opaque}}(11\mu\text{m})$ ).**

Sensor	233 K $\leq$ $T_{\text{opaque}}(11\mu\text{m}) < 243$ K	243 K $\leq$ $T_{\text{opaque}}(11\mu\text{m}) < 253$ K	253 K $\leq$ $T_{\text{opaque}}(11\mu\text{m}) < 263$ K	263 K $\leq$ $T_{\text{opaque}}(11\mu\text{m}) < 273$ K
Met-8 SEVIRI	1.40	1.35	1.30	1.25
Met-9 SEVIRI	1.40	1.35	1.30	1.25
<i>Terra</i> MODIS	1.25	1.20	1.15	1.10
<i>Aqua</i> MODIS	1.25	1.20	1.15	1.10
GOES-R ABI	1.40	1.35	1.30	1.25

**Table 23: “MP\_Thresh2” threshold values used in the Mixed Phase (MP) Test as a function of sensor and 11  $\mu\text{m}$  opaque cloud temperature ( $T_{\text{opaque}}(11\mu\text{m})$ ).**

Sensor	233 K $\leq$ $T_{\text{opaque}}(11\mu\text{m}) < 243$ K	243 K $\leq$ $T_{\text{opaque}}(11\mu\text{m}) < 253$ K	253 K $\leq$ $T_{\text{opaque}}(11\mu\text{m}) < 263$ K	263 K $\leq$ $T_{\text{opaque}}(11\mu\text{m}) < 273$ K
Met-8 SEVIRI	0.40	0.40	0.40	0.40
Met-9 SEVIRI	0.40	0.40	0.40	0.40
<i>Terra</i> MODIS	0.40	0.40	0.40	0.40
<i>Aqua</i> MODIS	0.40	0.40	0.40	0.40
GOES-R ABI	0.40	0.40	0.40	0.40

**Table 24: “MP\_Thresh3” threshold values used in the Mixed Phase (MP) Test as a function of sensor and 11  $\mu\text{m}$  opaque cloud temperature ( $T_{\text{opaque}}(11\mu\text{m})$ ).**

Sensor	233 K $\leq$ $T_{\text{opaque}}(11\mu\text{m}) < 243$ K	243 K $\leq$ $T_{\text{opaque}}(11\mu\text{m}) < 253$ K	253 K $\leq$ $T_{\text{opaque}}(11\mu\text{m}) < 263$ K	263 K $\leq$ $T_{\text{opaque}}(11\mu\text{m}) < 273$ K
Met-8 SEVIRI	1.40	1.35	1.30	1.25
Met-9 SEVIRI	1.40	1.35	1.30	1.25
<i>Terra</i> MODIS	1.25	1.20	1.15	1.10
<i>Aqua</i> MODIS	1.25	1.20	1.15	1.10

GOES-R ABI	1.40	1.35	1.30	1.25
---------------	------	------	------	------

**Table 25: “MP\_Thresh4” threshold values used in the Mixed Phase (MP) Test as a function of sensor and 11  $\mu\text{m}$  opaque cloud temperature ( $T_{\text{opaque}}(11\mu\text{m})$ ).**

#### **3.4.2.6.16 Supercooled Liquid Water (SLW) Test**

**Purpose:** Determine if a cloud is potentially composed of supercooled liquid water.

**Inputs:**

- $T_{\text{opaque}}(11\mu\text{m})$

**Logic:**

If ( $T_{\text{opaque}}(11\mu\text{m}) < 273.16 \text{ K}$  AND  $T_{\text{opaque}}(11\mu\text{m}) > 170.0 \text{ K}$ )

Output = TRUE (the cloud is potentially composed of supercooled liquid water)

**Else**

Output = FALSE

**Thresholds and rationale:**

The 11- $\mu\text{m}$  opaque cloud temperature ( $T_{\text{opaque}}(11\mu\text{m})$ ) is used to determine if a liquid water phase cloud is at a temperature lower than the melting point of water (273.16 K).

#### **3.4.2.6.17 Determining Cloud Type from Test Results**

Once the results from all of the individual tests described in Section 3.4.2.6.1 through Section 3.4.2.6.16 have been compiled, the cloud type is determined using a simple decision tree, which is shown in Figure 12. The decision tree requires the results from the Overall Multilayered Cloud (OMC) Test (Section 3.4.2.6.7), the Overall Ice Cloud (OIC) Test (Section 3.4.2.6.13), the Sub-classify Ice Cloud (SCIC) Test (Section 3.4.2.6.14), the Mixed Phase (MP) Test (Section 3.4.2.6.15), and the Supercooled Liquid Water (SLW) Test (Section 3.4.2.6.16).

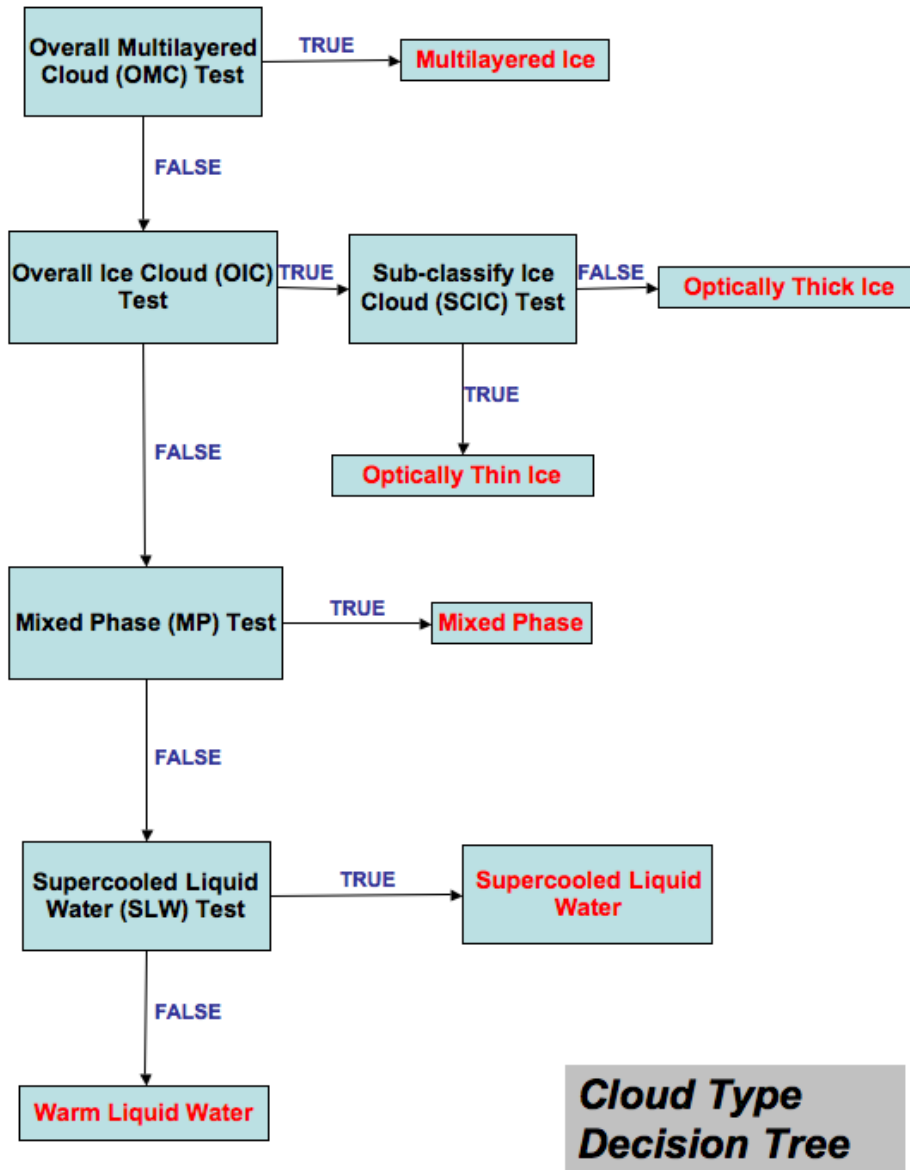

Figure 12: A flow chart of the decision tree used to determine cloud type using the results of several logical tests described in Section 3.4.2.6.1 through Section 3.4.2.6.16 is shown.



### 3.4.2.7 Noise Filtering

In order to remove any visual artifacts associated with the use of the LRC technique described in Section 3.4.2.4, the cloud type product is run through a standard median filter. The median filter simply replaces the value at each pixel with the median value of a 3 x 3 pixel array centered on that pixel. Figure 13 shows that the median filter is effective at removing spatial artifacts without impacting the scientific integrity of the product. Care is exercised so that pixels that were flagged as cloudy before the median filter retain a valid cloud type after the filtering, while pre-median filter clear pixels remained tagged as such after the filtering. In other words, the finished cloud type and cloud phase product are always consistent with the cloud mask. The generic median filter procedure is described in detail in the AIADD Document.

DRAFT

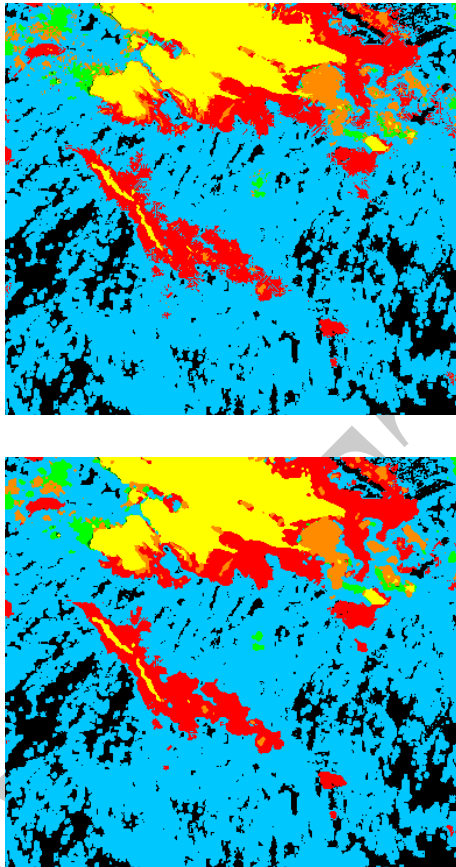

**Figure 13:** The impacts of the median filter are shown. Unfiltered cloud type output is shown on the top and filtered cloud type output on the bottom. Note how the median filter removes artifacts near the edge of the different cloud categories indicated by different colors.

### 3.4.2.8 Determining Cloud Phase from Cloud Type

The cloud phase categories are derived directly from the cloud type categories. The category conversion rules are shown in Table 26.

**Table 26: Correspondence between cloud phase and cloud type categories.**

Cloud Phase Category	Corresponding Cloud Type Categories
Clear	Clear
Liquid Water Phase	Liquid Water

Supercooled Water Phase	Supercooled Water
Mixed Phase	Mixed Phase
Ice Phase	Thick Ice, Thin Ice, and Multilayered Ice

### 3.4.3 Algorithm Output

#### 3.4.3.1 Product Output

The final output of this algorithm is an 8-category cloud typing and a 5-category cloud phase. The output values and description of their meaning is provided in Table 27 and Table 28.

**Table 27: A description of the cloud type output.**

Category	Description	Value
Clear	Confidently clear according to cloud mask	0
Spare	Spare	1
Liquid Water	Liquid water cloud with an opaque cloud temperature greater than 273 K	2
Supercooled Liquid Water	Liquid water topped cloud with an opaque cloud temperature less than 273 K	3
Mixed Phase	High probability of containing liquid water and ice near cloud top	4
Optically Thick Ice	High emissivity ice topped clouds with an infrared optical depth greater than 2.0	5
Optically Thin Ice	Ice clouds which have an infrared optical depth of about 2.0 or less	6
Multilayered Ice	Semi-transparent ice cloud overlapping a lower, opaque cloud layer	7
Cloud type could not be determined	Unable to determine cloud phase due to bad input data	8

**Table 28: A description of the cloud phase output.**

Category	Description	Value
Clear	Confidently clear according to cloud mask	0
Liquid Water	Liquid water cloud with an opaque cloud temperature greater than 273 K	1
Supercooled Liquid Water	Liquid water topped cloud with an opaque cloud temperature less than 273 K	2
Mixed Phase	High probability of containing liquid water and ice near cloud top	3

Ice	All ice topped clouds	4
Cloud phase could not be determined	Unable to determine cloud phase due to bad input data	5

### 3.4.3.2 Quality Flags (QF)

A complete and self-contained description of the GOES-R ABI cloud type/phase quality flag output is listed in Table 29.

Bit(s)	QF Description	Bit Interpretation
1	<b>Overall cloud phase/type product quality flag</b> - the overall quality will be set to “low quality” if any of the more specific quality flags listed below are set to “low quality”	0 = high quality 1 = low quality
2	<b>L1b quality flag</b> – this will be set to “low quality” if any of the spectral data used in the algorithm is of low quality, based on L1b calibration flags	0 = high quality spectral data 1 = low quality spectral data
3	<b>Beta quality flag</b> – this will be set to “low quality” if $\beta_{\text{stropo}}(12/11\mu\text{m})$ , $\beta_{\text{sopaque}}(12/11\mu\text{m})$ , $\beta_{\text{stropo}}(8.5/11\mu\text{m})$ , or $\beta_{\text{sopaque}}(8.5/11\mu\text{m})$ fall outside of the 0.1 – 10.0 range	0 = high quality beta calculation 1 = low quality beta calculation
4	<b>Ice cloud quality flag</b> – this will be set to “low quality” if the cloud phase was determined to be ice and the $\epsilon_{\text{stropo}}(11\mu\text{m}) < 0.05$	0 = ice cloud determination based on strong radiative signal 1 = ice cloud determination based on weak radiative signal (low quality)
5	<b>Surface emissivity quality flag</b> – this will be set to “low quality” if the result of the Low Surface Emissivity (LSE) Test is TRUE and the result of the Overall Opaque Cloud (OOC) Test is FALSE	0 = surface emissivity does NOT significantly impact product quality 1 = surface emissivity significantly impacts product quality (low quality)
6	<b>Satellite zenith angle quality flag</b> – this will be set to “low quality” if the cosine of the satellite zenith angle is less than 0.15 (~82 degrees)	0 = satellite zenith angle does NOT significantly impact product quality 1 = satellite zenith angle significantly impacts product quality (low quality)

**Table 29: A complete description of the cloud type/phase quality flag output is shown.**

### 3.4.3.3 Product Quality Information (PQI)

A complete and self-contained description of the GOES-R ABI cloud type/phase Product Quality Information (PQI) output is listed in Table 30.

Bit(s)	PQI Description	Bit Interpretation
1	Pixel is earth geolocated, has valid spectral data, and is cloudy	0 = FALSE 1 = TRUE
2	Pixel has a valid Local Radiative Center (LRC) (e.g. valid LRC array indices are available for the current pixel)	0 = FALSE 1 = TRUE
3	Result of Low Surface Emissivity (LSE) Test (see Section 3.4.2.6.1)	0 = FALSE 1 = TRUE
4	Result of $\beta_{\text{sopaque}}(12/11\mu\text{m})$ Opaque Cloud (BOC) Test (see Section 3.4.2.6.2)	0 = FALSE 1 = TRUE
5	Result of Opaque Cloud Temperature Difference (OCTD) Test (see Section 3.4.2.6.3)	0 = FALSE 1 = TRUE
6	Result of Overall Opaque Cloud (OOC) Test (see Section 3.4.2.6.4)	0 = FALSE 1 = TRUE
7	Result of Water Vapor Multilayered Detection (WVMD) Test (see Section 3.4.2.6.5)	0 = FALSE 1 = TRUE
8	Result of Infrared Window Multilayered Detection (IWMD) Tests (see Section 3.4.2.6.6)	0 = FALSE 1 = TRUE
9	Result of Overall Multilayered Cloud (OMC) Test (see Section 3.4.2.6.7)	0 = FALSE 1 = TRUE
10	Result of Homogeneous Freezing (HF) Test (see Section 3.4.2.6.8)	0 = FALSE 1 = TRUE
11	Result of $\beta_{\text{sopaque}}(8.5/11\mu\text{m})$ and Water Vapor Ice Cloud (BOWVIC) Test (see Section 3.4.2.6.9)	0 = FALSE 1 = TRUE
12	Result of $\beta_{\text{sopaque}}(8.5/11\mu\text{m})$ and Water Vapor Ice Cloud LRC-only (BOWVIC-LRC) Test (see Section 3.4.2.6.10)	0 = FALSE 1 = TRUE
13	Result of $\beta_{\text{sopaque}}(8.5/11\mu\text{m})$ Opaque Ice Cloud (BOIC) Test (see Section 3.4.2.6.11)	0 = FALSE 1 = TRUE
14	Result of $\beta_{\text{stropo}}(8.5/11\mu\text{m})$ and Water Vapor Ice Cloud (BTWVIC) Test (see Section 3.4.2.6.12)	0 = FALSE 1 = TRUE
15	Result of Overall Ice Cloud (OIC) Test (see Section 3.4.2.6.13)	0 = FALSE 1 = TRUE
16	Result of Sub-classify Ice Cloud (SCIC) Test (see Section 3.4.2.6.14)	0 = FALSE 1 = TRUE
17	Result of Mixed Phase (MP) Test (see Section	0 = FALSE

	3.4.2.6.15)	1 = TRUE
18	Result of Supercooled Liquid Water (SLW) Test (see Section 3.4.2.6.16)	0 = FALSE 1 = TRUE
19-22	Pixel cloud type result prior to applying the median filter (see Section 3.4.2.7)	See Table 27

**Table 30: A complete description of the cloud type/phase Product Quality Information (PQI) output is shown.**

### 3.4.3.4 Product Metadata

A complete and self-contained description of the GOES-R ABI cloud type/phase metadata output is listed in Table 31.

Metadata Description
Number of cloud phase categories (5 categories)
Definition of clear cloud phase category
Definition of warm liquid water cloud phase category
Definition of supercooled liquid water cloud phase category
Definition of mixed cloud phase category
Definition of ice cloud phase category
Percent of clear pixels
Percent of warm liquid water cloud pixels
Percent of supercooled liquid water cloud pixels
Percent of mixed phase cloud pixels
Percent of ice phase cloud pixels
Total number of cloudy pixels
Percent of pixels with each QF flag value

**Table 31: A complete description of the cloud type/phase metadata output is shown.**

## 4 TEST DATA SETS AND OUTPUTS

### 4.1 Simulated/Proxy Input Data Sets

The data used to test the ABI Cloud Phase/Type consists of Spinning Enhanced Visible and Infrared Imager (SEVIRI) observations. The cloud phase/type is validated using the Cloud-Aerosol Lidar with Orthogonal Polarization (CALIOP) on-board the Cloud-Aerosol Lidar and Infrared Pathfinder Satellite Observation (CALIPSO) satellite. Both of these data sets are briefly described below

#### 4.1.1 SEVIRI Data

SEVIRI provides 11 spectral channels with a spatial resolution of 3 km and provides spatial coverage of the full disk with a temporal resolution of 15 minutes. SEVIRI provides the best source of data currently for testing and developing the cloud phase/type. The SEVIRI to ABI channel mapping is shown in Table 32. [Figure 14](#), shown below, is a full-disk SEVIRI image from 12 UTC on November 24, 2006. SEVIRI data are readily available from the University of Wisconsin Space Science and Engineering Center (SSEC) Data Center.

Wayne Mackenzie 6/11/13 10:41 PM  
Deleted: Figure 14

SEVIRI Band Number	SEVIRI Wavelength Range ( $\mu\text{m}$ )	SEVIRI Central Wavelength ( $\mu\text{m}$ )	ABI Band Number	ABI Wavelength Range ( $\mu\text{m}$ )	ABI Central Wavelength ( $\mu\text{m}$ )
6	6.85 – 7.85	7.30	10	7.30 – 7.50	7.40
7	8.30 – 9.10	8.70	11	8.30 – 8.70	8.50
9	9.80 – 11.80	10.80	14	10.80 – 11.60	11.20
10	11.00 – 13.00	12.00	15	11.80 – 12.80	12.30

**Table 32: The SEVIRI bands used to test the ABI cloud phase and type algorithm is shown relative to the corresponding ABI bands.**



**Figure 14: SEVIRI RGB image from 12 UTC on November 24, 2006.**

#### 4.1.1.1 CALIOP Data

With the launch of the Cloud-Aerosol Lidar and Infrared Pathfinder Satellite Observation (CALIPSO) into the EOS A-train in April 2006, the ability to validate satellite-based cloud and aerosol products increased significantly. The Cloud-Aerosol Lidar with Orthogonal Polarization (CALIOP) on-board the CALIPSO satellite is a dual wavelength depolarization lidar. CALIPSO is in an afternoon sun-synchronous low earth orbit. Thus, it can be closely co-located in space and time with the SEVIRI at certain times of the day. We will primarily use the CALIOP cloud layer product to validate the ABI cloud phase and cloud type products. The CALIOP vertical cloud boundaries can be combined with co-located NWP temperature profiles to provide a good estimate of cloud top temperature, which can be used to infer cloud top phase for certain temperature ranges. The CALIOP cloud phase product is not used at this time because the current version is not accurate due to the complexities of multiple scattering and oriented ice crystals (Hu et al., 2009). The next version should address some of these deficiencies (Hu et al., 2009). The CALIOP cloud boundaries can also be used to calculate a quality estimate of the true cloud emissivity, as in Heidinger and Pavolonis (2009). The horizontal resolution of the CALIOP cloud layer data used in the validation is 1-km. An example 1-km CALIOP cross section is shown in [Figure 15](#). All of the validation data

Wayne Mackenzie 6/11/13 10:41 PM

Deleted: Figure 15



sources and procedures, including CALIOP, are described in detail the ABI Cloud Products Validation Plan Document.

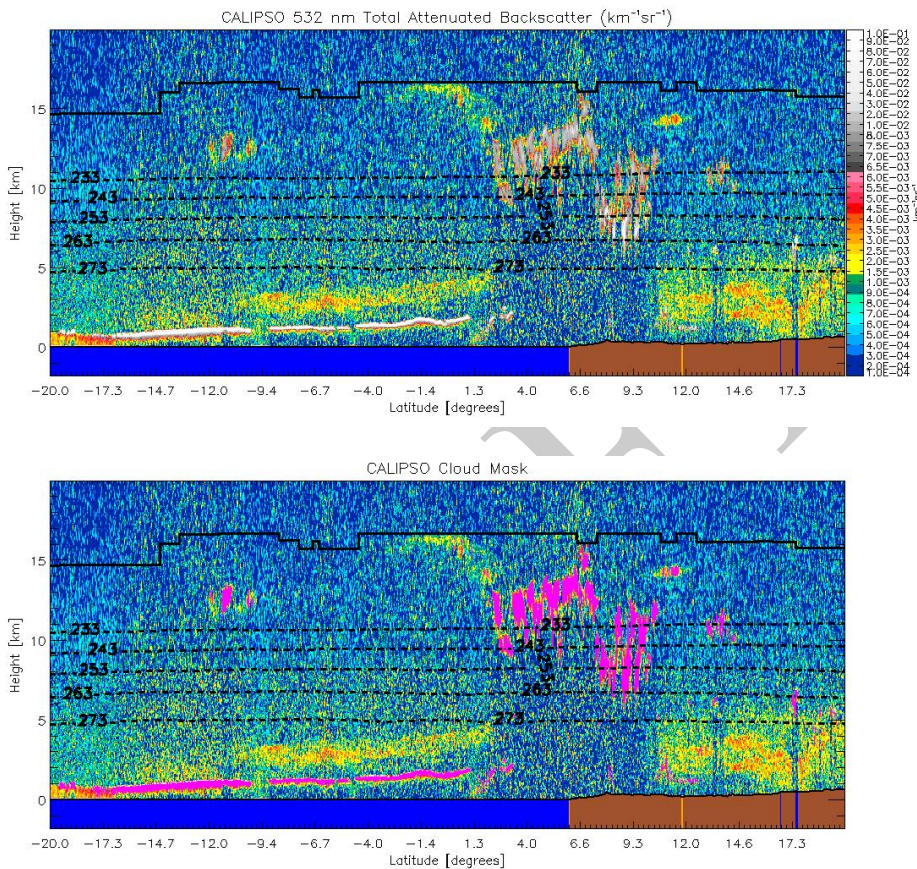

**Figure 15: Illustration of the CALIPSO data used in this study. Top image shows a 2d backscatter profile. Bottom image shows the detected cloud layers overlaid onto the backscatter image. Cloud layers are color magenta.**

## 4.2 Output from Simulated/Proxy Inputs Data Sets

The ABI cloud phase/type was tested on many SEVIRI full disks. As an example, results from November 25, 2005 at 12 UTC are shown below. A more detailed zoomed in view of a smaller region is also shown. Note that the results match the phase indicated by the

false color images well (magenta=ice and yellow=water in the false color imagery). A more quantitative validation is shown in the next section.

As shown at the Test Readiness Review (TRR), the cloud phase and type output from the online (Framework) and offline (Cloud AWG) processing systems match exactly. These tests were conducted under different conditions using the same input for both the online and offline tests.

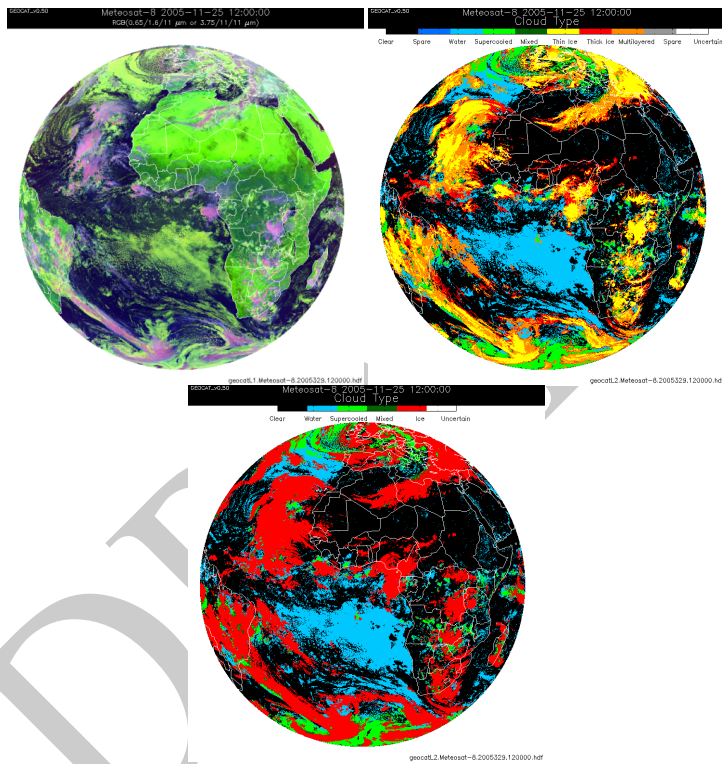

**Figure 16: Example results (using SEVIRI) from the ABI cloud typing and cloud phase algorithms for November 25, 2005. The top, left panel is a RGB false color image and the top, right and bottom, left panels show the cloud type and cloud phase results, respectively.**

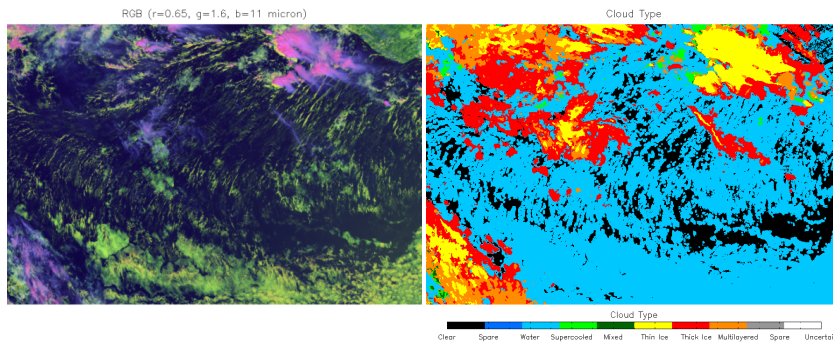

**Figure 17:** A more detailed look at the cloud type results shown in [Figure 16](#) for a small region near the Ivory Coast of Africa.

Wayne Mackenzie 6/11/13 10:41 PM

Deleted: Figure 16

#### 4.2.1 Precisions and Accuracy Estimates

To estimate the precision and accuracy of the ABI Cloud Phase/Type, comparisons to CALIOP data from the NASA EOS A-train were performed. CALIOP provides unprecedented information on cloud and aerosol vertical structure and horizontal location on a global scale. While CALIOP provides an unprecedented view of clouds, especially in regards to cloud location (both in the vertical and horizontal), it does not provide a direct measurement of cloud phase. Cloud phase must be retrieved. As discussed in Section 3.4.2.5, the current CALIOP cloud phase product is not considered to be accurate (Hu et al, 2009), and as such, is not suitable for validating the ABI cloud phase/type algorithm at this time. Thus, we decided to mainly focus on using the CALIOP cloud boundaries along with NWP temperature profiles to identify clouds with a cloud top temperature less than 233 K (definite ice clouds) and clouds with a cloud top temperature ( $T_{\text{cld}}$ ) greater than 273 K (definite liquid water clouds). Fundamental thermodynamic and cloud physics theory dictates that liquid water is exceedingly unlikely at temperatures less than 233 K and ice is not possible at temperatures greater than 273 K. In addition, Korolev et al. (2003) sampled a large number of mid-level clouds with aircraft probes and found that for in-cloud temperatures in the 268 – 273 K range, liquid water dominated. Conversely, Korolev et al. (2003) also found that for in-cloud temperatures in the 233 – 238 K range, ice is by far the dominant phase. Given these in-situ observations, the “definite” liquid water phase and “definite” ice phase categories derived from CALIOP are expanded to  $T_{\text{cld}} \geq 268$  K and  $T_{\text{cld}} \leq 238$  K, respectively. At the present, potentially mixed phase clouds ( $268 \text{ K} < T_{\text{cld}} < 238 \text{ K}$ ) cannot be validated, mainly because of a lack of truth data. As will be shown, potentially mixed phase clouds (when the mixed phase cloud is the highest cloud layer) are not as common as liquid water or ice clouds. As such, even if large errors are assumed, the cloud phase algorithm will meet the accuracy specifications. Nevertheless, future “deep dive” validation efforts will focus on validating potentially mixed phase clouds as CALIOP retrievals improve and as combined CALIOP and CloudSat (spaceborne cloud radar) data products mature.

## 4.2.2 Error Budget

The ABI Cloud Phase/Type was applied to SEVIRI then compared to CALIOP using the cloud top temperature classification discussed in the previous section.

### 4.2.2.1 Cloud Phase Error Budget

Cloud phase validation results are shown in Table 33 and Table 34. Note that the liquid water and supercooled water categories are combined, since differences between the two categories are solely a function of the measured 11- $\mu\text{m}$  brightness temperature. The validation data set consists of 95,000 SEVIRI/CALIOP cloudy match-ups, covering all seasons. Potentially mixed phase clouds are not included in the total error estimate shown in these tables. The impact of errors in the classification of potentially mixed phase clouds will be discussed shortly. The statistics shown in Table 33 includes all clouds detected by the ABI cloud mask, many of which have an optical depth (at visible wavelengths)  $< 1.0$ . According to the F&PS, the accuracy specifications (20% error for cloud phase and 40% error for cloud type) only apply to clouds with an optical greater than 1.0. As the cloud phase validation results show, when potentially mixed phase clouds are not considered, the ABI Cloud Phase comfortably meets the accuracy specification (cloud phase specification: 20% error) without invoking the optical depth qualifier. Note how the liquid water and ice phase categories each meet the accuracy specification when considered alone. Table 34 shows the validation statistics when clouds with an optical depth  $> 1.0$  are filtered out (based on the cloud emissivity calculated using the CALIOP cloud boundaries) per the product accuracy qualifier.

**Table 33: ABI cloud phase validation statistics *without* invoking minimum cloud optical depth qualifier are shown. The liquid water and supercooled water categories are combined since differences between the two categories are solely a function of the measured 11- $\mu\text{m}$  brightness temperature. Potentially mixed phase clouds ( $268 \text{ K} < T_{\text{cld}} < 238 \text{ K}$ ) are counted in the total statistics.**

Category	CALIOP Count	ABI Phase Count	Percent Agree	Percent Disagree
Liquid Water/ Supercooled Water	49,642	44,915	90.48%	9.52%
Potentially Mixed Phase	21,434 (not counted in total)	TBD	TBD	TBD
Ice Phase	45,607	38,693	84.84%	15.16%
<b>Total</b>	<b>95,249</b>	<b>83,608</b>	<b>87.78%</b>	<b>12.22%</b>

**Table 34: Same as Table 33, except the minimum cloud optical depth qualifier is invoked.**

Category	CALIOP Count	ABI Phase Count	Percent Agree	Percent Disagree
Liquid Water/ Supercooled Water	34,446	31,105	90.30%	9.70%
Potentially Mixed Phase	13,087 (not counted in total)	TBD	TBD	TBD
Ice Phase	17,597	17,322	98.44%	1.56%
<b>Total</b>	<b>52,043</b>	<b>48,427</b>	<b>93.05%</b>	<b>6.95%</b>

The cloud phase errors shown in Table 33 and Table 34 do not include clouds that have a cloud top temperature ( $T_{\text{cld}}$ ) that is  $268 \text{ K} < T_{\text{cld}} < 238 \text{ K}$  because accurate validation of potentially mixed phase clouds using CALIOP is not possible at this time. In lieu of validating these clouds, we calculated the maximum error in classifying potentially mixed phase clouds that can be tolerated while still meeting the accuracy specification overall. Figure 18 shows the total cloud phase error as a function of the assumed error in classifying potentially mixed phase clouds with and without the minimum cloud optical depth qualifier. Note in Table 33 and Table 34 that the potentially mixed phase category is the least populated category. Because of this, very large errors in the classification of potentially mixed phase clouds can be tolerated. Figure 18 indicates that errors as large as 54% and 72% can be tolerated **without** and **with** the minimum cloud optical depth qualifier, respectively. While we will strive to validate this category and achieve as much skill as possible, this type of cloud does not pose a serious overall risk.

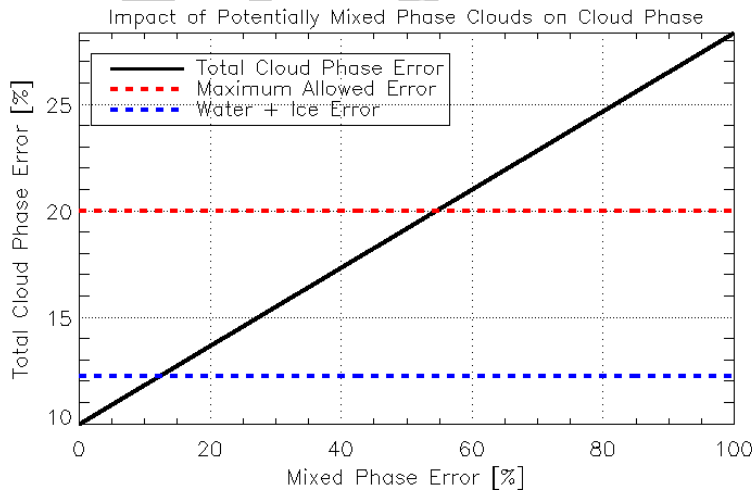

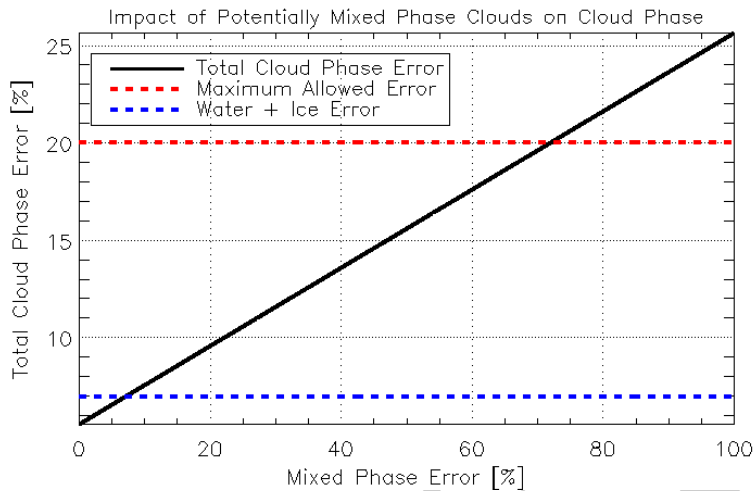

**Figure 18:** The total cloud phase error as a function of the assumed error in classifying potentially mixed phase clouds is shown when the minimum cloud optical depth qualifier is *ignored* (top) and when it *is applied* (bottom) with the solid black line. The dashed red line is the allowed error from the F&PS. The dashed blue line is the actual accuracy achieved without including potentially mixed phase clouds in the validation analysis.

#### 4.2.2.2 Cloud Type Error Budget

The error budget analysis performed on the cloud phase product was modified slightly and applied to the cloud type product. The only changes made were to break the ice phase category into 3 separate categories, optically thick ice, optically thin ice, and multilayered ice. Single layered ice clouds with an 11- $\mu\text{m}$  (0.65- $\mu\text{m}$ ) optical depth of 1.0 (2.0) or less are defined as optically thin clouds. Other single layer ice clouds are classified as optically thick ice clouds. The true 11- $\mu\text{m}$  cloud optical depth is calculated using CALIOP cloud boundaries as explained previously in Section 3.4.2.5. Multilayered ice cloud is defined as a semi-transparent ice cloud that overlaps a lower cloud layer such that a clear sky layer separates the multiple cloud layers. Given these definitions, the cloud type validation statistics are shown in Table 35 and Table 36, **without** and **with** the minimum cloud optical depth qualifier, respectively. The cloud type product comfortably meets the F&PS accuracy specification (cloud type specification: 40% error) when potentially mixed phase clouds are excluded. The maximum error in classifying potentially mixed phase clouds that can be tolerated while still meeting the cloud type accuracy specification overall is shown in Figure 19 **without** and **with** applying the minimum cloud optical depth qualifier. As was determined for the cloud phase product, errors in classifying potentially mixed phase clouds do not pose a risk to the cloud type product, as the cloud type product will still meet the F&PS accuracy specification even if the error in classifying potentially mixed phase clouds is 100% (when the minimum cloud optical depth qualifier is applied).

**Table 35: ABI cloud type validation statistics *without* invoking minimum cloud optical depth qualifier are shown. The liquid water and supercooled water categories are combined since differences between the two categories are solely a function of the measured 11- $\mu\text{m}$  brightness temperature. Potentially mixed phase clouds ( $268\text{ K} < T_{\text{cld}} < 238\text{ K}$ ) are counted in the total statistics.**

Category	CALIOP Count	ABI Phase Count	Percent Agree	Percent Disagree
Liquid Water/ Supercooled Water	49,642	44,915	90.48%	9.52%
Potentially Mixed Phase	21,434 (not counted in total)	TBD	TBD	TBD
Optically Thick Ice	5763	4975	86.33%	13.67%
Optically Thin Ice	15,689	9183	58.53%	41.47%
Multilayered Ice	24,155	9570	39.62%	60.38%
<b>Total</b>	<b>95,249</b>	<b>68,643</b>	<b>72.07%</b>	<b>27.93%</b>

**Table 36: Same as Table 35, except the minimum cloud optical depth qualifier *is* invoked.**

Category	CALIOP Count	ABI Phase Count	Percent Agree	Percent Disagree
Liquid Water/ Supercooled Water	34,446	31,105	90.30%	9.70%
Potentially Mixed Phase	13,087 (not counted in total)	TBD	TBD	TBD
Optically Thick Ice	5752	4965	86.32%	13.68%
Optically Thin Ice	5482	2716	49.54%	50.46%
Multilayered Ice	6363	3612	56.77%	43.23%
<b>Total</b>	<b>52,043</b>	<b>42,398</b>	<b>81.47%</b>	<b>18.53%</b>

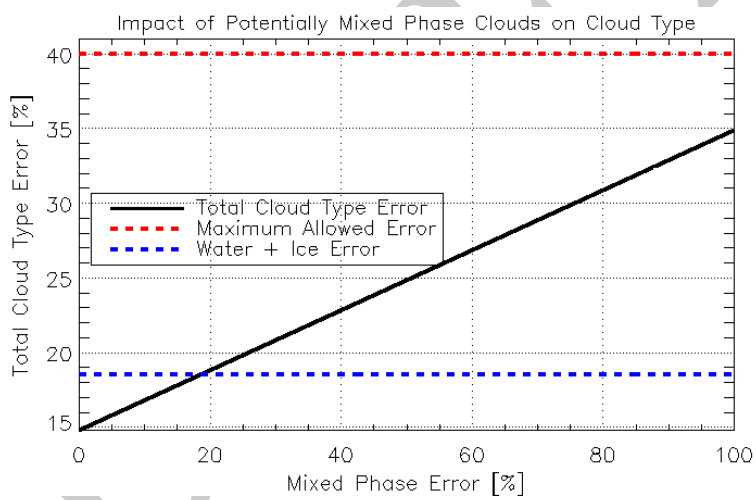
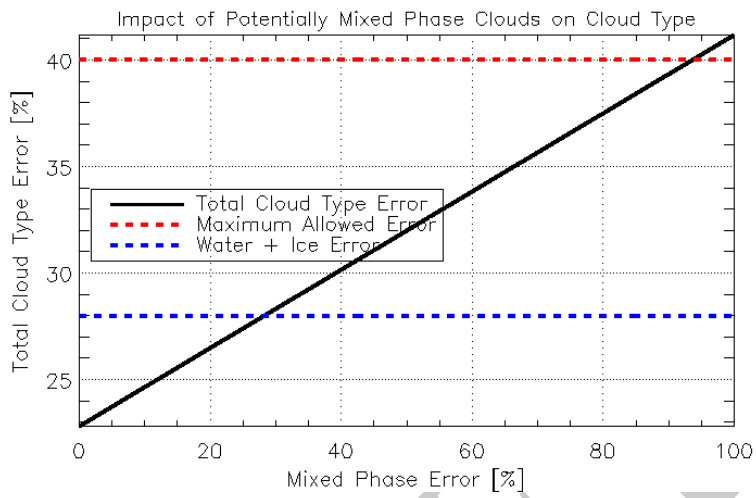

**Figure 19: Same as Figure 18, except for cloud type.**

### 4.2.3 Validation Summary

The following points summarize the results of the cloud phase and type validation.

- According to the F&PS, the cloud phase product must correctly classify 80% of clouds with an optical depth (visible wavelength optical depth) greater than 1.0.



- According to the F&PS, the cloud type product must correctly classify 60% of clouds with an optical depth (visible wavelength optical depth) greater than 1.0.
- A small subset (relative to all other cloud classes) of mid-level clouds termed, “potentially mixed phase clouds,” was excluded from the validation analysis due to the lack of quality validation data.
- The validation analysis was performed **with** and **without** invoking the greater than 1.0 cloud optical depth qualifier.
- The cloud phase product correctly classifies 93% of clouds **with** the cloud optical depth qualifier and 88% of clouds **without** the cloud optical depth qualifier, both of which are well within the F&PS accuracy specification.
- The cloud type product correctly classifies 82% of clouds **with** the cloud optical depth qualifier and 72% of clouds **without** the cloud optical depth qualifier, both of which are well within the F&PS accuracy specification.
- The analysis also indicates that the exclusion of “potentially mixed phase clouds” from the analysis will not prevent the cloud phase and type products from meeting the F&PS accuracy specifications, as very large errors in classifying “potentially mixed phase clouds” can be tolerated.
- Remaining validation efforts will focus on performing a detailed analysis of “potentially mixed phase clouds” through the development of multi-sensor “deep dive” tools. Regardless of the results of this “deep dive” analysis, the cloud phase and type products meet the F&PS accuracy specifications.

## 5 PRACTICAL CONSIDERATIONS

### 5.1 Numerical Computation Considerations

Prior to converting cloud emissivity to optical depth, the cloud emissivity must be checked to ensure that it is greater than 0.0 and less than 1.0 to prevent an illegal natural logarithm operation.

### 5.2 Programming and Procedural Considerations

The ABI Cloud Phase/Type makes heavy use of clear-sky radiative transfer calculations. Our current system computes the clear-sky atmospheric transmittances at low spatial resolution and with enough angular resolution to capture sub-grid variation path-length changes. This step is critical, as performing clear-sky atmospheric transmittance calculations for each pixel requires extensive memory and CPU time, but does not

produce significantly better scientific results. The AIADD Document describes this procedure in detail.

NWP data is heavily utilized in the ABI cloud type/phase algorithm. The algorithm can tolerate the use NWP data for forecasts ranging from 0 to 24 hours.

The ABI Cloud Phase/Type algorithm can provide usable results out to a viewing angle of 80 degrees (the F&PS minimum requirement is 65 degrees). The cloud phase/type algorithm is not applied to pixels that have a viewing angle greater than 80 degrees (the cloud phase and cloud type are set to zero in this case).

### **5.3 Quality Assessment and Diagnostics**

It is recommended that clear sky radiance biases are regularly monitored and that the validation exercises described earlier are applied routinely. Further, algorithm performance issues are best diagnosed by examining the  $\beta$ -ratios used to make cloud type decisions.

### **5.4 Exception Handling**

Prior to use, the ABI Cloud Phase/Type checks to make sure that each channel falls within the expected measurement range and that valid clear sky radiance and transmittance profiles are available for each channel. The ABI Cloud Phase/Type is only applied to a given pixel if all channels used in the algorithm contain valid data (according to the L1b calibration flags); otherwise the algorithm output is flagged as missing. The science of the cloud phase/type algorithm does not allow for a graceful degradation of the products at this time. The algorithm, however, can tolerate the use NWP data for forecasts ranging from 0 to 24 hours.

### **5.5 Algorithm Validation**

Cloud phase/type products derived from spaceborne lidar or ground-based lidar and cloud radar will serve as the main source of validation data. During the GOES-R pre-launch period, CALIOP will serve as the main source of validation, as described earlier. During the post-launch period, spaceborne lidar data from the European Space Agency (ESA) EarthCARE mission will be used in validation (pending a successful and on-time mission). In the absence of EarthCARE, the combination of ground-based lidar and millimeter cloud radar, such as those deployed by the Atmospheric Radiation Measurement (ARM) program, will be used for validation. Please refer to the ABI Cloud Products Validation Plan Document for extensive information on pre and post launch validation plans.

## 6 ASSUMPTIONS AND LIMITATIONS

The following sections describe the current limitations and assumptions in the current version of the ABI Cloud Phase/Type Algorithm.

### 6.1 Performance

The following assumptions have been made in developing and estimating the performance of the ABI Cloud Phase/Type. The following lists contain the current assumptions and proposed mitigation strategies.

1. NWP data of comparable or superior quality to the current 6 hourly GFS forecasts are available. (Mitigation: Use longer-range GFS forecasts or switch to another NWP source – e.g. ECMWF).
2. Top-of-atmosphere clear sky radiances are available for each pixel and 101 level profiles of clear sky atmospheric transmittance and radiance are available at the NWP data horizontal resolution. (Mitigation: Use reduced spatial resolution top-of-atmosphere clear sky radiances. The profiles of transmittance and radiance must be present at, at least, the NWP spatial resolution and 101 vertical levels).
3. All of the static ancillary data are available at the pixel level. (Mitigation: Reduce the spatial resolution of the surface type, land mask and or coast mask).
4. The processing system allows for processing of multiple scan lines at once for application of important spatial analysis techniques. (Mitigation: No mitigation is possible).
5. All ABI channels required (see [Table 3](#)) by the algorithm must be available. (Mitigation: Develop a modified version of the algorithm. Graceful degradation is not possible because there are too many possible channel permutations.).

In addition, the clear sky radiance calculations are prone to large errors, especially near coastlines, in mountainous regions, snow/ice field edges, and atmospheric frontal zones, where the NWP surface temperature and atmospheric profiles are less accurate. The impact of these errors on the cloud phase/type depends on the cloud optical depth. For optically thick clouds (infrared optical depth of about 1.0 or greater), these errors have a small impact on the calculation of the effective absorption optical depth ratios since the difference between the observed and black cloud radiance approaches zero as the cloud optical depth increases. This is not the case for optically thin clouds, where inaccurate NWP data can have serious impacts. The ACT algorithm utilizes the Local Radiative Center (LRC) (see 3.4.2.4 for details) concept to minimize these impacts, but

Wayne Mackenzie 6/11/13 10:41 PM  
Deleted: Table 3

improvements in NWP fields should lead to additional improvements in the ABI Cloud Phase/Type products.

## **6.2 Assumed Sensor Performance**

We assume the sensor will meet its current specifications. However, the ABI Cloud Phase/Type will be dependent on the following instrumental characteristics.

- Unknown spectral shifts in some channels will cause biases in the clear-sky RTM calculations that may impact the performance of the ABI Cloud Phase/Type. Clear sky radiance biases need to be monitored throughout ABI's lifetime.

## **6.3 Pre-Planned Product Improvements**

We expect in the coming years to focus on the following improvements.

### **6.3.1 Incorporation of solar channels**

Channels that are sensitive to reflected solar radiation are very useful for providing additional information on cloud phase. Future version of the ABI Cloud Phase/Type may include an enhanced daytime version that utilizes these channels.

### **6.3.2 Use of 10.4- $\mu\text{m}$ channel**

The 10.4  $\mu\text{m}$  channel is new to the world of satellite imagers. Large variations in cloud emissivity occur in the 10 – 13  $\mu\text{m}$  spectral range. With the 10.4  $\mu\text{m}$  channel additional cloud emissivity relationships can be exploited in determining cloud phase and type. We expect to incorporate this channel into the ABI Cloud Phase/Type to improve our cloud phase determination. We expect the GOES-R Risk Reduction projects to demonstrate its use before implementation into the operational algorithm.

### **6.3.3 Use of additional water vapor channels**

Stronger absorbing water vapor channels (ABI channels 8 and 9) can be used to improve the multilayered cloud detection. Future versions of the algorithm may incorporate these channels.

## 7 REFERENCES

- Carey, L. D., J. Niu, P. Yang, J. A. Kankiewicz, V. E. Larson, and T. H. Vonder Haar, 2008: The vertical profile of liquid and ice water content in midlatitude mixed-phase altocumulus clouds. *J. Appl. Meteorol. And Climatology*, **47**, 2487-2495.
- Cober, S. G., G. A. Isaac, A. V. Korolev, and J. W. Strapp, 2001: Assessing Cloud-Phase Conditions. *J. Appl. Meteorol.*, **40**, 1967-1983.
- Cox, S. K., 1976: Observations of Cloud Infrared Effective Emissivity. *J. Atmos. Sci.*, **33**, 287-289.
- Downing, H. D., D. Williams, 1975: Optical-Constants of Water in Infrared. *Journal of Geophysical Research*, **80**, 1656-1661.
- Giraud, V., J. C. Buriez, Y. Fouquart, F. Parol, and G. Seze, 1997: Large-scale analysis of cirrus clouds from AVHRR data: Assessment of both a microphysical index and the cloud-top temperature. *J. Appl. Meteorol.*, **36**, 664-675.
- Heidinger, A. K. and M. J. Pavolonis, 2005: Global daytime distribution of overlapping cirrus cloud from NOAA's Advanced Very High Resolution Radiometer. *J. Climate*, **18** (22), 4772-4784.
- Heidinger, A. K. and M. J. Pavolonis, 2009: Nearly 30 years of gazing at cirrus clouds through a split-window. Part I: Methodology. *J. Appl. Meteorol. and Climatology*, **48**(6), 110-1116.
- Hu, Y. and Co-authors, 2009: CALIPSO/CALIOP cloud phase discrimination algorithm. *J. Atmos. and Oceanic Technol.*, In Press (early online release).
- Inoue, T., 1987: A Cloud Type Classification with Noaa 7 Split-Window Measurements. *J. Geophys. Res.-Atmos.*, **92**, 3991-4000.
- Korolev, A. V., G. A. Isaac, S. G. Cober, J. W. Strapp, and J. Hallett, 2003: Microphysical characterization of mixed-phase clouds. *Q. J. R. Meteorol. Soc.*, **129**, 39-65.
- Mitchell, D. L., 2000: Parameterization of the Mie extinction and absorption coefficients for water clouds. *J. Atmos. Sci.*, **57**, 1311-1326.
- Parol, F., J. C. Buriez, G. Brogniez, and Y. Fouquart, 1991: Information-Content of Avhrr Channels 4 and 5 with Respect to the Effective Radius of Cirrus Cloud Particles. *J. Appl. Meteorol.*, **30**, 973-984.

- Pavolonis, M. J., A. K. Heidinger, 2004: Daytime cloud overlap detection from AVHRR and VIIRS. *J.Appl.Meteorol.*, **43**, 762-778.
- Pavolonis, M. J., A. K. Heidinger, and T. Uttal, 2005: Daytime global cloud typing from AVHRR and VIIRS: Algorithm description, validation, and comparisons. *J.Appl.Meteorol.*, **44**, 804-826.
- Pavolonis, M. J., 2010a: Advances in extracting cloud composition information from spaceborne infrared radiances: A robust alternative to brightness temperatures. Part I: Theory. *J. Applied Meteorology and Climatology*, In Press (available online).
- Pavolonis, M. J., 2010b: Advances in extracting cloud composition information from spaceborne infrared radiances: A robust alternative to brightness temperatures. Part II: Proof of concept. To be submitted to the *J. Applied Meteorology and Climatology*.
- Rogers, R. R. and M. K. Yau, 1989: A short course in cloud physics. Third Edition. Butterworth-Heinemann. 290 pp.
- Seemann, S. W., E. E. Borbas, R. O. Knuteson, G. R. Stephenson, and H. Huang, 2008: Development of a global infrared land surface emissivity database for application to clear sky sounding retrievals from multispectral satellite radiance measurements. *J.Appl.Meteorol.Climatol.*, **47**, 108-123, doi:10.1175/2007JAMC1590.1.
- Turner, D. D., 2005: Arctic mixed-phase cloud properties from AERI lidar observations: Algorithm and results from SHEBA. *J.Appl.Meteorol.*, **44**, 427-444.
- Van de Hulst, H. C., 1980: *Multiple Light Scattering, Tables, Formulas, and Applications*. Vol. 2. Academic Press, 739 pp.
- Warren, S. G., R. E. Brandt, 2008: Optical constants of ice from the ultraviolet to the microwave: A revised compilation. *J.Geophys.Res.-Atmos.*, **113**, D14220, doi:10.1029/2007JD009744.
- Yang, P., H. L. Wei, H. L. Huang, B. A. Baum, Y. X. Hu, G. W. Kattawar, M. I. Mishchenko, and Q. Fu, 2005: Scattering and absorption property database for nonspherical ice particles in the near- through far-infrared spectral region. *Appl.Opt.*, **44**, 5512-5523.
- Zhang, H., W. P. Menzel, 2002: Improvement in thin cirrus retrievals using an emissivity-adjusted CO2 slicing algorithm. *J.Geophys.Res.-Atmos.*, **107**, 4327, doi:10.1029/2001JD001037.