

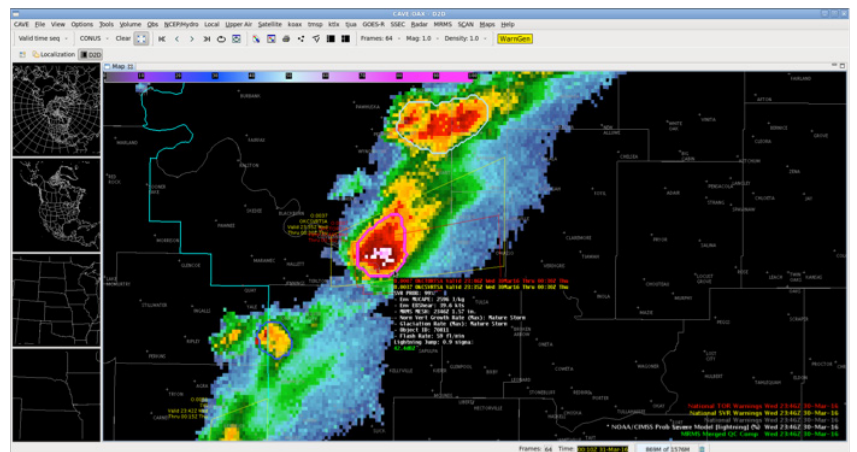

# CIMSS Cooperative Agreement Annual Report

for the period  
1 July 2015 to 31 March 2016

Submitted by the  
Cooperative Institute for  
Meteorological Satellite Studies  
University of Wisconsin-Madison  
April 2016

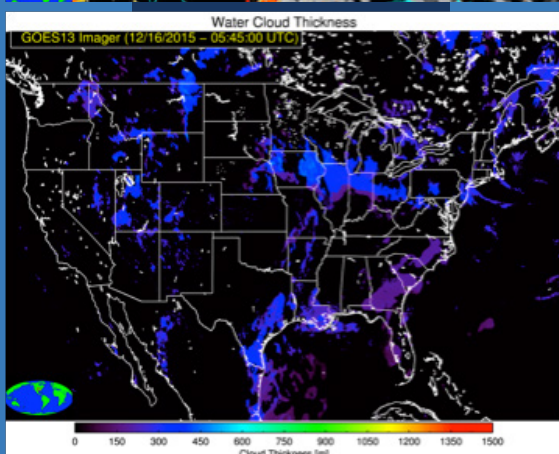
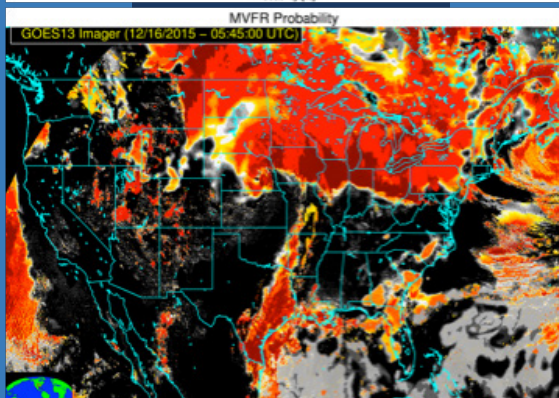
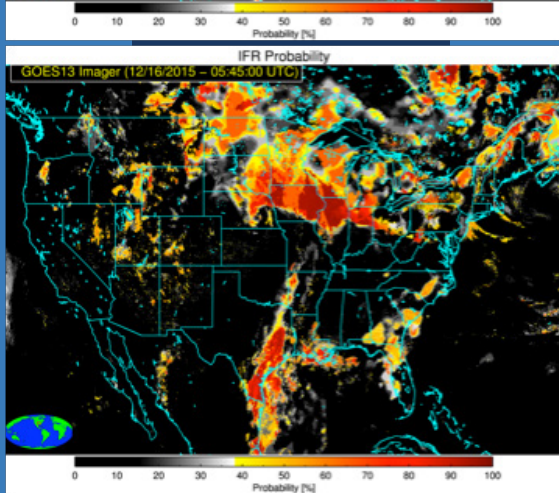
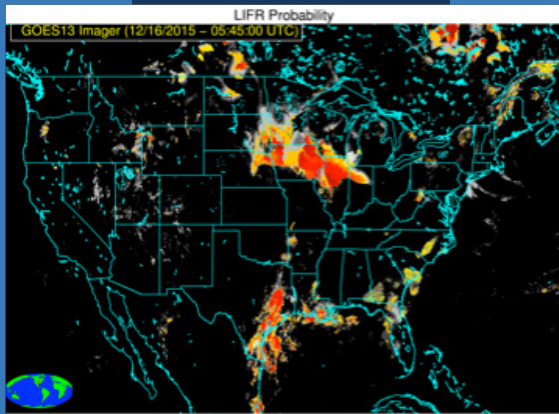

*GOES-R Fog/Low stratus  
(FLS) products*

*ProbSevere Model*



**University of Wisconsin–Madison**

**Cooperative Institute for  
Meteorological Satellite Studies (CIMSS)**

<http://cimss.ssec.wisc.edu/>

---

**Cooperative Agreement  
Annual Report**

**for the period**

**1 July 2015 to 31 March 2016**

**Cooperative Agreement Number: NA15NES4320001**

**Submitted to:  
National Oceanic and Atmospheric  
Administration  
(NOAA)**



**Cooperative Agreement Annual Report  
from the  
Cooperative Institute for Meteorological Satellite Studies  
University of Wisconsin–Madison**

1 July 2015 to 31 March 2016

**Steven Ackerman  
Director, CIMSS**

**Wayne Feltz  
Executive Director-Science, SSEC**

**CIMSS Contributing Task Leaders**

Ackerman, Steve  
Batzli, Sam  
Baum, Bryan  
Borg, Lori  
Botambekov, Denis  
Brunner, Jason  
Calvert, Corey  
Cintineo, John  
Cronce, Lee  
Davies, James  
Feltz, Wayne  
Foster, Michael  
Garcia, Ray  
Gerth, Jordan  
Greenwald, Tom  
Griffin, Sarah  
Gumley, Liam  
Gunshor, Mat  
Hoffman, Jay  
Holz, Robert  
Hoover, Brett  
Huang, Hung Lung  
Hubbard, Shane  
Jasmin, Tommy  
Jung, James  
Knuteson, Robert  
Lee, Yong-Keun  
Lenzen, Allen  
Li, Jun  
Li, Yue  
Li, Zhenglong  
Liu, Yinghui  
Martin, Graeme  
Menzel, W. Paul  
Moeller, Chris  
Mooney, Margaret  
Olander, Tim  
Otkin, Jason

Petersen, Ralph  
Rink, Tom  
Santek, Dave  
Schmidt, Chris  
Sieglaff, Justin  
Strabala, Kathleen  
Straka, William  
Tobin, Dave  
Velden, Christopher  
Wagner, Timothy  
Walther, Andi  
Wang, Pao  
Wang, Xuanji  
Wanzong, Steve  
Weisz, Elisabeth  
Wimmers, Anthony

**ASBP/NCDC Collaborators**

Heidinger, Andy  
Key, Jeff  
Kossin, Jim  
Pavolonis, Mike  
Pierce, Brad  
Schmit, Tim

**Additional Contributors**

Avila, Leanne  
Hackel, Jenny  
Phillips, Jean  
Vasys, Maria



## Table of Contents

<b>I. Director’s Executive Summary</b> .....	<b>14</b>
1. Foster collaborative research between NOAA and UW–Madison in those aspects of atmospheric and earth science that exploit the use of satellite technology.....	14
2. Serve as a center at which scientists and engineers working on problems of mutual interest may focus on satellite related research in atmospheric studies and earth science.....	15
3. Stimulate the training of scientists and engineers in those disciplines comprising the atmospheric and earth sciences.....	16
Summary.....	17
<b>II. Background Information on the Cooperative Institute for Meteorological Satellite Studies (CIMSS)</b> .....	<b>18</b>
1. Description of CIMSS, including research themes, vision statement and NOAA research collaborations.....	18
2. CIMSS Management and Administration.....	20
3. Summary of NOAA Funding to CIMSS in FY2015.....	20
<b>III. Project Reports</b> .....	<b>24</b>
1. CIMSS Task 1A Support – Administration.....	24
2. CIMSS Task 1B Support – Education and Outreach.....	25
3. CIMSS Participation in the Product Systems Development and Implementation (PSDI) for 2015.....	28
3.1 Polar PSDI: Transition of MODIS and AVHRR Winds to GOES-R/VIIRS Algorithm.....	28
3.2 An Enterprise Processing System for Polar (CLAVR-x) Products.....	29
3.3 Polar PSDI: Enterprise Processing Ground System – Volcanic Ash Products.....	30
3.4 GEO PSDI: An Enterprise Processing System for Geostationary (GSIP).....	31
3.5 GEO PSDI: Enterprise Processing Ground System – Fog and Low Cloud Products.....	34
4. CIMSS Participation in the GOES-R Algorithm Working Group (AWG) for 2015-2016.....	35
4.1 Proxy Data Support.....	35
4.2 GOES-R Analysis Facility Instrument for Impacts on Requirements (GRAFIIR).....	37
4.3 Algorithm Integration Team Technical Support.....	39
4.4 GOES-R Collocation.....	41
4.5 ABI Cloud Products.....	43
4.6 Active Fire/Hot Spot Characterization.....	49
4.7 GOES-R Legacy Atmospheric Profile, Total Precipitable Water (TPW) and Atmospheric Instability Indices.....	52
4.8 ABI Derived Motion Winds.....	56
4.9 Hurricane Intensity Estimation (HIE) Algorithm.....	57
4.10 Volcanic Ash.....	59
4.11 Imagery and Visualization.....	61
4.12 Estimate of Fractional Snow Cover with ABI.....	65
5. CIMSS Participation in the GOES-R Future Capabilities for 2015-2016.....	67
5.1 GOES-R Future Capability: Development of the GOES-R Tropical Overshooting Top (TOT) Product.....	67
5.2 GOES-R Future Capability: Continued Development of the GOES-R AWG Fog/Low Cloud Products.....	69
5.3 Infrastructure – RGB Products in AWIPS II.....	73



5.4 Convective Initiation and 0-6 Hour Storm Nowcasting for GOES-R.....	74
6. CIMSS GOES-R Risk Reduction Program 2015-2016 .....	75
6.1 Towards Providing Forecasters with Better Identification and Analysis of Severe PyroConvection Events using GOES-R ABI and GLM Data .....	75
6.2 Applications of Concurrent Super Rapid Sampling from GOES-14 SRSOR, Radar and Lightning Data .....	79
6.3 Development and Optimization of Mesoscale Atmospheric Motion Vectors (AMVs) using Novel GOES-R Processing Algorithms on 1-5 min. SRSO Proxy Data, and Demonstration of Readiness for GOES-R Applications via Impact Studies in Mesoscale Data Assimilation and NWP Systems .....	81
6.4 Development of a Near Real-time Satellite Verification and Forecaster Guidance System for the High-Resolution Rapid Refresh (HRRR) Model .....	83
6.5 Development of Realtime All-weather Layer Precipitable Water Products in AWIPS II by Fusing the GOES-R and NWP for Local Forecasters.....	86
6.6 Using Multi-Sensor Observations for Volcanic Cloud Detection, Characterization, and Improved Dispersion Modeling.....	89
6.7 Assimilation and Forecast Impact of High Temporal Resolution Leo/Geo AMVs in the High-Latitude Data-Gap Corridor .....	92
6.8 Probabilistic Forecasting of Severe Convection through Data Fusion.....	95
6.9a Development and Demonstration of a Coupled GOES-R Legacy Sounding NearCast with Convective Initiation Products to Improve Convective Weather Nowcasts .....	98
6.9b Preparing the CIMSS NearCast system for Transition from Research to Operations (R2O).....	100
6.10 Transitioning the NASA Aircraft Icing Threat Capability to NOAA Operations...	102
7. CIMSS Participation in the Development of GOES-R Proving Ground in 2015-2016.....	103
8. CIMSS High Impact Weather Studies with GOES-R and Advanced IR Sounder Measurements .....	111
9. Investigations in Support of the GOES-R Program .....	116
9.1 Ongoing Support .....	116
9.2 McIDAS-V Support for GOES-R Development.....	118
10. Implementing the GOES-R Future Capability Ice Products into the GOES-R Processing System .....	120
11. GOES-R Future Capability: SO <sub>2</sub> Detection .....	122
12. Identification of GOES-R Storm Top Features.....	124
13. Development of a Geostationary Community Satellite Processing Package (CSPP).....	129
14. GOES-R Specific Mobile Apps .....	134
15. Implementing the GOES-R Future Capability Cloud Cover Layer Product into the GOES- R Processing.....	136
16. SSEC/CIMSS Cloud Research in Support of the Suomi-NPP and JPSS Programs .....	137
16.1 VIIRS Cloud Mask Validation and Tool Development .....	137
16.2 Cloud Phase Algorithm .....	139
16.3 Cloud Optical Properties Algorithm.....	141
16.4 Cloud Top Properties Algorithm.....	143
16.5 CSPP Support .....	145
16.6 VIIRS Aerosol Evaluation Using Satellite Observations.....	148
16.7 McIDAS Support for VIIRS Imagery and Data Analysis.....	149
17. SSEC/CIMSS Research Tasks in Support of the Suomi NPP and Joint Polar Satellite System (JPSS) Sensor Data Records.....	151
17.1 A Broad Scope of Calibration/Validation and Independent Verification and Validation Activities in Support of JPSS, with Emphasis on CrIS SDRs.....	151



17.2 VIIRS SDR Calibration/Validation.....	154
18. SSEC/CIMSS Research Tasks in Support of Suomi NPP and the Joint Polar Satellite System (JPSS) Sounding and Cryosphere Environmental Data Records (EDR) .....	157
18.1 CrIMSS EDR Cal/Val: ARM Site Support 2015 .....	157
18.2 Science and Management Support for NPP VIIRS Snow and Ice EDRs in 2015 ..	160
19. JPSS Risk Reduction Algorithm Integration Team Midwest .....	163
20. CIMSS Participation in the JPSS Proving Ground/Risk Reduction Program for 2015 .....	164
20.1 Advancing Hyperspectral Sounder Applications in the Direct-Broadcast Environment .....	164
20.2 Enhance the Utilization of Real Time JPSS Sounder Data in SDAT for Tropical Cyclone Forecast Application .....	167
20.3 High Resolution Trajectory-Based Smoke Forecasts using VIIRS Aerosol Optical Depth and NUCAPS Carbon Monoxide Retrievals .....	173
20.4 JPSS Cloud Cover Layers Development.....	177
21. CIMSS Participation in the 2015 JPSS Directed Risk Reduction Program.....	178
21.1 Improving Very Short Range Forecasts for the NWS Alaska Region Using Objective Tools Designed to Optimize the Retention of Hyperspectral Infrared and Microwave Moisture LEO Soundings.....	178
21.2 Ongoing Investigations in Support of the JPSS Program.....	181
22. CIMSS Participation in the JPSS Risk Reduction Program for 2016.....	183
22.1 Application of JPSS Imagers and Sounders to Tropical Cyclone Track and Intensity Forecasting .....	183
22.2 Strengthening TPW Visualization in the OCONUS Domain with JPSS Data Products .....	185
23. Polar Satellite Antenna for the National Weather Service in Guam.....	187
24. The Development of the High Performance JPSS Analysis Facility for Instrument Impacts on Requirements (JAFIIR).....	189
25. The Development of a Community Satellite Processing Package (CSPP) in Support of Suomi NPP/JPSS Real Time regional (RTR) Applications for 2015 .....	193
25.1 The Development of a Community Satellite Processing Package (CSPP) in Support of Suomi NPP/JPSS for 2015 .....	193
25.2 Improving Access to Full Resolution VIIRS Imagery in AWIPS.....	195
25.3 GOES-R Support for International TOVS Study Conference (ITSC-20) .....	197
25.4 Assessing the Impact of Assimilating Clear and Cloudy Sky CrIS Radiances in a Regional-scale Ensemble Data Assimilation System.....	199
25.5 JPSS Support for Direct Readout Site at University of Puerto Rico-Mayaguez.....	200
25.6 The Development of ISEE: An “Innovative Satellite Enhancement Exploration” ..	202
25.7 Incorporating the GMU Flood and CCNY Ice Products Algorithms into the CSPP205	
26. SSEC/CIMSS Participation on the Algorithm Development Library (ADL) Team.....	208
27. CIMSS Visiting Scientist on Tropical Cyclone Monitoring and Predicting with Satellite Measurements .....	211
28. Implementation of GCOM-W1 AMSR2 Snow Products.....	214
29. CIMSS Participation in VIIRS Cloud Products Using DNB the JPSS Risk Reduction Program for 2014 .....	217
30. Support CIMSS JPSS and AWIPS II OCONUS Satellite Liaison .....	219
31. JPSS Ground Project Field Terminal Node Support 2015.....	221
32. CIMSS Participation in Upgrade and Extension of NOAA’s OSSE Capabilities .....	223
33. Radiance and Retrieval Simulation for NSSL Regional OSSE .....	226
34. Support for NPP and JPSS Data Assimilation Improvements and Data Denial Experiments .....	228



35. CIMSS Cal/Val Activities in Support of the Calibration Work Group .....	230
36. Support for Improving the Use of Air Borne Observations (ABO) in Daily Forecasting within NOAA NWS .....	232
37. CIMSS End of Year Research Task Proposal .....	234
37.1 Real-time Monitoring of Lightning Detection Network Performance .....	234
37.2 EOY Funding: Filling the Gaps in the HIRS Cloud and Moisture Reprocessing ...	236
37.3 Creation and Validation of a Climatology of CAPE and CIN in the U.S. East of the Rockies from JPSS and METOP Polar Sounders .....	242
37.4 Stratospheric Warming and Tropospheric Cold Pool Studies Using NUCAPS/AIRS and GPS RO .....	245
38. CIMSS Participation in Sensing Hazards with Operational Unmanned Technology (SHOUT).....	249
39. Support for the NOAA Cloud Climate Data Records .....	250
40. CIMSS support for Aura Chemical Reanalysis in Support of Air Quality Applications (NASA) .....	252
41. CIMSS Participation in SHyMet for 2015 .....	255
42. CIMSS Collaboration with the NWS Operations Proving Ground .....	256
43. CIMSS Collaboration with the Aviation Weather Center.....	258
44. GOES-R Education Proving Ground .....	260
45. Project ABI Short Courses (CIMSS Support to GOES-R Program) .....	262
46. Development and Delivery of Himawari Training Workshop for NWS Forecast Office in Guam .....	264
47. CIMSS Research Activities in the VISIT Program for 2015 .....	266
<b>Appendix 1: List of Awards to Staff Members .....</b>	<b>269</b>
<b>Appendix 2: Publications Summary .....</b>	<b>271</b>
<b>Appendix 3: Employee Support Documentation .....</b>	<b>273</b>
<b>Appendix 4: Research Topics of Current CIMSS Graduate Students and Post-Doctors ...</b>	<b>274</b>
<b>Appendix 5: Visitors at CIMSS 2015-2016 (visits of 3 days or more and key visitors) .....</b>	<b>279</b>
<b>Appendix 6: List of Staff/Students hired by NOAA in the past years .....</b>	<b>281</b>
<b>Appendix 7: CIMSS Board of Directors and Science Council .....</b>	<b>282</b>
<b>Appendix 8: CIMSS Publications, 2013-2016 .....</b>	<b>283</b>



## Figures

Figure 1. Left to Right: Steve Bruske (NWS), Bill Curtis (UW-Madison EM), Tim Halbach (NWS), Louis Uccellini (NWS), UW-Madison Chancellor Rebecca Blank, Steve Ackerman (CIMSS & AOS), Margaret Mooney (CIMSS), Shane Hubbard(CIMSS) <i>Photo Credit: Bill Bellon (SSEC)</i> .....	26
Figure 2. GOES-R Educators .....	27
Figure 3. Example GSIP product output. ....	33
Figure 4. Initial output of the GOES-R FLS products produced by the AIT framework. The values of the LIFR probability (top left), IFR probability (top right), MVFR probability (bottom left) and fog depth (bottom right) products all fall within expected ranges in both magnitude and geographic location indicating the initial implementation of the GOES-R FLS algorithm appears to have been successful.....	35
Figure 5. McIDAS-V image at 1900 UTC 2 Oct 2015 from WRF-Chem/CRTM-simulated ABI data at WRF-Chem model resolution. ....	37
Figure 6. A list of all ABI waivers addressed by the GRAFIIR program through 2015.....	39
Figure 7. The enterprise GOES-R cloud top height applied to AHI observations is presented in the top figure. Collocated CALIPSO inter-comparisons are presented at the bottom of the image. The white dots in the CALIOP attenuated backscatter profile (bottom left) are the collocated GOES-R cloud top results. The bottom right figure presents the distribution of cloud top height differences between CALIOP and AHI.....	43
Figure 8. Post hurricane analysis of category 4 Hurricane Earl comparing ACHA cloud heights with CALIPSO. ACHA cloud heights match CALIPSO well in the convective eyewall and outer band. ....	45
Figure 9. Example AHI true color RGB over the KORUS-AQ domain from April 12, 2016 at 0330 UTC. This is just one of several products supplied by the Cloud AWG team.....	46
Figure 10. FDCA fire detections from Himawari-8 AHI data over Sumatra at 3:20 UTC on 24 September 2015 overlaid on MODIS Aqua imagery and fire data from 3:15 UTC. MODIS fires are red polygons, FDCA fires are red, magenta, and cyan colored targets. The two instruments agree well. This data was created before the bug affecting detections was fixed.....	52
Figure 11. One example of TPW from AHI (upper left), the retrieval flag (clear retrievals, cloudy retrievals and GFS) (upper right panel), along with the scatterplot between AHI and ECMWF TPWs at 00 UTC on 06 July 2015. ....	54
Figure 12. An example of region-based plotting over GOES-13 regions: the TPW (hourly) comparison to GPS measurements on 07 September 2015. The standard deviation (STD) is in the upper panel, the bias is in the middle panel and the RMS is in lower panel. ....	55
Figure 13. Comparisons between ADT intensity analyses using A) MTSAT (red line) and Himawari-8 (green line) imagery and B) Himawari-8 30-minute (red line) and 10-minute (green line) imagery for Tropical Cyclone 17W. The JTWC best track intensity is provided for comparison (black line). ....	58
Figure 14. The Himawari-8 derived ash detection and ash cloud height products are validated using CALIOP measurements. The above figures show that the Himawari-8 products agree well with the space-based lidar measurements taken at 06:05 UTC on November 4, 2015. The GOES-R AWG validation tools were used to generate this analysis.....	61
Figure 15. A 16 panel CONUS "First Light Imagery" mock up generated using a combination of McIDAS-V scripting and ImageMagick. Data are proxy ABI simulated for August 20, 2015 at 20:00 UTC. ....	64





Figure 16. GOES -R ABI Level 2 snow cover on June 19, 2015 using proxy data during the data operations exercise 1 and 2 ..... 66

Figure 17. Results of a yes-no forecast for tropical cyclone (TC) rapid intensification (RI) for the single-predictor TOT RI Index (blue), multi-predictor Rapid Intensification Index (RII; red) and combined (black). Overall, all methods are skilful at predicting TC RI, as indicated by the positive Peirce Skill Score (PSS). The multi-predictor RII is more skilful than the TOT RI Index, but adding the TOTs to the RII increases the RII skill. .... 68

Figure 18. Probability of detection (POD), false alarm ratio (FAR), probability of false detection (POFD), and Heidke Skill Score (HSS) for TOT prediction of TC genesis. Positive HSS indicates the forecast for each timeframe is skilful. .... 69

Figure 19. The end result of blending the GOES-West IFR probability product with VIIRS and the "valleyness" metric, which is derived from digital elevation model, is shown in the bottom figure for a scene near Anchorage, AK. The course resolution GOES-West IFR probability product is effectively down-scaled to the resolution of the VIIRS product. The information content of the VIIRS image is maintained for many GOES images through use of the digital elevation model and temporal consistency. .... 72

Figure 20. The left panel shows the large fire hot spot along with smoke from the fire. The right panel shows the growing pyroCb tower in the visible reflectance image. .... 78

Figure 21. GOES-14 Visible image from May 21, 2014 (21:31 UTC) with accumulated lightning counts (upper left), TDWR radar (upper right), IR brightness temperatures in a "sandwich product" display (lower left), and satellite derived winds (lower right). .... 81

Figure 22. Forecast impact experiments with the RAP model for two selected severe weather cases (flooding event in Texas, and EF-3 tornado event in Colorado, both in May-June 2015) were conducted with assimilation of the heritage mesoscale AMVs (Benchmark dataset) and compared with a control run (without assimilation). Selected results from RAP analyses are shown above. .... 83

Figure 23. (top panels) Simulated and observed GOES 10.7  $\mu\text{m}$  brightness temperatures valid at 07 UTC on 18 July 2015. The simulated brightness temperatures are from a 6-hour HRRR model forecast starting at 01 UTC on 18 July 2015. (bottom panels) Cloud objects identified by MODE using the simulated and observed brightness temperatures. Matching cloud objects in the forecast and observations are encircled by thick black lines. A brightness temperature threshold of 250 K and a convolution radius of 15 km (five model grid points) were used to identify the cloud objects. The GOES brightness temperatures were remapped to the HRRR model projection prior to running MODE. .... 85

Figure 24. Example of TPW retrieval from INSAT-3D at 01 UTC on 05 June 2015. The left panel shows TPW retrievals in mm. The right panel shows the clear/cloudy flags for retrievals. .... 88

Figure 25. A screenshot of a near-realtime VOLCAT ash alert associated with an eruption of Fuego (Guatemala) on January 20, 2016 is shown in the top panel. The Washington VAAC utilized this alert to issue a Volcanic Ash Advisory (bottom, left panel). A more detailed view of the ash detected by VOLCAT is shown in the bottom, right panel. The VOLCAT products provided unique information, as the Fuego ash cloud was not unambiguously identifiable in the standard satellite products utilized by the Washington VAAC. .... 91

Figure 26. Mean 500 hPa geopotential height anomaly correlation scores for LEO/GEO experiments from (left) 01 April 2014 – 30 May 2014 and (right) 01 December 2014 – 06 February 2015, for the (top) northern hemisphere and (bottom) southern hemisphere. All four panels show in the top half the mean correlation die-off curve for the control in black and the experiment in red, and in the bottom half the difference (experiment minus



control) with bars representing the minimum difference required for 95% statistical significance..... 94

Figure 27. Mean 500 hPa wind speed bias scores for LEO/GEO experiments from (left) 01 April 2014 – 30 May 2014 and (right) 01 December 2014 – 06 February 2015, for the (top) northern hemisphere and (bottom) southern hemisphere. All four panels show in the top half the mean correlation die-off curve for the control in black and the experiment in red, and in the bottom half the difference (experiment minus control) with bars representing the minimum difference required for 95% statistical significance..... 95

Figure 28. This storm in northeast Oklahoma (March 30, 2016) produced large hail and several EF-2 tornadoes. The predictors in the ProbSevere model combined to assign a probability of 95% well before the first severe thunderstorm warning was issued (see <http://www.goesrhwt.blogspot.com/2016/03/tulsa-claremore-ok-tornado.html>)..... 97

Figure 29. Fused GOES-R Legacy Sounding NearCast and Convective Initiation Product display showing NearCast 2 h forecast of low-level equivalent potential temperature tendency valid at 2000 UTC 19 May 2015 with overlaid CI nowcasts valid at 2015 UTC 19 May 2015. .... 99

Figure 30. Model and assimilation configurations (left), model domain and storm evolution from radar (right) for a derecho case on 30 June 2012. .... 113

Figure 31. The ETS scores from GTS (blue) and GTS+LPW (PW\_HL) (red) are shown in the upper left panel. The 6-hour cumulative precipitation forecasts from assimilating GTS and GTS+PW\_HL are shown in the right two panels, the observations are shown in the lower left panel. .... 115

Figure 32. Wind parcel trajectories on 850mb during hurricane Sandy and colored by speed.... 119

Figure 33. Wind parcel trajectories depicted as shaded cylinders (for better depth perception) computed in a RAPS 3D domain. .... 120

Figure 34. Ice surface temperature and ice concentration using ice algorithm developed for GOES-R ABI with Himawari-8 AHI data as input on March 27, 2015..... 122

Figure 35. Example image from SO<sub>2</sub> alert that will be produced by VOLCAT, with SO<sub>2</sub> cloud annotated in blue..... 124

Figure 36. Examples of cold-U shaped storms — top (Meteosat-9, 26 May 2007, 15:00 UTC, Germany) and cold-ring shaped storms — bottom (Meteosat-8, 25 June 2006, 13:45 UTC, Czech Republic and Austria). Left: high resolution visible (HRV) images, right: color enhanced IR10.8 images. Legend: 1—overshooting tops, 2—cold-U shape, 3—cold ring shapes, 4—close-in warm area (CWA), 5—distant warm area (DWA), 6—central warm spots (CWS). Both cases are shown in the same scale and enhancement. Time labels in this figure refer to the beginning of the scan of the image slot. .... 126

Figure 37. WISCDYMM model simulations. a. (left): Cloud top temperature field of the simulated CCOPE supercell at t=7200 sec. b. (right): Cloud top temperature field of the simulated storm at t=1800 sec using the idealized soundings. The cloud top in both figures is represented by the 90% RH<sub>i</sub> iso-surface, temperature scales are identical. Spatial orientation with respect to the model grid and horizontal scales are indicated in lower right corners of each image; please note that the horizontal scales differ for the two images. .... 127

Figure 38. Simulated storm top temperature of the shear-less CCOPE supercell showing a symmetric cold ring (red) at the storm top. Inside the ring is a warm area (blue). The cold ring appears in the early stage of the storm. .... 128

Figure 39. Simulated storm top temperature of the shear-less CCOPE supercell at a later stage showing a symmetric cold ring (orange) larger than that in Figure 38 and a generally cold area in the center with a warm “pancake cloud” appearing on top of the cold patch. The



pancake cloud appears to be produced by the Rayleigh-Taylor instability at the storm top. .... 129

Figure 40. CSPP Geo data flow diagram showing current and future software packages and processing chains..... 131

Figure 41. Quicklook image from the CSPP Geo GEOCAT package, show Cloud Optical Depth ..... 134

Figure 42. Screenshots from the new prototype “RealEarth” app that provides access to all 450+ RealEarth satellite imagery and related data products. The left image shows an RGB Himiware8 composite, the middle image show the top portion of the RealEarth product selector and the right image shows some of the interface options. The app supports customizable animation. .... 135

Figure 43. The brown colors represent clouds from the surface to 642 hPa. The green colors are from 642 – 350 hPa, and the blue are clouds from 350 hPa to the top of atmosphere.... 137

Figure 44. a) Global False Color RGB and b) Global VCM performance, 16 April, 2016, Ascending node. .... 139

Figure 45. VCM – CALIPSO performance time series over 60N-60S, Land, Day, No Snow/Ice, COD  $\geq$  0.3. .... 139

Figure 46. Cloud phase and type output for a VIIRS granule over Asia on November 10, 2012 at 03:39 UTC. False color images are in top two panels and the cloud phase (left) and type (right) are in bottom two panels. CALIPSO ground track is overlaid on each panel..... 141

Figure 47. Cover pages of ATBD and OAD for DCOMP retrieval. .... 143

Figure 48. Comparison of the cloud optical depth retrievals. Upper two panels compare ACHA to CALIPSO using the aggregate column and empirical models, respectively. Bottom two panels compare ACHA to MODIS Collection 6 products using the same models. .... 145

Figure 49. a) Cloud Type; b) Cloud Top Temperature (CTT); c) Cloud Top Height (CTH), CSPP CLAVR-x, NOAA19, June 09, 2015, 09:04UTC. .... 147

Figure 50. VIIRS True Color Image from NASA L1B data rendered in McIDAS-V. .... 150

Figure 51. Time series of SNPP VIIRS – CrIS daily comparisons (left) and VIIRS SNO comparisons to MetOp-A IASI (right). .... 156

Figure 52. CrIMSS EDR radiosonde launch efforts July 2012 – March 2016..... 159

Figure 53. Comparison of ARM BE radiosonde, COSMIC RO, and NUCAPS temperature profiles (left) and differences (right) at NSA on 14August2014..... 159

Figure 54. Comparison of ARM routine radiosondes, COSMIC RO, and NUCAPS temperature profiles at NSA, May 2012 – April 2015: number of samples (left), temperature differences on 100 levels (middle), and temperature differences on 1km layers (right). Bias (solid) & RMS (dashed). .... 160

Figure 55. Histogram of ice surface temperature differences between NPP VIIRS and MODIS (Aqua and Terra) in the Arctic only from August 2012 to July 2015 for cases with MODIS ice surface temperature in the ranges 213-230 K, 230-240 K, 240-250 K, 250-260 K, 260-270 K, and 270-275 K. Measurement bias and RMSE<sub>nobias</sub> are indicated for each bin..... 162

Figure 56. CrIS BT at 910 cm<sup>-1</sup> (left panels, top and bottom show cloud-cleared and original BT, respectively), retrieved temperature and relative humidity (RH) at the 700 hPa pressure level and cloud top pressure (CTOP), derived with NUCAPS (top) and UW Dual-Regression (bottom). .... 166

Figure 57. Forecast RMSE for Sandy (2012) track (upper), central sea level pressure (middle) and maximum wind speed (lower). .... 169

Figure 58. The track RMSR from different experiments. .... 170



Figure 59. The hurricane Joaquin (2015) 120-hour forecasts started at 00 UTC, 06 UTC, 12 UTC and 18 UTC on 01 October 2015 from SDAT (blue) and other operational models, along with the best track (black). ..... 171

Figure 60. IDEA-I VIIRS AOD forecast for August 20, 2015 showing the VIIRS AOD on August 20, 2015 used for initializing the trajectories (upper left), the 48hr trajectory forecast valid at 19Z on August 22, 2015 (upper right), the VIIRS AOD on August 22, 2015 used to verify the trajectory forecast (lower left) and surface PM2.5 measurements (black) and RAQMS model PM2.5 predictions (red) at Wind Cave, SD (lower right). ..... 175

Figure 61. RealEarth visualization of VIIRS AOD retrieval (colored), VIIRS fire detection (red points), and HMS analysed smoke (light green objects) for March 28, 2016 and zoom over NE OK and SE KS. .... 176

Figure 62. Comparison of NearCast Analyses of 200 hPa temperature over Alaska using CrIS and IASI retrievals using NUCAPS and EUMETSAT retrieval systems. All retrievals analyzed onto grid comparable to mean NUCAPS retrieval footprint size (based on microwave FOV size), thereby smoothing some details present in IR-FOV sized IASI data. .... 180

Figure 63. Comparisons results for 19 January 2009. (left) HIRS CTPs (in hPa) using CO2 slicing for ice and IRW for water clouds. (right) Difference HIRS minus HIRS-IASI CTPs (in hPa). ..... 182

Figure 64. Morphological composite of TPW from SNPP ATMS, POES/Metop AMSU/MHS and DMSP SSMIS using the MIRS retrieval. .... 187

Figure 65. Layout of detectors for current and next generation CrIS. .... 191

Figure 66. Simulated brightness temperatures using the orbit simulator to generate satellite geometry information for S-NPP CrIS channel 482 (CO<sub>2</sub>). ..... 191

Figure 67. Progress of various components of the OSSE as of March 2016. .... 192

Figure 68. VIIRS M-Band 11 (2.25 micron) reflectance full resolution (740 m) image as displayed in AWIPS-II. The image was created using direct broadcast data acquired and processed at UW-Madison/CIMSS/SSEC using modified VIIRS Imagery EDR software. This band is currently not produced by the operational Imagery EDR software, and is therefore not available to forecasters using the AWIPS-II plug-in at this time. It is useful for snow and ice discrimination as well as cloud microphysical property identification. .... 197

Figure 69. RealEarth browser display of daily S-NPP VIIRS True Color Composite with VIIRS Satellite Detected Fire Locations (newest available) from VIIRS Active Fire team at University of Maryland (<http://viirsfire.geog.umd.edu/>). ..... 203

Figure 70. ISEE iOS Prototype App display of daily S-NPP VIIRS True Color Composite with VIIRS Satellite Detected Fire Locations (newest available) from VIIRS Active Fire team at University of Maryland (<http://viirsfire.geog.umd.edu/>). This is an actual screenshot from an iPhone 5s. .... 205

Figure 71. Example of the flood product for 13 April 2016 at 1959 UTC for the Missouri River. The majority of the river is open water (blue); shades of red indicate potential flooding areas. .... 207

Figure 72. Example of flood notification tool in RealEarth used to define conditions that will generate email notifications. .... 207

Figure 73. SSEC ADL Website showing ADL installation instructions. .... 210

Figure 74. SSEC Forum for ADL. .... 211

Figure 75. IR image at 04 UTC (upper left), GPM rainrate measurements at 06 UTC (upper right) on 07 July 2014 for Typhoon Neoguri. Track (lower left) and central sea level pressure (SLP) forecast RMSE from 06 UTC 04 July valid to 00 UTC 06 July, 2014. Eight groups of forecasts (updated every 6 hours) are included in the statistics. .... 213



Figure 76. The track RMSEs of Typhoon Neoguri (2014) forecasts from assimilation of ATMS radiances with VIIRS cloud detection (COT<5) (green line), ATMS and CrIS radiances with VIIRS cloud detection (blue line), and ATMS and CrIS radiances with GSI cloud detection (red line), respectively. ....214

Figure 77. NLCOMP cloud products and provisional rain rate retrieval from VIIRS Day/Night Band Lunar reflectance (left) and MIRS ATMS microwave based passive (right) for 10th October 2014 for two night orbits. ....218

Figure 78. Impact of GEO AIRS on Hurricane Sandy track forecast versus that of LEO AIRS. Notice the overall improvement by GEO AIRS over the whole forecast period. The black line is the forecast ceiling of thr track error from assimilating the NR. Note how the GEO AIRS is approaching the forecast ceiling (72.45 km). ....224

Figure 79. Impact of high temporal resolution from GEO AIRS on Hurricane Sandy track forecast. Notice that more frequent assimilaition leads to better track forecast: 1hcyc > 3hcyc > 6hcyc > noncyc. ....225

Figure 80. The standard deviation error of the synthetic sounding retrievals from the GEO AIRS of a) temperature and b) moisture. ....227

Figure 81. AHI 16 panel from November 12, 2015 at 21:20 UTC showing a major anomaly occurred to affect data. This turned out to be an issue with the cryo-cooler. ....232

Figure 82. Locations of routine radiosonde launch sites (red), WVSS-visited airports within 50 km of a radiosonde (blue), and other WVSS-visited airports (green). The close proximity of radiosondes to aircraft profiles at the blue sites makes them ideal for intercomparing the two instruments. ....234

Figure 83. A smoothed representation of ENI total lightning flash density (units of flashes min<sup>-1</sup> km<sup>2</sup>). This field was extracted from within the bounds of radar-identified and tracked storm objects, and used to train n. ....236

Figure 84. Percentage of HIRS observations that found high clouds in the northern hemisphere 0° to 60°N from 1980 to 2015. ....238

Figure 85. Percentage of HIRS observations that found high clouds in the southern hemisphere 0° to 60°S from 1980 to 2015. ....239

Figure 86. HIRS observations of TPW in the northern hemisphere 0° to 60°N from 1980 to 2015. ....240

Figure 87. HIRS observations of TPW in the southern hemisphere 0° to 60°S from 1980 to 2015. ....241

Figure 88. The MODIS satellite image above was taken 4.5 hours before the El Reno event on May 31, 2013. The right panel shows the CAPE value detected by AIRS at the same time. El Reno/Norman Oklahoma is shown as a white dot and the SGP ARM site as a star. (from Gartzke et al. 2015, <https://ams.confex.com/ams/27SLS/webprogram/Paper255450.html>) ....244

Figure 89. Seasonal variation in dewpoint (left top) and surface CAPE (left bottom) at the ARM SGP site. The right panel is the distribution of CAPE values for AIRS, ERA, and Sonde showing a 10% reduction in CAPE due to lower vertical resolution of the IR sounder profiles. ....244

Figure 90. AIRS vs. ARM radiosonde all data with AIRS cloud fraction less than 0.8 (left) and a subset with surface dew point within one degree (right). This implies that the large scatter in the AIRS CAPE is due to errors in the estimate of the surface dewpoint temperature using in the CAPE parcel. ....244

Figure 91. Left panel shows a vertical cross-section of the polar vortex at 67.5 deg N as measured by COSMIC and AIRS. Right panel is an example showing how the higher vertical resolution of the COSMIC data can be used to determine the precise lower boundary of the cold air aloft. Overlaid temperature profiles from an example COSMIC (red), AIRS



(blue), NWS sonde (solid black), and ARM sonde (dashed black) matchup over the Barrow, AK ARM site on 24 Feb 2014.....247

Figure 92. (left) Spatial coverage of the two GPS RO systems considered in this study. (right) A bar graph of the daily average number of profiles from COSMIC and METOP-A GRAS for each AK Standard Time hour over the month of January 2014 for the AK region defined by red boxes in Fig 7. NWS 00Z and 12Z radiosonde launch times are marked by green circles. (Right) Subjective evaluation of various measurement systems contributions to cold air aloft over the Alaska region. ....247

Figure 93. (Left) Overlaid GFS-COSMIC and GFS-NUCAPS monthly and daily averaged temperature biases for 60°N-90°N at 3 different pressure levels showing seasonal biases in the NUCAPS product relative to both GFS and GPS RO. (Right) Subjective evaluation of various measurement systems contributions to cold air aloft over the Alaska region. ....248

Figure 94. Mean cloud fraction difference for the entire NOAA-19 PATMOS-x record calculated as IFF (AVHRR + HIRS) minus GAC (AVHRR-only).....251

Figure 95. July 2010 Tropospheric NO<sub>2</sub> Column (10\*\*15 mol/cm<sup>2</sup>) from the RAQMS/GSI Aura Reanalysis. White contours show mean sea level pressure. ....254

Figure 96. Change in July 2010 Tropospheric Ozone Column (DU) (assimilation-control) within the RAQMS/GSI Aura Reanalysis due to assimilation of OMI TNO<sub>2</sub> retrievals. Blue contours show mean sea level pressure. ....254

Figure 97. Discussion of satellite related icing products at the non-convective CAWS product desk during the AWT Winter Experiment 2016.....260

Figure 98. GOES-R Educators. ....261

Figure 99. Dr. Marshall Shepherd delivering the lunch-time presentation at the GOES-R/JPSS AMS Short Course in New Orleans. ....264



## I. Director's Executive Summary

Since its formation in 1980, the University of Wisconsin–Madison (UW–Madison) Cooperative Institute for Meteorological Satellite Studies (CIMSS) has built a strong collaborative partnership with the National Oceanic and Atmospheric Administration (NOAA). This partnership provides outstanding benefits to the atmospheric science community and to the nation through improved use of remote sensing measurements for weather prediction, climate analysis and monitoring environmental conditions. Under the auspices of CIMSS, scientists from NOAA/NESDIS and the UW–Madison Space Science and Engineering Center (SSEC) have a formal basis for ongoing collaborative research and education efforts. In particular, CIMSS scientists work closely with the NOAA/NESDIS Advanced Satellite Product Branch (ASPB) stationed at the UW–Madison campus. This collaboration includes a scientist from the National Climate Data Center (NCDC), who joined the NOAA NESDIS employees stationed at CIMSS.

This annual report demonstrates that CIMSS continues to excel at meeting the three components of its mission statement. We will briefly describe examples relevant to NOAA that demonstrate how CIMSS personnel, in collaboration with ASPB and others, are meeting our mission goals. Details on individual projects are provided later in the report; here we only refer to a few relevant examples.

### **1. Foster collaborative research between NOAA and UW–Madison in those aspects of atmospheric and earth science that exploit the use of satellite technology.**

One metric of success in fostering collaborative research is to quantify the number of collaborative publications in general, and those with NOAA employees in particular. CIMSS continues to publish more than 40% of its peer reviewed papers with NOAA co-authors (see Appendix 2), indicating the strong collaborations between the two organizations. CIMSS scientists work with NOAA NESDIS ASPB scientists in support of the quality-assurance of the current and future GOES, Suomi NPP and JPSS observations.

Another assessment strategy that CIMSS is meeting its goals is our ability to work with NOAA in transferring research to NOAA operations. In preparation for the GOES-R era, CIMSS developing many of the GOES-R algorithms, including cloud properties, atmospheric motion vectors, volcanic ash and SO<sub>2</sub>, hurricane intensity, fire and hot spots, fog and low clouds. Preparing forecasters for new data analysis methods is also a goal of CIMSS. In preparation for the GOES-R launch, proxy data capabilities with real-time synthetic Cloud and Moisture Imagery (CMI) that includes effects of clouds, water vapor, aerosols and ozone as well as realistic treatment of surface emissivity and reflectivity for all 16 ABI bands. The Clouds from AVHRR Extended (CLAVR-x) has been the operational NESDIS cloud processing system for the Advanced Very High Resolution Radiometer (AVHRR) for over 10 years. The CLAVR-x algorithm is a collaborative effort between ASPB and CIMSS scientists, and output from this program is currently being used by NCEP for NWP verification as well as the IASI processing at ESPC. In addition, CLAVR-x is used as input for Cloud product composites over Alaska. In response to a request from the Washington Volcanic Ash Advisory Center (VAAC), a transition of the AVHRR derived volcanic ash products to NESDIS operations within the AIT Framework is being undertaken by CIMSS and ASPB.



CIMSS scientists collaborate with ASPB scientists in assessing new and current satellite instruments, continuing a tradition of over 35 years. The GOES-14 satellite was operated in Super Rapid Scan Operation for GOES-R (SRSOR) mode on several days during 2015 for the purpose of demonstrating the value of high temporal observations (1-minute intervals) from GOES which will become available regularly with GOES-R. Some of this data is being combined with radar and lightning observations for detailed studies of severe thunderstorms. As another example, an improved Atmospheric Motion Vector (AMV) product was developed for the GOES-R Advanced Baseline Imager (ABI) using a new tracking algorithm. This new tracking algorithm has been demonstrated to significantly improve the slow speed bias inherent in the AMVs derived from previous algorithms. This significant reduction in the speed bias of the AMVs could benefit Numerical Weather Prediction (NWP) by improving the analyses and the accuracy of NWP forecasts. NOAA's AWG utilizes the CIMSS developed GRAFIIR-based tool set to measure the effects of Government-specified waivers and deviations (perturbations to instrument capabilities or functionality) on ABI Level 1B data and L2+ products.

CIMSS also has a long collaboration with NOAA scientist in conducting research and developing applications with NOAA's polar orbiting platforms. NOAA and NASA support several CIMSS projects that make use of instruments on the Suomi NPP platform. There are many activities, as described in the following sections, where NOAA support is provided to CIMSS researchers to support the JPSS program. JPSS risk-reduction activities seek to realize the full potential of VIIRS through innovative research and algorithm development. The notional beneficiaries of this research are many-varied and include all downstream developers of EDRs reliant on accurate nighttime cloud masking, the operational end-users of these VIIRS EDR products (e.g., forecasters), the climate research making use of VIIRS information, distillers of this information in connection with IGPC, and ultimately policy makers. Monitoring of the cryosphere, and in particular Earth's snow cover, is among the primary applications of polar orbiting satellites. CIMSS, in collaboration with ASPB scientists assessing the suitability of heritage snow algorithms, algorithm selection/implementation with AMSR2 data.

## **2. Serve as a center at which scientists and engineers working on problems of mutual interest may focus on satellite related research in atmospheric studies and earth science.**

CIMSS and ASPB scientists have strong national and international reputations for quality and collaborative work, which enables us to be a center of excellence in the general field of satellite remote sensing. Examples supporting this statement follow and are more fully documented in the research summary overviews.

With NOAA, CIMSS/SSEC endeavors to install and operate a direct broadcast satellite data reception station at the National Weather Service (NWS) office in Guam to (a) acquire real-time visible and infrared imagery, (b) serve imagery and related derived products to NWS meteorologists in Guam, (c) acquire and process infrared and microwave sounder data from polar-orbiting meteorological satellites, and (d) deliver the resulting products to NOAA with low latency for assimilation in numerical weather prediction (NWP) models. The reception system will include a polar satellite-tracking antenna capable of acquiring data via direct broadcast on X-band and L-band from operational satellites including, but not limited to, Suomi NPP, Metop-A/B, NOAA-18/19, and Terra/Aqua. A dedicated processing system at the Guam station will create Level 1B (Satellite Data Record) and Level 2 (Environmental Data Record) products automatically in real time.





CIMSS continues to support NOAA's objective of improved weather forecasting through data assimilation. We are working with personnel from the Atmospheric Infrared Sounder (AIRS) Science Team, the National Center for Environmental Prediction (NCEP), the National Environmental Satellite, Data and Information Service (NESDIS) and others in developing techniques to assimilate Suomi NPP CrIS, AIRS and the Infrared Atmospheric Sounding Interferometer (IASI) water vapor radiances. Observing System Experiments (OSEs) are used to quantify the contributions to the forecast made by SNPP/JPSS satellite data.

CIMSS is collaborating with the National Severe Storms Laboratory (NSSL) and the Cooperative Institute for Mesoscale Meteorological Studies (CIMMS) at the University of Oklahoma, on Observing System Simulation Experiments (OSSEs) to assess the potential for satellite observations to improve the characterization of storms within model analyses and forecasts.

Working closely with ASPB, CIMSS is producing high quality proxy ABI data sets derived from NWP model simulations. Synthetic ABI baseline products (including 16-band imagery) are generated in near-real-time over CONUS using the Joint Center for Satellite Data Assimilation (JCSDA) Community Radiative Transfer Model (CRTM) and model output from the WRF-Chem/RAQMS system.

UW–Madison has a long and positive reputation for satellite data distribution. Organizations throughout the world make use of the UW–Madison developed The Community Satellite Processing Package (CSPP), which supports the Direct Broadcast (DB) meteorological and environmental satellite community through the packaging and distribution of open source science software. CSPP supports DB users of both polar orbiting and geostationary satellite data processing and regional real-time applications through distribution of free open source software, and through training in local product applications. In addition to providing access to the data, the package also supports analysis and visualization. A particular focus is the newest release of NOAA-developed algorithms and software for creating products from these satellites.

The Pathfinder Atmospheres Extended (PATMOS-x) is a NOAA/NESDIS climate dataset generated in partnership with CIMSS. PATMOS-x was selected as one of the first three Climate Data Records (CDR) to become operational CDRs at the National Climatic Data Center (NCDC). The NCDC Climate Data Record Program is also supporting CIMSS and ASPB scientists to lead of a multi-institutional Cryosphere Product Development Team to create a variety of fundamental and thematic snow and ice climate data records (FCDR and TCDR).

### **3. Stimulate the training of scientists and engineers in those disciplines comprising the atmospheric and earth sciences.**

CIMSS continues to support NOAA's education and outreach goals. These activities span the education landscape through involvement in K-12, undergraduate, graduate and professional training. The CIMSS Education and Public Outreach Office reports to the CIMSS Director and assures the education activities are infused throughout the institute's mission.

NOAA and NASA grants support graduate students in the UW–Madison Department of Atmospheric and Oceanic Sciences (see Appendix 4) who work closely with CIMSS and ASPB scientists. The strong link between education and research at CIMSS provides an excellent path for young scientists entering careers in geophysical fields. Several graduate students are now working for public and private industries to support NOAA activities.



CIMSS works in collaboration with NOAA and other cooperative institutes in developing training resources for NOAA. The Satellite Hydro-Meteorology (SHyMet) training course was developed and implemented through close collaboration with experts at the CIRA. CIMSS has assisted in the development of the previous five SHyMet courses. Data for case studies/training modules continues to be added to the CIMSS Satellite Blog (<http://cimss.ssec.wisc.edu/goes/blog/>); blog posts include data from MODIS and Suomi NPP VIIRS that can serve as a proxy for GOES-R and JPSS.

A stable AWIPS-II platform at CIMSS allows for manipulation of CIMSS-produced datasets into formats that are compatible with AWIPS-II formats. Thus, the production at CIMSS of products that forecasters wish to see (for example, GOES-R Fog/Low Stratus Products) continues into the AWIPS-II era.

Use of satellite-based weather products in forecasting is enhanced through stationing a CIMSS satellite scientist at the National Weather Service Training (NWS) Center and another at the Aviation Weather Center (AWC) in Kansas City, MO. The CIMSS scientists provide leadership, satellite expertise, and meteorological support for the GOES-R Proving Ground efforts based at the NWS Training Center (NWSTC). The CIMSS collaboration with the NWS Operations Proving Ground focuses on maximizing analysis and forecast value of geostationary satellite data and products, particularly activities centered on NWS weather forecast office operations to improve forecast and warning services to the nation.

CIMSS Education and Public Outreach (EPO) initiatives prioritize satellite remote sensing awareness and weather and climate literacy while working to ensure that CIMSS research products provide maximum benefits to society. CIMSS EPO is involved in a variety of formal and informal education projects, ranging from classes and workshops at the University of Wisconsin–Madison to presentations at conferences, museums and schools. The GOES-R Education Proving Ground (<http://cimss.ssec.wisc.edu/education/goesr/>) features the design and development of pre- and post-launch lesson plans and activities for G6-12 teachers and students to ensure that the education community will be “launch ready” for new satellite imagery and improved products that will be available in the upcoming GOES-R era. A key element of this effort is a core group of educators working with Education and Outreach staff at the CIMSS in close coordination with NOAA scientists at the ASPB and members of GOES-R Algorithm Working Group at CIMSS.

In the digital domain, CIMSS maintains educational content via on-line curriculum for students and teachers linked from the CIMSS education webpage, (<https://cimss.ssec.wisc.edu/education/>). CIMSS twitter account (@UWCIMSS) continues to be of interest to a broad public. The associated twitter account (@CIMSS\_Satellite) has over 4,400 followers. The CIMSS Satellite Blog (<http://cimss.ssec.wisc.edu/goes/blog/>) has been showcasing examples of meteorological satellite images and products for over 20 years (beginning with the GOES Gallery).

## Summary

CIMSS is excited to begin another 5-year cooperative agreement with NOAA to collaboratively work to achieve the mission goals of our two organizations. The remainder of this report discusses activities during the period July 1, 2015 through March 31, 2016.



## II. Background Information on the Cooperative Institute for Meteorological Satellite Studies (CIMSS)

### 1. Description of CIMSS, including research themes, vision statement and NOAA research collaborations

The Cooperative Institute for Meteorological Satellite Studies (CIMSS) was formed through a Memorandum of Understanding between the University of Wisconsin–Madison (UW–Madison) and the National Oceanic and Atmospheric Administration (NOAA). The CIMSS formal agreement with NOAA began in 1980 and was continued through a competitive review process in 2010. Following a thorough review of the CIMSS, the Review Panel unanimously agreed to a performance rating of Outstanding. CIMSS completed its 5-year review in December 2013 and a new cooperative agreement funding number was in place in 2015.

The CIMSS mission includes three goals:

- Foster collaborative research among NOAA, NASA, and the University in those aspects of atmospheric and earth system science that exploit the use of satellite technology;
- Serve as a center at which scientists and engineers working on problems of mutual interest can focus on satellite-related research in atmospheric and earth system science;
- Stimulate the training of scientists and engineers in the disciplines involved in atmospheric and earth sciences.

To achieve these mission goals CIMSS conducts a broad array of research and education activities, many of which are projects funded through this Cooperative Agreement with NOAA. This Cooperative Agreement identifies four CIMSS themes:

1. Satellite Meteorology Research and Applications, to support weather analysis and forecasting through participation in NESDIS product assurance and risk reduction programs and the associated transitioning of research progress into NOAA operations,
2. Satellite Sensors and Techniques, to conduct instrument trade studies and sensor performance analysis supporting NOAA's future satellite needs as well as assisting in the long term calibration and validation of remote sensing data and derived products,
3. Environmental Models and Data Assimilation, to work with the Joint Center for Satellite Data Assimilation (JCSDA) on improving satellite data assimilation techniques in operational weather forecast models, and
4. Outreach and Education, to engage the workforce of the future in understanding and using environmental satellite observations for the benefit of an informed society.

The collaborative relationship between NOAA and the UW–Madison which led to the establishment of CIMSS has provided outstanding benefits to the atmospheric science community and to the nation through improved use of remote sensing measurements for weather forecasting, climate analysis and environmental issues. CIMSS research investigations increase understanding of remote sensing and its numerous applications to weather and nowcasting/forecasting, clouds, aerosols and radiation, the global hydrological cycle, environmental trends, and climate, as well as education and outreach.

CIMSS scientists are engaged in a broad array of research activities and applications as summarized above and presented in detail in the following sections. Our research process is represented in the figure below. Algorithms are developed and applied to observations (data) to



yield information about Earth. We apply this information to gain knowledge about the Earth system, knowledge that can be utilized in decision-making processes. As we rely on this knowledge to take action we demonstrate the need for better observations, and work with our partners, particularly those in SSEC, in designing and testing improved instrumentation. At the center of this research process is education - the training of students, professionals and ourselves.

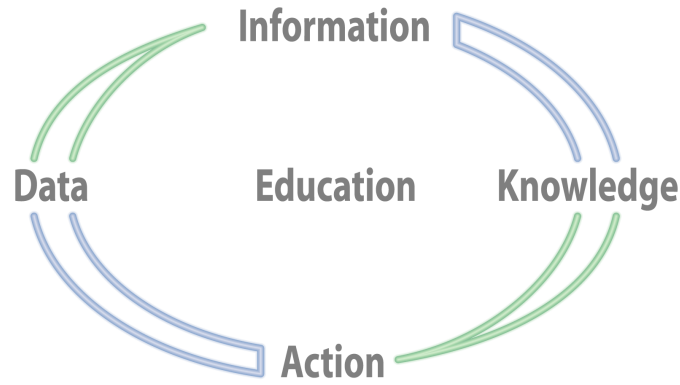

CIMSS conducts a broad array of activities that engages researchers and students in a variety of research and education endeavors.

CIMSS plays a unique role to NOAA as a non-profit partner, advisor, consultant and link to UW-Madison students and researchers. As a long-term partner of NOAA, CIMSS helps to serve as part of the NESDIS corporate memory, particularly when government staff change positions and roles. For example, original CIMSS/SSEC staff associated with GOES VAS (the first geostationary sounding instrument) and GOES-8/14 design, testing, and checkout are now assisting with similar activities in GOES-R/T. On the polar orbiting satellite side, our decades long work with the TOVS and ATOVS sounders and the aircraft HIS (High spectral resolution Interferometer Sounder) and scanning-HIS are aiding in the development of applications for the CrIS (Cross-track Infrared Sounder) hyperspectral sounder on Joint Polar Satellite System (JPSS). In addition to bringing “corporate memory” to these new GOES and JPSS programs, the senior staff help to train the next generation of CIMSS scientists who will support future partnerships between CIMSS and NOAA.

CIMSS scientists work side-by-side with the NESDIS/STAR/ASPB (Advanced Satellite Products Branch) scientists who are stationed in Madison. Being collocated in the same building and having similar research interests fosters powerful ties and collaborations. In addition to working with CIMSS scientists, ASPB scientists often mentor graduate students on research projects. These research projects address NOAA needs while helping to satisfy UW-Madison degree requirements. Based on this positive experience, some of these students go on to work with NOAA and supporting contractors.

Within the NOAA National Weather Service (NWS), CIMSS collaborates on data assimilation projects with the National Centers for Environmental Prediction (NCEP). The CIMSS tropical cyclone research team maintains close collaboration on new products development with the Tropical Prediction Center (NCEP/TPC) in Miami. CIMSS works with the Storm Prediction Center (NCEP/SPC) in Norman, OK on satellite applications to severe weather analysis and forecasting. CIMSS collaborates with the Aviation Weather Center (NCEP/AWC) in Kansas City on aviation safety projects that utilize weather satellite data.



## 2. CIMSS Management and Administration

CIMSS resides as an integral part of the Space Science and Engineering Center (SSEC). CIMSS is led by its Director, Dr. Steven Ackerman, who is also a faculty member within the UW–Madison Department of Atmospheric and Oceanic Sciences. Executive Director – Science Wayne Feltz provides day-to-day oversight of the CIMSS staff, science programs, and facilities. The individual science projects are led by University Principal Investigators (PIs) in conjunction with a strong and diverse support staff who provide additional expertise to the research programs. CIMSS is advised by a Board of Directors and a Science Advisory Council (Section II. 4 below).

The CIMSS administrative home is within the Space Science and Engineering Center (SSEC), a research and development center within the UW–Madison’s Graduate School. The independent CIMSS 5-year review panel for administration wrote that they were “...impressed by the people, systems and processes in place.” The SSEC mission focuses on geophysical research and technology to enhance understanding of the Earth, other planets in the Solar System, and the cosmos. To conduct its science mission on the UW–Madison campus, SSEC has developed a strong administrative and programmatic infrastructure. This infrastructure serves all SSEC/CIMSS staff.

SSEC support infrastructure includes:

- **Administrative support**  
The administrative support team includes approximately 14 full-time staff and several students providing services that include human relations, proposal processing and publishing, grant and contract management, accounting, financial programming, purchasing and travel.
- **Technical Computing**  
The technical computing support team includes 6 full-time staff and several students providing consultation and implementation on system design, networking infrastructure, and full support for Unix and pc computing.
- **Data Center**  
The SSEC Data Center provides access, maintenance, and distribution of real-time and archive weather and weather satellite data. The Data Center currently receives data from 8 geostationary and 7 polar orbiting weather satellites in real time and provides a critical resource to SSEC/CIMSS researchers.
- **Library and Media**  
SSEC maintains an atmospheric science library as part of the UW–Madison library system. A full time librarian is on staff and two part time assistants. SSEC also employs a full time media specialist to support the dissemination of information on scientist activities and research results and to develop in-house publications.
- **Visualization Tools**  
SSEC is a leader in developing visualization tools for analyzing geophysical data. The Man-computer Interactive Data Access System (McIDAS and McIDAS-V), Vis5D and VisAD software are used worldwide in a variety of research and operational environments. The VISITView software is used extensively as a tele-training tool by the NWS and others. To further support NOAA NWS forecast offices, CIMSS is developing satellite products for AWIPS and AWIPS2, maintaining both systems within our facilities.

## 3. Summary of NOAA Funding to CIMSS in FY2015

In FY2015, funding to CIMSS through Cooperative Agreement NA15NES4320001 totaled \$11,565,890. FY2016 funding is not sufficiently known at this time to include in this report but



will most likely be close to CIMSS CA FY2015 budget total. The following tables and graphics show the distribution of these funds by Task, by NOAA Strategic Goal and by CIMSS Research and Outreach Theme. The total represents FY2015 funds provided to CIMSS under the Cooperative Agreement that began on 1 July 2015 and covers the 9 month period from 1 July 2015 to 31 March 2016.

### FY2014 Funding by NOAA Task

CIMSS Task	Funding in dollars	Percentage
Task 1: Administration	\$ 297,864	3%
Task 2: Research primarily with NESDIS Scientists	\$ 11,565,890	97%
Task 3: Research with other NOAA Programs	\$ 0	0%
	\$11,863,754	

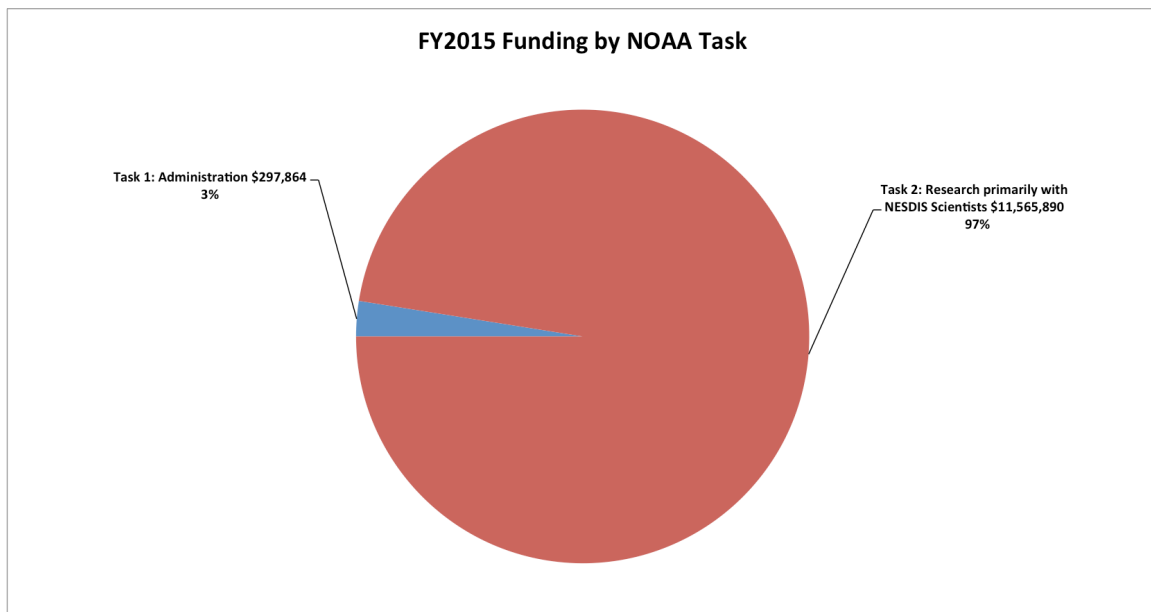

Nearly 97% of CIMSS funding is for Task 2 (~77 employee FTE funded at 50% or greater) and is research conducted with ASPB scientists.



Funding, not including task 1, is shown below and is an increase of about \$1M over last year support. Research primarily falls under NOAA's Strategic Goal Weather Ready Nation.

### Funding by NOAA Strategic Goal

NOAA Strategic Goal	Funding in dollars	Percentage
Weather-Ready Nation	\$10,823,347	94%
Climate Adaption and Mitigation	\$709,000	6%
Healthy Oceans	\$ 0	0%
Resilient Coastal Communities and Economies	\$33,543	1%
	\$11,565,890	

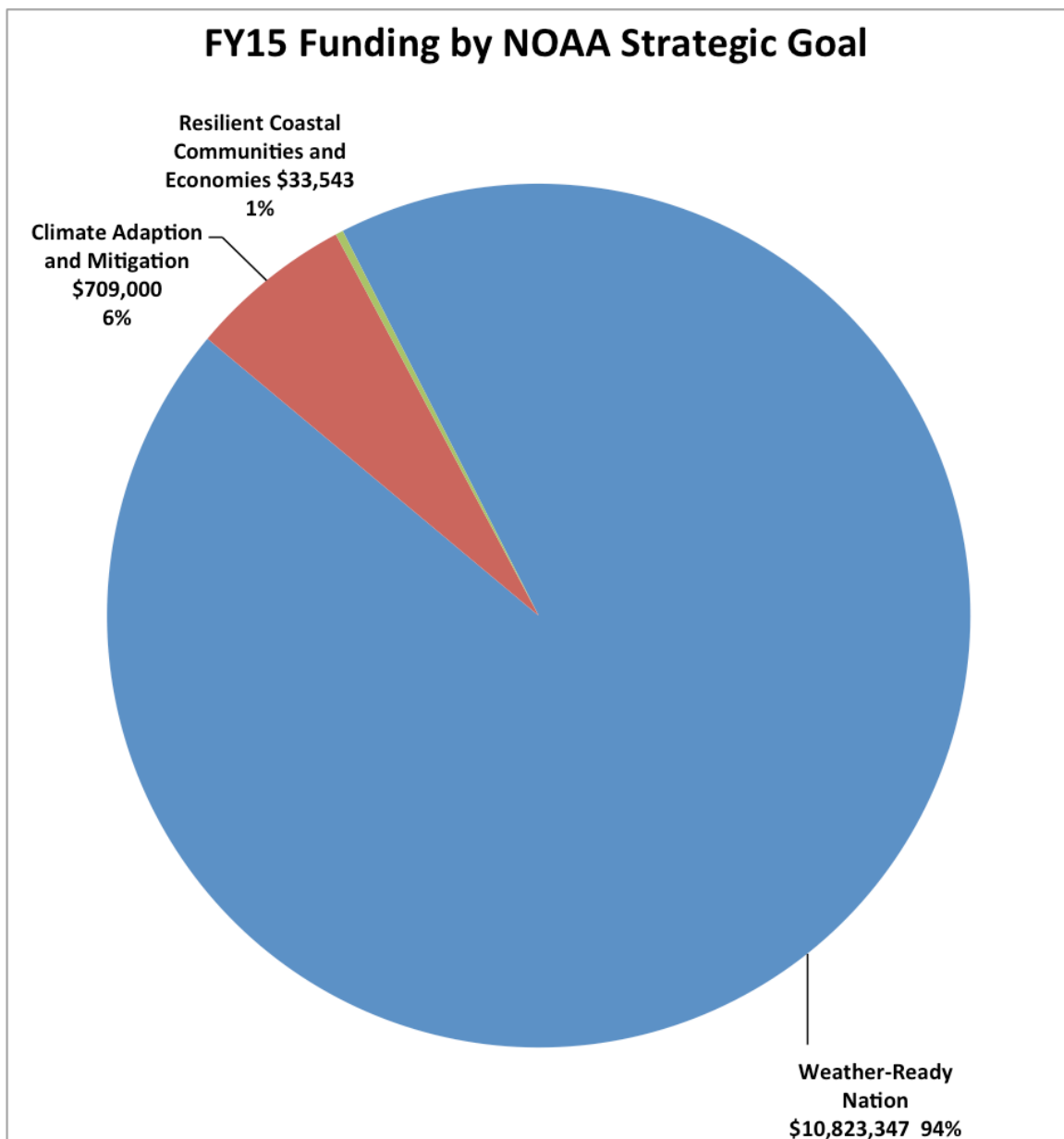



### Task 2 Funding by CIMSS Research and Outreach Themes

CIMSS Theme	Funding in dollars	Percentage
Satellite Meteorology Research and Applications	\$7,201,061	62%
Satellite Sensors and Techniques	\$2,720,714	23%
Environmental Models and Data Assimilation	\$854,501	7%
Education and Outreach	\$838,644	7%
	\$11,605,920*	

\* - does not include the Task 1 funding

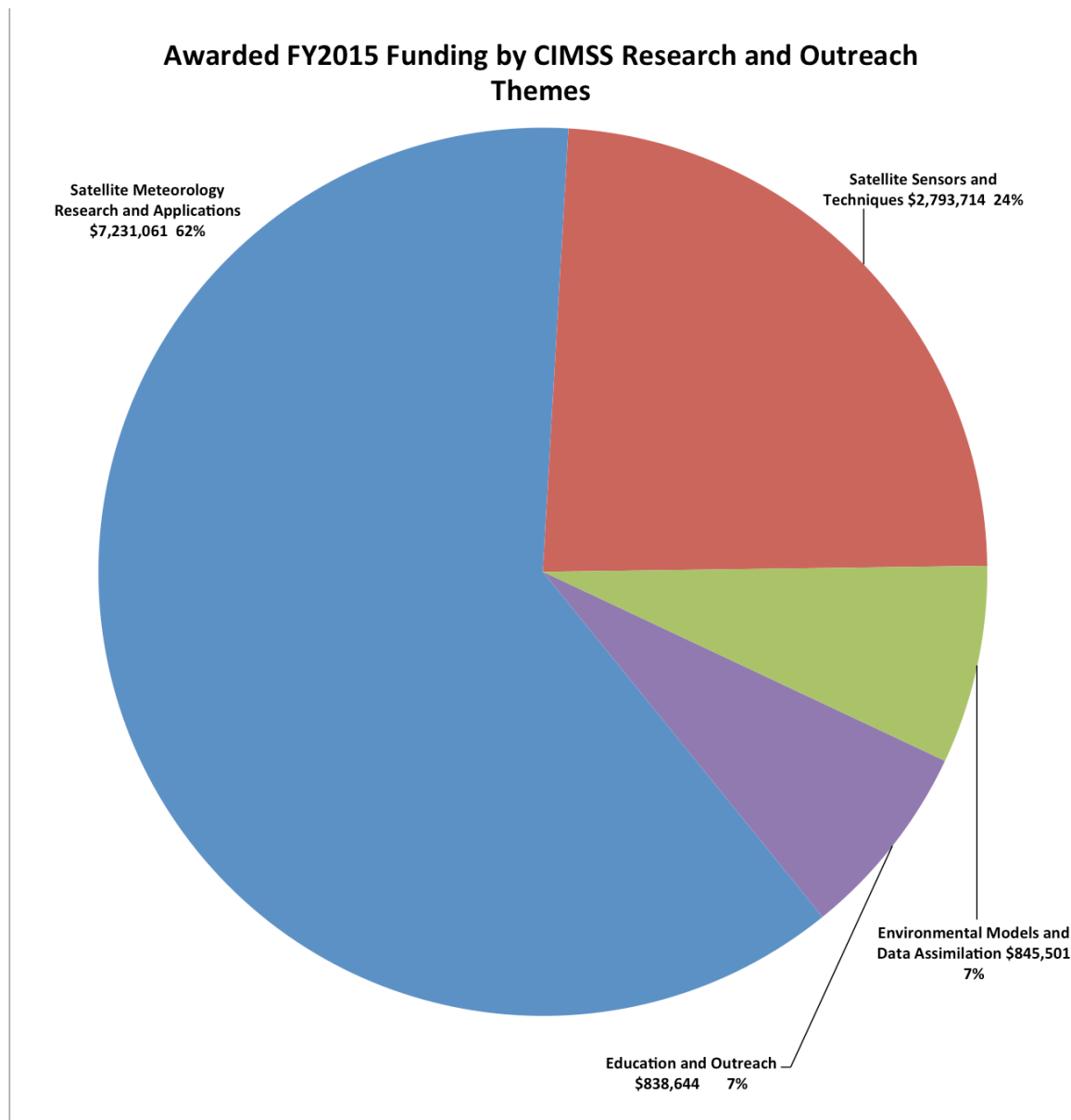





### III. Project Reports

The sections below provide two-three page summaries for each of the various projects funded by NOAA through the CIMSS cooperative agreement. Each summary lists the project leader, the NOAA goals and the CIMSS themes followed by a summary of the project accomplishments this past year. Where appropriate, relevant publications and conference presentations are listed.

#### 1. CIMSS Task 1A Support – Administration

**CIMSS Task Leaders: Steve Ackerman, Wayne Feltz**

**CIMSS Support: Maria Vasys, Leanne Avila, Wenhua Wu, Margaret Mooney**

**Budget: \$247,864**

##### NOAA Long Term Goals:

- Climate Adaptation and Mitigation
- Weather-Ready Nation

##### NOAA Strategic Goals:

- Provide critical support for the NOAA mission

##### CIMSS Research Themes:

- Satellite Meteorology Research and Applications
- Satellite Sensors and Techniques
- Environmental Models and Data Assimilation
- Education and Outreach

##### Objective

The CIMSS Task I funds continue to support the specific administrative needs for the CIMSS Director, the CIMSS Executive Director - Science and the CIMSS Staff Program Assistant Maria Vasys provides that support and is also supported by student hourly employees to maintain a consistent presence in the CIMSS administrative office.

##### Project Overview

The CIMSS Task 1 funding supports activities related to CIMSS-specific administration and non-research programs that are important to the workplace environment of CIMSS. Partial funding support is provided for the CIMSS Director, Executive Director - Science, the Program Assistant, and the CIMSS Webmaster. Task I activities also includes leveraging support for education and outreach projects, per diem support for visiting scientists, post doctoral positions and first year graduate students.

##### Milestones with Summary of Accomplishments and Findings

Task I activities are related to the overall management of CIMSS, as well as general education and outreach activities. These are activities which support the operation of CIMSS; provide outreach platforms to transmit CIMSS science to varied audiences; train and develop future scientists in the workforce; and provide capabilities requested under the Federal Funding Opportunity NOAA-NESDIS-NESDISPO-2015-4320001, but which are not tied to a specific project or projects. Task I funding includes partial funding/salary support for the CIMSS PI/Director, Steve Ackerman, and other support staff, travel, and visiting researcher support. Also, inclusive of Task I are educational and outreach activities including support of post-docs and graduate students within CIMSS not assigned to specific projects or research; support of



undergraduate research interns; development of community outreach, education, and training programs; and support for CIMSS education and outreach staff.

Task I funding supports the development and updates of the CIMSS Web page (see <http://cimss.ssec.wisc.edu/>). The home page provides an innovative approach to the research pages by allowing users to access CIMSS research projects via three paths: alphabetically, by observing platform and by CIMSS research theme. The CIMSS Web page is closely linked to the NOAA ASPB Web site (<http://cimss.ssec.wisc.edu/aspb/>) and to the SSEC Web site (<http://www.ssec.wisc.edu>).

CIMSS has created the “NOAA-CIMSS Collaborative Award for developing NOAA’s Strategic Satellite Plan to balance requirements, observation capabilities, and resources.” These awards may be given to CIMSS scientists who have worked closely with NOAA scientists who have received a NOAA award. The CIMSS award is to recognize the partnership that occurs in research with ASPB and UW-Madison scientists.

## **2. CIMSS Task 1B Support – Education and Outreach**

**CIMSS Task Leaders: Margaret Mooney and Steve Ackerman**

**CIMSS Support Scientists: Scott Bachmeier and Rick Kohrs**

**NOAA Collaborators: Tim Schmit, Steve Goodman, Nina Jackson, and LuAnn Dahlman**

**Budget: \$50,000**

### **NOAA Long Term Goals:**

- Climate Adaptation and Mitigation
- Weather-Ready Nation

### **NOAA Strategic Goals:**

- Serve society’s needs for weather and water
- Understand climate variability and change to enhance society’s ability to plan and respond
- Provide critical support for the NOAA mission

### **CIMSS Research Themes:**

- Satellite Meteorology Research and Applications
- Education and Outreach

### **Objective**

To maximize the benefit of CIMSS research products to society through a variety of education and outreach efforts.

### **Project Overview**

CIMSS Education and Public Outreach (EPO) initiatives prioritize satellite remote sensing awareness and weather and climate literacy while working to ensure that CIMSS research products provide maximum benefits to society. CIMSS EPO is involved in a variety of formal and informal education projects, ranging from classes and workshops at the University of Wisconsin-Madison to presentations at conferences, museums and schools. CIMSS has been on the forefront of educational software design for over two decades and currently supports several on-line curriculums, educational tools, social media sites and blogs.



## Milestones with Summary of Accomplishments and Findings

CIMSS EPO efforts include local and national initiatives, starting with the CIMSS high school student workshop, a STEM camp held each summer since 1991. In September, CIMSS presented and participated in the 11<sup>th</sup> annual Cooperative Research Program (CoRP) Science Symposium in Maryland. Year-round, CIMSS researchers and staff conduct numerous in-person presentations at formal and informal venues.

At the January 2016 annual American Meteorological Society meeting, CIMSS organized a twitter-driven trivia contest (#AmsEd25) in honor of the 25th anniversary of the AMS Symposium on Education consisting of 25 questions and three 1st-place prizes. As always, numerous presentations and posters were presented at multiple AMS symposiums.

As a NOAA Weather-Ready Nation Ambassador™, CIMSS led the 2015 effort for the University of Wisconsin-Madison to become StormReady, a designation that was conferred in September. This achievement followed months of effort and coordination between the UW-Madison and the Milwaukee-Sullivan National Weather Service (NWS) Forecast Office. A plaque was awarded to the UW-Madison Chancellor (and former United States Secretary of Commerce) Rebecca Blank by NWS Director Louis Uccellini in a small ceremony on campus.



**Figure 1.** Left to Right: Steve Bruske (NWS), Bill Curtis (UW-Madison EM), Tim Halbach (NWS), Louis Uccellini (NWS), UW-Madison Chancellor Rebecca Blank, Steve Ackerman (CIMSS & AOS), Margaret Mooney (CIMSS), Shane Hubbard (CIMSS) *Photo Credit: Bill Bellon (SSEC)*

In the digital domain, CIMSS maintains educational content via on-line curriculum for students and teachers linked from the CIMSS education webpage, (<https://cimss.ssec.wisc.edu/education/>) CIMSS also maintains two twitter accounts and a Facebook page. @UWCIMSS, in its second year, covers broad range of content and has nearly 3000 followers. (up from 772 a year ago) The CIMSS Facebook page (<https://www.facebook.com/CIMSS.UW.Madison>) has just over 5,200 fans. Two notable posts from 2015 include an interview and tour of the Milwaukee/Sullivan



National Weather Service office that received over 10,000 views and a radar animation of Hurricane Winston making landfall on Fiji which reached over 24,000 people.

The CIMSS Satellite Blog (<http://cimss.ssec.wisc.edu/goes/blog/>) has been showcasing examples of meteorological satellite images and products for over a decade. The associated twitter account (@CIMSS\_Satellite) has over 5,600 followers.

The massive open on-line course (MOOC) that CIMSS co-produced with the UW-Madison Atmospheric and Oceanic Sciences Department called *The Changing Weather and Climate of the Great Lakes Region* remained on-line and accessible on Coursera through the end of the calendar year when over 8,000 people had registered and accessed content. Much of the course has since been moved to a permanent CIMSS web page. (<http://cimss.ssec.wisc.edu/education/mooc/>)

CIMSS has also been producing content for NOAA’s Science On a Sphere® (SOS) and in 2015 published 12 monthly climate digests and a feature story entitled “The State of our Lakes”. (<http://sphere.ssec.wisc.edu/>)

Finally, the GOES-R Education Proving Ground (<http://cimss.ssec.wisc.edu/education/goesr/>) led by CIMSS, expanded in 2015 from six educators from 3 states to 30 teachers from 13 states and Puerto Rico in advance of the October 2016 launch. These teachers are attending webinars, implementing new activities and lessons plans, and developing plans to promote the GOES-R launch in their schools and school districts.



Figure 2. GOES-R Educators

Ensuring that the education community is *launch-ready* for new satellite imagery and improved products in the GOES-R era will be a high priority for CIMSS in 2016 and beyond.

### Publications and Conference Reports

Handlos, Zachary; Mooney, M.; Ackerman, S. and Brossard, D. Assessment of climate literacy within a Massive Open Online Course based on information disseminated by mass media. Symposium on Societal Applications, 11th, Policy, Research and Practice, New Orleans, LA, 10-14 January 2016.



Ackerman, Steve; Mooney, M.; Morrill, J.; Handlos, Z. and Morrill, S. Climate literacy through a partnership with public libraries. Symposium on Education, 25th, New Orleans, LA, 10-14 January 2016.

Mooney, Margaret; Schmit, T. J.; Whittaker, T. M. and Ackerman, S. GOES-R education proving ground. Annual Symposium on New Generation Operational Environmental Satellite Systems, 12th, New Orleans, LA, 10-14 January 2016.

Gunshor, Mathew M.; Schmit, T. J.; Schmidt, C. C.; Lindstrom, S. S.; Gerth, J. J.; Mooney, M.; Whittaker, T. M.; Goodman, S. J. and Gurka, J. J. Employing short courses to prepare for the GOES-R satellite series. Annual Symposium on New Generation Operational Environmental Satellite Systems, 12th, New Orleans, LA, 10-14 January 2016.

Mooney, Margaret; Dahlman, L.; Lewis, P. M. and Robinson, E. ESIP education workshops. Symposium on Education, 25th, New Orleans, LA, 10-14 January 2016.

### **3. CIMSS Participation in the Product Systems Development and Implementation (PSDI) for 2015**

#### **3.1 Polar PSDI: Transition of MODIS and AVHRR Winds to GOES-R/VIIRS Algorithm**

**CIMSS Task Leader: David Santek, Steve Wanzong**

**NOAA Collaborators: Jeff Key, Jaime Daniels**

**Budget: \$25,000**

#### **NOAA Long Term Goals:**

- Weather-Ready Nation

#### **NOAA Strategic Goals:**

- Serve society's needs for weather and water
- Provide critical support for the NOAA mission

#### **CIMSS Research Themes:**

- Satellite Meteorology Research and Applications
- Satellite Sensors and Techniques

#### **Objective**

To assist in the transition of the heritage winds software to the new nested tracking algorithm for the MODIS and AVHRR polar winds products, at CIMSS, satellite Direct Broadcast sites, and NESDIS operations.

#### **Project Overview**

The MODIS and AVHRR polar winds products that are currently operational provide wind speed, direction, and height at high latitudes. The VIIRS polar winds product uses the new nested tracking algorithm designed for GOES-R ABI. Because the MODIS/AVHRR and VIIRS winds products are generated with different algorithms, they will exhibit different error characteristics. The nested tracking is more accurate than the heritage algorithm used for MODIS and AVHRR because it uses an externally-generated cloud product and a more robust tracking approach.



The goal is to use the nested tracking winds software across the suite of polar winds products, which will result in a consistent algorithm across the polar instruments (VIIRS, AVHRR, MODIS) and the geostationary satellites (GOES-East and -West).

### **Milestones with Summary of Accomplishments and Findings**

The CIMSS team continues to work with STAR scientists and contractors as well as the STAR Algorithm Integration Team (AIT) in the implementation of nested tracking code for MODIS and AVHRR polar winds, which is currently underway in NESDIS operations.

As part of the transition evaluation, we are formulating a plan to develop validation tools to compare the polar winds product between the two algorithms. This includes the ability to easily reprocess case studies and automated techniques for statistical comparison and validation with independent observations, e.g. radiosondes.

Upcoming milestones:

- Jun 2016 – Complete the installation of the nested tracking algorithm at CIMSS,
- Sep 2016 - Transition the real-time MODIS winds processing at CIMSS to use the nested tracking algorithm,
- Nov 2016 - Transition the real-time AVHRR winds processing at CIMSS to use the nested tracking algorithm,
- Feb 2017 – Complete the transition of the real-time MODIS and AVHRR winds at Direct Broadcast locations to use the nested tracking algorithm,
- Mar 2017 – Begin the development of a case study infrastructure and statistical validation tools.

### **3.2 An Enterprise Processing System for Polar (CLAVR-x) Products**

**CIMSS Task Leader: William Straka III**

**CIMSS Support Scientist: Steve Wanzong**

**NOAA Collaborator: Andrew Heidinger**

**Budget: \$30,000**

**NOAA Long Term Goals:**

- Weather-Ready Nation

**NOAA Strategic Goals:**

- Serve society's needs for weather and water
- Support the nation's commerce with information for safe, efficient and environmentally sound transportation
- Provide critical support for the NOAA mission

**CIMSS Research Themes:**

- Satellite Meteorology Research and Applications
- Satellite Sensors and Techniques

### **Objective**

The objective of this project is to assist NESDIS in transitioning CLAVR-x functionality into the SAPF



## **Project Overview**

The Clouds from AVHRR Extended (CLAVR-x) has been the operational NESDIS cloud processing system for the Advanced Very High Resolution Radiometer for over 10 years. With the advent of the NESDIS Framework, NESDIS desires that all operational processing occur with the STAR Algorithm Processing Framework (referred to SAPF in this proposal).

## **Milestones with Summary of Accomplishments and Findings**

The updated GOES-R cloud algorithms which run on AVHRR have been successfully integrated into the SAPF. Code detailing the ingest of AVHRR data has been provided to NESDIS to be integrated into the SAPF.

Milestone. We are currently working on validating the output of the L1b data from the SAPF. In addition, the enterprise algorithms, which are used in CLAVR-x, have been integrated into the SAPF and are awaiting for the L1b to be validated before testing.

### **3.3 Polar PSDI: Enterprise Processing Ground System – Volcanic Ash Products**

**CIMSS Task Leader: Justin Sieglaff**

**NOAA Collaborator: Mike Pavolonis**

**Budget: \$50K**

#### **NOAA Long Term Goals:**

- Weather-Ready Nation

#### **NOAA Strategic Goals:**

- Serve society's needs for weather and water
- Support the nation's commerce with information for safe, efficient and environmentally sound transportation
- Provide critical support for the NOAA mission

#### **CIMSS Research Themes:**

- Satellite Meteorology Research and Applications
- Satellite Sensors and Techniques

#### **Objective**

Support AVHRR processing for the GOES-R Enterprise Volcanic Ash Algorithm.

## **Project Overview**

The Clouds from AVHRR Extended (CLAVR-x) has been the operational NESDIS cloud processing system for the Advanced Very High Resolution Radiometer (AVHRR) for over 10 years. The CLAVR-x output is currently being used by NCEP for NWP verification as well as the IASI processing at ESPC. In addition, CLAVR-x is used as input for Cloud product composites over Alaska.

This goal of the project is to make sure that the legacy applications of both GSIP and CLAVR-x are transitioned into NESDIS Operational Framework System (NOFS).

A 2nd goal of this project is to address SPSRB user request 0507-05 submitted by the Washington Volcanic Ash Advisory Center (VAAC). The request is to complete the transition of the AVHRR derived volcanic ash products to NESDIS operations within the AIT Framework. We



therefore propose to work with the STAR AIT to transition these products into NESDIS operations. The inclusion of this component into the Enterprise Processing Ground System project will address long-standing hardware architecture issues that prevented AVHRR volcanic ash products from being generated operationally within in NESDIS.

### **Milestones with Summary of Accomplishments and Findings**

- *Implement and execute enterprise volcanic ash delivery schedule*  
We have worked with STAR AIT on establishing a delivery schedule for enterprise volcanic ash codes. The AIT Midwest continues to work with both algorithm developers and STAR AIT ensuring code deliveries are on schedule and solving any problems during the code implementation.
- *Validate enterprise volcanic ash algorithm output*  
Upon completion of the enterprise volcanic ash algorithm implementation within the AIT framework, the AIT will run test cases using AVHRR inputs. The algorithm developers will validate the AIT framework output agrees with output generated using the developer's processing system. The algorithm developers have developed scripts utilizing SSEC's validation code (GLANCE) to complete this task once sample data becomes available.

### **References**

Pavlonis, M. J., J. Sieglaff, and J. Cintineo (2015a), Spectrally Enhanced Cloud Objects (SECO): A Generalized Framework for Automated Detection of Volcanic Ash and Dust Clouds using Passive Satellite Measurements, Part I: Multispectral Analysis, *J. Geophys. Res. Atmos.*, 120, doi:[10.1002/2014JD022968](https://doi.org/10.1002/2014JD022968).

Pavlonis, M. J., J. Sieglaff, and J. Cintineo (2015b), Spectrally Enhanced Cloud Objects (SECO): A Generalized Framework for Automated Detection of Volcanic Ash and Dust Clouds using Passive Satellite Measurements, Part II: Cloud Object Analysis and Global Application, *J. Geophys. Res. Atmos.*, 120, doi:[10.1002/2014JD022969](https://doi.org/10.1002/2014JD022969).

### **3.4 GEO PSDI: An Enterprise Processing System for Geostationary (GSIP)**

**CIMSS Task Leader: William Straka III**

**CIMSS Support Scientist: Steve Wanzong**

**NOAA Collaborator: Andrew Heidinger**

**Budget: \$30,000**

#### **NOAA Long Term Goals:**

- Weather-Ready Nation

#### **NOAA Strategic Goals:**

- Serve society's needs for weather and water
- Support the nation's commerce with information for safe, efficient and environmentally sound transportation
- Provide critical support for the NOAA mission

#### **CIMSS Research Themes:**

- Satellite Meteorology Research and Applications
- Satellite Sensors and Techniques





## **Objective**

The goal of this project is to first update GSIP with the latest cloud algorithms and then assist NESDIS in transitioning GSIP functionality into the SAPF.

## **Project Overview**

The GOES Surface and Insolation Project (GSIP) has been the operational NESDIS cloud processing system for the GOES Imagers. NESDIS desires that all future operational processing occur within the STAR Algorithm Processing Framework (referred to SAPF in this proposal).

## **Milestones with Summary of Accomplishments and Findings**

Integration of the updated GOES-R cloud algorithms into GSIP was performed in early 2015 and was successfully tested. Figure 3 shows the results of the latest cloud algorithms integrated into GSIP. Validation of the algorithms was performed as part of the Algorithm Readiness Review, which is to be conducted in April 2016.



Table 1 includes the GSIP specification summary for cloud mask, phase and height. In addition, the updated GOES-R cloud algorithms have been successfully integrated into the SAPF. Currently we are awaiting test cases from current GOES calculated from the SAPF to perform comparisons.

Milestones:

- Update GSIP with enterprise cloud algorithms
- Conduct ARR for GSIP updates
- Deliver Enterprise cloud algorithms to SAPF to run on current GOES.

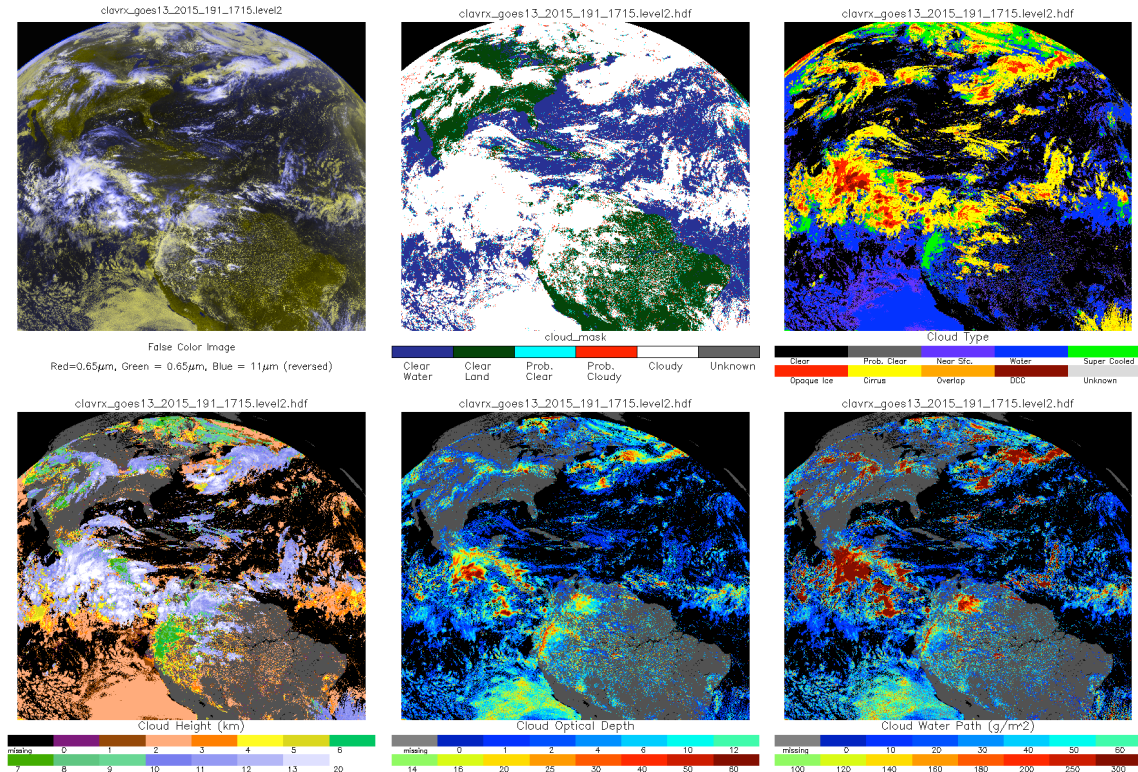

Figure 3. Example GSIP product output.



**Table 1. Summary of GSIP requirements, and observed results.**

	Requirement	GSIP
Cloud Mask % correct	0.87	0.91
Cloud Phase % correct	0.80	0.90
Ice Cloud Accuracy	+/- 1.0	-0.81
Ice Cloud Precision	1.5	1.43
Water Cloud Accuracy	+/- 1.0	0.08
Water Cloud Precision	1.5	1.47

### 3.5 GEO PSDI: Enterprise Processing Ground System – Fog and Low Cloud Products

**CIMSS Task Leader: Corey Calvert**

**CIMSS Support Scientist: William Straka**

**NOAA Collaborator: Michael Pavolonis**

**Budget: \$40,000**

#### NOAA Long Term Goals:

- Weather-Ready Nation

#### NOAA Strategic Goals:

- Serve society's needs for weather and water
- Support the nation's commerce with information for safe, efficient and environmentally sound transportation
- Provide critical support for the NOAA mission

#### CIMSS Research Themes:

- Satellite Meteorology Research and Applications
- Satellite Sensors and Techniques

#### Objective

We seek to transition the GOES-R Fog/Low stratus (FLS) products to NESDIS operations within the AIT framework.

#### Project Overview

The goal of this project is to address SPSRB user request 1305-004, submitted by the NWS, to transition the GOES-R Fog/Low stratus (FLS) products to NESDIS operations within the AIT framework. We therefore propose to work with the STAR AIT to transition the GOES-R FLS algorithm by developing a product interface that can be used within the AIT framework. Once the interface is completed we will continue working with the AIT to evaluate and validate the FLS products in the AIT framework to ensure the quality of the products until the transition is complete.

#### Milestones with Summary of Accomplishments and Findings

- *Critical Design Review for FLS products*  
We successfully completed the CDR for the FLS products. One highlight of the CDR was that the accuracies of the FLS products (validated using surface observations) were all found to meet algorithm specifications.



- *Implementation of FLS algorithm in AIT Framework*  
The initial implementation of the GOES-R FLS algorithm into the AIT framework was successful (see Figure 4).
- *Evaluate output from the AIT Framework*  
In depth evaluation is now underway to ensure the product quality meets our expectations and, if it does not, to resolve any issues.

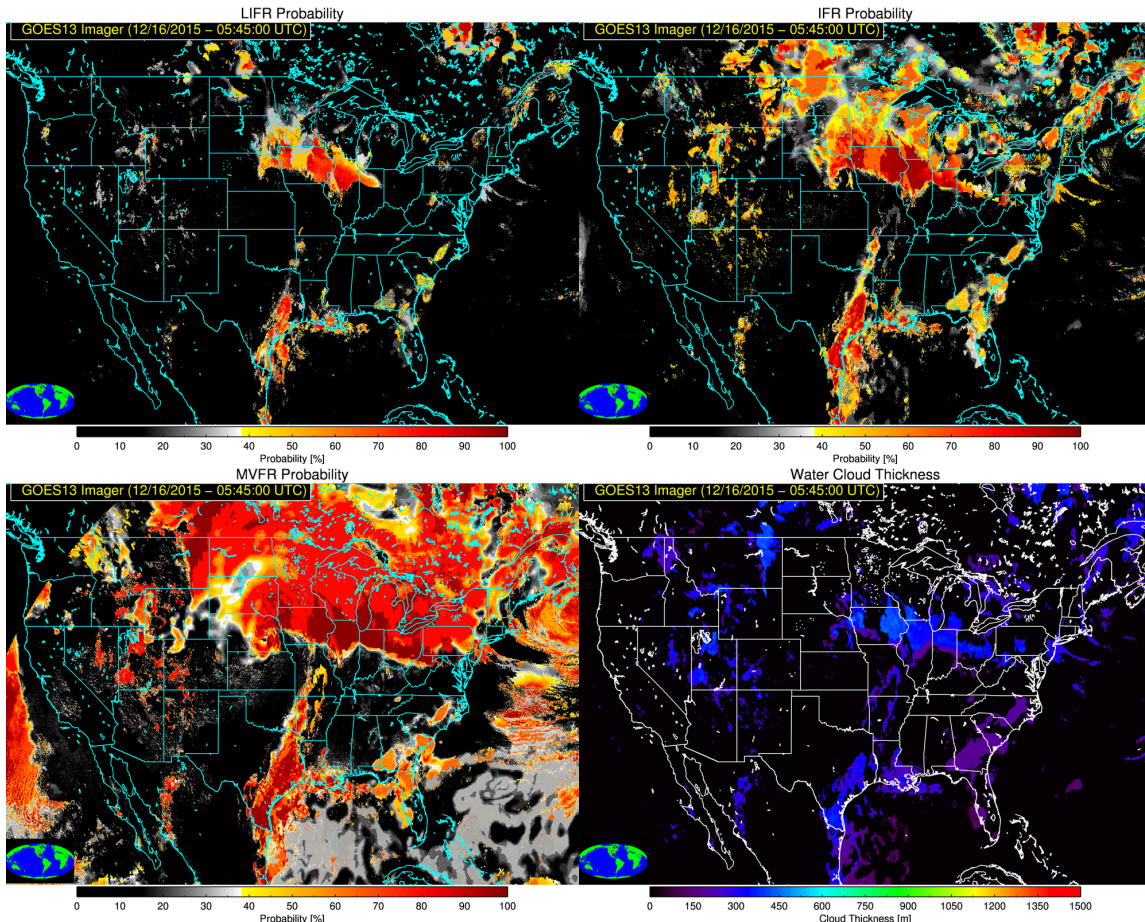

Figure 4. Initial output of the GOES-R FLS products produced by the AIT framework. The values of the LIFR probability (top left), IFR probability (top right), MVFR probability (bottom left) and fog depth (bottom right) products all fall within expected ranges in both magnitude and geographic location indicating the initial implementation of the GOES-R FLS algorithm appears to have been successful.

## 4. CIMSS Participation in the GOES-R Algorithm Working Group (AWG) for 2015-2016

### 4.1 Proxy Data Support

CIMSS Task Leaders: Tom Greenwald and Allen Huang

CIMSS Support Scientists: Jason Otkin, Todd Schaack, Allen Lenzen, Kaba Bah, Marek Rogal

NOAA Collaborators: Brad Pierce

Budget: \$443K



## **NOAA Long Term Goals**

- Weather-Ready Nation

## **NOAA Strategic Goals**

- Serve society's needs for weather and water

## **CIMSS Research Themes**

- Satellite Meteorology Research and Applications
- Environmental Models and Data Assimilation

## **Objective**

Our main goal is to produce high-quality proxy Advanced Baseline Imager (ABI) imagery and products in real time for supporting the National Weather Service (NWS) in preparation for the use of ABI data within the Advanced Weather Interactive Processing System II (AWIPS II), as well as providing these proxy data to the Algorithm Integration Team (AIT) for algorithm testing.

## **Project Overview**

This task supports GOES-R AWG Advanced Baseline Imager (ABI) proxy data capabilities with real-time synthetic Cloud and Moisture Imagery (CMI) that includes effects of clouds, water vapor, aerosols and ozone as well as realistic treatment of surface emissivity and reflectivity for all 16 ABI bands (Greenwald et al., 2016). The advanced modeling system used to produce synthetic CMI consists of full-spectral-resolution global meteorological forecasts from the National Center for Environmental Prediction (NCEP) Global Forecast System (GFS), global  $1^\circ \times 1^\circ$  aerosol forecasts from the Real-time Air Quality Modeling System (RAQMS) (Pierce et al., 2007), regional meteorological and aerosol forecasts from WRF-Chem, as well as MODIS-based surface reflectance and emissivity data sets for constructing simulated radiances from the NOAA Community Radiative Transfer Model (CRTM).

We continue to provide the GOES-R AIT with real-time GOES-R ReBroadcast (GRB) NetCDF files for AIT algorithm testing and collaborate with the AIT to validate Baseline algorithm implementation within the Framework through comparison with products produced at CIMSS using GEOCAT. The real-time proxy data sets are used to support the NWS Advanced Weather Interactive Processing System II and to validate ABI Baseline products of cloud properties, legacy sounding retrievals, aerosol properties, total column ozone, and fire detection. This work is done in close collaboration with the AIT and the NWS.

## **Milestones with Summary of Accomplishments and Findings**

- We delivered ABI CONUS 16-band radiances (2km Fixed Grid GRB files) to the AIT on a nearly continuous basis.
- We worked with Kevin Gallo at NOAA/NESDIS/Center for Satellite Application and Research to help him access and use proxy ABI data from our July 3, 5 and 27, 2014 WRF-Chem runs for their internal validation and testing of products. Gallo and his team at the U.S. Geological Survey Earth Resources Observation and Science (EOOS) Center, occasionally leverage our WRF-Chem-simulated ABI data for algorithm testing and sanity checks.
- Ingest of the original proxy ABI radiances (on the WRF-Chem model grid) and the NOAAPORT AWIPS II imagery (on the AWIPS II grid) into McIDAS-V was evaluated for end-to-end testing of GOES-R ground system processing of AWIPS II ABI imagery (Figure 5).



- We installed and set up a Local Data Manager (LDM) feed on our own local system for sending synthetic ABI data to NWS offices via AWIPS.

## References

Greenwald, T. J., R. B. Pierce, T. Schaack, J. Otkin, M. Rogal, K. Bah, A. Lenzen, J. Nelson, J. Li, and H.-L. Huang, 2016: Real-time Simulation of the GOES-R ABI for user readiness and product evaluation. *Bull. Amer. Meteor. Soc.*, 97, 245-261, DOI:10.1175/BAMS-D-14-00007.1.

Pierce, R. B., et al., 2007: Chemical data assimilation estimates of continental U.S. ozone and nitrogen budgets during the Intercontinental Chemical Transport Experiment–North America. *J. Geophys. Res.*, 112, D12S21, doi:10.1029/2006JD007722.

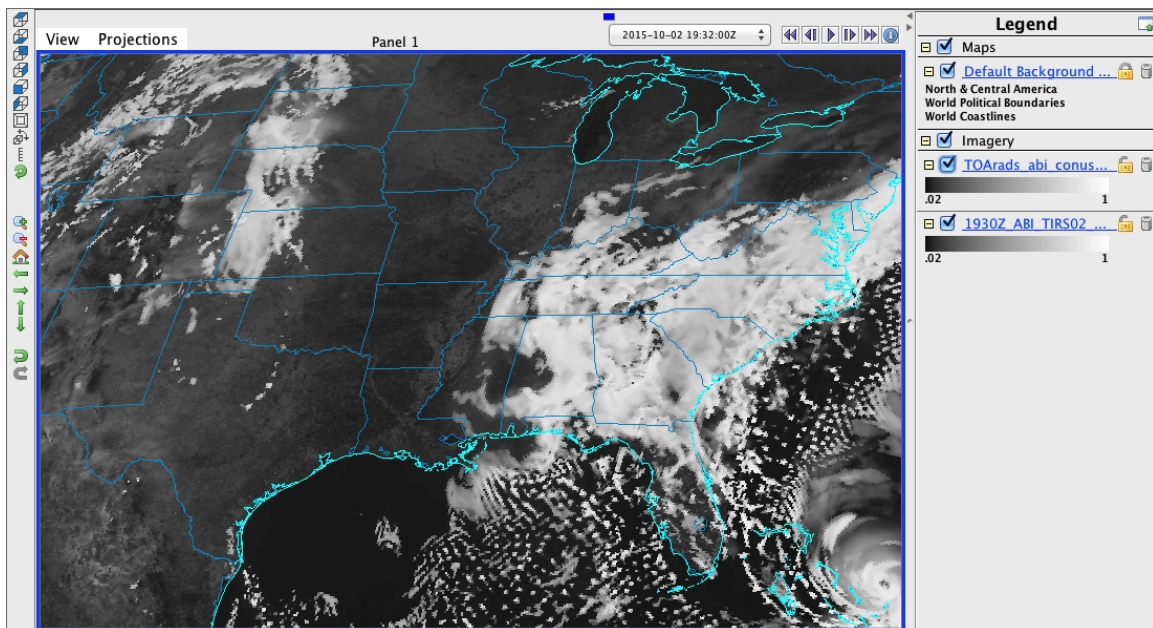

Figure 5. McIDAS-V image at 1900 UTC 2 Oct 2015 from WRF-Chem/CRTM-simulated ABI data at WRF-Chem model resolution.

## 4.2 GOES-R Analysis Facility Instrument for Impacts on Requirements (GRAFIIR)

**CIMSS Task Leader: Mathew Gunshor**

**CIMSS Support Scientists: Hong Zhang, Eva Schiffer**

**NOAA Collaborator: Tim Schmit**

**Budget: \$93,000**

### NOAA Long Term Goals:

- Weather-Ready Nation

### NOAA Strategic Goals:

- Serve society's needs for weather and water
- Provide critical support for the NOAA mission

### CIMSS Research Themes:

- Satellite Meteorology Research and Applications
- Satellite Sensors and Techniques



## Objective

GRAFIIR is to assist the government in assessing the impact of instrument waivers on ABI level 2 products, including impacts on meeting precision and accuracy product requirements.

## Project Overview

The GRAFIIR project has been developed by the scientists and researchers that are also GOES-R AWG product team members and system developers working on ABI. The CIMSS GRAFIIR team interacts with AWG program managers, application and integration team (AIT) members to react to new directions and needs to support associated analysis. Additionally, the CIMSS GRAFIIR team continues to interface with the GOES-R program's Product Working Group (PWG), to assist the government's efforts with ABI waiver analysis and response.

When requested, the AWG utilizes its GRAFIIR-based tool set to measure the effects of Government-specified waivers and deviations (perturbations to instrument capabilities or functionality) on ABI level 1B data and L2+ products. Note that not all of the following tasks will be necessary for every case; the Government team addressing a waiver or potential waiver would decide which tasks to undertake.

### Potential ABI Waiver Analysis Tasks:

- Perturb simulated level 1B datasets to reflect the effects of Government-specified waivers and deviations (perturbations to instrument capabilities or functionality). This will be achieved through application of a mathematical model(s) provided or approved by the Government. Task only necessary if perturbed data are not provided by a non-AWG source.
- Perform a statistical and visual analysis of the unperturbed (control case) and perturbed (test case) simulated level 1B data using GRAFIIR tool sets that include: Glance, McIDAS, IDL, and/or MATLAB.
- Using the AWG framework and baseline GSP approved algorithms, generate level 2+ products from the unperturbed (control run) and perturbed (test run) simulated level 1B data.
- Perform a statistical and visual analysis of the unperturbed (control case) and perturbed (test case) L2+ products using GRAFIIR tool sets (Glance, McIDAS, IDL, and/or MATLAB) and any product validation tools used by AWG product application teams.
- Generate an analysis report that summarizes approach and findings including the L2+ product impacts and conformance/non-conformance to F&PS.

When instrument specifications are changed, new L1B files are produced, products are run, and then products are evaluated in regards to the instrument specification changes (note that imagery is the Key Product Parameter and that analysis may just be of L1B data and images, depending on the needs). The GRAFIIR team will analyze the products to assess the impact of various instrument effects. The GRAFIIR team may utilize AWG product team members to either perform or assist with this analysis when appropriate.

## Milestones with Summary of Accomplishments and Findings

By their nature, waivers are not predictable, which includes the topic of a waiver and the timing. Hence, no milestone dates were chosen for waiver activities. The following were the proposed exercises, or milestones:

- Maintain GRAFIIR datasets and software;
- Respond to AIT requests for support of team product validation activities;



- ABI waiver analysis if necessary: Respond to proposed changes in ABI instrument specifications to assess their potential effects on products, via GOES-R Product Working Group (PWG);
- Update diagnostic tools; and
- Updates to Glance will be made available to AWG/AIT.

This reporting period there was one waiver issue that arose. The 10.35 micrometer band on Flight Model (FM)-4 was outside the specified (“spec”) spectral response function (SRF) envelope. The GRAFIIR team provided a report to the Product Working Group (PWG) with an analysis that showed the difference between the SRF and a spec-compliant SRF along with associated calculated brightness temperature differences. The GRAFIIR team has now addressed 13 waivers and instrument deviations to date (Figure 6).

Glance development this period included compatibility investigations with special file types. Specifically, GOES-R ground system files and Himawari files generated from Himawari Standard Format (HSF) at CIMSS were being investigated. Glance continues to be a popular tool for many teams associated with the GOES-R program and its use has spread beyond GOES-R to other programs, such as JPSS.

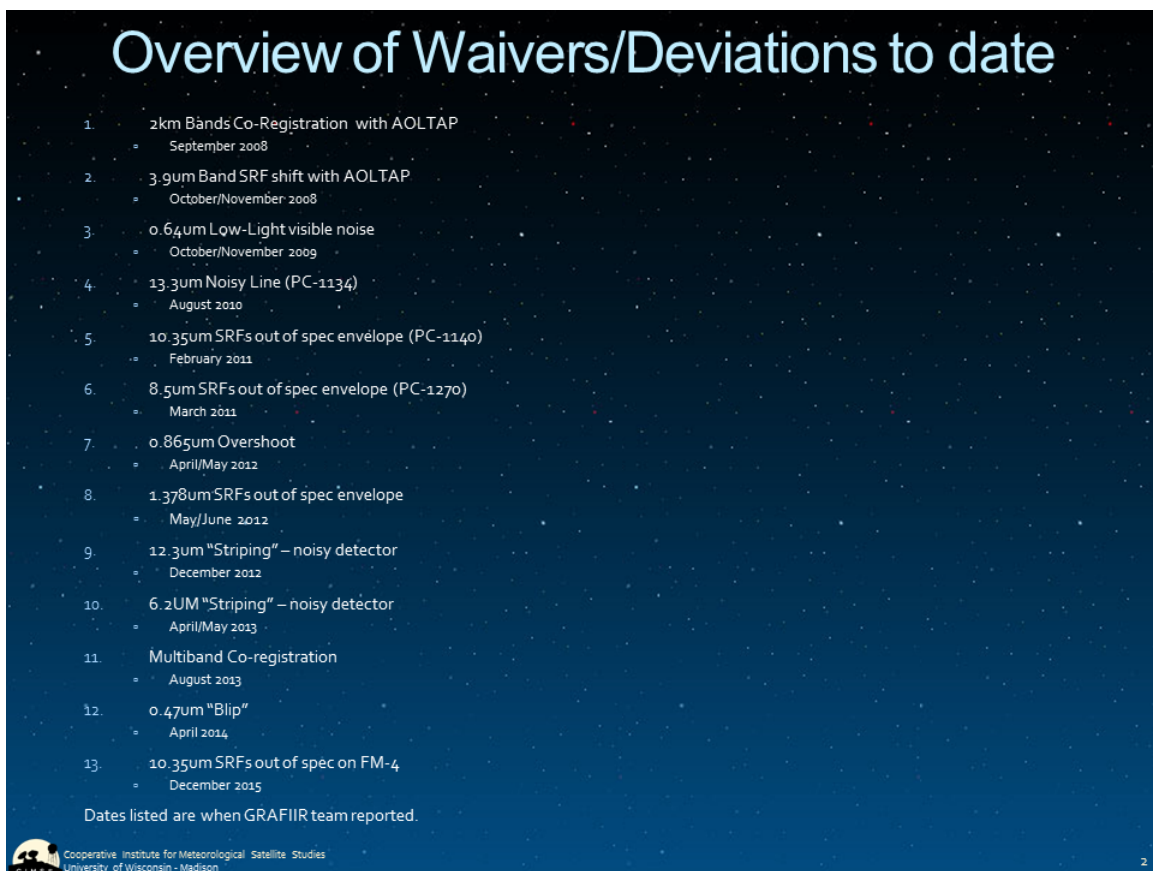

Figure 6. A list of all ABI waivers addressed by the GRAFIIR program through 2015.

#### 4.3 Algorithm Integration Team Technical Support

CIMSS Task Leader: R. Garcia

CIMSS Support Scientists: G. Martin, E. Schiffer, W. Straka





**NOAA Collaborators: M. Pavolonis, W. Wolf**  
**Budget: \$326K**

**NOAA Long Term Goals:**

- Weather-Ready Nation

**NOAA Strategic Goals:**

- Provide critical support for the NOAA mission

**CIMSS Research Themes:**

- Satellite Meteorology Research and Applications
- Satellite Sensors and Techniques

**Objective**

Provide integration and technical support for the GOES-R Algorithm Working Group teams at CIMSS.

**Project Overview**

The AIT-Midwest handles aspects of computer science cross-cutting AWG algorithm development teams at CIMSS/SSEC, and works in cooperation with the AIT-East in Washington, DC. This includes software development practices, software process management, documentation, testing and automation, infrastructure, general computing assistance, and systems design and optimization.

**Principal Activities:**

- Profile reference algorithm implementations and explore performance, accuracy, and reproducibility improvements.
- Review and update software and deliverables with CIMSS science staff.
- Maintained expanded, and deployed verification and automation test tools in coordination with GRAFIIR and AIT-East.
- Provide guidance to science staff as needed to improve computer science aspects of algorithm reference software.
- Continued refactoring and migration of science software toward framework- and platform- agnostic software interfaces in order to simplify existing code and provide new avenues for rapid algorithm development.
- Added Himawari-8 (AHI) processing capability to algorithm development environment software (Geocat, CLAVR-X) as a proxy for ABI.
- Work with proxy team to integrate additional proxy input into reference/test science software.
- Continued research/offline framework developments and common satellite library development.
- Test integration work in cooperation with visualization group and AIT-East.
- CIMSS/SSEC infrastructure maintenance in support of AWG algorithm work and Cal/Val.
- Feedback and technical interchange with AIT-East and Harris/AER regarding computer science concerns in algorithm implementations and operational framework interfaces.



## Milestones with Summary of Accomplishments and Findings

- Continued work on integration and verification testing of updated CIMSS reference algorithms in SAPF (STAR Algorithm Processing Framework) for use at NOAA.
- Improvements to Glance verification toolset, responding to AWG and AIT-E team requests and objectives.
- Participated in GOES-R Algorithm Test Tools (ATT) alpha release training.
- Successfully ported and ran ATT locally at CIMSS.
- Supported Harris test product verification, providing necessary feedback. This included support the GOES-R Ground Segment Project with the verification of the Level-2 product output generated by the GOES-R Ground Segment Contractor (Harris), as well as familiarization and review of Level-2 product software developed by the GOES-R Ground Segment Contractor (Harris / AER).
- Performed preliminary assessment of Harris/AER operational code algorithm samples.
- SAPF workflow improvements to improve speed of algorithm integration and testing work.
- Continued work on extracting sharable functionality in Geocat to external libraries usable by SAPF, CLAVR-X et al including ingest, calibration, navigation and numerical utilities.
- Authored C/Fortran/Python callable toolbox used for algorithm development systems to access Himawari Standard Data format, permitting imagery and Level 2 algorithms to be tested shortly after the availability of AHI near-real-time data.
- Integration of libHimawari into GEOCAT, and rapid NetCDF transcoding capability provided for imagery and CLAVR-X rapid validation using AHI data.
- Technical and product feedback for AHI provided to JMA through NOAA channels.
- Retained and distributed test and ancillary datasets in support of AWG deliverables.
- Provide guidance and assistance to science staff as needed to improve computer science aspects of algorithm reference software. This included CIMSS/SSEC infrastructure maintenance in support of AWG algorithm work and Cal/Val.
- Increased involvement in AIT reference framework development and maintenance.
  - This includes CIMSS configuration management, build and execution automation for the SAPF. This will provide routine local processing of the SAPF from proxy and simulation datasets specifically for CIMSS AWG uses.
  - Preliminary integration activities for CIMSS algorithm updates for delivery to AIT-East also to be included.
- Collaboration and directed research on SAPF improvements, including modularity and reuse improvements, new features to support increased accuracy or performance, code and documentation review.
- Management and coordination of schedules, deliveries, software configuration items in cooperation with AWG and Harris/AER.

### 4.4 GOES-R Collocation

**CIMSS Task Leader: Robert Holz**

**CIMSS Support Scientists: Greg Quinn, Ralph Kuehn, Fred Nagle, and Alexa Ross**

**NOAA Collaborators: Walter Wolf and Jaime Daniels**

**Budget: \$75K**

### NOAA Long Term Goals:

- Climate Adaptation and Mitigation
- Weather-Ready Nation



### **NOAA Strategic Goals:**

- Provide critical support for the NOAA mission

### **CIMSS Research Themes:**

- Satellite Sensors and Techniques

### **Objective**

The main objective of the GOES-R collocation project is to provide a comprehensive evaluation infrastructure in support of the GOES-R product development and post launch validation.

### **Project Overview**

This report provides an overview of the GOES-R collocation project accomplishments with a focus on how the project is supporting the GOES-R AWG teams. The project leverages decades of experience in applying vector algebra and analytic geometry to problems in satellite navigation and collocation at CIMSS. This capability originated in the 1970's as part of the NOAA satellite group lead by Bill Smith Sr. and Fred Nagle to help support the early NOAA polar and geostationary instruments. As will be presented, the GOES-R AWG project has provided the support to greatly expand these tools to support the AWG calibration and validation efforts enabling months or years of data to quickly be collocated and compared for statistical analysis and long term monitoring. As part of the GOES-R AWG effort, the collocation project supports the following goals:

- Develop a maintainable and extensible toolkit capable of orbital analysis (overpass calculations for satellite-to-satellite or satellite-to-ground) and pixel-to-pixel collocation for both GEO and LEO instruments. This effort involves development of new techniques and algorithms in addition to refactoring and organizing legacy code.
- Support the collocation needs of GOES-R AWG teams as they work to validate their algorithms. The collocation toolkit will become part of a standard validation framework being developed by the AIT.
- Leverage the collocation tools to build an inter-calibration system to allow near real-time monitoring of instrument performance and long-term analysis of radiometric trends.

Both the inter-calibration and validation features have been integrated into a system that allows for near real-time processing using a compute cluster. Thus as instrument data is made available, inter-calibration data or validation results can be made available within hours.

### **Milestones with Summary of Accomplishments and Findings**

This is the fifth year of funding under the GOES-R program. Accomplishments to date include:

- Developed collocation software for the GOES and AMV wind retrievals;
- Processed a 7 year record of GOES AMV winds and collocated CALIOP cloud products and delivered the results to the winds team;
- AHI collocation software for CALIPSO, MODIS, and JPSS (VIIRS/CrIS) has been implemented and tested;
- AHI/ABI processing system upgraded to support the new collocation and matchup software. Developed GEO-LEO collocations including JPSS CrIS and VIIRS observations; and
- Developing a new web interface to visualize and distribute the validation products to the GOES-R validation teams with an example presented of the cloud top height validation presented in Figure 7.

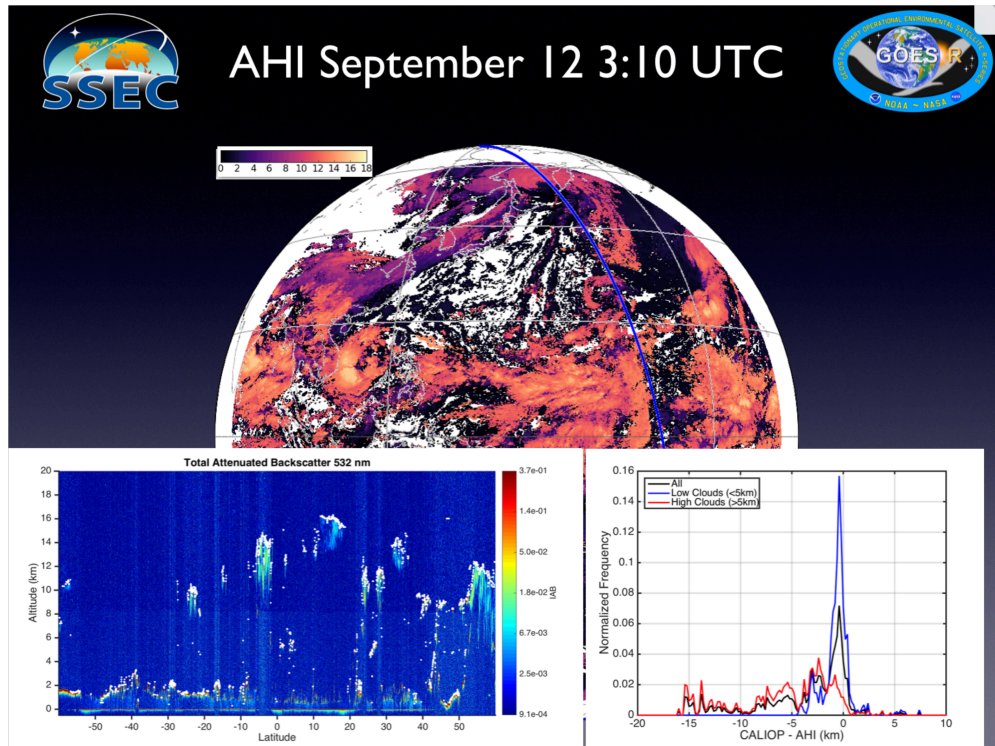

Figure 7. The enterprise GOES-R cloud top height applied to AHI observations is presented in the top figure. Collocated CALIPSO inter-comparisons are presented at the bottom of the image. The white dots in the CALIOP attenuated backscatter profile (bottom left) are the collocated GOES-R cloud top results. The bottom right figure presents the distribution of cloud top height differences between CALIOP and AHI.

#### 4.5 ABI Cloud Products

**CIMSS Task Leader: William Straka III**

**CIMSS Support Scientists: Steve Wanzong, Andi Walther, Pat Heck**

**NOAA Collaborators: Andrew Heidinger, Michael Pavolonis**

**Budget: \$231,000**

#### NOAA Long Term Goals:

- Weather-Ready Nation

#### NOAA Strategic Goals:

- Serve society's needs for weather and water
- Support the nation's commerce with information for safe, efficient and environmentally sound transportation
- Provide critical support for the NOAA mission

#### CIMSS Research Themes:

- Satellite Meteorology Research and Applications
- Satellite Sensors and Techniques

#### Objective

To develop a suite of products that offers advanced cloud detection and cloud property retrievals using the ABI.



## **Project Overview**

The National Environmental Satellite, Data, and Information Service, Center for Applications and Research (NESDIS/STAR) and the Cooperative Institute for Meteorological Satellite Studies (CIMSS) have been developing a suite of products that will offer advanced cloud detection and retrievals of cloud properties utilizing the GOES-R ABI instrument. The Cloud AWG has developed five algorithms that generate fourteen independent cloud products. These include the clear sky mask, cloud type and phase, cloud top height, cloud top pressure, cloud top temperature, and both day and nighttime cloud microphysical properties.

## **Milestones with Summary of Accomplishments and Findings**

The focus of the Cloud AWG this reporting period was maintaining and updating the various algorithms, validating the updated algorithms and supporting the GOES-R Ground Segment System Prime, Harris Corporation, in their implementation of the cloud algorithms.

The various cloud algorithms have been, or are in the process of, being adapted for sensors other than ABI. These include the current GOES sensors, COMS, Himawari-8 (ABI like imager), Meteosat, MTSAT, MODIS, VIIRS as well as making sure that the baseline algorithms work on the simulated ABI datasets. This will ensure that the algorithms will be fully tested and validated prior to the launch of GOES-R and the ABI instrument.

Validation of the current and updated algorithms is important to ensure the algorithms perform as expected once GOES-R launches. The Cloud AWG has extensively used other satellite sensors, such as spaceborne lidars, (CALIPSO), passive microwave satellite sensors (AMSU, AMSR-E), ground based lidars (HRSL), ground microwave profilers (MWR at ARM site) and passive imagers (MODIS, AVHRR), as independent validation data sources. In addition, the Cloud AWG has made extensive use of the lidar on-board CALIPSO to tune the cloud mask for the least number of false detections. The Cloud AWG team also continues to work with the other Algorithm Working Groups, such as the Derived Motion Winds AWG, as well as other groups to continue to validate and improve the algorithms. The cloud algorithms were also used as part of EUMETSAT Cloud Retrieval Evaluation Workshop (CREW), where the Cloud AWG algorithms were compared with algorithms from other institutions. Automated validation tools were also worked on in the previous year so that there can be automatic validation of the various cloud algorithms after launch.

In addition to offline validation studies, the cloud algorithms have been used in a near-realtime field campaigns as well as international workshops on cloud properties. For example, the cloud top height algorithm, which also relies on the cloud mask and type/phase algorithms, will be used during NOAA Shout Program (Sensing Hazards with Operational Unmanned Technology). Cloud heights are used to aid in flight path decisions for the Global Hawk Unmanned Aerial Vehicle (UAV) over and around the path of tropical cyclones. Figure 8 shows how post processing comparisons between cloud height and CALIPSO allow the HS3 team confidence in the product. In addition, the cloud algorithms are also being used as part of the University of Alabama, Huntsville Convective Initiation algorithm, in near-realtime, which is discussed in section 5.4 of this report.

As mentioned, the Cloud AWG continues to support the GOES-R Ground Segment (GS) System Prime, Harris Corporation, in their implementation of the cloud algorithms. The GS released their first output of the cloud algorithms in November 2013, where several issues were noticed. Along with the Algorithm Integration Team, Midwest (AIT-MW) at CIMSS, the Cloud AWG passed along comments and analysis to help improve the GS.

In 2015, the Cloud AWG continued to improve the various cloud algorithms, support the GS in their effort as they produce output from the baseline cloud algorithms, continue development on the automated tools for the validation of the cloud algorithm, support international validation efforts and continue support of near-realtime usage of the cloud algorithms by field campaigns. In addition, the cloud team evaluated both the baseline and updated algorithms using the Advanced Himawari Imager (AHI), a ABI-like instrument currently onboard the Japanese Meteorological Agency's Himawari-8 geostationary satellite. This will prepare the team for the launch of GOES-R in 2016. During this reporting period, AHI cloud products will be used in the KORUS-AQ field campaign (Korea, US Air Quality). CIMSS supplied several cloud products, including: cloud top altitude, cloud water path, dust-rgb, cloud mask, cloud type, and true color. Figure 9 shows an example of the true color images over the KORUS domain. In addition, this will provide information on possible post-launch improvements for each algorithm.

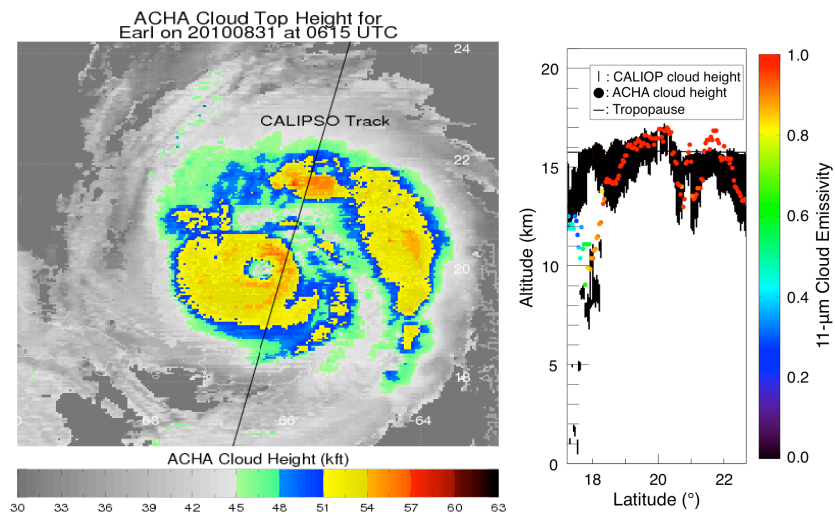

**Figure 8. Post hurricane analysis of category 4 Hurricane Earl comparing ACHA cloud heights with CALIPSO. ACHA cloud heights match CALIPSO well in the convective eyewall and outer band.**

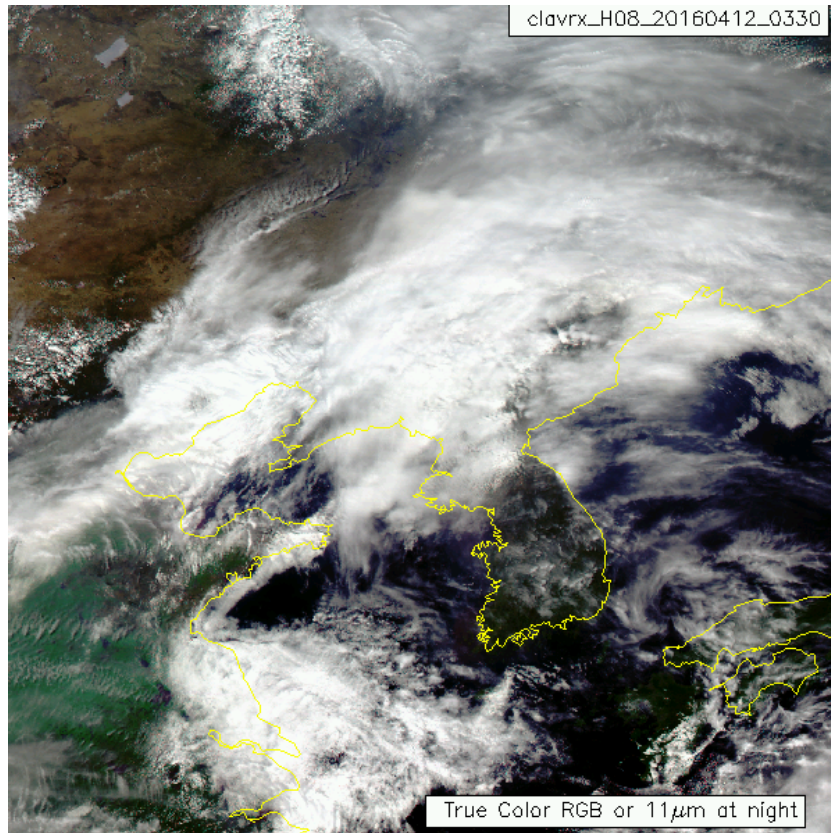

Figure 9. Example AHI true color RGB over the KORUS-AQ domain from April 12, 2016 at 0330 UTC. This is just one of several products supplied by the Cloud AWG team.

### Publications and Conference Reports

Feltz, Wayne; Pierce, R. Bradley; Eloranta, Ed; Schmidt, Sebastian; Heidinger, Andrew; Kondragunta, Shobha; Walther, Andi and LeBlance, Samuel. GOES-R cloud and aerosol validation during the NSF DC3 field mission. NOAA 2013 Satellite Conference for Direct Readout, GOES/POES, and GOES-R/JPSS Users, College Park, MD, 8-12 April 2013. NASA, Goddard Space Flight Center, GOES-R Program Office, Greenbelt, MD, 2013, poster presentation.

Hamann, U.; Walther, A.; Baum, B.; Bennartz, R.; Bugliaro, L.; Derrien, M.; Francis, P. N.; Heidinger, A.; Joro, S.; Kniffka, A.; Le Gleau, H.; Lockhoff, M.; Lutz, H.-J.; Meirink, J. F.; Minnis, P.; Palikonda, R.; Roebeling, R.; Thoss, A.; Platnick, S.; Watts, P. and Wind, G.. Remote sensing of cloud top pressure/height from SEVIRI: Analysis of ten current retrieval algorithms. *Atmospheric Measurement Techniques*, Volume: 7, Issue: 9, 2014, pp.2839-2867

Heidinger, Andrew. Algorithm Theoretical Basis Document: ABI cloud height. Version 2.0. NOAA, NESDIS, Center for Satellite Applications and Research, 2011.

Heidinger, Andrew. Algorithm Theoretical Basis Document: ABI cloud mask. Version 2.0. NOAA, NESDIS, Center for Satellite Applications and Research, 2011.

Heidinger, Andrew K.. Applicability of GOES-R AWG cloud algorithms for JPSS/VIIRS. Annual Symposium on Future Operational Environmental Satellite Systems, 7th, Seattle, WA, 23-27 January 2011. American Meteorological Society (AMS), Boston, MA, 2011, abstract only.



Heidinger, Andrew K.. Performance of the NOAA AWG cloud height algorithm applied to current geostationary and polar orbiting imagers. International Winds Workshop, 12th, Copenhagen, Denmark, 15-20 June 2014. University of Copenhagen, Copenhagen, Denmark, 2014, abstract only.

Heidinger, Andrew K.; Evan, Amato T.; Foster, Michael J. and Walther, Andi. A naive Bayesian cloud-detection scheme derived from CALIPSO and applied within PATMOS-x. *Journal of Applied Meteorology and Climatology*, Volume: 51, Issue: 6, 2012, pp.1129-1144.

Heidinger, Andrew K.; Wanzong, S. and Walther, A.. Analysis of convective clouds viewed from GOES during DC3. Conference on Severe Local Storms, 27th, Madison, WI, 2-7 November 2014. American Meteorological Society, Boston, MA, 2014, abstract only.

Heidinger, Andrew; Baum, Brian and Roebeling, Rob. The Cloud Retrieval Evaluation Workshop (CREW). Meeting on the Intercomparison of Satellite-based Volcanic Ash Retrieval Algorithms within WMO SCOPE-Nowcasting, Madison, WI, 28 June-2 July 2015. University of Wisconsin-Madison, Space Science and Engineering Center, Madison, WI, 2015, PowerPoint presentation.

Heidinger, Andrew; Pavolonis, Michael; Walther, Andi; Heck, Pat; Minnis, Pat and Straka, William. GOES-R AWG product validation tool development: Cloud products. GOES-R AWG Annual Meeting, Fort Collins, CO, 14-16 June 2011. NASA, Goddard Space Flight Center, GOES-R Program Office, Greenbelt, MD, 2011.

Heidinger, Andrew; Walther, Andi; Foster, Mike and Ackerman, Steve. State of the NOAA AWG cloud algorithms. 2011 EUMETSAT Cloud Retrieval Evaluation Workshop, 3rd, (CREW-3), Madison, WI, 15-18 November 2011. University of Wisconsin-Madison, Space Science and Engineering Center, Cooperative Institute for Meteorological Satellite Studies (CIMSS), Madison, WI, 2011, abstract only.

Heidinger, Andrew; Wanzong, Steve and Walther, Andi. Status of cloud products from HIMAWARI-8 AHI. 2015 GOES-R/JPSS OCONUS Satellite Proving Ground Technical Interchange Meeting, Anchorage, AK, 12-15 May 2015. National Oceanic and Atmospheric Administration (NOAA), 2015.

Kelly, Michael; Wu, Dong; Yee, Jeng-Hwa; Boldt, John; Demajistre, Robert; Reynolds, Edward; Tripoli, Gregory; Oman, Luke; Prive, Nikki; Heidinger, Andrew and Wanzong, Steve. C3Winds: A novel 3D wind observing system to characterize severe weather events. AGU Fall Meeting, San Francisco, CA, 14-18 December 2015. American Geophysical Union, Washington, DC, 2015, abstract only; Abstract A51G-0150.

Kinne, Stefan; Stubenrauch; Rossow, W. B.; Pearl, C.; Heidinger, A.; Walther, A.; Guignard, A.; Ackerman, S.; Platnick, S.; Maddux, B.; Minnis, P.; Sun-Mack, S.; DiGirolamo, L.; Menzies, A.; Menzel, P.; Olsen, E.; Riedi, J.; Zeng, S.; Winker, D.; Getzewich, B.; Chepfer, H.; Gesana, G.; Poulsen, C. and Sayer, A.. GEWEX cloud assessment: A review. 2011 EUMETSAT Cloud Retrieval Evaluation Workshop, 3rd, (CREW-3), Madison, WI, 15-18 November 2011. University of Wisconsin-Madison, Space Science and Engineering Center, Cooperative Institute for Meteorological Satellite Studies (CIMSS), Madison, WI, 2011, abstract only.

Madani, Houria; Carr, James; Heidinger, Andrew and Wanzong, Steve. Inter-comparisons





between radiometric and geometric cloud top height products. AGU Fall Meeting, San Francisco, CA, 14-18 December 2015. American Geophysical Union, Washington, DC, 2015, abstract only; Abstract A33E-0220.

Mecikalski, John R.; Jewett, C. P.; Weygandt, S.; Smith, T. L.; Heidinger, A. K.; Straka, W. and Benjamin, S.. Convective initiation of 0-6 hr storm nowcasting for GOES-R. Conference on Weather Analysis and Forecasting, 26th, and Conference on Numerical Weather Prediction, 22nd, Atlanta, GA, 2-6 February 2014. American Meteorological Society, Boston, MA, 2014, abstract only.

Monette, Sarah A.; Velden, C. S.; Heidinger, A. K.; Zipser, E. J.; Cecil, D. J.; Black, P. G. and Braun, S. A.. Validation of Automated Cloud Height Algorithm (ACHA) cloud top heights in tropical cyclones using observations from the NASA Global Hawk. Conference on Hurricanes and Tropical Meteorology, 31st, San Diego, CA, 31 March-4 April 2014. American Meteorological Society, Boston, MA, 2014, abstract only.

Roebeling, R.; Baum, B.; Bennartz, R.; Hamann, U.; Heidinger, A.; Thoss, A. and Walther, A.. Outcome of the Third Cloud Retrieval Evaluation Workshop. IRS 2012: International Radiation Symposium, Berlin, Germany, 6-10 August 2012. Radiation Processes in the Atmosphere and Ocean (IRS2012). American Institute of Physics, Melville, NY, 2013, pp.416-419. Reprint # 7142.

Roebeling, R.; Baum, B.; Bennartz, R.; Hamann, W.; Heidinger, A.; Melrinc, J. F.; Stengel, M.; Thoss, A.; Walther, A. and Watts, P.. Outcome of the fourth Cloud Retrieval Evaluation Workshop. 2014 EUMETSAT Meteorological Satellite Conference, Geneva, Switzerland, 22-26 September 2014. Abstracts. European Organization for the Exploitation of Meteorological Satellites (EUMETSAT), Darmstadt, Germany, 2014, abstract only.

Roebeling, Rob; Baum, Bryan; Bennartz, Ralf; Hamann, Ulrich; Heidinger, Andy; Thoss, Anke and Walther, Andi. Evaluating and improving cloud parameter retrievals. *Bulletin of the American Meteorological Society*, Volume: 94, Issue: 4, 2013, ES41-ES44.

Roebeling, Rob; Baum, Bryan; Bennartz, Ralf; Hamann, Ulrich; Heidinger, Andrew; Meirink, Jan Fokke; Stengle, Martin; Thoss, Anke; Walther, Andi and Watts, Phil. Summary of the fourth Cloud Retrieval Evaluation Workshop. *Bulletin of the American Meteorological Society*, Volume: 96, Issue: 4, 2015, ES71-ES74.

Schmit, Timothy J.; Goodman, Steven J.; Gunshor, Mathew M.; Sieglaff, Justin; Heidinger, Andrew K.; Bachmeier, A. Scott; Linstrom, Scott S.; Terborg, Amanda; Feltz, Joleen; Bah, Kaba; Rudlosky, Scott; Lindsey, Daniel T.; Rabin, Robert M. and Schmidt, Christopher C.. Rapid refresh information of significant events: Preparing users for the next generation of geostationary operational satellites. *Bulletin of the American Meteorological Society*, Volume: 96, Issue: 4, 2015, pp.561-576, supplement

Schreiner, Anthony J.; Menzel, W. Paul; Straka, William and Heidinger, Andrew. Comparison of CO<sub>2</sub> and H<sub>2</sub>O Atmospheric Motion Vector height assignment techniques using the GOES-13 imager. International Winds Workshop, 11th, Auckland, New Zealand, 20-24 February 2012. EUMETSAT, Darmstadt, Germany, 2012.

Schreiner, Anthony; Menzel, W. Paul; Straka, William and Heidinger, Andy. Comparing



CO<sub>2</sub>/IRW and H<sub>2</sub>O/IRW CTPs. International Winds Workshop, 11th, Auckland, New Zealand, 20-24 February 2012.

Walther, A. and Heidinger, A. K.. The consistency of cloud climatologies derived from several sensors. AGU Fall Meeting, San Francisco, CA, 5-9 December 2011. American Geophysical Union, Washington, DC, 2011, abstract only; Abstract A13B-0275.

Walther, Andi and Heidinger, A.. The Daytime Cloud Optical and Microphysical Properties (DCOMP) algorithm. Conference on Satellite Meteorology, Oceanography and Climatology, 18th, and Joint AMS-Asia Satellite Meteorology Conference, 1st, New Orleans, LA, 22-26 January 2012. American Meteorological Society, Boston, MA, 2012, abstract only.

Walther, Andi and Heidinger, Andrew K.. Implementation of the Daytime Cloud Optical and Microphysical Properties algorithm (DCOMP) in PATMOS-x. *Journal of Applied Meteorology and Climatology*, Volume: 51, Issue: 7, 2012, pp.1371-1390.

Walther, Andi; Heidinger, Andrew and Park, Chang-Hwan. Sources of error in satellite derived cloud products. 2011 EUMETSAT Cloud Retrieval Evaluation Workshop, 3rd, (CREW-3), Madison, WI, 15-18 November 2011. University of Wisconsin-Madison, Space Science and Engineering Center, Cooperative Institute for Meteorological Satellite Studies (CIMSS), Madison, WI, 2011, abstract only.

Walther, Andi; Straka, William and Heidinger, Andrew K.. Advanced Baseline Imager (ABI) Algorithm Theoretical Basis Document for Daytime Cloud Optical and Microphysical Properties (DCOMP) Version 2.0. NOAA, NESDIS, Center for Satellite Applications and Research, 2011

#### **4.6 Active Fire/Hot Spot Characterization**

**CIMSS Task Leader: Chris Schmidt**

**CIMSS Support Scientists: Jay Hoffman, Elaine Prins (UW-Madison/CIMSS-Contractor)**

**NOAA Collaborators: Yunyue Yu (NOAA/NESDIS/STAR), Ivan Csiszar (NOAA/NESDIS/STAR)**

**Budget: \$80K**

##### **NOAA Long Term Goals:**

- Climate Adaptation and Mitigation
- Weather-Ready Nation

##### **NOAA Strategic Goals:**

- Understand climate variability and change to enhance society's ability to plan and respond
- Support the nation's commerce with information for safe, efficient and environmentally sound transportation
- Provide critical support for the NOAA mission

##### **CIMSS Research Themes:**

- Satellite Meteorology Research and Applications
- Satellite Sensors and Techniques



## Objective

To provide fire detection and characterization by implementing and validating the Wildfire Automated Biomass Burning Algorithm with the GOES-R ABI sensor.

## Project Overview

This effort has adapted the current Global Wildfire Automated Biomass Burning Algorithm (WFABBA) to GOES-R ABI. This activity has been building on historical and current expertise at CIMSS in fire algorithm development for the GOES Imager and the global geostationary fire observation network (MSG, MTSAT, COMS, etc). CIMSS revised the WFABBA to address GOES-R ABI observational requirements utilizing the improved fire monitoring capabilities on GOES-R. This work included updating modules that identify and characterize sub-pixel fire activity, demonstrating and validating the prototype GOES-R ABI Fire Detection and Characterization Algorithm (FDCA) using various GOES-R ABI proxy data sets, and providing a version of the algorithm for further evaluation by the AWG science team. This effort includes collaboration with MODIS and NPOESS VIIRS fire product development experts to maximize future use of multiple data sources (geo and leo) that take advantage of the strengths of each system to create improved fused fire products. The collaboration also has led to the development of innovative “deep-dive” validation tools. This activity will ensure enhanced future geostationary fire detection, diurnal monitoring, and characterization in the GOES-R era. The validation component of this work is performed in conjunction with Dr Wilfrid Schroeder from CICS.

## Milestones with Summary of Accomplishments and Findings

The FY15 milestones for CIMSS were:

- Maintenance update(s) to fire algorithm using pre-launch test samples based on AHI input data
- Perform pre-launch routine validation tests using AHI input data
- Draft paper on ABI fire algorithm and proxy data
- Support AIT and/or ground system contractor with Level 2 fire product verification; exercise/demonstrate the corresponding fire validation tools

The expenditure period for this project encompassed July 2015 through March 2016. Work primarily consisted of testing with AHI data, continued development of validation software, support for AIT and the ground system contractor with respect to algorithm implementation, and outreach at the AMS Annual Meeting during the GOES-R Short Course.

Testing with AHI data began in 2015. Initial examination of an active fire day over Sumatra on 24 September 2015 showed strong agreement between MODIS Aqua fire detections and the FDCA at 3:15 UTC and 3:20 UTC respectively, as shown in Figure 10. Not included in the domain was a region of intense fires within the smoke pall that the FDCA picked up but was missed by the MODIS Collection 6 algorithm due to the high reflectivity of the smoke. Performance during periods of high solar insolation over Australia and Southeast Asia was found to be problematic, however, with a large number of false alarms present. The region presents a somewhat unique challenge given the extreme surface temperatures, which challenges assumptions that have been in place in the algorithm since it was first developed. Various approaches are being tested to mitigate the false alarms. The most promising approach, which would result in somewhat substantial algorithm changes, is to use a more rigorous solar correction that is possible due to the higher quality emissivity values available today. Additionally, a bug was discovered in the algorithm, a hold-over from its heritage algorithm, the



WFABBA. The bug, which notably impacted fire detections, was corrected in the CIMSS version of the FDCA and the correction will be delivered to the AIT.

The validation software for the FDCA is composed of two components, routine and deep-dive validation. The deep-dive validation software is being primarily developed by Dr Wilfrid Schroeder at CICS, with participation from CIMSS, and utilizes high resolution (Landsat class) data to validate fire detections by lower resolution satellites, such as current GOES, MODIS, and VIIRS. This deep-dive tool can provide precise location and size information, though not temperature or fire radiative power. It allows some assessment of omission and commission errors on the part of the FDCA. CIMSS has been working the Dr Schroeder on developing the tool and providing reference data for testing. The routine validation process consists of visual comparison between various satellite sources of fire data for what amounts to a sanity check of the FDCA data. The performance of the FDCA will be assessed by comparing the fire location data to other available sources, such as polar orbiting platforms using visualization software (IDL, Google Earth, McIDAS-V, etc) that can display multiple datasets simultaneously; web-based mapping tools like SSEC's RealEarth will be the primary tools as they can function through a web browser. This tool won't assess performance for false alarms, missed detections, and fire characteristics as the deep-dive tool does.

Support was provided to the AIT and AWG through editing of the RIMP and the creation of the validation plan. No L2 data with fires output was available during the project period.

Outreach for the FDCA (and WFABBA) once again occurred at a GOES-R Short Course, this one held at the AMS Annual Meeting in New Orleans in January 2016. The basic science of the algorithm and outputs, including GOES-14 1-minute data, were presented to a mixed audience of researchers and educators.



Figure 10. FDCA fire detections from Himawari-8 AHI data over Sumatra at 3:20 UTC on 24 September 2015 overlaid on MODIS Aqua imagery and fire data from 3:15 UTC. MODIS fires are red polygons, FDCA fires are red, magenta, and cyan colored targets. The two instruments agree well. This data was created before the bug affecting detections was fixed.

#### Publications and Conference Reports

Schmidt, C. C., *Finding Fires: The Next Generation*, 12th Annual Symposium on New Generation Operational Environmental Satellite Systems at the 96th American Meteorological Society Annual Meeting, New Orleans, LA, 9-14 January 2016. American Meteorological Society, Boston, MA, 2016.

#### 4.7 GOES-R Legacy Atmospheric Profile, Total Precipitable Water (TPW) and Atmospheric Instability Indices

CIMSS Task Leader: Jun Li

CIMSS Support Scientists: Yong-Keun Lee, Zhenglong Li, Richard Dworak, Jordan Gerth, Jim Nelson and Bill Bellon



**NOAA Collaborator: Tim Schmit**  
**Budget: \$218,000**

**NOAA Long Term Goals:**

- Climate Adaptation and Mitigation
- Weather-Ready Nation

**NOAA Strategic Goals:**

- Serve society's needs for weather and water
- Understand climate variability and change to enhance society's ability to plan and respond
- Provide critical support for the NOAA mission

**CIMSS Research Themes:**

- Satellite Meteorology Research and Applications

**Objective**

The objective is to develop legacy atmospheric profile, Total Precipitable Water (TPW) and atmospheric instability indices from GOES-R ABI for weather forecast applications.

**Project Overview**

The main focus of this project is to develop the legacy atmospheric profile (LAP) algorithm for the next generation Geostationary Operational Environmental Satellite (GOES-R) Advanced Baseline Imager (ABI) (Schmit et al. 2005) product generation. The algorithm retrieves atmospheric temperature and moisture profiles and the derived products including total precipitable water (TPW), layer precipitable water (PW), lifted index (LI), convective available potential energy (CAPE), total totals index (TT), Showalter index (SI), and the K-index (KI) from the clear sky infrared (IR) radiances within a 5 by 5 ABI field-of-view (FOV) box area. This project requires CIMSS scientists to develop the GOES-R LAP algorithm to be able to process high temporal and spatial resolution ABI data efficiently. This project provides science codes to the GOES-R algorithm integration team (AIT) for algorithm integration and helps the system provider to implement the algorithm and prototype codes into the GOES-R ground system. CIMSS scientists will also evaluate and validate the GOES-R LAP algorithm to assure that the GOES-R legacy atmospheric temperature and moisture profiles, TPW, LI, CAPE, TT, SI and KI products meet the science requirements and operational applications.

**Milestones with Summary of Accomplishments and Findings**

***GOES-R LAP Algorithm Applied Successfully to Process AHI IR Radiance Measurements (July – October 2015)***

The retrieval processing package is now being running in Near Real Time (NRT) at CIMSS, and hourly AHI LAP products with 10 km resolution are now available in NRT. The Advanced Himawari Imager (AHI) onboard the Himawari-8 has the similar IR bands of ABI; CIMSS sounding team have applied the all-weather LAP algorithms to process ABI also, and the LAP product generation from AHI in NRT at CIMSS now. The algorithms include: (a) The CRTM is used for radiative transfer model in clear skies; (b) Training data covering AHI are used to update the regression coefficients and the eigenvectors for presenting the atmospheric temperature and moisture profiles in the physical retrieval process; (c) Simply cloud detection schemes including thresholds from observed minus calculated brightness temperatures (O – C) are used for identifying clear and cloudy skies; (d) The GOES-R AWG LAP algorithm is applied to derive



AHI temperature and moisture profiles in clear skies; (e) The inputs include AHI brightness temperatures, and GFS forecasts (could be other NWP model forecasts) and other ancillary data such as CIMSS surface IR emissivity database, while the outputs include the atmospheric temperature and moisture profiles, TPW and 3 layered PW (LPW), atmospheric instability indices, cloud-top pressure, cloud optical thickness, and the retrieval quality flags.

The LAP products from AHI are generated in NRT at CIMSS hourly with 10 km spatial resolution. The AWG cloud team algorithm will also be implemented for clear/cloudy identification in January 2016. The LAP products from AHI have been put into AWIPS-II now so that forecasters can access in NRT for PG applications in west Pacific Ocean regions.

Initial validation against ECMWF analysis indicates that the accuracy and precision meet the requirements, more validations are ongoing. Figure 11 shows one example of TPW from AHI (upper left), the retrieval flag (clear retrievals, cloudy retrievals and GFS) (upper right panel), along with the scatterplot between AHI and ECMWF TPWs at 00 UTC on 06 July 2015.

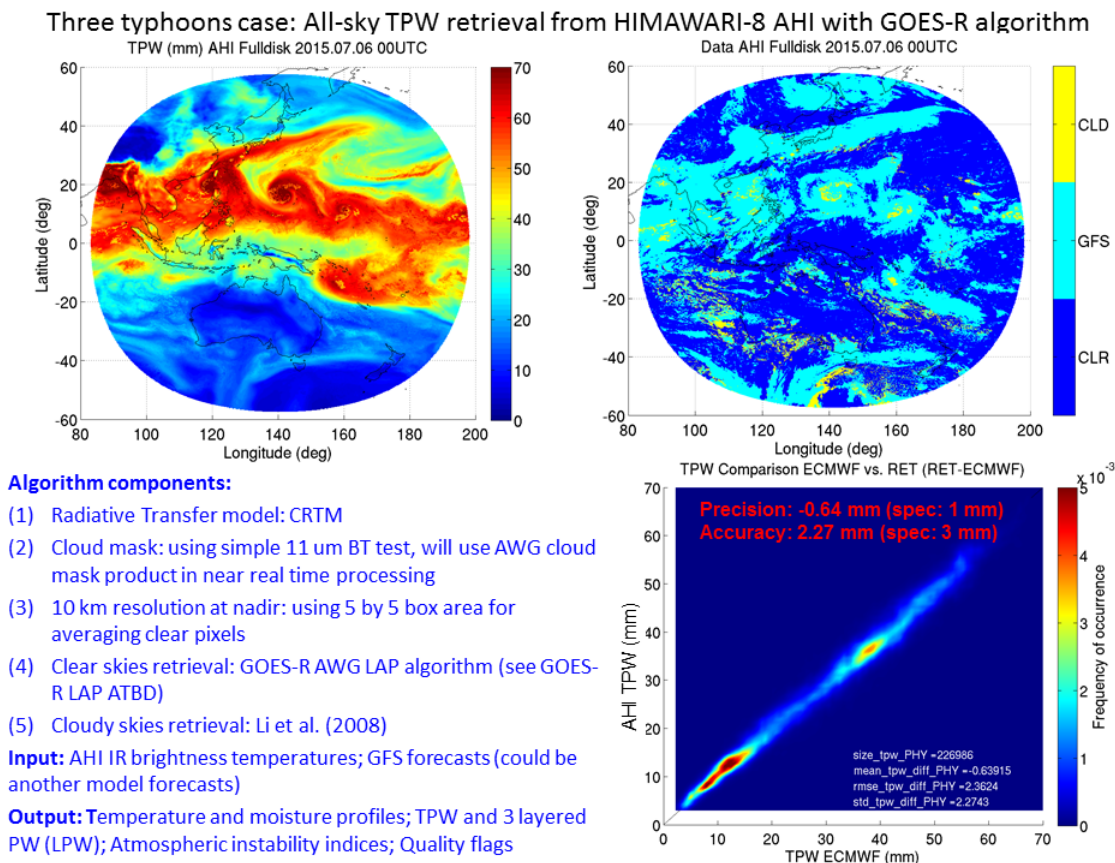

**Figure 11.** One example of TPW from AHI (upper left), the retrieval flag (clear retrievals, cloudy retrievals and GFS) (upper right panel), along with the scatterplot between AHI and ECMWF TPWs at 00 UTC on 06 July 2015.

**Web-based Validation Tool Developed for GOES/GOES-R LAP Validation (Jul 2015 – March 2016)**

GOES-R ABI LAP validation tool has been developed based on the current GOES Sounder measurements and it can be easily applied for ABI validation, the following link is the website:



<http://soundingval.ssec.wisc.edu>

Three main layers in the validation tool:

- Imagery animations include 24-hour loop over GOES-13 and GOES-15 regions; animations can be viewed for variables including TPW, LI, CAPE, KI, SI, TT, temperature, and water vapor (100, 200, 300, 400, 500, 700, 850, and 1000 hPa). Those parameters are displayed in clear skies overlaying on the GOES Sounder 11  $\mu\text{m}$  cloudy brightness temperature image.
- Region-based plotting and visualization include daily, weekly, monthly, and seasonal statistics for GOES-13 and GOES-15 regions. TPW is compared to GPS and AMSR2 TPW. The atmospheric temperature/water vapor vertical profiles, TPW, LI, CAPE, KI, SI, and TT are compared to RAOBs.
- Station-based plotting and visualization include daily, weekly, monthly, and seasonal statistics for each GPS, RAOB, and AMSR2 measurement site over GOES-13 and GOES-15 regions. TPW is compared to GPS and AMSR2 TPW. The atmospheric temperature/water vapor vertical profiles, TPW, LI, CAPE, KI, SI, and TT are compared to RAOBs. Deep dive capability is included in the time series of each variable including TPW, LI, CAPE, KI, SI, and TT over RAOB sites. Figure 12 shows an example of region-based plotting over GOES-13 regions: the TPW (hourly) comparison to GPS measurements on 07 September 2015.

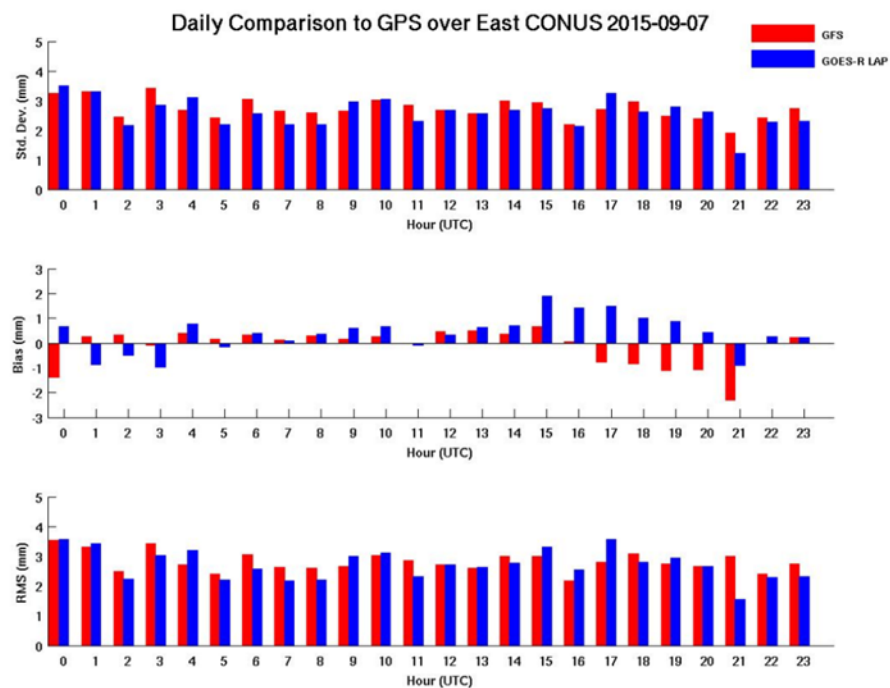

Figure 12. An example of region-based plotting over GOES-13 regions: the TPW (hourly) comparison to GPS measurements on 07 September 2015. The standard deviation (STD) is in the upper panel, the bias is in the middle panel and the RMS is in lower panel.

In the middle of 2015, CIMSS LAP team has demonstrated the validation tool to GOES-R Sounding Team Chair Tim Schmit. Tim provided very valuable suggestions and guidance on further improving the validation tool, which has been taken into account later in the refinement.





### ***Assisted Harris on Implementing LAP Algorithms in Ground System (GS), DOE Data Check, and RIMP Development (all year)***

Activities include but are not limited to: (a) Assisted AIT on Harris codes. Collaborating with GOES-R Algorithm Integration Team (Walter Wolf, Jon Wrotny, Aiwu Li et al.) on answering questions on LAP algorithms and corresponding the codes (both Harris codes and CIMSS prototype science codes); (b) Assisted DOE data check. CIMSS GOES-R LAP team helped reviewing and checks the DOE-1 and -2 datasets. Feedback and suggestions were provided to AWG management (Jaime Daniels) and GOES-R sounding team Chair (Tim Schmit); (c) Helped RIMP development. CIMSS LAP team helped the development of Validation Readiness, Implementation and Management Plan (RIMP) for atmospheric instability indices, total precipitable water etc. Feedback and suggestions are provided to Andrew K Mollner who is responsible for RIMP.

### **Publications and Conference Reports**

Lee, Yong-Keun, Jun Li, Zhenglong Li, and Timothy Schmit, 2016: Application of GOES-R ABI LAP algorithm to AHI onboard Himawari-8, 96th American Meteorological Society Annual Meeting, New Orleans, LA, 10-14 January 2016.

Wang, P., Jun Li, et al., 2015: The Impact of the High Temporal Resolution GOES/GOES-R Moisture Information on Severe Weather Systems in Regional NWP model, The 20th International TOVS Conference (ITSC-20), 28 October – 03 November 2015, Lake Geneva, Wisconsin, U.S.A.

Wang, Pei, Jun Li, Yong-Keun Lee, Zhenglong Li, Jinlong Li, Zhiqian Liu, Tim Schmit and Steve A. Ackerman, 2016: The Impact of the High Temporal Resolution GOES and GOES-R Moisture Information on Severe Weather Systems in a Regional NWP Model, 96th American Meteorological Society Annual Meeting, New Orleans, LA, 10-14 January 2016.

### **4.8 ABI Derived Motion Winds**

**CIMSS Task Leaders: Chris Velden and Steve Wanzong**

**CIMSS Support Scientist: David Stettner**

**NOAA Collaborator: Jaime Daniels (STAR)**

**Budget: \$155,000**

#### **NOAA Long Term Goals**

- Weather-Ready Nation

#### **NOAA Strategic Goals**

- Serve society's needs for weather and water
- Provide critical support for the NOAA mission

#### **CIMSS Research Themes**

- Satellite Meteorology Research and Applications
- Satellite Sensors and Techniques

#### **Objective**

Develop an automated atmospheric motion vector derivation algorithm to operate with GOES-R imagery and provide accurate wind estimates.



## Project Overview

In preparation for the launch of GOES-R, the NOAA GOES-R Algorithm Working Group (AWG) winds team is actively developing derived motion vector (DMV) derivation algorithms and using them in demonstration studies. The software is being tested in a near real-time demonstration mode using GOES-East/West, Meteosat-10 SEVIRI, and Himawari-8 AHI data as ABI proxy imagery, with the resultant DMVs validated against “truth” data sets. Other satellite data have been incorporated into the proxy dataset testing and processing; including GOES Super Rapid Scan Operations imagery. The DMV height assignment methodologies continue to be closely integrated with the developments by the AWG Cloud Team ACHA algorithm.

## Milestones with Summary of Accomplishments and Findings

Milestone 1. The DMV reprocessing effort using the GOES-R algorithms. ERA Interim model analysis fields from ECMWF for the background fields to be used were accessed from the ECMWF Meteorological Archival and Retrieval System (MARS) using a custom scriptable Python interface. In addition, software was needed for several unit conversions and missing variables (eg: finding tropopause temperature and pressure).

Milestone 2. The DOE version 1&2 L2 validation exercise was completed. Although the DMV data from Harris was problematic, we were still able to run some validation tools on the data.

## Publications and Conference Reports

Foster, M., A. Heidinger, M. Hiley, S. Wanzong, A. Walther, and D. Botambekov, 2016: PATMOS-X Cloud Climate Record Trend Sensitivity to Reanalysis Products. JRS, in review.

## 4.9 Hurricane Intensity Estimation (HIE) Algorithm

**CIMSS Task Leaders: Chris Velden and Tim Olander**

**NOAA Collaborator: Jaime Daniels (STAR)**

**Budget: \$135,000**

### NOAA Long Term Goals

- Weather-Ready Nation

### NOAA Strategic Goals

- Serve society’s needs for weather and water
- Provide critical support for the NOAA mission

### CIMSS Research Themes

- Satellite Meteorology Research and Applications
- Satellite Sensors and Techniques

## Objective

Adapt the existing operational Advanced Dvorak Technique algorithm to operate with GOES-R imagery and provide accurate tropical cyclone intensity estimates.

## Project Overview

The CIMSS Advanced Dvorak Technique (ADT, Velden and Olander 2007) was selected to be the operational Hurricane Intensity Estimation (HIE) algorithm to operate within the GOES-R framework. The HIE will provide tropical cyclone (TC) intensity estimates using the GOES-R Advanced Baseline Imager (ABI) infrared imagery. The ADT was selected due to its



longstanding use at several operational TC centers worldwide, and because of its proven record for accuracy and reliability in providing TC intensity estimates, especially where aircraft reconnaissance is not available.

### Milestones with Summary of Accomplishments and Findings

During this reporting period, CIMSS scientists focused on two primary tasks in preparation of the launch of the GOES-R satellite:

Milestone 1. Testing and adaption of the HIE parent algorithm, the Advanced Dvorak Technique, for use with higher spatial and temporal resolution imagery. This was performed through utilization of Himawari-8 imagery. To assess the impact of the higher spatial-resolution data on the ADT, parallel intensity analyses were derived in real-time utilizing MTSAT imagery and the higher spatial-resolution Himawari-8 imagery during the period when both data sets were available. In addition, a second study was performed to investigate the use of higher-temporal resolution data on the ADT algorithm. Intensity analyses using 10-minute and 30-minute imagery were compared. Examples are provided in Figure 13. Real-time comparisons are presented via the CIMSS GOES-R Proving Ground HIE webpage.

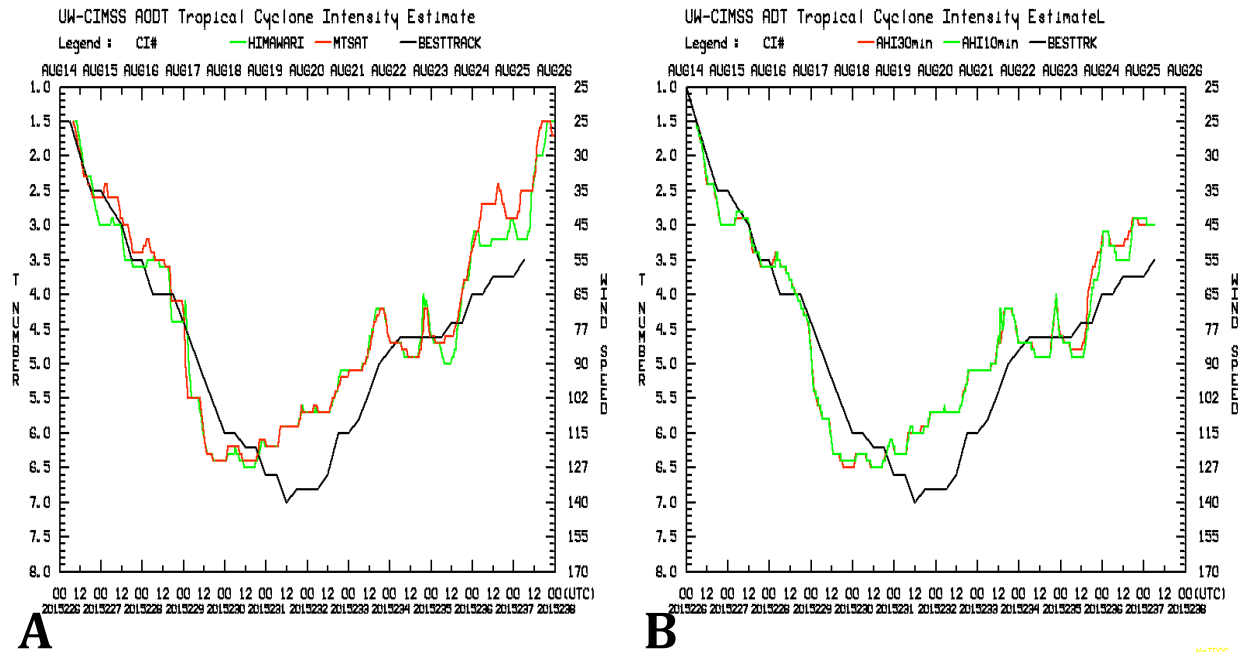

Figure 13. Comparisons between ADT intensity analyses using A) MTSAT (red line) and Himawari-8 (green line) imagery and B) Himawari-8 30-minute (red line) and 10-minute (green line) imagery for Tropical Cyclone 17W. The JTWC best track intensity is provided for comparison (black line).

### Publications and Conference Reports

Olander, T. and C. Velden, 2016: The current status of the Advanced Dvorak Technique (ADT). 32nd AMS Hurricanes and Tropical Meteorology Conference, San Juan, PR, April 17-22.

Velden, C. and T. Olander, 2016: Reprocessing the “Top Ten” most intense tropical cyclones in the satellite era using the Advanced Dvorak Technique. 32nd AMS Hurricanes and Tropical Meteorology Conference, San Juan, PR, April 17-22.



Olander, T. and C. Velden, 2016: The Advanced Dvorak Technique. 2nd International Workshop on Satellite Analysis of Tropical Cyclones (IWSAT-II), Honolulu, HI, February 17-19.

## References

Olander, T. and C. Velden, 2007: The Advanced Dvorak Technique: Continued Development of an Objective Scheme to Estimate Tropical Cyclone Intensity Using Geostationary Infrared Satellite Imagery. *Wea. & Forecasting*, 22, 287-298.

## 4.10 Volcanic Ash

**CIMSS Task Leader: Justin Sieglaff**

**CIMSS Support Scientist: John Cintineo**

**NOAA Collaborator: Mike Pavolonis**

**Budget: \$60K**

### NOAA Long Term Goals:

- Weather-Ready Nation

### NOAA Strategic Goals:

- Serve society's needs for weather and water
- Support the nation's commerce with information for safe, efficient and environmentally sound transportation
- Provide critical support for the NOAA mission

### CIMSS Research Themes:

- Satellite Meteorology Research and Applications
- Satellite Sensors and Techniques

## Objective

We will continue calibration and validation efforts to ensure Day 1 readiness for GOES-R volcanic ash products.

## Project Overview

We have adopted an infrared-based approach for detecting the presence of ash. This information is supplied to an ash cloud height and mass loading retrieval scheme. We propose to continue to conduct the cal/val and development work required to assure that we achieve the F&PS specifications for the volcanic ash products. We will perform extensive validation using spaceborne lidar (e.g., CALIPSO) observations of volcanic ash and dust clouds. Any problems discovered in the cal/val process will be addressed. Much of the work will also be aimed at providing GOES-R Ground System (GS) contract support. This work will insure the readiness of the volcanic ash algorithm for operational implementation upon the deployment of GOES-R.

## Milestones with Summary of Accomplishments and Findings

- *Complete development of V5 validation code for volcanic ash product*
- *Test algorithms on actual AHI data, if data are available*

An eruption of the Indonesian volcano, Rinjani on November 4, 2015 offered the opportunity to both test the volcanic algorithms using AHI data as well as the volcanic ash validation tools. Figure 14 shows a 4-panel image—the upper left is a false color image and the remaining panels are the GOES-R volcanic ash products. The black line indicates the overpass of the spaceborne lidar CALIOP, which serves as truth data for



cloud height. The bottom image is a cross-section along the CALIOP overpass with GOES-R ash heights overplotted as white dots. The figure demonstrates the Himawari-8 derived GOES-R ash heights agree well with space-borne lidar. The components of Figure 14 were all created with the GOES-R AWG volcanic ash validation tools.

Additionally, we developed a procedure to flag AHI pixels that are likely impacted by sub-pixel co-registration errors in the 10-12 um window region (AHI channels 13, 14, and 15). This procedure can be applied to the ABI should it experience the same co-registration issues. The volcanic ash products are greatly impacted by co-registration errors in the 10-12 um region.

### Publications and Conference Reports

Pavolonis, M. J., A. K. Heidinger, and J. Sieglaff (2013), Automated retrievals of volcanic ash and dust cloud properties from upwelling infrared measurements, *J. Geophys. Res. Atmos.*, 118, doi:[10.1002/jgrd.50173](https://doi.org/10.1002/jgrd.50173).

### References

Pavolonis, M. J., 2010: Advances in extracting cloud composition information from spaceborne infrared radiances: A robust alternative to brightness temperatures. Part I: Theory. *J. Applied Meteorology and Climatology*, 49, 1992-2012.

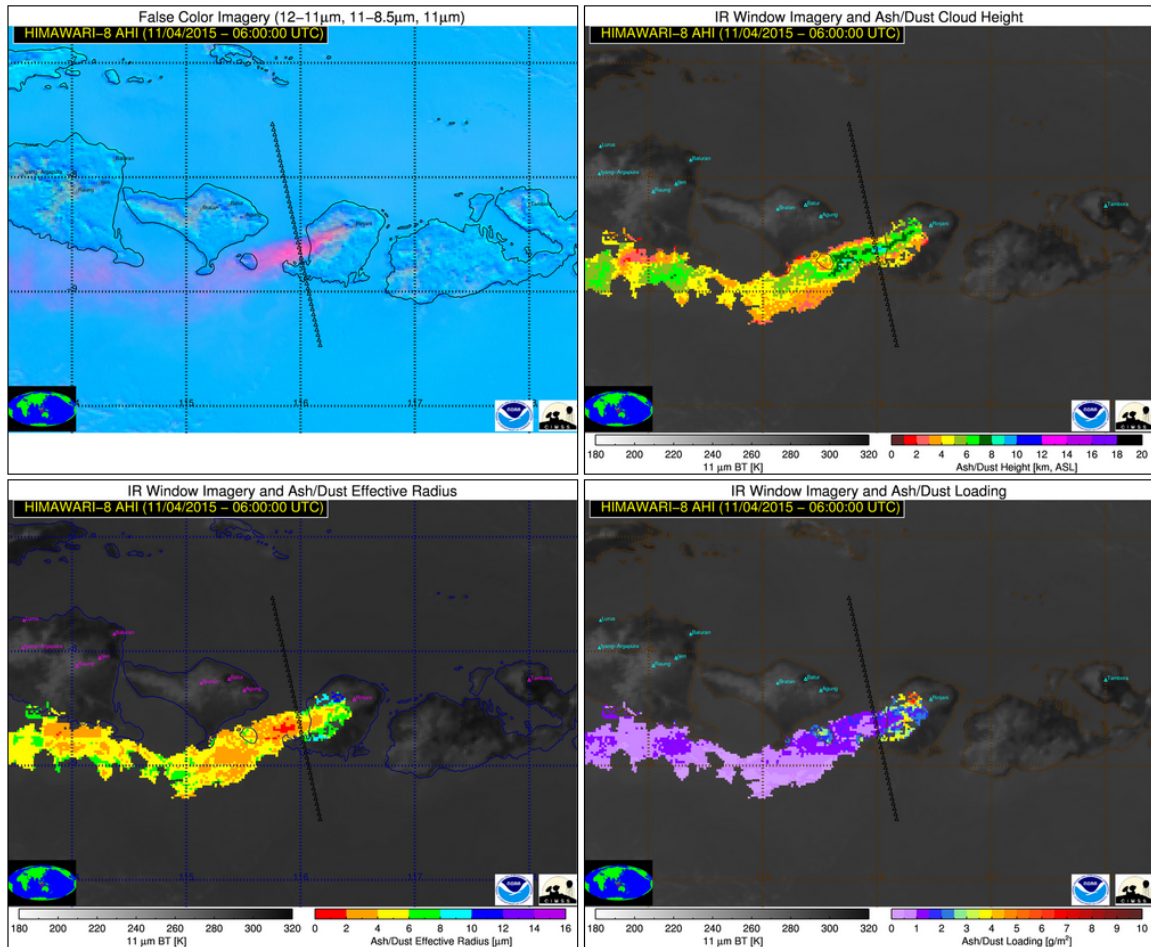

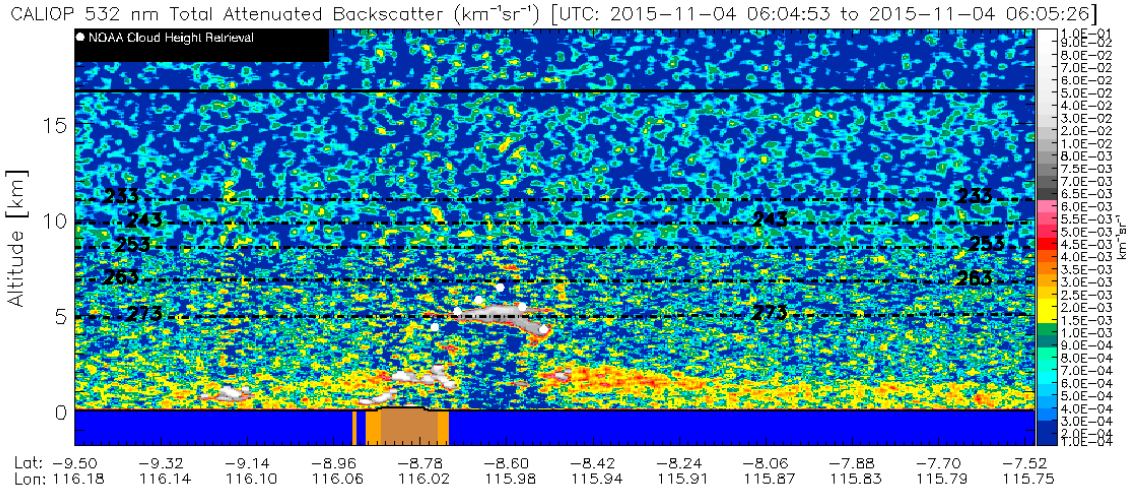

Figure 14. The Himawari-8 derived ash detection and ash cloud height products are validated using CALIOP measurements. The above figures show that the Himawari-8 products agree well with the space-based lidar measurements taken at 06:05 UTC on November 4, 2015. The GOES-R AWG validation tools were used to generate this analysis.

#### 4.11 Imagery and Visualization

**CIMSS Task Leader: Mathew Gunshor**

**CIMSS Support Scientists: Kaba Bah, Joleen Feltz, Jim Nelson, Hong Zhang**

**NOAA Collaborator: Tim Schmit**

**Budget: \$200,000**

#### NOAA Long Term Goals:

- Weather-Ready Nation

#### NOAA Strategic Goals:

- Serve society's needs for weather and water
- Provide critical support for the NOAA mission

#### CIMSS Research Themes:

- Satellite Meteorology Research and Applications
- Satellite Sensors and Techniques

#### Objective

The primary objective of the AWG Imagery Team is to ensure the quality of the ABI Cloud and Moisture Imagery Product (CMIP), which is the Key Product Parameter (KPP) on ABI.

#### Project Overview

The AWG Imagery Team has developed the format for ABI data which includes the fixed grid format and GRB-like data structure. Now in the validation phase, better methods by which ABI imagery will be quality controlled are being developed. Past efforts had primarily been theoretical approaches to data validation and now the project moves into practical applications of validation, including testing on current GOES.

For visualization, McIDAS-V is CF-netCDF ready, meaning it understands the structure and semantics of CF conventions so the official product files of the GOES-R ABI can be immediately



imported into the system without any additional programming. While an excellent interactive visualization tool, it remains relatively under-utilized as a scripting tool for more automated, or repeatable, validation applications. The Imagery Team is exploring McIDAS-V scripting capabilities and working with the McIDAS programming team to more fully develop them.

The Imagery Team proposed to: continue to support DOST/DOE visualizing and validating the L2b imagery outputs and GRB files; support Product Definition and Users' Guide (PUG) releases, validating PUG contents regarding imagery and comparing to file content; continue product validation activities and tool development, including testing on AHI data; support other GOES-R program efforts to develop ADDE servers for visualization and generation of McIDAS AREA files, both AHI and ABI; support study of alternative scan mode scenarios; and continue algorithm and ATBD maintenance as needed.

### **Milestones with Summary of Accomplishments and Findings**

The milestones proposed this year were as follows:

- Apr 2015: Test AHI McIDAS-X/V ADDE server; validation activity for ABI
- May 2015: Test ABI McIDAS-X/V ADDE server, serving DOE generated output.
- Jun 2015: Reports on PUG, DOE, and DOST validation activities.
  - Jun 2015: DOE-1
  - Jul 2015: DOE-2
  - Aug 2015: DOE-3
  - Nov 2015: DOE-4
- Dec 2015: McIDAS-V scripts to display Level 2B Imagery
- Jan 2016: McIDAS-V scripts to display difference images, with statistics.
- Feb 2016: GOES-R Imagery website prototype; imagery from scripts.
- March 2016: Validation plan documentation (updates as required).
- March 2016: Updated versions of McIDAS-V complete with documentation, if applicable.

All of these milestones have been addressed, though some were reported on in a previous report. The McIDAS-V scripts to display imagery and also difference images with statistics have been demonstrated but continue to be developed. Some tools the team considers not complete because while we have simulated data, we do not have access to simulated data that replicates near-real-time data flow.

The scripts to display Level 2b Imagery in McIDAS-V have been demonstrated using simulated ABI data. Full disk images of each band and a 16-panel CONUS display (Figure 15) were generated. These displays have been delivered to the "First Light Imagery" team which requested a mock up. Some work remains in tidying up these displays with better color enhancements and the logos that the First Light Imagery team requests. Work also continues to get this process working on more than computer so that we have a backup process if needed.

The McIDAS-V scripts that display difference images with statistics have been demonstrated using current GOES imagery. This is being done in conjunction with a project to automate stray light detection. The statistics can be saved to a separate text file and plotted directly on the image. This includes a histogram and various statistics that have been found to be pertinent to stray light detection. This functionality continues to be refined.



Validation plan documentation has become the process of working with the GOES-R Program on a Readiness, Implementation and Management Plan (RIMP). The Imagery team worked with the Imagery Team Chair and Aerospace representatives to develop this document.

McIDAS-X version 2016.1 was released and supports ABI data and there is an ABI ADDE data server now that can be used for testing as well. There has not been an official release of McIDAS-V during this reporting period. This is outside of the Imagery Team's control, but the team does continue to work with McIDAS-V developers to refine the software for use with ABI data and to improve the scripting process. Team members are active posters to the McIDAS-V forums, work closely with McIDAS developers, and are members of the McIDAS Advisory Committee (MAC), including chairing the committee. Most team members also use the "nightly build" version of McIDAS-V which is pre-release software, considered not stable for public release, but which has all of the latest updates for GOES-R. One example is making netCDF attributes in ABI CMIP files available to users when loading data. Also adjusting the software to using the image start time available in the netCDF files instead of the time variable "t" since that is really the mean time between image start and end times (GOES users have traditionally used the nominal start time to describe image times).

As part of the effort to develop a website prototype for imagery, the team continues to develop Unix scripts that will generate images, manipulate them (such as creating 16 panel displays, putting on logos, or overlaying text) and even generate animations from sequences of images. While most imagery will appear in SSEC's RealEarth application, these animations will be used in presentations and on the CIMSS Satellite Blog for public outreach. This capability was demonstrated once again using GOES-14 Super Rapid Scan Operations for GOES-R (SRSOR) data. SRSOR in February 2016 imagery was placed on the CIMSS web site. Animations were generated for nearly every day of the SRSOR test and covered many phenomena including convective snow, severe thunderstorms, wildfires, blowing dust, and lake effect snow. Several of these cases were read about on the CIMSS Satellite Blog.

SRSOR website: [http://cimss.ssec.wisc.edu/goes/srsor2016/GOES-14\\_SRSOR.html](http://cimss.ssec.wisc.edu/goes/srsor2016/GOES-14_SRSOR.html)

SRSOR blog entries: <http://cimss.ssec.wisc.edu/goes/blog/archives/category/goes-14>

In continued development of deep-dive tools a program for McIDAS-X called ID is in its early stages. This program will allow an analyst to display data and then get radiances with subsequent reflectance factors and brightness temperatures for all bands at any location. Locations can be chosen manually, such as a latitude/longitude pair, or by pointing the cursor at a location in a displayed image. A similar program to this has existed for many years that works on current GOES imager and sounder data and has been utilized frequently in the analysis of problems with imagery and calibration.

While McIDAS-X and McIDAS-V continue to be utilized the team also has access to AWIPS-II and data broadcast over NOAAPORT. The NWS is turning AAWDS proxy data generated by the proxy team into the format necessary to transmit over NOAAPORT, at ABI-like cadences. The team has verified the NOAAPORT feed and has been working on color enhancements that are similar to those used by CIMSS and CIRA traditionally on current GOES. There may be issues presented in Mode 3 for AWIPS-II CONUS because the NWS has customized CONUS views that do not coincide with the actual CONUS scans of the ABI instrument. Their custom CONUS views are seemingly meant to be cut out of the full disk. There may also be issues in AWIPS II with the NWS being able to get meso-scale images at 30 second time resolution because their system seemingly only takes into account minutes, not seconds. This was a problem for McIDAS





users prior to the latest version because the software was written to the nearest minute, not seconds, as well; McIDAS servers can now handle data to the second.

The primary responsibility for generating true color images from ABI falls to CIRA, but the Imagery Team at CIMSS has been collaborating with CIRA scientists to generate different types of true color imagery. The teams have been using AHI data from Himawari-8 and CIMSS was host to a Japanese Meteorological Association (JMA) scientist for a year who assisted as well. The work resulted in a manuscript being accepted by the Bulletin of the American Meteorological Society (BAMS), "A Sight for Sore Eyes—The Return of True Color to Geostationary Satellites." The authors are mix of CIRA, CIMSS, NOAA, and JMA: Steven Miller, T. Schmit, C. Seaman, D. Lindsey, M. Gunshor, R. Kohrs, Y. Sumida, and D. Hillger.

In addition to these activities, the Imagery Team continues to contribute to the ABI Band Fact Sheets that are published on the GOES-R website. The team provides multiple types of images and figures for these types of education and outreach activities, including images that show approximate pixel area maps, the size of CONUS scans for GOES-East and GOES-West locations, and the size/shape of mesoscale scans which can vary greatly depending on location. Additionally weighting function plots from forward model calculations and spectral response functions figures have been provided. This material is also being used to train NWS employees and is used in short courses at the AMS annual meeting and broadcaster conferences.

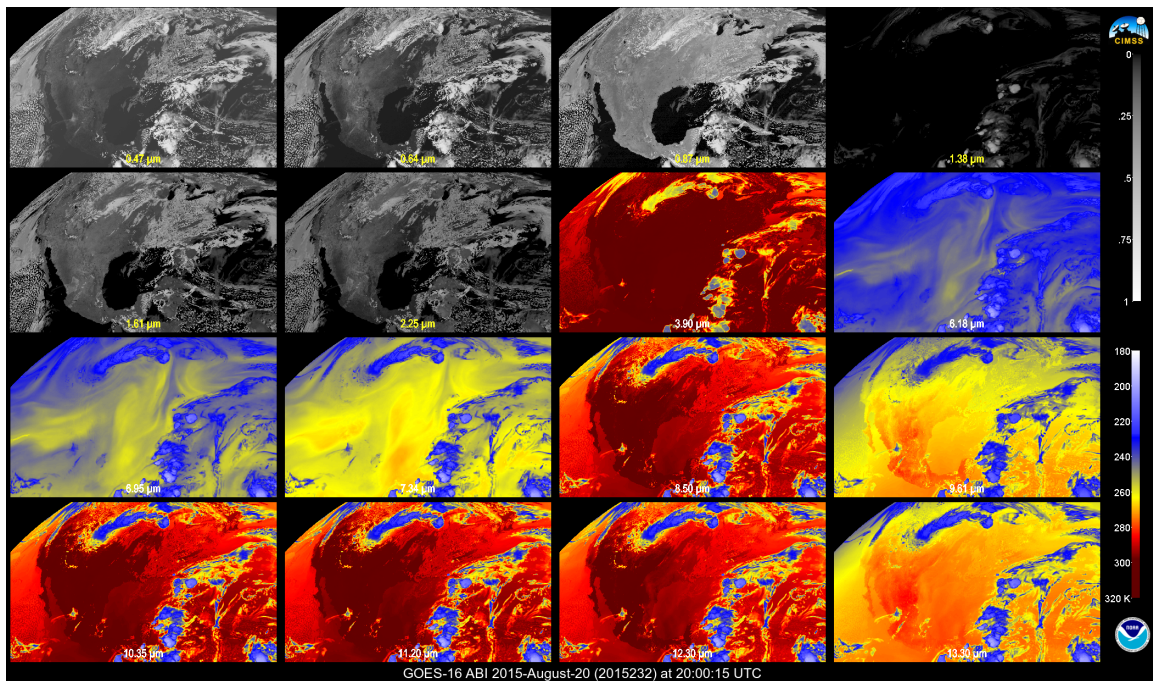

Figure 15. A 16 panel CONUS "First Light Imagery" mock up generated using a combination of McIDAS-V scripting and ImageMagick. Data are proxy ABI simulated for August 20, 2015 at 20:00 UTC.

### Publications and Conference Reports

"The Pre-launch History of the Advanced Baseline Imager (ABI) on GOES-R" an invited presentation at the American Meteorological Society annual meeting, 13 January 2016, New Orleans, LA. By Timothy J. Schmit (NOAA/NESDIS/STAR), M. M. Gunshor (CIMSS), J. J. Gurka (NOAA, retired), and W. P. Menzel (CIMSS).



“Using McIDAS-V with the next Generation of Satellite Sensors” a presentation at the American Meteorological Society annual meeting, 13 January 2016, New Orleans, LA. By Joleen M. Feltz, (CIMSS), M. M. Gunshor (CIMSS), R. M. Rabin (NOAA/NSSL), and T. J. Schmit (NOAA/NESDIS).

“The Return of True Color to Geostationary Satellites: Transitioning from Polar, to Himawari, to GOES-R” a presentation at the American Meteorological Society annual meeting, 13 January 2016, New Orleans, LA. By Steven D. Miller (CIRA), T. J. Schmit (NOAA/NESDIS), C. J. Seaman (CIRA), M. Gunshor (CIMSS), D. T. Lindsey (NOAA/NESDIS), D. W. Hillger (NOAA/NESDIS), and Y. Sumida (JMA).

**4.12 Estimate of Fractional Snow Cover with ABI**  
**CIMSS Task Leaders: Yinghui Liu, Xuanji Wang**  
**NOAA Collaborator: Jeffrey Key**  
**Budget: \$65,000**

**NOAA Long Term Goals**

- Climate Adaptation and Mitigation
- Weather-Ready Nation

**NOAA Strategic Goals:**

- Serve society’s needs for weather and water
- Understand climate variability and change to enhance society’s ability to plan and respond
- Provide critical support for the NOAA mission

**CIMSS Research Themes:**

- Satellite Meteorology Research and Applications

**Objective**

Test, implement, and document the fractional snow cover algorithm for the ABI.

**Project Overview**

The goal of this project is to continue to test, implement, and document the fractional snow cover algorithm for the GOES-R Advanced Baseline Imager (ABI). The product will provide the sub-pixel area covered by snow. The primary users of the snow cover product are the National Ice Center (NIC), NCEP, and NWS forecasters.

We will continue with algorithm validation, which is largely an effort to expand the scope of validation to a broader range of geographic areas and conditions. AVHRR, MODIS, and SEVIRI data are being used as proxy data for the purpose of testing and validating the algorithm. In situ and other satellite data, e.g., JMA’s AHI and passive microwave-derived snow cover, as available, and independent estimates of fractional snow cover retrieved from higher resolution imaging systems (e.g., LANDSAT) under a variety of conditions will also be used to evaluate the accuracy of the product.

**Milestones with Summary of Accomplishments and Findings**

Starting in FY12, the Option 2 (“future capabilities”) cryosphere products are not being funded. The Option 2 products are Ice Cover, Ice Concentration, Ice Age/Thickness, Ice Motion, and



Snow Depth (tall grass prairies). CIMSS has played the leading role in developing ice products for ABI. The snow cover algorithm was developed by members of the AWG Cryosphere Team at the NWS National Operational Hydrologic Remote Sensing Center (NOHRSC) and the University of Utah (Tom Painter, now UCLA/JPL) (Dozier et al. 2009, Painter et al. 2009). For long-term maintenance of the algorithm it is decided that CIMSS and the NOAA Advanced Satellite Products Branch (ASPB) will take ownership of the software and documentation to ensure long-term viability as a NESDIS operational product. This proposal is for the early steps of the process: obtaining, evaluating, and implementing the fractional snow cover software, and expanding the validation activities.

Previous work has been focused on becoming familiar with the Fractional Snow Cover software package, documentation, and its test data. The software was compiled, tested, and implemented at CIMSS. Running the software on the test data showed and gave the same results as provided by GOES-R AWG AIT. Case studies of GOES-R ABI fractional snow product have been carried out to evaluate and improve the current level 2 products. Figure 16 shows a comparison of GOES-R ABI Level 2 snow cover on June 19, 2015 using proxy data during the data operations exercise 1 and 2, and snow cover from the National Ice Center's Interactive Multisensor Snow and Ice Mapping System on June 19, 2015. Near real time product is being developed using MODIS data as proxy here in CIMSS. A website will be created to present the results. Future work includes routine runs on more test data on MODIS, SEVERI, and possibly AVHRR and JMA's H-8/AHI data when available. New validation studies that extend previous activities, both spatially and with other comparison datasets (e.g., IMS, passive microwave products, and Landsat) will be carried out.

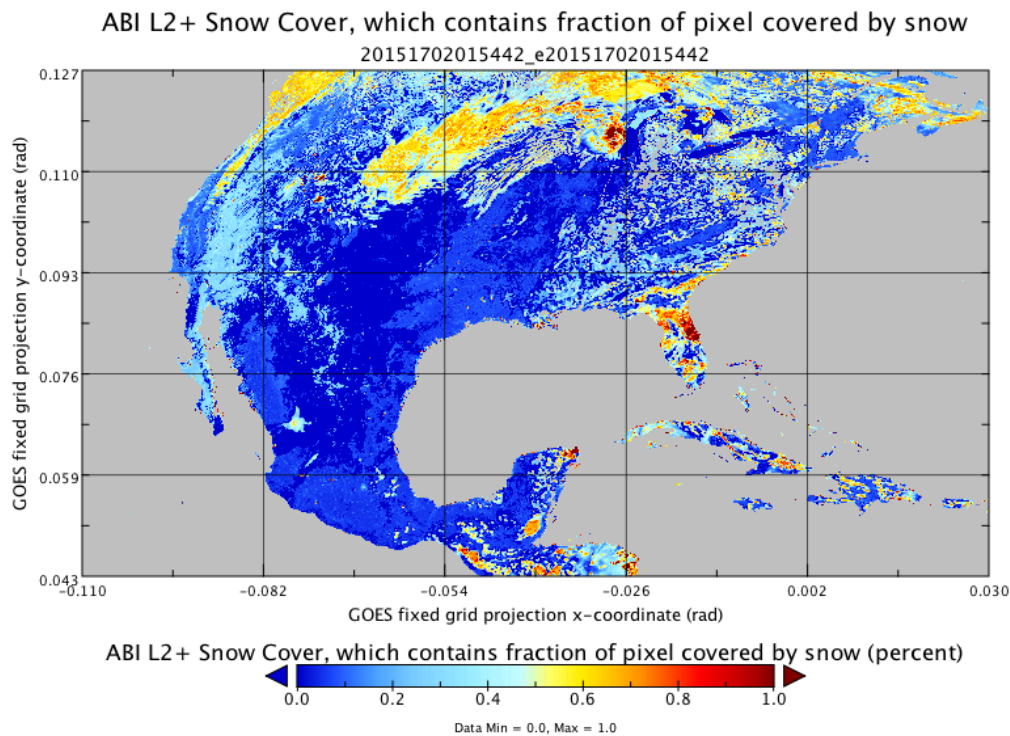

Figure 16. GOES -R ABI Level 2 snow cover on June 19, 2015 using proxy data during the data operations exercise 1 and 2 .



## References

Dozier, J., R. O. Green, A. W. Nolin, and T. H. Painter (2009), Interpretation of snow properties from imaging spectrometry, *Remote Sensing of Environment*, doi: 10.1016/j.rse.2007.07.029.

Thomas H. Painter, Karl Rittger, Ceretha McKenzie, Peter Slaughter, Robert E. Davis, Jeff Dozier, 2009, Retrieval of subpixel snow covered area, grain size, and albedo from MODIS, *Remote Sensing of Environment*, 113, 868-879, 2009.

## 5. CIMSS Participation in the GOES-R Future Capabilities for 2015-2016

### 5.1 GOES-R Future Capability: Development of the GOES-R Tropical Overshooting Top (TOT) Product

**CIMSS Task Leaders: Chris Velden and Sarah Griffin**

**NOAA Collaborator: Mark DeMaria (NHC)**

**Budget: \$75,000**

#### NOAA Long Term Goals:

- Weather-Ready Nation

#### NOAA Strategic Goals:

- Serve society's needs for weather and water
- Support the nation's commerce with information for safe, efficient and environmentally sound transportation
- Provide critical support for the NOAA mission

#### CIMSS Research Themes:

- Satellite Meteorology Research and Applications
- Satellite Sensors and Techniques

#### Objective

Develop a tool to identify vigorous convection in tropical regions, and determine if it can be used as a predictor of tropical cyclone genesis or rapid intensification.

#### Project Overview

The GOES-R Tropical Overshooting Top (TOT, Monette et al. 2012) product is an algorithm designed to identify convective updrafts and overshooting tops in tropical environments, specifically tropical cyclones (TCs). The TOT algorithm is a derivative of the GOES-R Overshooting Top (OT) product, and utilizes the 10.9- $\mu\text{m}$  infrared window to identify isolated pixels that are significantly colder than their surroundings (convective overshoots). Trends in TOTs have some correlation with TC genesis and rapid intensification, and have been a part of the National Hurricane Center (NHC) Proving Ground product list since 2011. Feedback from the Proving Ground has facilitated multiple updates to the TOT product.

The TOT product has also been used as a real-time hazard avoidance tool for the Global Hawk pilotless aircraft flown during NASA's Hurricane and Severe Storm Sentinel (HS3) and NOAA's SHOUT field experiments for the past 3 Atlantic hurricane seasons. Feedback from these field programs was positive, with a request that the TOT heights (rather than temperatures) be estimated for better use with aircraft altitude data.



### Milestones with Summary of Accomplishments and Findings

**Milestone 1.** The Topical Overshooting Top (TOT) algorithm was updated in 2015 to increase detection in the inner core of tropical cyclones (TC) and reduce false alarms. After the update, TOTs were again tested for skill at predicting tropical cyclone (TC) rapid intensification (RI). TOTs are found to be skillful at predicting RI, as indicated by the positive Peirce Skill Score (PSS) in Figure 17. The PSS is defined as the probability of detection (POD) minus the probability of false detection (POFD). However, the TOT RI Index is less skillful at predicting RI compared to the multi-predictor Rapid Intensification Index (RII). The RII (red bars) has a greater POD and lower false alarm rate (FAR) than the TOT RI Index (blue bars). Adding TOTs to the RII (black bars) increases the skill of yes-no RI forecast, based on the PSS, by increasing the POD while only slightly increasing the FAR compared to the RII. Given the positive results for TOTs predicting TC RI as a single predictor, TOTs were added to an experimental operational probabilistic RI forecast scheme with multiple predictors. Overall, the TOTs had negligible impact on the Brier Skill Score, therefore TOTs are currently not considered for inclusion in a multi-predictor RI scheme which already has other satellite-derived and lightning predictors.

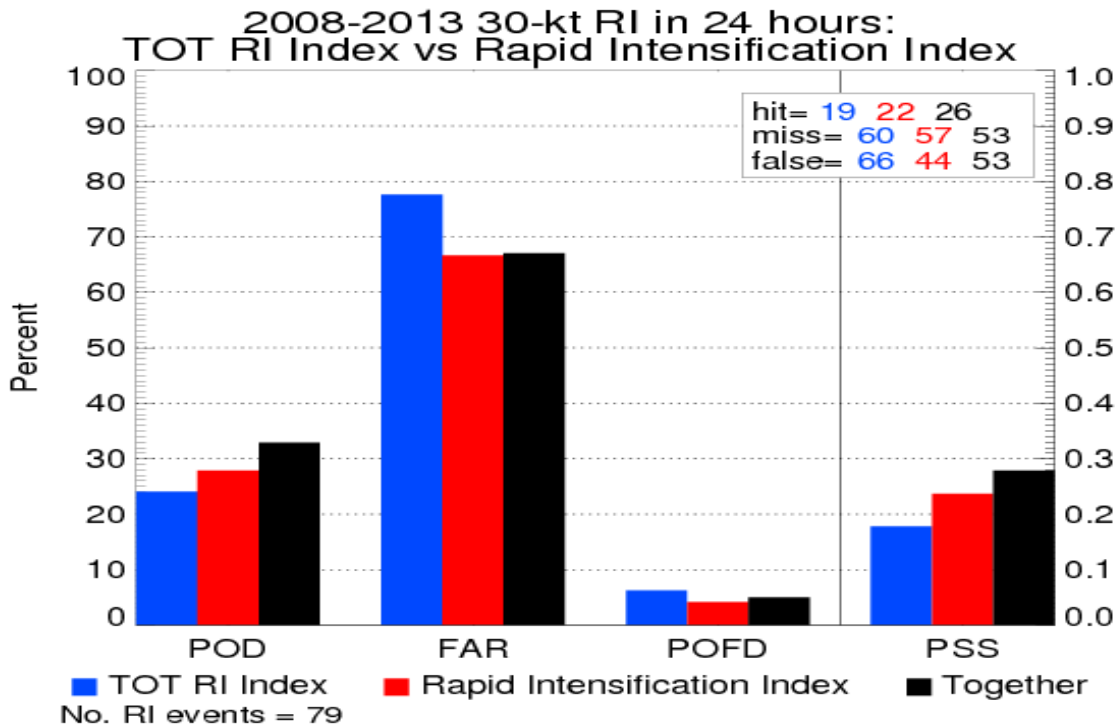

Figure 17. Results of a yes-no forecast for tropical cyclone (TC) rapid intensification (RI) for the single-predictor TOT RI Index (blue), multi-predictor Rapid Intensification Index (RII; red) and combined (black). Overall, all methods are skillful at predicting TC RI, as indicated by the positive Peirce Skill Score (PSS). The multi-predictor RII is more skillful than the TOT RI Index, but adding the TOTs to the RII increases the RII skill.

**Milestone 2.** TOTs can also serve as a proxy for measuring the amount of active convection associated with a potential developing TC. As increased convection is associated with TC genesis, TOTs could potentially predict if TC genesis will occur or not. TOTs are tested as a stand-alone predictor of TC genesis using tracks of 324 National Hurricane Center (NHC) “Invests” from 2005-2013. TOTs are averaged within selected radii/annuli and over different time frames to find the optimal combination for predicting genesis. To simulate the skill at forecasting TC genesis, a leave-one-year-out cross validation approach is utilized: An optimal combination of



radius/annulus and time frame for TOT averages is found using all but one year of Invests. Then, this combination is used to predict genesis for the one year of Invests left out. This process is repeated 9 times, until each year is left out. The results are shown in Figure 18. Overall, the TOTs are skillful at predicting if an Invest will develop in the next 12, 24, 48, and 120 hours based the positive Heidke Skill Score (HSS).

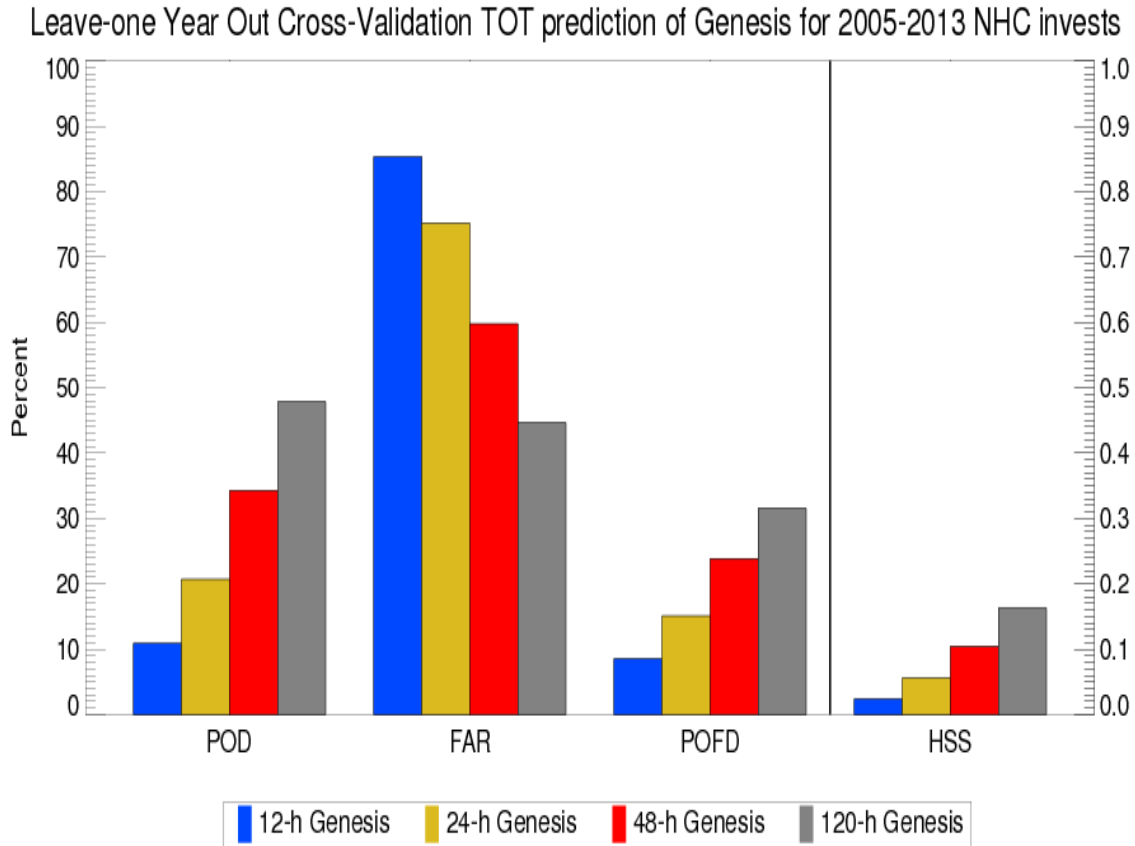

Figure 18. Probability of detection (POD), false alarm ratio (FAR), probability of false detection (POFD), and Heidke Skill Score (HSS) for TOT prediction of TC genesis. Positive HSS indicates the forecast for each timeframe is skillful.

### Publications and Conference Reports

Griffin, S. M., K. M. Bedka, and C. S. Velden, 2016: A Method for Calculating the Height of Overshooting Convective Cloud Tops Using Satellite-Based IR Imager and CloudSat Cloud Profiling Radar Observations. *J. Appl. Meteor. and Climatol.*, 55, 479-491.

### 5.2 GOES-R Future Capability: Continued Development of the GOES-R AWG Fog/Low Cloud Products

**CIMSS Task Leaders: Corey Calvert and Shane Hubbard**

**CIMSS Support Scientists: Chad Gravelle and Scott Lindstrom**

**NOAA Collaborator: Michael Pavolonis**

**Budget: \$54,100**



### **NOAA Long Term Goals:**

- Weather-Ready Nation

### **NOAA Strategic Goals:**

- Serve society's needs for weather and water
- Support the nation's commerce with information for safe, efficient and environmentally sound transportation
- Provide critical support for the NOAA mission

### **CIMSS Research Themes:**

- Satellite Meteorology Research and Applications
- Satellite Sensors and Techniques

### **Objective**

We are developing the next generation fog/low cloud detection algorithm that improves upon heritage methods by fusing satellite, numerical weather prediction model and other ancillary data sets to produce a probability that various hazardous low cloud conditions are present.

### **Project Overview**

Low ceiling and visibility is a weather hazard that nearly every forecaster, in nearly every National Weather Service (NWS) Weather Forecast Office (WFO), must regularly address. As such, reliable methods for detecting and characterizing hazardous low clouds are needed. Traditionally, hazardous areas of Fog/Low Stratus (FLS) are identified using a simple stand-alone satellite product that is constructed by subtracting the 3.9 and 11  $\mu\text{m}$  brightness temperatures. However, the 3.9-11  $\mu\text{m}$  brightness temperature difference (BTD) has several major limitations. In an effort to address the limitations of the 3.9-11  $\mu\text{m}$  BTD, the GOES-R Algorithm Working Group (AWG) developed an approach that fuses satellite, Numerical Weather Prediction (NWP) model, Sea Surface Temperature (SST) analyses, and other data sets (e.g. digital surface elevation maps, surface emissivity maps, and surface type maps) using a naïve Bayes classifier to determine the probability that Marginal Visual Flight Rules (MVFR), Instrument Flight Rules (IFR), and Low Instrument Flight Rules (LIFR) conditions are present at the resolution of the satellite data. MVFR/IFR/LIFR conditions are characterized by a cloud ceiling below 3000/1000/500 ft and/or a surface visibility less than 5/3/1 mile(s) respectively. The GOES-R fog/low cloud algorithm is an enterprise system in that it can use satellite data from a variety of current data sensors (GOES, MTSAT, MODIS, AVHRR and SEVIRI) and future operational sensors (ABI, AHI and VIIRS) and NWP data from a variety of models (GFS, RUC and RAP). Validation efforts, using surface observations over CONUS from each month of the year, indicate that the GOES-R IFR probability product is nearly twice as skillful as the traditional 3.9-11  $\mu\text{m}$  BTD product at identifying IFR conditions, while also providing additional probabilities about whether the cloud meets MVFR or LIFR criteria. The GOES-R approach incorporates the information given by the 3.9-11  $\mu\text{m}$  BTD, so the traditional BTD product never significantly outperforms it. Further, unlike the traditional product, the GOES-R probabilities have the same interpretation day and night. Thus, the GOES-R probability products should be thought of as an upgrade to the traditional product, not a complement or supplement. Finally, in addition to the probability products, the GOES-R FLS algorithm also produces an estimation of the fog/low stratus thickness (cloud top height minus cloud base height). The GOES-R FLS thickness product can be used to infer dissipation time for single cloud layer radiation fog events.

For the most part, the main products mentioned above have already been developed. However, only a few people outside of the algorithm developers have been trained to properly use and



understand the products. For this reason, along with further algorithm development, we proposed to create and maintain a comprehensive training module that can be used to remotely train forecasters and other users on how to correctly interpret the GOES-R FLS products. Using this training module we want to continue introducing the GOES-R FLS products to more NWS WFO's and other potential users so they can start working with them, evaluate them, provide feedback and eventually replace the traditionally-used 3.9-11  $\mu\text{m}$  BTD as they become more comfortable using them. This project will ensure the readiness of the fog/low cloud algorithm for operational implementation upon the deployment of GOES-R.

### **Milestones with Summary of Accomplishments and Findings**

- *Continue to validate GOES-R fog/low cloud products using standard surface observations as well as detailed cloud property measurements from field campaigns conducted by Environment Canada*  
Validation was performed using standard surface observations of surface visibility and cloud ceiling. These results will be presented in a publication to be submitted soon. Validation analyses were also conducted using high latitude (cold climate) field campaign measurements provided by Environment Canada. Additional validation analyses were also conducted using field experiment data and offshore oilrig measurements provided by Environment Canada.
- *Continue to refine approach used to blend morphometric landform information and LEO data into GOES-R FLS algorithm*  
The incorporation of morphometric landform classifiers and the merging of GEO and LEO data have been even more fruitful than originally thought. By combining GOES-R IFR probabilities with high-resolution topographic information, the low-resolution GOES-R FLS product can be downscaled to the spatial resolution of the digital elevation model thereby greatly improving the spatial detail provided depicted the FLS products. In addition, data from LEO satellites are being used in concert with the morphometric landform metrics to further improve the Bayesian classifier via the *a priori* (see Figure 19 and [http://www.jpss.noaa.gov/science\\_seminars/Presentations/SSP24\\_JPSS\\_GOESR\\_FLS\\_Pavolonis\\_Dec12014\\_v2.pdf](http://www.jpss.noaa.gov/science_seminars/Presentations/SSP24_JPSS_GOESR_FLS_Pavolonis_Dec12014_v2.pdf)). The downscaling procedure is still being developed, but shows great promise.
- *Continue development of fog formation alerting capability*  
The downscaled FLS probabilities are still being developed. Once at a mature level they will be used to develop a valley fog formation alerting capability.
- *Continue to develop procedure to convert fog thickness product into a map of estimated fog dissipation times*  
A relationship between the GOES-R cloud thickness product and the dissipation time of single cloud layer radiation fog events has been calculated. We are developing methods to best incorporate this information into a product that can be adequately displayed on a map or in AWIPS/NAWIPS/AWIPS-II.
- *Continue Satellite PG demonstration at Alaska Aviation Weather Unit (AAWU) and the Aviation Weather Center (AWC)*  
The AAWU AWC has access to the GOES-R FLS products and are using them in operations and providing feedback.
- *Conduct Satellite PG demonstrations at Alaska, East, Central, and Western Region WFO's*  
The GOES-R FLS probability and thickness products are available in AWIPS/AWIPS-II and are currently being evaluated by several National Weather Service (NWS) Weather Forecast Offices (WFO's) as part of the Satellite Proving Ground. Forecaster feedback





collected so far has been predominantly positive and product improvements have been made as a result of the feedback. More than 30 NWS WFO's are also utilizing the GOES-R FLS products in operations and the products appear to be making positive contributions as noted by numerous product mentions in local Area Forecast Discussions (AFDs).

- *Add OPC relevant examples to training module*  
Additional training material was added to the GOES-R FLS training module specifically highlighting new and relevant examples of the products over their area of interest and how to interpret the results.

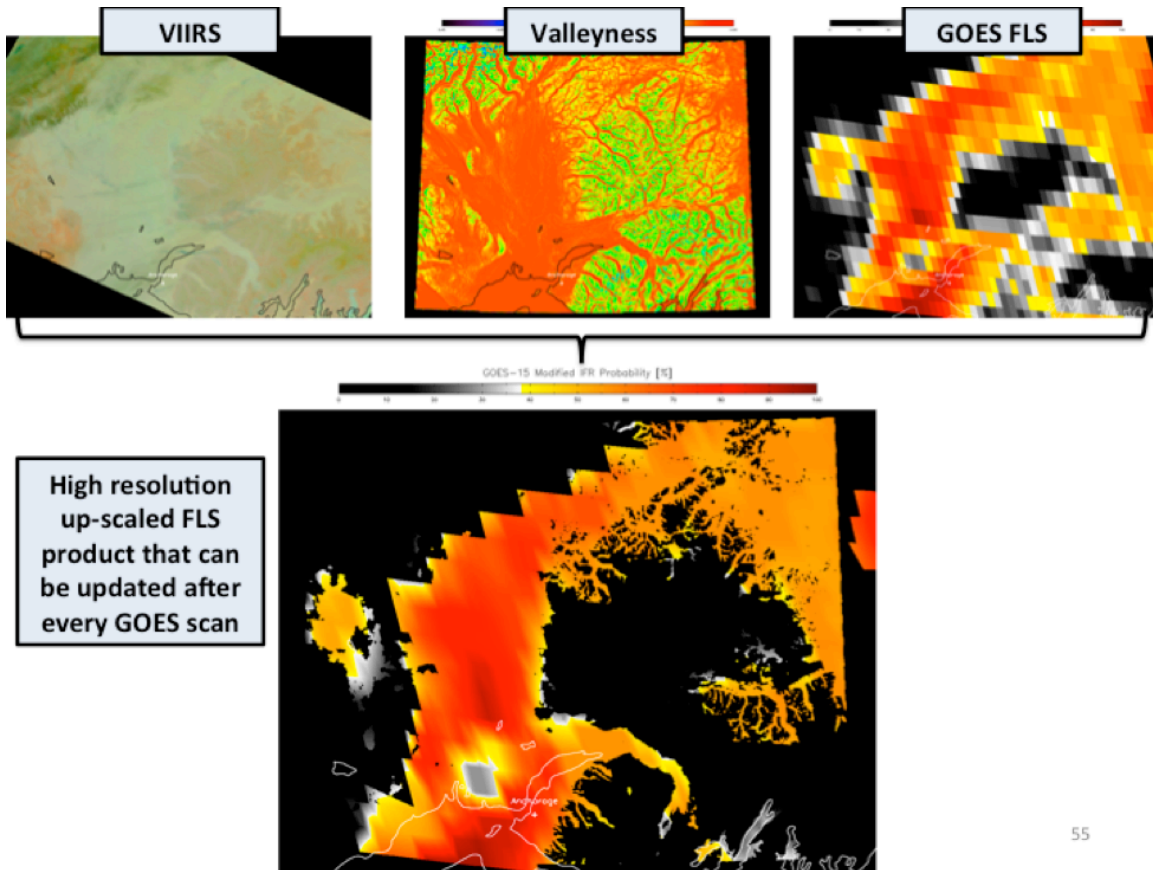

Figure 19. The end result of blending the GOES-West IFR probability product with VIIRS and the "valleyiness" metric, which is derived from digital elevation model, is shown in the bottom figure for a scene near Anchorage, AK. The course resolution GOES-West IFR probability product is effectively down-scaled to the resolution of the VIIRS product. The information content of the VIIRS image is maintained for many GOES images through use of the digital elevation model and temporal consistency.

### Publications and Conference Reports

Gultepe, I., B. Zhou, J. Millbrandt, A. Bott, Y. Li, A.J. Heymsfield, B. Ferrier, R. Ware, M. Pavolonis, T. Kuhn, J. Gurka, P. Liu, and J. Cermak, 2015: A review on ice fog: Measurements and modeling, *Atmospheric Research*, 151 (1), 2-19.

Gultepe, I., T. Kuhn, M.J. Pavolonis, C. Calvert, J. Gurka, A.J. Heymsfield, P.S.K Liu, B. Zhou, R. Ware, B. Ferrier, J. Milbrandt, B. Hansen, and B. Bernstein, 2014: Ice fog in the Arctic during the FRAM-IF project: Aviation and nowcasting applications., *Bull. Amer. Meteor. Soc.*, doi: 10.1175/BAMS-D-11-00071.1



Gultepe, I., R. Rabin, R. Ware, and M.J. Pavolonis, 2015: Arctic light snow observations: Emphasis on “missing” precipitation, Submitted to J. Hydrometeorology.

Calvert, C.G. and M. Pavolonis, 2016: A fused probabilistic approach for detecting fog and low stratus clouds. To be submitted to Weather and Forecasting.

### **5.3 Infrastructure – RGB Products in AWIPS II**

**CIMSS Task Leader: Mathew Gunshor**

**CIMSS Support Scientist: Kaba Bah**

**NOAA Collaborator: Tim Schmit**

**Budget: \$58,800**

#### **NOAA Long Term Goals:**

- Weather-Ready Nation

#### **NOAA Strategic Goals:**

- Serve society’s needs for weather and water
- Provide critical support for the NOAA mission

#### **CIMSS Research Themes:**

- Satellite Meteorology Research and Applications
- Satellite Sensors and Techniques

#### **Objective**

Work with the National Centers for Environmental Prediction (NCEP) and satellite liaisons at NOAA/NWS WPC/OPC/TAFB in conjunction with CIRA and SPoRT to test and display GRIB2 simulated ABI airmass RGB and reflected brightness temperatures in the NCP perspective.

#### **Project Overview**

This project builds on previous work done at CIMSS, CIRA, and SPoRT. Feedback from operational forecasters highlights the usefulness of RGB satellite imagery which helps to discriminate specific features of interest that are present in a complex scene. The three institutes in the past have developed and focused on their own RGB products and this year were coordinating more to better serve National Weather Service (NWS) forecast office eventual needs in the GOES-R era in terms of how products are delivered to the operational environment. The CIMSS team was focusing on the CIMSS RGB Air Mass product. The real-time ABI forecast imagery generated using WRF-CHEM and the CRTM (funded by GOES-R AWG) were used to generate the RGB imagery.

RGB imagery, along with more quantitative products, may provide the most information by exploiting the best of both attributes. The RGB allows a quick look, while the derived product, such as ozone, total precipitable water, etc. can provide for a better understanding of the current state. Simulated forecast imagery of the ABI spectral bands allow for preparation for the RGB combinations possible with the GOES-R ABI and provide a means of forecasting RGB imagery.

Results from this Infrastructure RGB Project will eventually be integrated into operations at WFOs and National Centers. The volume of data coming down from GOES-R is substantial and finding innovative ways to visualize the data to aid forecasters and others in operational arenas will help ensure the future success of GOES-R.



## **Milestones with Summary of Accomplishments and Findings**

The proposed milestones were as follows.

- Utilize the GRIB2 output from the NCEP Unified Post Processor (UPP) as a template to generate simulated ABI GRIB2 files.
- Use the newly defined synthetic GOES-R ABI bands in the NCEP GRIB2 tables to output CIMSS simulated ABI reflectance and brightness temperatures into GRIB2 files for visualization of air mass RGB images within the D2D and the National Centers Perspective (NCP).
- Work with NCEP to test and properly display these newly developed GRIB2 files from our simulated ABI reflectance and brightness temperatures in the NCP.

### **Needed Software Development within the NCP for Derived Product Capabilities**

On December 01<sup>st</sup> 2015, the joint airmass RGB team had a group meeting that was attended by all three cooperative institutes (CIMSS, CIRA, SPoRT) and the NCEP Satellite Liaison, at NASA SPoRT in Huntsville, AL during the AWIPSII EPDT training. The goal of the meeting was to investigate and discuss what is required to extend the derived parameters product capabilities within the NCP perspective similar to the current AWIPSII D2D RGB capabilities. The attendees were Michael J. Folmer (NCEP liaison), Scott Longmore (CIRA), Kevin Mcgrath (SPoRT) and Kaba Bah (CIMSS).

The team investigated and compared the RGB related java libraries within AWIPSII-D2D and NCP perspectives such as the Raytheon viz truecolor and abstract resources Java plugins and concluded that a significant amount of java code development would need to be done within the NCEP NCP architecture by adopting and customizing some of the java classes in the AWIPSII D2D into the NCP framework. These findings were then reported to the national centers AWIPS teams but they responded and said they currently do not have the resources to perform such development activities due to focus on current migration activities.

On March 17<sup>th</sup>, 2016 the joint airmass RGB team had a teleconference to figure a path forward and the consensus was to put together a joint proposal that includes funding to support a java developer to help us accomplish this goal. If successful, this will make it possible for all other offices that utilize the NCP perspective to locally generate RGB airmass by simply using already available data such as GOES-R ABI channels instead of regularly downloading relatively large derived product files from multiple institutes via the LDM.

### **Publications and Conference Reports**

Greenwald, Thomas J., R. B. Pierce, T. Schaack, J. Otkin, M. Rogal, K. Bah, A. Lenzen, J. Nelson, J. Li, and H.L. Huang, 2016. Real-time simulation of the GOES-R ABI for user readiness and product evaluation. *Bulletin of the American Meteorological Society*, Volume: 97:2, pp245-261.

## **5.4 Convective Initiation and 0-6 Hour Storm Nowcasting for GOES-R**

**CIMSS Task Leader: William Straka III**

**CIMSS Support Scientist: Steve Wanzong**

**NOAA Collaborator: Andrew Heidinger**

**Budget: \$6,000**



### **NOAA Long Term Goals:**

- Weather-Ready Nation

### **NOAA Strategic Goals:**

- Serve society's needs for weather and water
- Support the nation's commerce with information for safe, efficient and environmentally sound transportation
- Provide critical support for the NOAA mission

### **CIMSS Research Themes:**

- Satellite Meteorology Research and Applications
- Satellite Sensors and Techniques

### **Objective**

Process cloud algorithms from the current GOES and provide optical properties for the University of Alabama at Huntsville.

### **Project Overview**

The University of Alabama at Huntsville (UAH) is transitioning their current proxy Convective Initiation (CI) algorithm towards the GOES-R data stream. This transition involves incorporating the Cloud Type and Cloud Optical properties from the GOES-R Cloud Team algorithms into their processing system. Cloud properties such as visible optical depth, emittance, liquid water path, and effective particle radius can be used to quantify cumulus cloud growth in advance of CI. CIMSS continues to be tasked to process the cloud algorithms from the current GOES (East and West) and provide the optical properties in a timely manner.

### **Milestones with Summary of Accomplishments and Findings**

CIMSS continues to produce near real-time cloud products from GOES East and West for UAH. The cloud product software can also operate on archived data. To date, we have processed several hours of GOES East RSO data from May 20, 2013, and 10-minute full disk Himawari-8 cloud products from August 1-9, 2015 per requests from UAH.

## **6. CIMSS GOES-R Risk Reduction Program 2015-2016**

### **6.1 Towards Providing Forecasters with Better Identification and Analysis of Severe PyroConvection Events using GOES-R ABI and GLM Data**

**CIMSS Task Leader: Bryan Baum**

**CIMSS Support Scientist: Scott Bachmeier**

**NOAA Collaborators: Andrew Heidinger (NOAA/NESDIS/STAR), Dan Lindsey (NOAA/NESDIS/STAR), Roland Draxler (NOAA Air Resources Laboratory), Timothy Lang (NASA Marshall Space Flight Center), Mark Ruminski (Satellite Analysis Branch, NOAA/NESDIS/SPSD), Gregory Gallina (Satellite Analysis Branch, NOAA/NESDIS/SPSD)**

**Budget: \$94,080**

### **NOAA Long Term Goals:**

- Climate Adaptation and Mitigation
- Weather-Ready Nation



### **NOAA Strategic Goals:**

- Serve society's needs for weather and water
- Support the nation's commerce with information for safe, efficient and environmentally sound transportation
- Provide critical support for the NOAA mission

### **CIMSS Research Themes:**

- Satellite Meteorology Research and Applications
- Satellite Sensors and Techniques
- Education and Outreach

### **Objective**

Investigate the impact of wildfire events that become pyroconvective, resulting in pyroCumulonimbus.

### **Project Overview**

The primary goal of this proposal is to use geostationary satellite data to investigate the impact of wildfire events that become pyroconvective (producing convective cloud plumes which quickly grow to incredible heights, often punching briefly through the tropopause) over the course of several hours and become pyroCumulonimbus, or pyroCb (Fromm et al. 2010). The pyroCb events inject huge amounts of burning emissions into the upper troposphere and even into the lower stratosphere (e.g., Trentmann et al. 2006). The emissions contain soot, mineral dust, and “brown carbon” (or BC; complex light absorbing organic material). The PyroCb blog hosted at CIMSS/SSEC serves as (1) a training resource for undergraduate students to discuss a severe pyroCb event as it unfolds, (2) provides information to NWS forecast offices as well as the general public, and (3) supports scientific research that will eventually make its way into the peer-review literature. More than 60 PyroCb events were documented during 2015, and one undergraduate student in particular (Anna Sienko) was instrumental in keeping up with the unprecedented activity. A number of our blog posts were mentioned on other blogs, which brought an increased level of attention to some of the more severe and noteworthy events. In addition to the blog, a Twitter account @PyroCb\_CIMSS was initiated as another social media tool that can be used to increase the speed that we disseminate pyroCb information to forecasters as well as anyone else with an interest in these events.

### **Milestones with Summary of Accomplishments and Findings**

- Documented over 60 extreme pyroconvection events in 2015; collected pertinent data necessary for detailed case studies and post results on PyroCb blog (<http://pyrocb.ssec.wisc.edu>).
- Continued to improve VISITview module for training purposes.
- Worked with Andrew Heidinger to collect/analyze cloud/aerosol products from geostationary data using the GOES-AWG software.
- Integrated HYSPLIT trajectory software into geostationary satellite imagery analysis.
- Ease transition from GOES-13/15 (and potentially GOES-14) to GOES-R ABI/GLM sensors by working with Himawari-8 data, as we did in 2015 for a number of events.
- Anna Sienko (currently a senior) at UW-Madison built a database of over 120 PyroCb events from 2013-present. She is learning how to analyze these 120 events as part of her senior thesis, and also including analysis of “null” events where pyroconvective development did not transition to PyroCb.
- In preparation for the upcoming 2016 fire season, Anna Sienko is now using GEMPAK to calculate/investigate some additional atmospheric state parameters such as CAPE, the



Haines index, and the mid-tropospheric water vapor. Further meteorological parameters are being explored for potential inclusion and testing.

Our blog continues to track the occurrence of new events: <http://pyrocb.ssec.wisc.edu>. The original intent of the blog was to keep track of pyroCb events beginning with the 2013 fire season so that we have a record of the events for future detailed study. The pyroCb blog continues to evolve as we learn how to integrate other data products with more efficiency and expertise. For quickly-evolving events, information is routinely posted to a Twitter account: @PyroCb\_CIMSS.

A VISITview® training module titled "Satellite Identification and Tracking of Pyrocumulonimbus (PyroCb) Clouds" was developed to assist end-users (for example, National Weather Service forecasters and incident meteorologists or IMETS, US Forest Service wildfire management teams, etc.) in the interpretation of satellite images/products and other tools needed for (1) pyroCb detection, and (2) monitoring long-range transport of the high-altitude smoke aerosols. This module continues to evolve as new information is acquired.

Indications from Lang et al. (2014) are that severe pyro-convection is associated with lightning activity, particularly in the upper part of the cloud. This may be due to the rapid formation and growth of ice particles as the plume reaches the upper troposphere. This convection was associated with rapid wildfire growth, as indicated by incident reports and the presence of shortwave-IR hot spots. For example, electrified pyro-convection was associated with the explosive growth of the Waldo Canyon fire (23 June 2012) that led to the burning of the Mountain Shadows subdivision. Follow-on analysis also established that lightning occurred during the explosive growth at Yarnell Hill in Arizona on 30 June 2013 that led to the deaths of 19 firefighters. This aspect will make progress once the GLM is operational.

Since the beginning of this project in 2013, we have trained a number of undergraduate students in the Atmospheric and Oceanic Science Department in the preparation of geostationary satellite image animations, organization of ancillary data (such as CALIPSO lidar tracks and OMPS aerosol index maps), and participate in preparing blogs describing specific events. Previously, the students were not being asked to perform more complex tasks such as actually working with the cloud products or looking into the scientific questions that come into play for each event. In 2015, one of the students, Anna Sienko, showed exceptional initiative with this effort. She basically did most of the blogging over the 2015 northern hemisphere fire season. In the previous two years (2013-2014), the blog recorded about 20-25 events per year. In 2015, we recorded over 60 events. We ascribe no particular reason for this increase, although a small part of it is that the temporal resolution of Himawari-8 permits us to capture PyroCb events that we could not discern previously. One student in particular, Anna Sienko, decided to learn more about the science by making this work part of her senior thesis at UW-Madison. As part of this work, she organized over 100 PyroCb events based on what has been recorded in the blog. Additionally, she is beginning to develop a Heidke skill score (Petty and Li, 2013) to investigate whether there is some predictive capability for PyroCbs based on meteorological conditions. We recently found that the Heidke skill score depends not only on analyzing PyroCb events, it also depends on having a sizeable null set, i.e., a set of biomass burning events where PyroCbs did not form. We are working to improve the set of biomass burning events where pyroconvection did not occur to mitigate this situation. Anna Sienko has recently been admitted to graduate school in AOS and will pursue a M.S. on this PyroCb work beginning June 1, 2016.

Once Himawari-8 became operational, we began to incorporate the imagery into the pyroCb blog. An example is provided in Figure 20 for a severe fire near Perth, Australia on 6 January, 2016.



This was a particularly devastating fire that burned down most of a small town near Perth, including a favorite pub of one of our CIMSS colleagues, Jim Davies, who's from that region. This serves as a reminder that these extreme events can have a large impact on the affected community. Himawari-8 data were instrumental in being able to capture a number of PyroCb events in 2015. The temporal resolution of the previous imager was generally insufficient to capture the actual PyroCb growth.

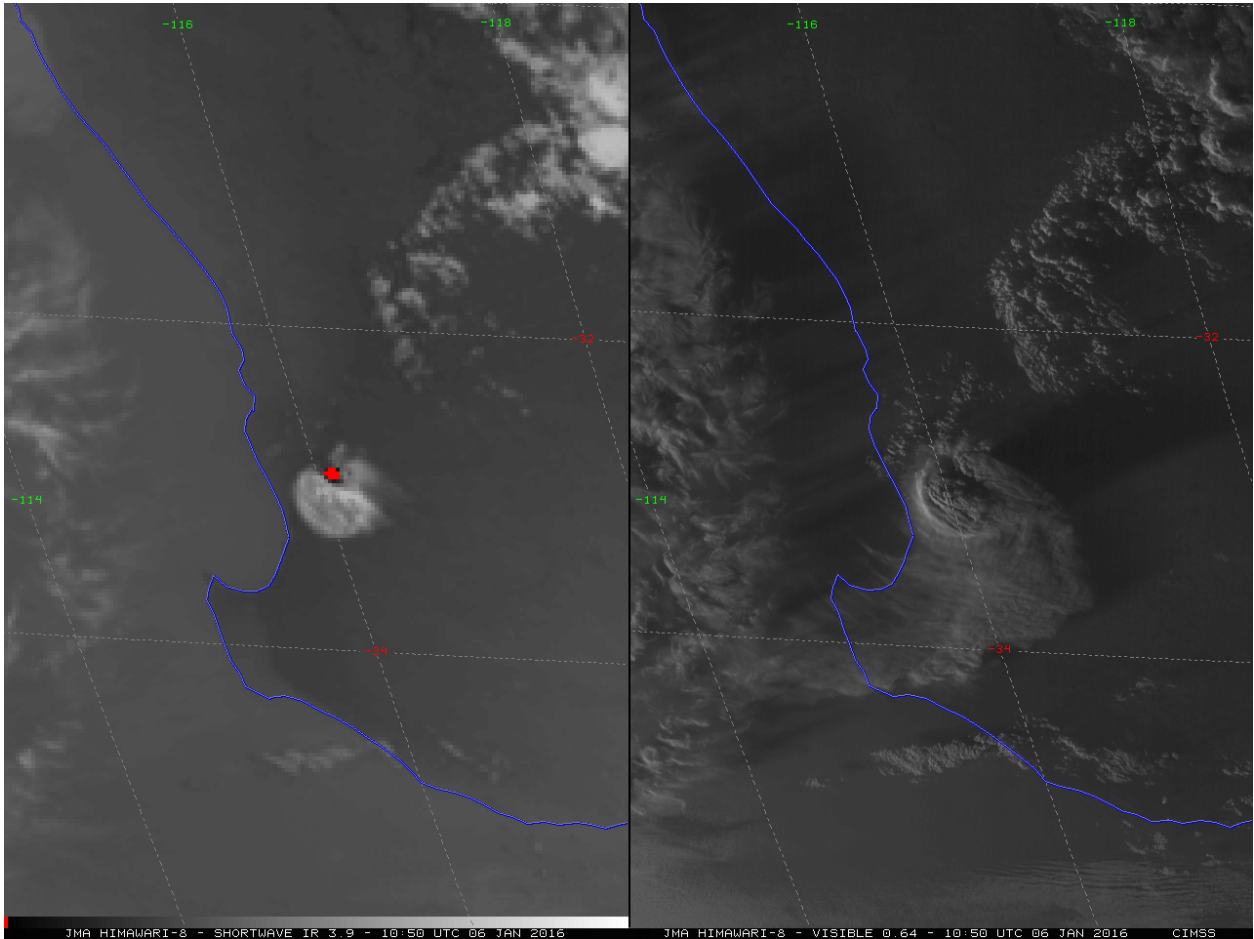

**Figure 20.** The left panel shows the large fire hot spot along with smoke from the fire. The right panel shows the growing pyroCb tower in the visible reflectance image.

## References

Fromm, M., D. T. Lindsey, R. Servranckx, G. Yue, T. Trickl, R. Sica, P. Doucet, and S. Godin-Beekmann, 2010: The untold story of pyrocumulonimbus. *Bull. Amer. Meteor. Soc.*, **91**, 1193–1209.

Lang, T. J., S. A. Rutledge, B. Dolan, P. Krehbiel, W. Rison, and D. T. Lindsey, 2014: Lightning in wildfire smoke plumes observed in Colorado during summer 2012. *Mon. Wea. Rev.*, **142**, 489-507.

Lindsey, D. T. and M. Fromm, 2008: Evidence of the cloud lifetime effect from wildfire-induced thunderstorms. *Geophys. Res. Lett.*, **35**, L22809, doi:10.1029/2008GL035680.



Petty G. W., K. Li, 2012: Improved Passive Microwave Retrievals of Rain Rate over Land and Ocean Part II: Validation and Intercomparison. *Amer. Meteor. Soc.*, **30**, 2509-2526, doi:10.1175/JTECH-D-12-00184.1.

Trentmann, J., G. Luderer, T. Winterrath, M. D. Fromm, R. Servranckx, C. Textor, M. Herzog, H.-F. Graf, and M. O. Andreae, 2006: Modeling of biomass smoke injection into the lower stratosphere by a large forest fire (Part I): Reference simulation. *Atmos. Chem. Phys.*, **6**, 5247–5260, doi:10.5194/acp-6-5247-2006.

## **6.2 Applications of Concurrent Super Rapid Sampling from GOES-14 SRSOR, Radar and Lightning Data**

**CIMSS Task Leader: Mathew Gunshor**

**CIMSS Support Scientist: Joleen Feltz**

**NOAA Collaborators: Tim Schmit, Bob Rabin**

**Budget: \$25,000**

### **NOAA Long Term Goals:**

- Weather-Ready Nation

### **NOAA Strategic Goals:**

- Serve society's needs for weather and water
- Provide critical support for the NOAA mission

### **CIMSS Research Themes:**

- Satellite Meteorology Research and Applications
- Satellite Sensors and Techniques

### **Objective**

The objective of this project is to find novel ways of visualizing new 1-minute GOES-14 data to prepare users for GOES-R ABI 1-minute mesoscale imagery.

### **Project Overview**

The GOES-14 satellite was operated in Super Rapid Scan Operation for GOES-R (SRSOR) mode on several days during 2012, 2013, 2014, and 2015 to demonstrate the value of high temporal observations (1-minute intervals) from GOES. These 1-minute scans will be performed regularly with GOES-R. Researchers see potential in simultaneous high temporal observations (1-minute intervals) from radar, satellite and lightning sensors. The goal of the proposed project was to make use of the currently available GOES-14 Super Rapid Scan data in order to assess and further enhance the utility of the high temporal sampling capability that will be available on GOES-R.

We proposed to demonstrate a prototype “combined” analysis system using data from the GOES-14, MPAR and/or TDWR Doppler radar, and LMA and Earth Networks flash rate data at 1-minute intervals. From the available data, we planned to explore the importance of 1-minute continuity in the identification and tracking of boundaries from radar and visible satellite imagery, their possible influence on convective initiation and any interactions with existing convection. The time continuity of overshooting tops, lightning height and frequency, precipitation intensity, and significant weather events (radar detected mesocyclones, hail signature, etc.) also were investigated. One emphasis was to quantify the improvements in





determining the maxima/minima and temporal trends of overshooting tops that will be provided by the 1-min frequency of satellite imagery from GOES-R.

This project was pursued in collaboration with colleagues at NOAA's National Severe Storms Laboratory (NSSL) and the Cooperative Institute for Research in the Atmosphere (CIRA). The contribution by CIMSS/SSEC primarily involved visualization of multiple data sets combined in McIDAS-V.

### **Milestones with Summary of Accomplishments and Findings**

The proposed milestones for CIMSS were as follows:

- Combined analysis of 1-minute GOES-14, radar (NSSL MPAR and/or TDWR) and lightning (LMA) for May 20-21, 2014 case over Colorado; and
- Transfer of 2015 GOES-14 SRSOR data from SSEC to CLASS, as needed.

Combined analyses of 1-minute GOES-14, radar (NSSL MPAR and/or TDWR) and lightning (LMA) were assembled for a study of severe thunderstorms in Colorado on 20-21 May 2014. Animations were developed showcasing the parallax corrected SRSOR GOES imagery with overlays of LMA frequency, overshooting top location and temperature, radar reflectivity and radial velocity. NSSL scientists put these data into an interactive web-based tool.

- FAA Terminal Doppler Radar (TDWR): low elevation scan reflectivity, radial velocity, and spectrum width were processed at 1-minute intervals for the 20-21 May 2014 study. These data were made available courtesy of the FAA, and were acquired with the help of Aaron Tuttle (FAA/Program Support Facility). They were converted from an internal FAA format to Level-III structured files by Scott Ganson (NOAA/NEXRAD/OSF). Level-III format data archived at the NCDC were only available at 5-minute intervals for the dates of interest.
- Vertically integrated lightning source density during 1-minute intervals detected from the Colorado LMA system (Total LTG) have been processed. These data were provided courtesy of New Mexico Tech University.
- Overshooting top (OT) locations and temperature differential from background anvil were obtained from Kris Bedka (NASA Langley Research Center). These are based on the GOES-R OT algorithm developed by Kris and others at UW-Madison CIMSS. This version of the algorithm uses GOES channel 4 brightness temperatures only for the detection of overshooting tops.
- The multi-sensor wind analysis system (3DVAR) developed at the NOAA National Severe Storms Lab (NSSL) was used to combine radial velocity wind observations from WSR-88D and TDWR Doppler radars and GOES AMVs.
- Multi-sensor displays of the data and the generation of MPEG-4 format movies using McIDAS-V have been explored and developed at University of Wisconsin-CIMSS.

MP4 animations of the GOES, lightning, and radar data were generated at CIMSS using McIDAS-V for a 21 May 2014 supercell storm event near Denver:

[http://cimss.ssec.wisc.edu/~joleenf/srso/2014May21/2014141\\_1930to2357UTC\\_COzoo m.mp4](http://cimss.ssec.wisc.edu/~joleenf/srso/2014May21/2014141_1930to2357UTC_COzoo m.mp4)

This 21 May 2014 case was also used to demonstrate the power of visualizing multiple datasets simultaneously. Total lightning counts, IR brightness temperatures from GOES, and visible reflectance values from GOES can all be shown simultaneously with TDWR radar data overlain.



Multiple satellite products, such as atmospheric wind vectors (AMVs), can also be incorporated. Figure 21 demonstrates this capability for the 21 May 2014 case.

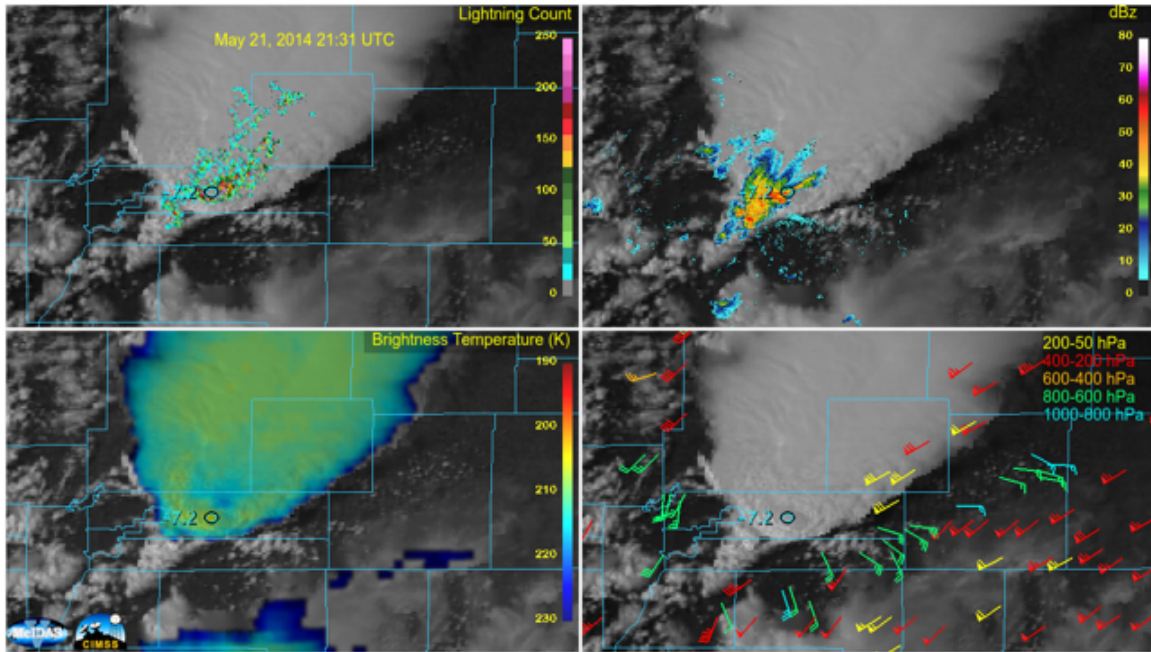

Figure 21. GOES-14 Visible image from May 21, 2014 (21:31 UTC) with accumulated lightning counts (upper left), TDWR radar (upper right), IR brightness temperatures in a "sandwich product" display (lower left), and satellite derived winds (lower right).

### Publications and Conference Reports

“Using McIDAS-V with the next Generation of Satellite Sensors” by Joleen Feltz, M. Gunshor, R. Rabin, and T. Schmit. Presented at the 32nd Conference on Environmental Information Processing Technologies, session on Visualization Techniques for Climatology and Meteorology, 96th American Meteorological Society (AMS) annual meeting on 12 January 2016.

### 6.3 Development and Optimization of Mesoscale Atmospheric Motion Vectors (AMVs) using Novel GOES-R Processing Algorithms on 1-5 min. SRSO Proxy Data, and Demonstration of Readiness for GOES-R Applications via Impact Studies in Mesoscale Data Assimilation and NWP Systems

**CIMSS Task Leader: Chris Velden**

**CIMSS Support Scientist: Dave Stettner**

**NOAA Collaborators: Jaime Daniels, Vijay Tallapragada**

**Budget: \$75,000**

#### NOAA Long Term Goals:

- Weather-Ready Nation

#### NOAA Strategic Goals:

- Serve society’s needs for weather and water
- Provide critical support for the NOAA mission

#### CIMSS Research Themes:

- Satellite Meteorology Research and Applications



- Satellite Sensors and Techniques
- Environmental Models and Data Assimilation

### **Objective**

Optimize the GOES-R Derived Motion Vector algorithm for processing of mesoscale datasets and applications to short-term forecasts and NWP.

### **Project Overview**

One of the principle benefits expected from GOES-R is the improvement in temporal sampling of images from the ABI. In addition to qualitative uses by forecasters, the rapid refresh (1-5 min.) should allow for quantitative improvements in derived products normally associated with geostationary satellite imagery. One of those products is atmospheric motion vectors, or AMVs. Derived by tracking coherent cloud motions in successive VIS/IR images, AMVs have long stood as an important contributor of tropospheric wind information to analyses on the global scale. GOES-R will allow superior cloud-tracking and AMV generation on time scales not only useful for global applications, but for mesoscale applications as well.

The reasons we are optimistic that GOES-R AMVs can be an important contributor to mesoscale analyses derive from recent and ongoing studies. This work builds on these pioneering efforts as we also take advantage of GOES-R capabilities and new AMV derivation methods. Our objective is to apply these to the production of mesoscale AMV datasets to extract wind information that benefits short-term forecasts and NWP.

### **Milestones with Summary of Accomplishments and Findings**

Milestone 1. Forecast impact experiments with the RAP/HRRR models for the two identified severe weather cases (a flooding event in Texas, and an EF-3 tornado event in Colorado, both in May – June 2015) are now being conducted with assimilation of the heritage mesoscale AMVs (Benchmark dataset). The Benchmark AMVs have been successfully assimilated within the 13-km RAP, and a control run (without the assimilation) has been conducted. Selected results from the RAP analyses are shown in the figure below. From a quick, preliminary examination, the Benchmark AMVs generally show minor initial analysis impacts. The next step will be to run the HRRR model forecast experiments using the RAP with AMV assimilation to provide initial and boundary conditions, to see if the forecasts result in better convective evolution.

Milestone 2. The GOES-R AMV algorithm settings, tuning, and QC procedures for mesoscale processing are being optimized to increase the data density and improve the ultimate quality. This process involves empirical testing and statistical validation of the AMVs, as well as additional model forecast impact experiments in Year 3 of this project.



CIMSS Cooperative Agreement Report  
1 July 2015 – 31 March 2016

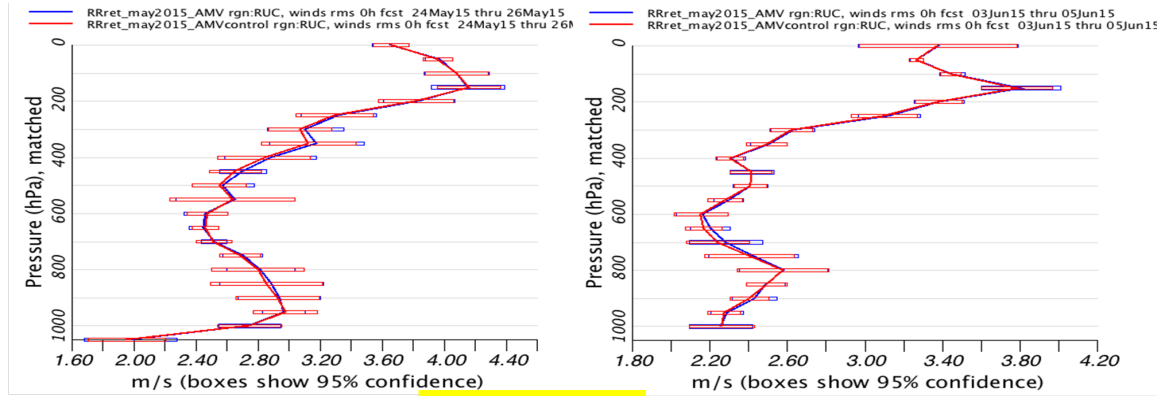

Wind RMSE profiles for 0-h fcsts, RUC domain  
Case 1: 24-26 May 2015  
Retro with AMV assimilation  
Control retro with no AMV assimilation

Small degradation seen at most levels with AMV assimilation

Wind RMSE profiles for 0-h fcsts, RUC domain  
Case 2: 3-5 June 2015  
Retro with AMV assimilation  
Control retro with no AMV assimilation

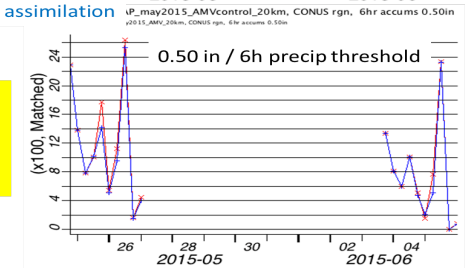
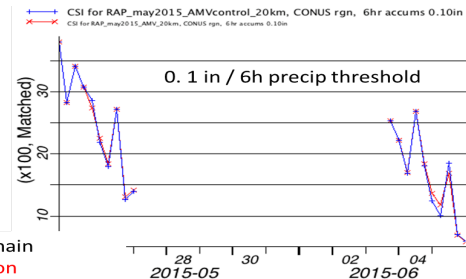
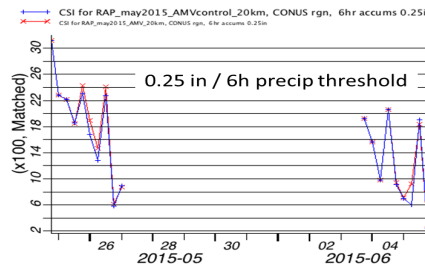
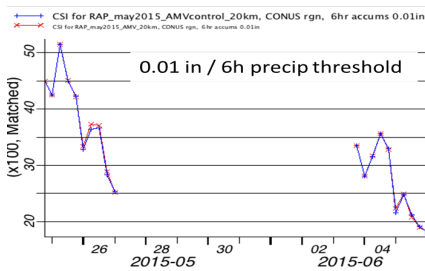

6-h precip CSI, CONUS domain  
Retro with AMV assimilation  
Control retro with no AMV assimilation

Slight improvement in precipitation Critical Success Index (CSI) for all precip thresholds with AMV assimilation

Figure 22. Forecast impact experiments with the RAP model for two selected severe weather cases (flooding event in Texas, and EF-3 tornado event in Colorado, both in May-June 2015) were conducted with assimilation of the heritage mesoscale AMVs (Benchmark dataset) and compared with a control run (without assimilation). Selected results from RAP analyses are shown above.

### Publications and Conference Reports

Velden, C., J. Daniels, W. Bresky, S. Wanzong, 2015: High-resolution AMVs for applications in high-impact weather events in the GOES-R era. 2015 NOAA Satellite Science Week.

### 6.4 Development of a Near Real-time Satellite Verification and Forecaster Guidance System for the High-Resolution Rapid Refresh (HRRR) Model

CIMSS Task Leaders: Jason Otkin and Justin Sieglaff

CIMSS Support Scientists: Sarah Griffin and Lee Counce

NOAA Collaborators: Steve Weiss, Steve Weygandt, David Bright, and Bruce Entwistle

Budget: \$109,933 (FY16)

### NOAA Long Term Goals:

- Weather-Ready Nation



### **NOAA Strategic Goals:**

- Serve society's needs for weather and water

### **CIMSS Research Themes:**

- Satellite Meteorology Research and Applications
- Environmental Models and Data Assimilation

### **Objective**

The primary objectives of this project are to develop a satellite-based forecast verification system for the High-Resolution Rapid Refresh (HRRR) model that will provide operational forecasters objective tools to quickly determine the accuracy of the many overlapping HRRR forecast cycles at the current time and to use the simulated brightness temperatures to thoroughly assess the long-term accuracy of the forecast cloud and water vapor fields.

### **Project Overview**

For this project, we will develop a near real-time satellite-based forecast verification system for the HRRR model. Synthetic GOES infrared brightness temperatures will be generated for each HRRR model forecast cycle using the Community Radiative Transfer Model (CRTM), and will then be compared to real GOES observations using multiple techniques, including traditional grid point statistics, neighborhood verification methods, brightness temperature differences, and probability distributions. These methods will be used to examine the accuracy of the simulated cloud and water vapor fields at each model forecast time. Because forecast skill often varies with space and time, the statistics will be computed for pre-defined regions covering the contiguous U.S. in a manner similar to that used on the Storm Prediction Center (SPC) mesoscale analysis webpage. New verification metrics will also be developed to combine information from the various statistical methods to produce an overall accuracy “score” and ranking for each forecast cycle. A web-based interface will be developed that will allow forecasters to click on a specific geographic region, and then choose which forecast cycles to examine more closely based on the automated rankings. Simulated brightness temperatures accumulated over long time periods will then be used to assess the overall accuracy of the forecast cloud and water vapor fields.

### **Milestones with Summary of Accomplishments and Findings**

- *Evaluate the utility of the forecast analysis system and verification webpage*  
The real-time forecast verification system (<http://cimss.ssec.wisc.edu/hrrrval/>) was demonstrated at the 2015 Aviation Weather Testbed Summer Experiment in Kansas City, MO. Feedback from participants, including operational aviation weather forecasters and numerical weather prediction model developers, was generally positive. Forecasters found the side-by-side animations of the observed and simulated GOES satellite imagery shown on the webpage for each forecast cycle to be very valuable as a forecasting aid and because they allow them to circumvent the single-panel restriction of N-AWIPS that prevents them from easily comparing model-simulated and observed satellite imagery. Model developers appreciated how the simulated satellite imagery could be used to quickly detect biases in the forecast cloud and water vapor fields.
- *Assessing HRRR forecast accuracy using object-based verification methods*  
We began to explore the use of object-based verification methods to assess the accuracy of the HRRR model forecasts. To learn how to use object-based verification, J. Otkin wrote a visiting scientist proposal to the Developmental Testbed Center (DTC) that was approved in April 2015. Three members of the research team (J. Otkin, S. Griffin, and C. Rozoff) subsequently spent 1 to 2 weeks as visiting scientists at the DTC to meet with

developers of the Method for Object-based Diagnostic Evaluation (MODE) tool to learn how to use that system for object-based verification. Only one prior study has used object-based verification with satellite brightness temperatures so substantial effort is still required to optimize the use of this method with satellite observations. Numerous sensitivity experiments were conducted to determine suitable MODE parameters that can be used to identify useful cloud objects observed in satellite infrared imagery. For example, experiments were performed using a different convolution radius, which is a smoothing operator applied to the brightness temperatures, to identify cloud features with different spatial extents. Figure 23 shows a representative example of cloud objects identified in the GOES observed (left side) and HRRR forecast (right side) satellite imagery for a single forecast time. Efforts are currently underway to optimize use of this method for assessing the accuracy of the forecast cloud field.

- *Prepare peer-reviewed article describing project results*  
We are writing a journal article describing results from our model validation efforts using the neighborhood-based Fractions Skill Score (FSS), traditional grid point statistics, and object-based verification methods. This paper will focus on a case study from 23 July 2015 that contained different modes of convection across different parts of the U.S. and will be used to evaluate the merits of each verification method.

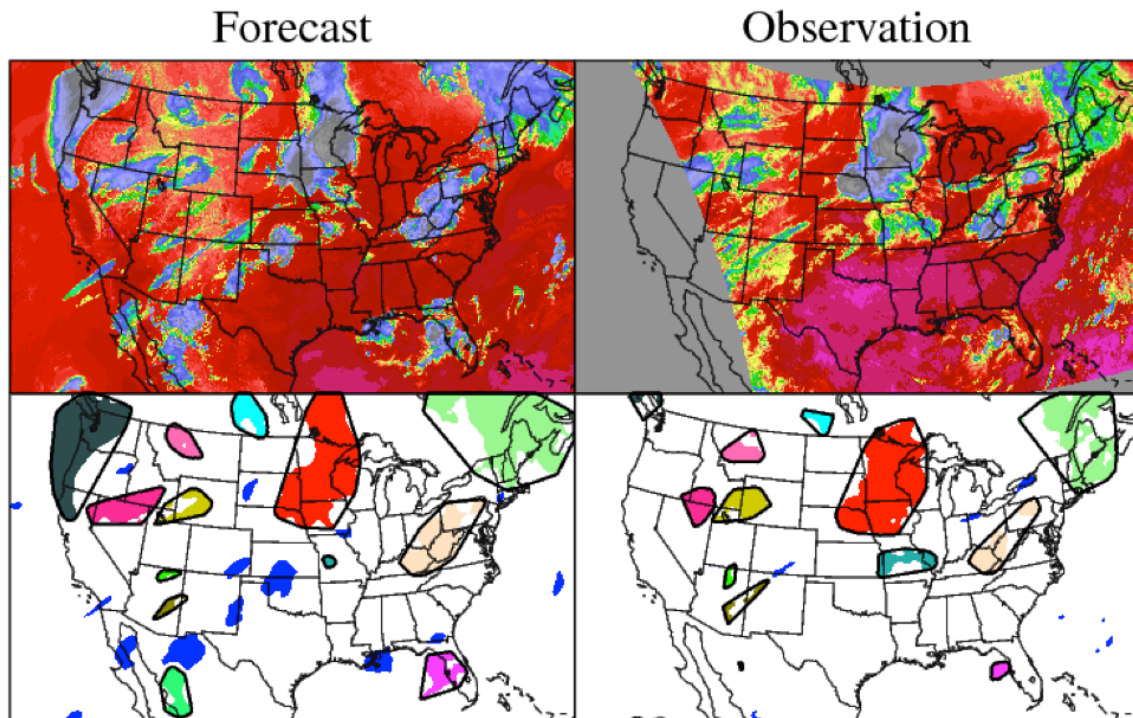

**Figure 23.** (top panels) Simulated and observed GOES 10.7  $\mu\text{m}$  brightness temperatures valid at 07 UTC on 18 July 2015. The simulated brightness temperatures are from a 6-hour HRRR model forecast starting at 01 UTC on 18 July 2015. (bottom panels) Cloud objects identified by MODE using the simulated and observed brightness temperatures. Matching cloud objects in the forecast and observations are encircled by thick black lines. A brightness temperature threshold of 250 K and a convolution radius of 15 km (five model grid points) were used to identify the cloud objects. The GOES brightness temperatures were remapped to the HRRR model projection prior to running MODE.



## **Publications and Conference Reports**

Griffin, S. M., J. A. Otkin, C. M. Rozoff, J. M. Sieglaff, L. M. Counce, and C. Alexander, 2016: Methods for comparing simulated and observed satellite infrared brightness temperatures and what do they tell us? In preparation for submission to Wea. Forecasting.

Otkin, J. A., J. Sieglaff, S. Griffin, L. M. Counce, and C. R. Alexander, 2016: Development of a GOES-based verification and forecaster guidance system for the High-Resolution Rapid Refresh model. 12th Annual Symposium on New Generation Operational Environmental Satellite Systems. New Orleans, LA.

Otkin, J. A., J. Sieglaff, S. Griffin, L. Counce, and C. Alexander, 2015: Development of a GOES-based verification and forecaster guidance system for the High-Resolution Rapid Refresh model. 2015 EUMETSAT Meteorological Satellite Conference, Toulouse, France.

## **6.5 Development of Realtime All-weather Layer Precipitable Water Products in AWIPS II by Fusing the GOES-R and NWP for Local Forecasters**

**CIMSS Task Leader: Jun Li**

**CIMSS Support Scientists: Jordan Gerth, Zhenglong Li, and Scott Bachmeier**

**NOAA Collaborators: William Line, SPC/HWT - GOES-R Satellite Liaison; Jeff Craven, NWS Forecast Office, Milwaukee/Sullivan, WI; Tim Schmit, NOAA/NESDIS/STAR**

**Budget: \$98,000**

### **NOAA Long Term Goals:**

- Climate Adaptation and Mitigation
- Weather-Ready Nation

### **NOAA Strategic Goals:**

- Serve society's needs for weather and water
- Understand climate variability and change to enhance society's ability to plan and respond
- Provide critical support for the NOAA mission

### **CIMSS Research Themes:**

- Satellite Meteorology Research and Applications

### **Objective**

The objective is to develop the GOES/GOES-R near real time all-weather layer precipitable water products in AWIPS II by fusing the GOES-R and NWP for local forecasters.

### **Project Overview**

Observations of moisture transportation in pre-convection environment and during storm development are very useful for forecasters. NOAA's new generation of Geostationary Operational Environmental Satellite (GOES-R) series provides high temporal (every 5 minutes) and spatial (2 km) resolution moisture information not seen before. Since there will be no sounder onboard the GOES-R series, the GOES-R ABI will be used to continue the current GOES Sounder legacy atmospheric profile (LAP) products. However, the current operational GOES Sounder and the next GOES-R LAP products are only available in clear skies. Extending the use of IR measurements into cloudy regions would increase the completeness of moisture



information. In typical scenes, completely clear-sky observations from the infrared (IR) observations are available for only 10 – 50% of the image, depending on the spatial resolution. Studies show that cloudy regions are responsible for the development of error in NWP forecasts (McNally 2002) and exhibit more forecast error than clear skies. Building on the GOES-R LAP algorithm, CIMSS scientists and NOAA collaborators propose to develop all-weather real time layered precipitable water (LPW) analyses and implement them into the Advanced Weather Interactive Processing System (AWIPS-II) to allow operational meteorologists to monitor a controlling ingredient in the initiation, development, and decay of convective cells and systems. The unique LPW products have the advantages of availability in all sky and weather conditions. Three layered PW products with flexible spatial (2 – 10 km) and temporal (5 minutes – 1 hour) resolution will be developed, which will supplement the operational GOES-R LAP products for applications.

## **Milestones with Summary of Accomplishments and Findings**

### ***All-sky GOES-R TPW and LPW Algorithms Applied Successfully to Process Advanced Himawari Imager (AHI) IR Radiance Measurements (July – November 2015)***

The AHI onboard the Himawari-8 has the similar IR bands of ABI; CIMSS sounding team have applied the all-weather LAP algorithms to process ABI also, and the LAP product generation from AHI in NRT at CIMSS now. The AHI LAP product generation with GOES-R all-sky TPW/LPW algorithms is now running in near real time (NRT) at CIMSS, hourly all-sky TPW/LPW products at full disk coverage with 10 km resolution are now available in NRT. The all-sky TPW/LPW products from AHI at selected region have been put into AWIPS-II so that forecasters can access in NRT for Proving Ground (PG) applications in Pacific region. Initial validation with high resolution (0.25o x 0.25o) operational ECMWF analysis indicates that the all-sky TPW/LPW products meet the requirement for applications, more validations are ongoing.

### ***All-weather Algorithm Applied to INSAT-3D Sounder (October 2015 – February 2016)***

INSAT-3D sounder has the similar characteristics and instrument specification as U.S. GOES Sounder. CIMSS sounding team have applied the all-weather LAP algorithm to INSAT-3D. The algorithm includes: the INSAT-3D PFAAST type radiative transfer model developed at CIMSS in clear skies and UW-Madison cloudy radiative transfer model for cloudy skies. The operational GOES-R AWG LAP algorithm is applied to derive INSAT-3D soundings in clear skies while the GOES-R3 algorithm developed under support of this project is adopted for INSAT-3D LAP retrieval under cloudy skies. The inputs include INSAT-3D IR counts (converted to brightness temperatures), and GFS forecasts (could be other NWP model forecasts), while the outputs include the atmospheric temperature and moisture profiles, TPW and 3 layer PW, atmospheric instability indices, cloud-top pressure, optical thickness, and retrieval quality flags. Figure 24 shows example of TPW retrieval from INSAT-3D. Animation and more examples can be seen from the following PPT:

[ftp://ftp.ssec.wisc.edu/ABS/AWG/insat\\_3d\\_RTVL\\_example.pptx](ftp://ftp.ssec.wisc.edu/ABS/AWG/insat_3d_RTVL_example.pptx)



## INSAT-3D sounding retrieval - TPW

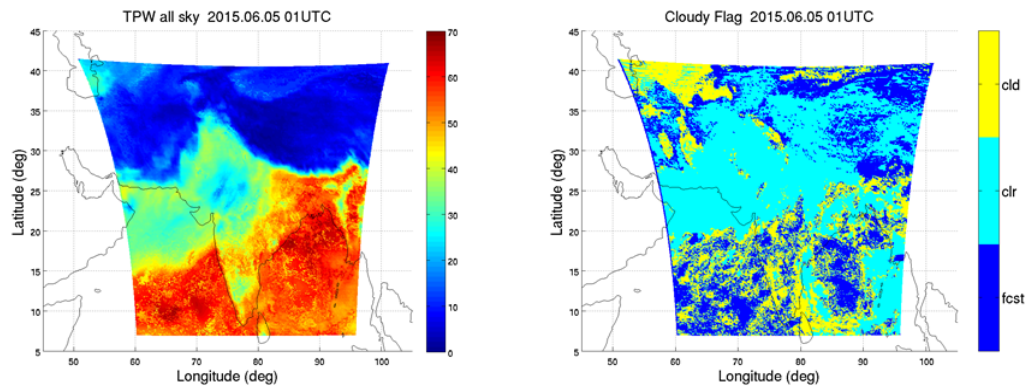

**Figure 24.** Example of TPW retrieval from INSAT-3D at 01 UTC on 05 June 2015. The left panel shows TPW retrievals in mm. The right panel shows the clear/cloudy flags for retrievals.

### Publications and Conference Reports

Lee, Yong-Keun, Jun Li, Zhenglong Li, and Timothy Schmit, 2016: Application of GOES-R ABI LAP algorithm to AHI onboard Himawari-8, 96th American Meteorological Society Annual Meeting, New Orleans, LA, 10-14 January 2016.

Wang, P., Jun Li, et al., 2015: The Impact of the High Temporal Resolution GOES/GOES-R Moisture Information on Severe Weather Systems in Regional NWP model, The 20th International TOVS Conference (ITSC-20), 28 October – 03 November 2015, Lake Geneva, Wisconsin, U.S.A.

Wang, Pei, Jun Li, Yong-Keun Lee, Zhenglong Li, Jinlong Li, Zhiquan Liu, Tim Schmit and Steve A. Ackerman, 2016: The Impact of the High Temporal Resolution GOES and GOES-R Moisture Information on Severe Weather Systems in a Regional NWP Model, 96th American Meteorological Society Annual Meeting, New Orleans, LA, 10-14 January 2016.

### References

Borbias, E., S. Seemann, H.-L. Huang, J. Li, and W. P. Menzel (2005), Global profile training database for satellite regression retrievals with estimates of skin temperature and emissivity, 14th International ATOVS Study Conference, Beijing.

Doswell, C. A., III, 1987: The distinction between large-scale and mesoscale contribution to severe convection: A case study example. *Wea. Forecasting*, 2, 3–16.

Jin, X., J. Li, T. J. Schmit, J. Li, M. D. Goldberg, and J. J. Gurka, 2008: Retrieving clear-sky atmospheric parameters from SEVIRI and ABI infrared radiances, *J. Geophys. Res.*, 113, D15310, doi:10.1029/2008JD010040.

Jin, X., J. Hanesiak, and D. Barber, 2006: Detecting cloud vertical structures from radiosondes and MODIS during CASES field experiment. *Atmos. Res.*, 83, 64–76



Li, J., C.-Y. Liu, P. Zhang, and T. J. Schmit, 2012: Applications of Full Spatial Resolution Space-Based Advanced Infrared Soundings in the Preconvection Environment, *Weather and Forecasting*, 27, 515 - 524.

Li, J., Jinlong. Li, J. Otkin, T. J. Schmit, and C. Liu, 2011: Warning information in a preconvection environment from the geostationary advanced infrared sounding system - A simulation study using IHOP case, *J. of Applied Meteorology and Climatology*, 50, 776 - 783.

Li, Z., J. Li, W. P. Menzel, T. J. Schmit, J. P. Nelson, III, J. Daniels, and S. A. Ackerman, 2008: GOES sounding improvement and applications to severe storm nowcasting, *Geophys. Res. Lett.*, 35, L03806, doi:10.1029/2007GL032797.

Li, Z., J. Li, W. P. Menzel, J. P. Nelson III, T. J. Schmit, Elisabeth Weisz, and S. A. Ackerman, 2009: Forecasting and nowcasting improvement in cloudy regions with high temporal GOES Sounder infrared radiance measurements, *Journal of Geophysical Research. - Atmospheres*, 114, D09216, doi:10.1029/2008JD010596.

Schmit, T. J., M. M. Gunshor, W. Paul Menzel, J. Gurka, J. Li, and S. Bachmeier, 2005: Introducing the next-generation advanced baseline imager (ABI) on GOES-R. *Bull. Amer. Meteorol. Soc.*, 86, 1079-1096.

Seemann, S., E. Borbas, R. Knuteson, H.-L. Huang, and G. R. Stephenson, and H. – L. Huang (2008), Development of a global infrared land surface emissivity database for application to clear sky sounding retrievals from multispectral satellite radiance measurements, *J. Appl. Meteorol.*, 47, 108 - 123.

Smith, W. L., E. Weisz, S. V. Kireev, D. K. Zhou, Z. Li, E. E. Borbas (2012), Dual-Regression Retrieval Algorithm For Real-time Processing of Satellite Ultraspectral Radiances. *J. Appl. Meteorol. Clim.*, 51, 1455-1476.

## **6.6 Using Multi-Sensor Observations for Volcanic Cloud Detection, Characterization, and Improved Dispersion Modeling**

**CIMSS Task Leader: Justin Sieglaff**

**CIMSS Support Scientist: John Cintineo**

**NOAA Collaborator: Mike Pavolonis**

**Budget \$72K**

### **NOAA Long Term Goals:**

- Weather-Ready Nation

### **NOAA Strategic Goals:**

- Serve society's needs for weather and water
- Support the nation's commerce with information for safe, efficient and environmentally sound transportation
- Provide critical support for the NOAA mission

### **CIMSS Research Themes:**

- Satellite Meteorology Research and Applications
- Satellite Sensors and Techniques



- Environmental Models and Data Assimilation

### **Objective**

We will continue to develop an advanced volcanic ash detection and characterization system and ensure results of the system can be integrated into volcanic ash dispersion models.

### **Project Overview**

GOES-R will provide unprecedented capabilities to detect and track hazardous volcanic clouds. These capabilities, however, will only be fully realized using automated algorithms as the impressive GOES-R data volume makes volcanic eruption detection, solely using manual analysis of imagery, impossible. To ensure that the full spectral, spatial, and temporal capabilities of GOES-R are utilized for volcanic cloud monitoring, the Volcanic Cloud Analysis Toolkit (VOLCAT) was developed. VOLCAT utilizes spectral, spatial, and temporal metrics provided by GOES-R to detect and characterize volcanic ash clouds (VOLCAT can actually be applied to nearly any geostationary or low earth orbit sensor). We propose to build upon previous research by incorporating additional key data sources into VOLCAT, performing several case studies, and developing an application that utilizes VOLCAT to improve operational volcanic ash dispersion modeling. This proposal directly addresses NWS research priorities A (improved model forecasts) and B (improved situational awareness) and is a natural progression of a pre-existing line of (successful) research. The proposed research will directly address several operational challenges associated with tracking and forecasting volcanic clouds, which are a well-known aviation hazard. NOAA operates two Volcanic Ash Advisory Centers (VAACs) and three Meteorological Watch Offices (MWO) with operational volcanic hazard monitoring and forecasting responsibilities. NOAA's total area of responsibility covers a very large region that stretches from the Western Pacific to the Eastern Caribbean and from Alaska to Ecuador. Thus, volcanic cloud monitoring and forecasting is an important component of NOAA operations.

### **Milestones with Summary of Accomplishments and Findings**

- Improved VOLCAT to better track volcanic clouds from start to dissipation. The improved volcanic cloud tracking is essential for 1) temporal continuity in product accuracy as demanded by VAAC operations and dispersion modelling applications and 2) accurate alerting on new volcanic clouds during periods of prolonged volcanic unrest.
- Based on favourable feedback from the Washington and Anchorage VAACs, we have opened the alerting tool to a broader range of users, including international VAACs. Figure 25 shows a recent example of the Washington VAAC's use of a near real-time VOLCAT alert.
- Nearly completed a peer-reviewed journal article entitled, "Automated Detection of Explosive Volcanic Eruptions Using Satellite-derived Cloud Vertical Growth Rates".
- Developed "puff" logic within VOLCAT to detect volcanic eruptions that have marginal spectral signatures and marginal cloud growth rates.
- Co-Is at the USGS have continued to develop techniques for integrating VOLCAT alerts into USGS/AVO visualization systems and indicate the alerts help assist USGS/AVO evaluate volcanic activity.



### Volcanic Cloud Alert Report

DATE:	2016-01-20
TIME:	18:47:38
Production Date and Time:	2016-01-20 19:55:05 UTC
PRIMARY INSTRUMENT:	Aqua MODIS

[More details](#)

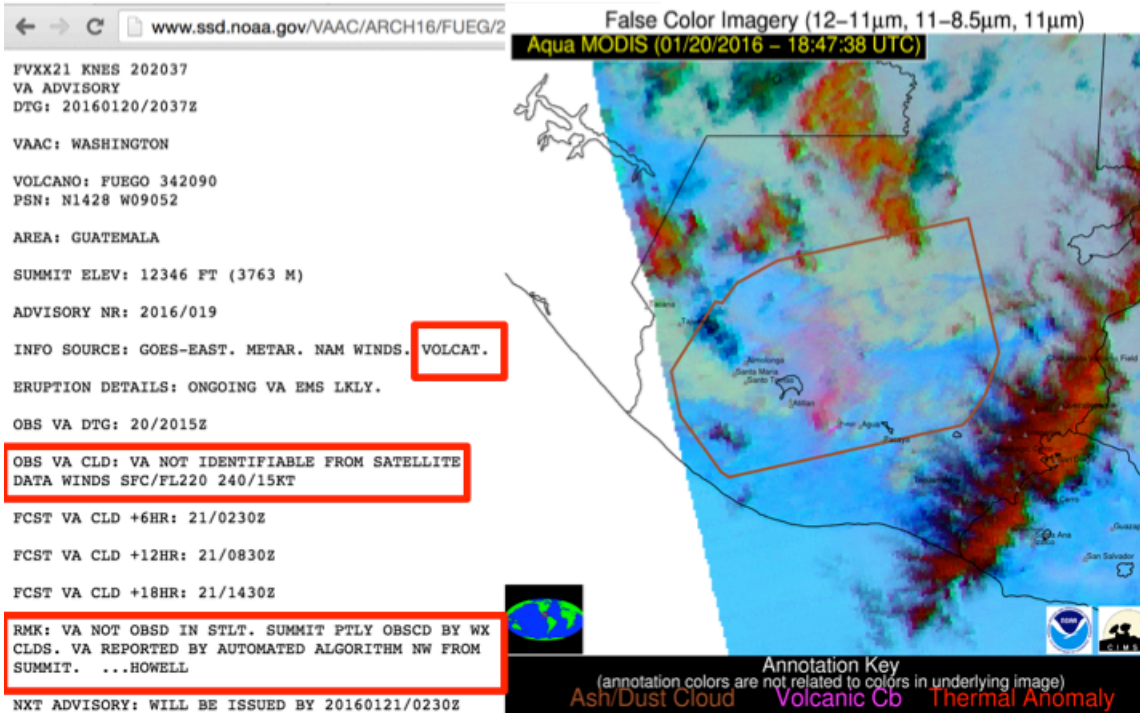
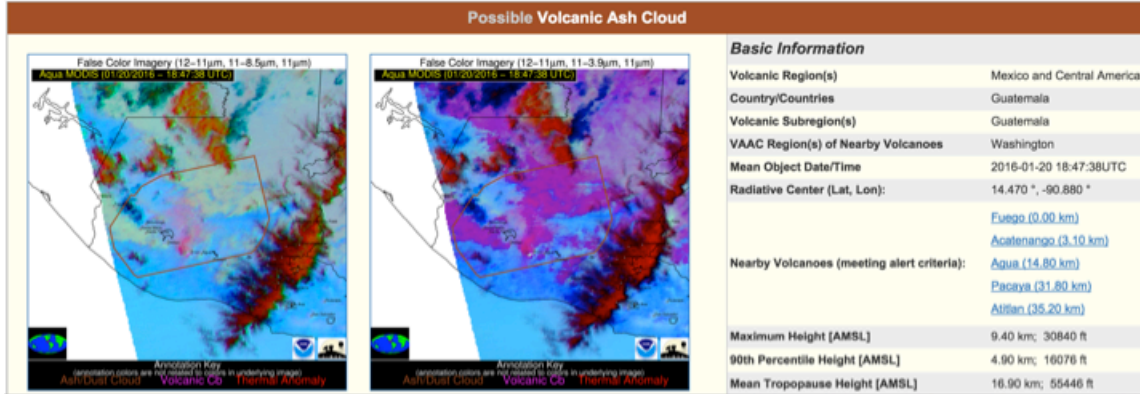

Figure 25. A screenshot of a near-real-time VOLCAT ash alert associated with an eruption of Fuego (Guatemala) on January 20, 2016 is shown in the top panel. The Washington VAAC utilized this alert to issue a Volcanic Ash Advisory (bottom, left panel). A more detailed view of the ash detected by VOLCAT is shown in the bottom, right panel. The VOLCAT products provided unique information, as the Fuego ash cloud was not unambiguously identifiable in the standard satellite products utilized by the Washington VAAC.

### Publications and Conference Reports

Pavlonis, M. J., J. Sieglaff, and J. Cintineo (2015a), Spectrally Enhanced Cloud Objects (SECO): A Generalized Framework for Automated Detection of Volcanic Ash and Dust Clouds using Passive Satellite Measurements, Part I: Multispectral Analysis, *J. Geophys. Res. Atmos.*, 120, doi:[10.1002/2014JD022968](https://doi.org/10.1002/2014JD022968).



Pavolonis, M. J., J. Sieglaff, and J. Cintineo (2015b), Spectrally Enhanced Cloud Objects (SECO): A Generalized Framework for Automated Detection of Volcanic Ash and Dust Clouds using Passive Satellite Measurements, Part II: Cloud Object Analysis and Global Application, *J. Geophys. Res. Atmos.*, 120, doi:[10.1002/2014JD022969](https://doi.org/10.1002/2014JD022969).

Pavolonis, M. J., A. K. Heidinger, and J. Sieglaff (2013), Automated retrievals of volcanic ash and dust cloud properties from upwelling infrared measurements, *J. Geophys. Res. Atmos.*, 118, doi:[10.1002/jgrd.50173](https://doi.org/10.1002/jgrd.50173).

## References

Pavolonis, M. J., 2010: Advances in extracting cloud composition information from spaceborne infrared radiances: A robust alternative to brightness temperatures. Part I: Theory. *J. Applied Meteorology and Climatology*, **49**, 1992-2012.

## 6.7 Assimilation and Forecast Impact of High Temporal Resolution Leo/Geo AMVs in the High-Latitude Data-Gap Corridor

**CIMSS Task Leader: Brett Hoover**

**CIMSS Support Scientist: David Santek, Matthew Lazzara, Jeff Key, Anne Sophie Daloz**

**NOAA Collaborator: Andrew Collard, Jaime Daniels**

**Budget: \$102,930**

### NOAA Long Term Goals:

- Weather-Ready Nation

### NOAA Strategic Goals:

- Serve society's needs for weather and water

### CIMSS Research Themes:

- Satellite Meteorology Research and Applications
- Satellite Sensors and Techniques
- Environmental Models and Data Assimilation

## Objective

Assimilate Leo/Geo AMVs in the GDAS and identify impact on the GFS forecast

## Project Overview

The goals of the project are to assimilate atmospheric motion vectors (AMVs) from combined low- Earth-orbiting/geostationary data, referred to as LEO/GEO AMVs, which are generated in the sparsely sampled region between 60-70 degrees latitude in the northern and southern hemispheres. Our interests are: (1) Providing a comprehensive analysis of how to reconcile quality control between AMVs from low-Earth-orbiting (polar) satellites and from geostationary satellites, which have been treated differently for some time. Where these data are blended in the data-gap corridor, a reconciliation of quality control techniques is warranted. (2) Determine the analysis and forecast impact of assimilating LEO/GEO AMVs in the GDAS/GFS. Since the data-gap corridor is a region that is sparsely sampled, the analysis has historically relied heavily on the model background; introducing LEO/GEO AMVs may require some careful considerations for quality control to account for this. We wish to investigate the analysis-impact on radiosonde and non-radiosonde analysis periods separately to see if there is any significant difference in



assimilation, as well as examine model forecast bust events, which previous research has shown to be where LEO/GEO AMVs can provide the most impact.

### **Milestones with Summary of Accomplishments and Findings**

Milestones for this period include:

1. Provide script and software modifications necessary to transition the assimilation of LEO/GEO AMVs to NCEP/EMC via subversion,
2. Complete a 2-season DA experiment and investigate forecast dropout case studies,
3. Complete generation of DA and forecast impact statistics,
4. Complete draft of refereed paper, and
5. Develop presentation/report for Annual JCSDA Workshop.

Recent developments have imposed restrictions on the algorithms used to produce AMVs for NOAA operations – these restrictions require significant re-writing of the LEO/GEO AMV algorithm and work has begun on making LEO/GEO AMV production compliant for operations. In the mean time, NCEP/EMC has expressed an interest in using CIMSS-produced LEO/GEO AMVs as a “dataset of opportunity”, similar to ECMWF operations. Two experiments have been completed since the last report: a second-season experiment from 01 December 2014 – 06 February 2015 utilizing existing quality-control of high latitude AMVs, and an experiment over the original 01 April 2014 – 30 May 2014 experiment utilizing quality control based on criteria specific to LEO/GEO AMVs.

Impact on 500 hPa geopotential height anomaly correlation is neutral in both hemispheres for the second season experiment (Figure 26), but impact on 500 hPa wind bias is improved in both hemispheres out to day-4 or day-5 to 95% statistical significance (Figure 27).

The quality-control experiment reduces assumed observation error for LEO/GEO winds that are composed of image triplets that have: (1) fewer than three satellites, and (2) a LEO middle-image, used to define height assignment. Assumed observation error was reduced by 50% for winds meeting these criteria, and the warm season experiment from 01 April 2014 – 30 May 2014 was repeated under this new LEO/GEO AMV QC. Impact is not improved over existing quality control (not shown).

Efforts are underway to bring the LEO/GEO wind algorithm into compliance with requirements recently added by NOAA. We also plan to perform composites of initial (analysis) states for forecasts that are significantly improved (or degraded) by assimilation of LEO/GEO AMVs, as well as regression of forecast error onto the initial state, for various lead-times. This work is expected to produce dynamical understanding of the impact of LEO/GEO AMVs on the forecast, which will be included with the collected forecast skill scores in a future JCSDA Workshop presentation and peer-reviewed publication. Additional experiments modifying quality-control of LEO/GEO AMVs will be performed as needed.

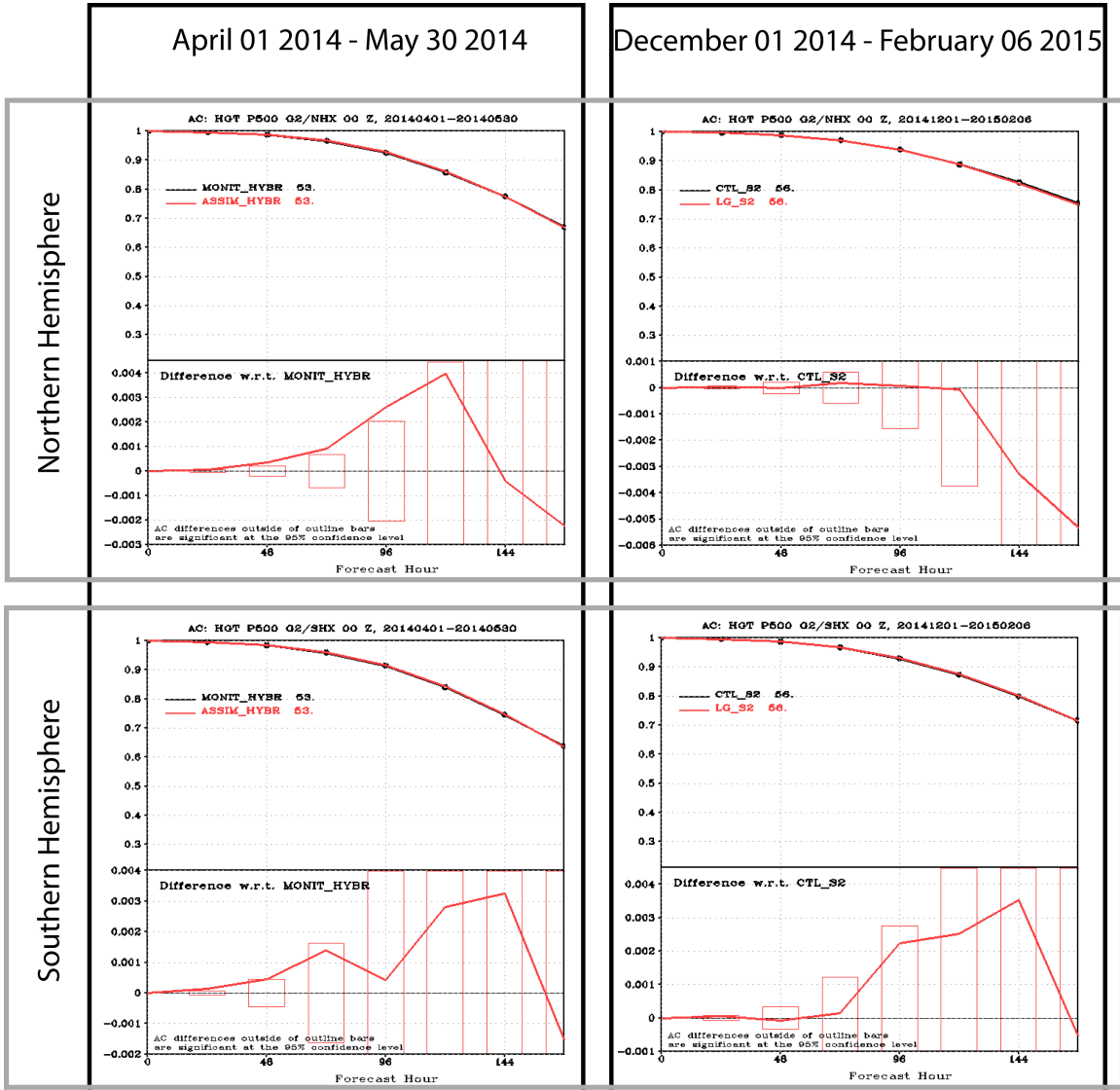

Figure 26. Mean 500 hPa geopotential height anomaly correlation scores for LEO/GEO experiments from (left) 01 April 2014 – 30 May 2014 and (right) 01 December 2014 – 06 February 2015, for the (top) northern hemisphere and (bottom) southern hemisphere. All four panels show in the top half the mean correlation die-off curve for the control in black and the experiment in red, and in the bottom half the difference (experiment minus control) with bars representing the minimum difference required for 95% statistical significance.

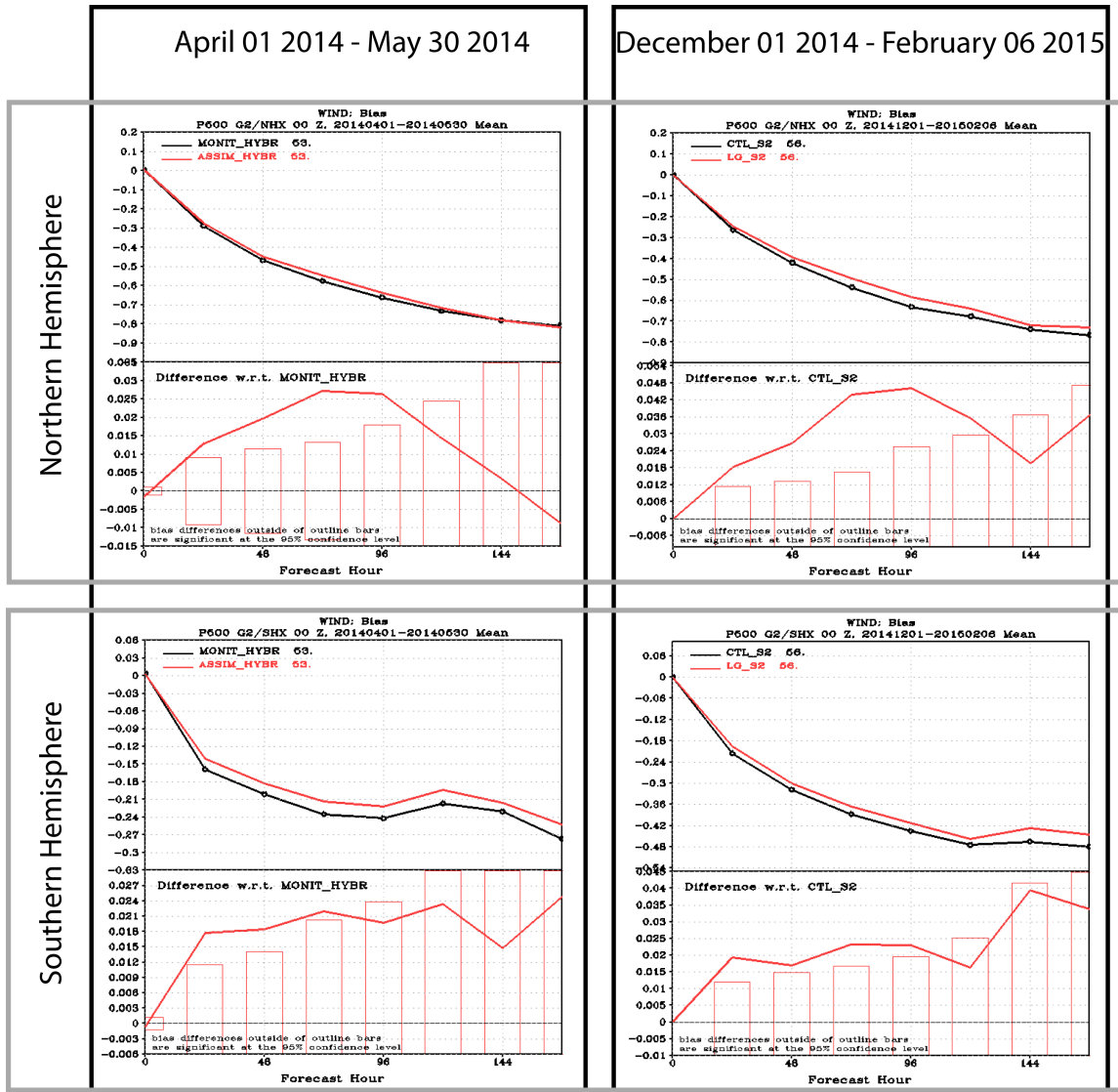

Figure 27. Mean 500 hPa wind speed bias scores for LEO/GEO experiments from (left) 01 April 2014 – 30 May 2014 and (right) 01 December 2014 – 06 February 2015, for the (top) northern hemisphere and (bottom) southern hemisphere. All four panels show in the top half the mean correlation die-off curve for the control in black and the experiment in red, and in the bottom half the difference (experiment minus control) with bars representing the minimum difference required for 95% statistical significance.

## 6.8 Probabilistic Forecasting of Severe Convection through Data Fusion

CIMSS Task Leader: John Cintineo

CIMSS Support Scientist: Justin Sieglaff

NOAA Collaborator: Michael Pavolonis

Budget: \$75,000

### NOAA Long Term Goals:

- Weather-Ready Nation

### NOAA Strategic Goals:

- Serve society's needs for weather and water





- Support the nation's commerce with information for safe, efficient and environmentally sound transportation
- Provide critical support for the NOAA mission

### **CIMSS Research Themes:**

- Satellite Meteorology Research and Applications
- Satellite Sensors and Techniques

### **Objective**

The NOAA/CIMSS ProbSevere model helps NWS forecasters skillfully increase lead-time to severe convective hazards.

### **Project Overview**

The NOAA/CIMSS ProbSevere model has been developed as a nowcasting probabilistic guidance tool for forecasters to better predict severe convective storm hazards. ProbSevere utilizes a satellite and radar object-based framework to fuse together NWP environmental information, temporal trends in GOES-derived imagery, Multi-Radar Multi-Sensor (MRMS) products, and Earth Networks Total Lightning Network (ENTLN) data as inputs into a statistical model that calculates the probability of any given storm will produce severe weather in the next 60 minutes.

### **Milestones with Summary of Accomplishments and Findings**

- *Optimize empirical model for increased temporal resolution spectral data, by making the satellite growth rate predictors a function of elapsed time between scans. Investigate impact of growth rates using super-rapid scan satellite imagery.*  
We have made the satellite growth predictors in ProbSevere a function of time between scans, with different lookup tables for routine operation and rapid scan operation. This has resulted in fewer false alarms. We have begun investigating the effect of super-rapid scan GOES data on ProbSevere using GOES-14 experimental data while in super-rapid scan mode.
- *Switch from using RAP to using HRRR and/or SPC-OA for near-storm environment data. Test other near-storm environment predictors that can be derived from high-resolution NWP data, and incorporate the most skillful NWP predictors.*  
We have investigated producing derived NWP products from the HRRR model as opposed to the RAP. We have noted that for the current NWP products used in ProbSevere, it is feasible to create them in a timely manner using the HRRR. However, production of future derived products may be computationally expensive when using the HRRR in our current framework (optimization in C or Fortran may help). Thus, we have opted to stick with the RAP model for now.
- *Examine total lightning data for storms in reliable LMA coverage. Determine the best total lightning product(s) and incorporate them into the empirical model as predictors.*  
Total lightning data from ENTLN has been deemed a more advantageous test product than LMA data for ProbSevere, given their superior coverage and current availability to NOAA. Using a large training set from spring and summer of 2014, total lightning information has been incorporated into ProbSevere, in the form of a 2D lookup table coupled with effective bulk shear. This configuration has been shown to increase lead-time and skill slightly to the first local storm report and increase skill markedly to all/each latter report, relative to the 2015 real-time configuration of ProbSevere.
- *Compare the identification and tracking of storms using total lightning density to using radar imagery, and evaluate the utility of total lightning tracking.*



Identification and tracking on total lightning flash density was investigated. We have opted to maintain radar and satellite tracking only, on account of more frequent object ID changes in the spatially less coherent lightning objects, which may cause problems if temporal aspects of total lightning are used (e.g., lightning jump algorithm).

- *Create an AWIPS II product that is easy to interrogate and can be displayed over other data.*

An AWIPS-II plug-in has been developed and updated for inclusion of total lightning information.

- *Conduct real-time experiments at the Hazardous Weather Testbed (HWT) and local WFOs. Use feedback to improve the empirical model and display. Conduct off-line evaluation of empirical model to generate robust statistics of performance, and identify limitations.*

Plans are moving forward to test ProbSevere in spring 2016 at the Hazardous Weather Testbed and select NWS central and eastern region WFOs. An internal evaluation of ProbSevere has also been performed, showing improved skill relative to 2015 model configuration.

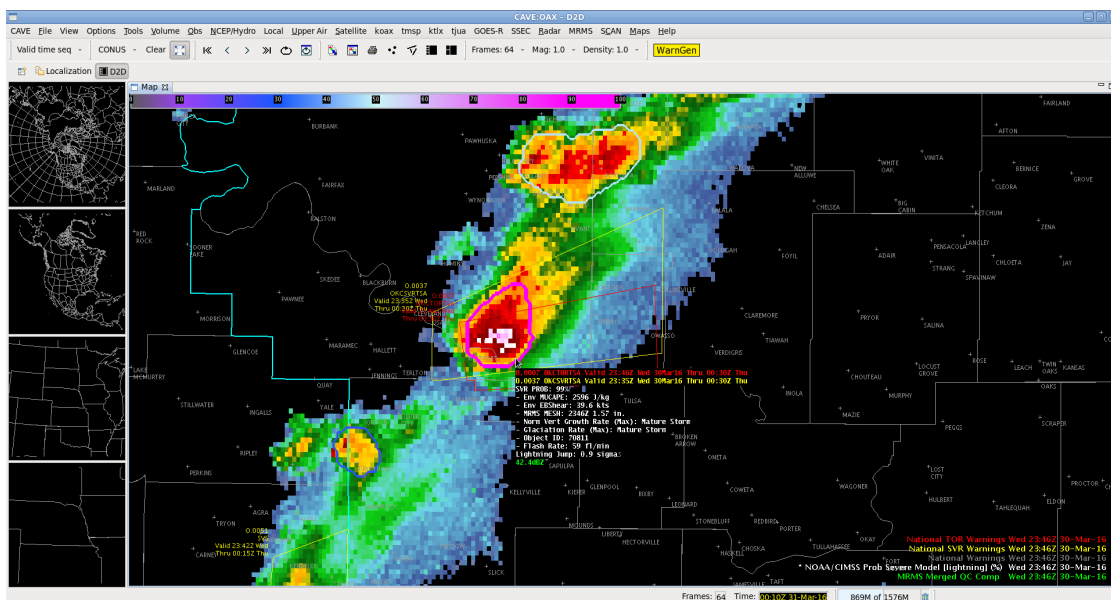

Figure 28. This storm in northeast Oklahoma (March 30, 2016) produced large hail and several EF-2 tornadoes. The predictors in the ProbSevere model combined to assign a probability of 95% well before the first severe thunderstorm warning was issued (see <http://www.goesrhwf.blogspot.com/2016/03/tulsa-claremore-ok-tornado.html>).

## Publications and Conference Reports

Pavlonis, M. J., J. L. Cintineo, and J. M. Sieglaff, 2016: The NOAA/CIMSS ProbSevere Model – Integration of NWP, Satellite, Lightning, and Radar data for Improved Severe Weather Warnings. 12th Annual Symposium on New Generation Operational Environmental Satellite Systems, New Orleans, LA, 8.2

## References

Cintineo, J. L., M. J. Pavlonis, J. M. Sieglaff, and D.T. Lindsey, 2014: An empirical model for assessing the severe weather potential of developing convection. *Weather and Forecasting.*, 29, 639-653.



Cintineo, J. L., M. J. Pavolonis, J. M. Sieglaff, and A. K. Heidinger, 2013: Evolution of severe and non-severe convection inferred from GOES-derived cloud properties. *J. Appl. Meteorol. Climatol.*, 52, 2009-2023.

Lakshmanan, V., T. Smith, G. Stumpf, and K. Hondl, 2007: The Warning Decision Support System-Integrated Information. *Weather and Forecasting*, 22, doi:10.1175/WAF1009.1

Pavolonis, M. J., 2010: Advances in Extracting Cloud Composition Information from Spaceborne Infrared Radiances-A Robust Alternative to Brightness Temperatures. Part I: Theory. *Journal of Applied Meteorology and Climatology*, 49, doi:10.1175/2010JAMC2433.1.

Sieglaff, Justin M., D. C. Hartung, W. F. Feltz, L. M. Cronic, V. Lakshmanan, 2013: A satellite-based convective cloud object tracking and multipurpose data fusion tool with application to developing convection. *J. Atmos. Oceanic Technol.*, 30, 510–525.

### **6.9a Development and Demonstration of a Coupled GOES-R Legacy Sounding NearCast with Convective Initiation Products to Improve Convective Weather Nowcasts**

**CIMSS Task Leader: Lee Cronic**

**CIMSS Support Scientist: Ralph Petersen**

**Budget: Year 1 - \$62K, Year 2 - \$74K**

#### **NOAA Long Term Goals:**

- Weather-Ready Nation

#### **NOAA Strategic Goals:**

- Provide critical support for the NOAA mission

#### **CIMSS Research Themes:**

- Satellite Meteorology Research and Applications
- Satellite Sensors and Techniques
- Environmental Models and Data Assimilation

#### **Objective**

The objective is to provide a more refined convective initiation (CI) nowcast by incorporating additional environmental information provided by GOES to identify where convection is most likely to form through the fusion of two established convective monitoring GOES-R algorithms.

#### **Project Overview**

This objective will be accomplished by reducing over-forecasting and improving under-forecasting of the current 0-1 h GOES-R CI algorithm via integration of 0-3 h NearCasts of GOES-R Legacy Sounding Moisture, Temperature and Stability products within GOES-R CI as a means of better defining areas in which convective clouds are most/least likely to develop into strong convective storms. This approach will maximize the use of all the forthcoming GOES-R Advanced Baseline Imager capabilities: Visible imaging, infrared (IR) imaging, high time-resolution (1-5 min) imagery, as well as the 15-30 min interval clear-air profiles (especially moisture). CIMSS extent of responsibility for this project concerns any modification or support of the GOES-R Legacy Sounding NearCast algorithm.



## Milestones with Summary of Accomplishments and Findings

### ***NearCast Algorithm***

A milestone of the NearCast algorithm for this initial period was to enhance the algorithm in the 0-2 h CI nowcast time range. This was done by spatially interpolating additional temperature and moisture variable output to additional standard atmospheric pressure levels. These new data fostered the creation of tendency fields of true and derived atmospheric quantities allowing the deduction of stability trends promoting heightened (lessened) awareness of potentially unstable (stable) environments prior to CI. These new data are also useful in identifying/masking areas of over-forecast CI.

### ***Data Fusion***

For this initial period, specific outstanding cases of GOES-R CI were identified so preliminary comparisons of the NearCast model fields and GOES-R CI could be made. These comparisons are necessary to flesh out which combination of fields provide the best support for improved convective nowcasts. This blending of data is initially accomplished through the development of a fused NearCast/CI product display. An example of this new product display is given in Figure 29. Figure 29 illustrates a case where the GOES-R CI algorithm over-forecast the probability of convective development over northeast New Mexico and northwest Texas. Validating satellite and radar (not shown) show us that strong convection did not form in those areas. If one looks at the NearCast fields, in particular the low-level equivalent potential temperature tendency, the NearCast shows cooling and/or drying taking place, implying stabilization of the environment. Since these NearCasts are made two hours prior to CI valid time, the NearCasts can be incorporated into the logistical regression framework of the CI algorithm and filter/suppress the CI probabilities in this particular example.

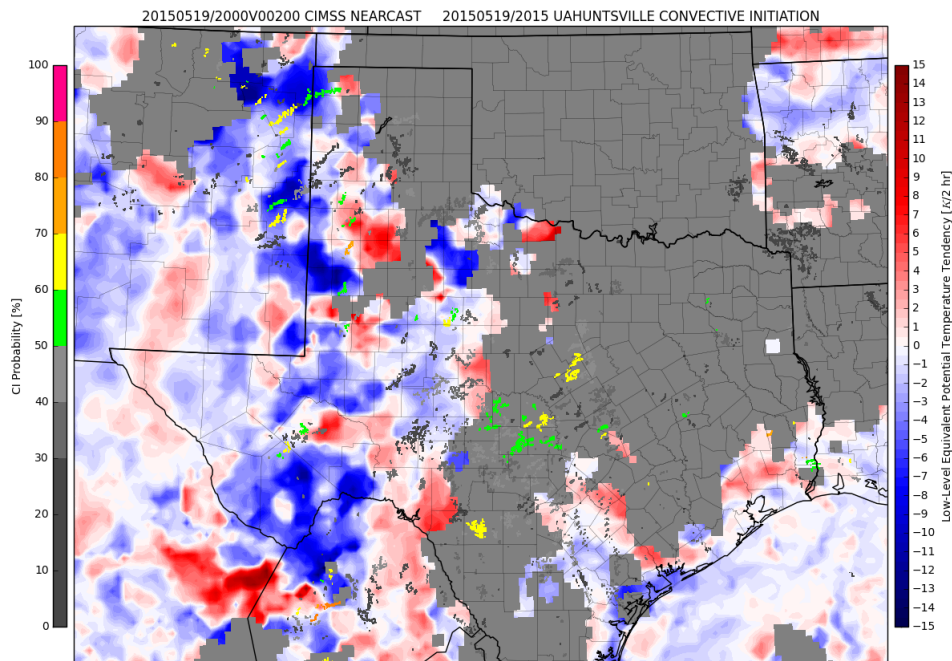

**Figure 29. Fused GOES-R Legacy Sounding NearCast and Convective Initiation Product display showing NearCast 2 h forecast of low-level equivalent potential temperature tendency valid at 2000 UTC 19 May 2015 with overlaid CI nowcasts valid at 2015 UTC 19 May 2015.**



## **Publications and Conference Reports**

Mecikalski, J., L. Cronce, R. A. Petersen and C. Jewett, 2015: Development and Demonstration of a Coupled GOES-R Legacy Sounding NearCast with Convective Initiation Products to Improve Convective Weather Nowcasts. European Severe Storms Conference, Wiener Neustadt, Austria.

Petersen, R. A., L. Cronce, W. Line and R. Aune, 2015: Exploring New Forecaster Applications and Data Sources for NearCasts as a Prelude to MTG-IRS. EUMETSAT Users Conference, Toulouse, France.

## **6.9b Preparing the CIMSS NearCast system for Transition from Research to Operations (R2O)**

**CIMSS Project Lead: Ralph A. Petersen**

**NOAA Collaborators: Robert Aune, Steve Goodman**

**Budget: \$50K/year for 2 years**

### **NOAA Long-Term Goals Supported**

- Weather-Ready Nation

### **CIMSS Research Themes**

- Satellite Meteorology Research and Applications
- Environmental Models and Data Assimilation

### **CIMSS Research Themes**

- Satellite Meteorology Research and Applications
- Environmental Models and Data Assimilation

## **Objective**

This project is an augmentation in support of the CIMSS Project 6.9a: Development and Demonstration of the Fusion of GOES-R Legacy Sounding NearCasts with Convective Initiation Products to Improve Convective Weather Nowcasts. The overall objective is to provide data driven tools to help NWS forecasters expand their use of GOES clear-sky moisture and temperature soundings by enhancing and expanding existing observations and providing feedback to NOAA through the use of products from current and future GOES satellites. In particular, this effort will assure that NearCast fields will be available in the future both to directly support real-time forecasting and also to enhance other GOES-R products, most notably by reducing the false-alarms present in GOES-R Convective Initiation (CI) products.

## **Project Overview**

This project has several primary tasks: 1) to restructure and simplify the NearCast system to make it meet standards for use in NOAA operations and to reformulate the system in sigma coordinates to better accommodate areas of extreme terrain, 2) to provide NearCast products in real time to NWS users and collaborative researchers ([.g., University of Alabama-Huntsville (UAH)] and to perform assessments and validations of the NearCasting related products, and, to a smaller degree, 3) to participate with WMO-related programs in obtaining funding for Nowcasting improvement being developed for Weather Services in the Lake Victoria Basin (hereafter LVB). Although the NearCast system has proved extremely useful at projecting conservative parameters forward in both time and space, the configuration of the system remains closely tied to its original



‘research development’ environment and thereby needs to be transitioned to use more operationally appropriate structures before becoming fully operational. Specific tasks include:

Task 1. The NearCasting model will be generalized to run over any portion of the globe and to include a sigma-based (terrain following) vertical coordinate, a critical factor for application over the high elevation and steeply sloped terrain. The inclusion of a sigma-coordinate option will both allow better use of GOES-R soundings in areas of higher surface elevation and provide additional information to forecasters about possible orographic triggering mechanisms. The objective of this effort is to facilitate integration of the NearCast model with the other GOES-R products by establishing a ‘generalized and operationally maintainable’ version of the NearCast model code and script structures. The possible inclusion of the generalized NearCast model as a future forecaster application using SEVIRI retrievals over LVB (see point 3 later) will also improve the use of GOES-R sounding products in tropical environments in the Americas.

Task 2. Output from the generalized NearCast system will then be made available for integration by other GOES-R researchers for integration with their GOES-R algorithm. CIMSS would make scientific and computing support available for generating the NearCast products, as well as continue to run the original CIMSS version of the system as a comparison benchmark for a period of time.

Task 3. Work with the WMO to acquire funding to provide NearCasts in the LVB that could provide forecasters with better and more temporally-consistent, real-time products than can be provided by SEVIRI observations alone and to provide a possible methodology for using higher time/space resolution SEVIRI products to monitor NWP performance in areas with minimal radar coverage. CIMSS personnel will also provide case study material, participate in WMO Nowcast training exercises in the LVB as needed, as well as participate in broader WMO Nowcasting proposal development in coordination with the GOES-R project, NSF, EUMETSAT and WMO

### **Milestones with Summary of Accomplishments and Findings**

It should be noted that funding for this project did not arrive until late in FY2015. Since then, the NearCast generalization described in Tasks 1 and 2 has focused primarily on system design and coding standards issues. Effort on Task 3 has focused on preparing for and participating in the WMO Severe Weather Forecast Improvement Workshop held in Addis Ababa, Ethiopia in November 2015, as well as proposal development and review.

#### ***Task 1 - NearCasting System Generalization***

This task is in the final design phases. An initial plan for simplifying the system software and removing non-operational-standard components has been developed. The expertise of William Line, who developed the isentropic version of the NearCast model, has also been assured at no additional cost to the project, which should facilitate the incorporation of the sigma-coordinate option. All codes will rely on standard NCEP W-3 routines rather than specialized CIMSS routines, with internal coding using the latest versions of Fortran, thereby allowing dynamic array sizing and other software efficiencies.

#### ***Task 2 – Model Export Preparation***

Task is scheduled to begin after completion of task 1.

#### ***Task 3 – Lake Victoria Basic Nowcast Project Preparation***

The NearCast model is being run in real time for the LVB using data generated by the CSPP based on radiances received from EUMETSAT. LVB specific web pages have been developed



and data are also available in GRIB-II format. Effort focused on preparing for and participating in the WMO Severe Weather Forecast Improvement Workshop held in Addis Ababa Ethiopia in November 2015.

### **Year 2 Milestones**

Q1: Prepare tests to evaluate generalized NearCasting Model and prepare for real-time use

Q2: Begin testing of generalized NearCasting Model

Q3: Updates of training materials provide to GOES\_R Liaisons

Q4: Transfer generalized system for real-time operation at designated site

- Prepare report and publish findings

Full Year: Coordinate with WMO LVB in Nowcasting proposal

## **6.10 Transitioning the NASA Aircraft Icing Threat Capability to NOAA Operations**

**CIMSS Task Leader: Andi Walther**

**NOAA Collaborator: Andrew Heidinger**

**Budget: \$24,000**

### **NOAA Long Term Goals:**

- Climate Adaptation and Mitigation
- Weather-Ready Nation

### **NOAA Strategic Goals:**

- Serve society's needs for weather and water
- Understand climate variability and change to enhance society's ability to plan and respond
- Provide critical support for the NOAA mission

### **CIMSS Research Themes:**

- Satellite Meteorology Research and Applications
- Satellite Sensors and Techniques

### **Objective**

This project supports transition of the NASA Aircraft icing threat capability to NOAA operations.

### **Project Overview**

Aircraft icing is a major hazard to aviation and no phase of aircraft operations is immune to the threat. This proposal addresses a high National Weather Service (NWS) priority to improve the diagnosis of dangerous aircraft icing conditions for the aviation community. A capability to determine the in-flight icing (IFI) threat to aircraft has been developed that uses satellite derived cloud parameters. The methods are applicable to cloud parameters now commonly retrieved in real-time from meteorological satellite data, and are particularly well suited for application to the high spatial and temporal resolution operational cloud products from the GOES-R ABI.

Verification studies indicate that relative to traditional icing forecasting techniques based on NWP analyses, the satellite methods significantly improve the resolution of icing conditions, including the dangerous conditions found to be associated with several recent aviation incidents and accidents. The objectives of this proposal are to (1) integrate a state of the art satellite based icing algorithm into the NOAA GOES-R Proving Ground (PG) processing system at the Cooperative Institute for Meteorological Satellite Studies (CIMSS), (2) validate and tune the algorithm, if necessary, using icing PIREPS as guidance, (3) generate and deliver satellite-based



flight icing threat (S-FIT) products to the major NWS aviation weather forecast offices and to the PG with the current CIMSS product suite, (4) develop training materials for the S-FIT products, and (5) participate in and conduct S-FIT product evaluations to acquire feedback. The expected benefits to the NWS and the aviation community include better definition and situational awareness of the in-flight icing threat, improved icing forecasts, and the potential for safer, more efficient aviation.

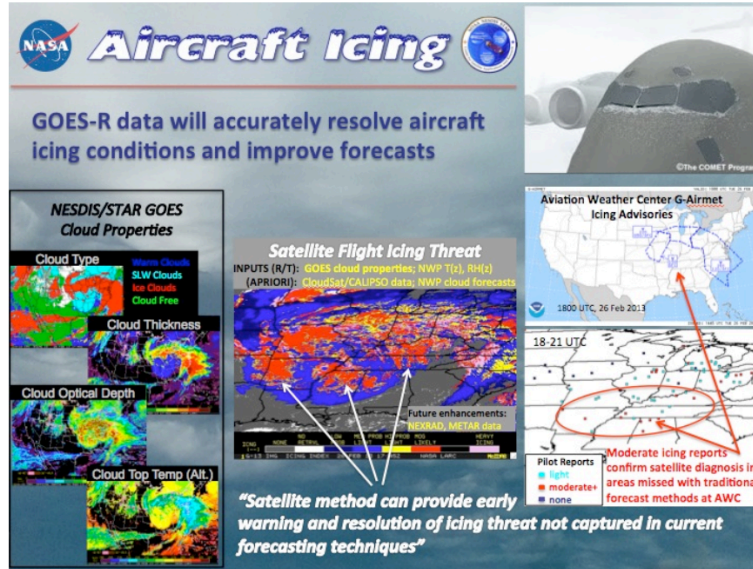

**Milestones with Summary of Accomplishments and Findings**

- We have been generating quasi- operational wintertime proxy GOES-R cloud property dataset from current GOES over the CONUS using the CIMSS Proving Ground data processing facility CLAVR-x.
- Those cloud product data are quality checked with suited statistical and monitor tools and provided to our colleagues at NASA LaRC.
- We also prepared implementation of software modules for GOES-R IFI algorithm (NASA).
- We prepared suited training presentation material.

**7. CIMSS Participation in the Development of GOES-R Proving Ground in 2015-2016**

**CIMSS Task Leader: Wayne Feltz**

**CIMSS Support Scientists: Chris Velden, Sarah Griffin, Scott Bachmeier, Scott Lindstrom, Lee Cronic, Justin Sieglaff, Kaba Bah**

**NOAA Collaborators: Michael Pavolonis (NESDIS/STAR), Bradley Pierce (NESDIS/STAR), Andy Heindinger (NESDIS/STAR), and Tim Schmit (NESDIS/STAR)**

**Budget: \$242,500**

**NOAA Long Term Goals:**

- Weather-Ready Nation





### **NOAA Strategic Goals:**

- Serve society's needs for weather and water
- Support the nation's commerce with information for safe, efficient and environmentally sound transportation

### **CIMSS Research Themes:**

- Satellite Meteorology Research and Applications
- Satellite Sensors and Techniques
- Education and Outreach

### **Objective**

CIMSS researchers will expand partnerships with NWS Forecast Offices and NOAA National Centers to provide these products, train forecasters in their applications, and evaluate their utility. This work will help to ensure that GOES-R products will be available and useful to forecasters soon after launch.

### **Project Overview**

This proposal is for continued support to the NOAA GOES-R Proving Ground that will test and validate satellite-based algorithms and products before they are integrated into operational use. The Proving Ground mission is designed to ensure User Readiness on Day 1 for GOES-R. To this end, we are seeking assistance via the GOES-R Proving Ground in evaluating the GOES-R Algorithm Working Group demonstration algorithms and baseline/future satellite capability decision support products, testing enhancements and advanced products (Risk Reduction), and providing user assessments and feedback to the product developers. CIMSS researchers will expand partnerships with NWS Forecast Offices and NOAA National Centers to provide these products, train forecasters in their applications, and evaluate their utility. This work will help to ensure that GOES-R products will be available and useful to forecasters soon after launch.

### **Milestones with Summary of Accomplishments and Findings**

CIMSS supported the GOES-R Proving Ground demonstrations by evaluating the GOES-R Algorithm Working Group demonstration algorithms and baseline products, testing enhancements and advanced products (Risk Reduction), and providing user assessments and feedback to the product developers. Partnerships were expanded with NWS Forecast Offices in 2015-2016 to help train additional forecasters in product applications and to evaluate their utility. This work helped to ensure that GOES-R products were available and useful to forecasters soon after launch.

In 2015-2016 research period of performance, the primary focus was to test, apply, and improve select GOES-R satellite baseline, future capability, and risk reduction imagery/products in support of National Centers and local NWS offices. CIMSS researchers and scientists attended the June 2015 Proving Ground and User Readiness Satellite Science week in Kansas City, MO to determine goals/milestones of the GOES-R Risk Reduction and Proving Ground tasks and were present at regular by-monthly GOES-R Proving Ground coordination/reporting teleconferences. GOES-R PG oral and poster presentations occurred at various conferences in 2015-2016 including the American Meteorological Society (AMS) Conference, the National Weather Association (NWA) Conference, and the 2014 EUMETSAT Annual conference in Toulouse, France. Internet web site access to GOES-R Proving Ground activities is hosted at: [http://cimss.ssec.wisc.edu/goes\\_r/proving-ground.html](http://cimss.ssec.wisc.edu/goes_r/proving-ground.html).



### **1. Test and apply algorithms for expected GOES-R satellite data imagery/products in support of National NOAA Testbeds/PG Demonstrations**

The following Proving Ground activities occurred in 1 April 2015 – 30 March 2016 funding cycle where several GOE-R proxy decision support products developed at CIMSS were demonstrated with operational forecasters to obtain feedback:

1. Hazardous Weather Testbed (HWT) Spring Experiment (4 May – 12 June, 2015). Participants included 4 CIMSS researchers, 25 NWS forecasters, 5 Broadcast Meteorologists and several visiting scientists.
2. National Hurricane Center (NHC) Tropical Cyclone Demonstration (1 August – 30 November 2015) Participants included forecasters from NHC
3. Aviation Weather Center (AWC) Summer Experiment (10 August – 21 August 2015). Participants included AWC forecasters and FAA representatives.
4. HPC/ OPC/ TAFB/ and SAB demonstrations (ongoing: focus on precipitation and ocean applications).
5. High Latitude and Arctic Testbed (ongoing: focus on snow/ cloud/ volcanic ash/ and aviation applications). Participants include NWS Alaska Region
6. Air Quality (ongoing: focus on aerosol detection).
7. Pacific Region OCONUS Demonstration (ongoing: focus on tropical cyclones/ heavy rainfall/ and aviation applications). Participants include Jordan Gerth, NWS forecasters and scientists from the University of Hawaii.

CIMSS scientists were engaged with the demonstrations listed above by providing the following GOES-R Baseline, Future Capability, or Risk Reduction decision support proxy data. Product assessment highlights for eight of the CIMSS decision support products are listed below as reported in the GOES-R PG 2015 Annual report (to be published) and HWT/AWC/NHC Testbed final evaluation reports located at: <http://www.goes-r.gov/users/proving-ground.html>

#### ***UW-CIMSS Decision Support Product GOES-R Proving Ground Significant Outcomes and Product Assessment Highlights***

CIMSS scientists were engaged with the demonstrations listed above by providing the following GOES-R Baseline, Future Capability, or Risk Reduction decision support proxy data. Product assessment highlights for eight of the UW-CIMSS decision support products are listed below as reported in the GOES-R PG 2014 Annual report (to be published) and HWT/AWC/NHC Testbed final evaluation reports located at: <http://www.goes-r.gov/users/proving-ground.html>

1. UW-CIMSS Decision Support Product GOES-R Proving Ground Significant Outcomes and The Fog and Low Stratus products are currently scheduled to be operationalized on OSPO ESPC systems and will be delivered to NWS users via Satellite Broadcast Network (SBN), NCEP Central Region Operations (NCO) backbone, Direct Broadcast, and possibly AWIPS Data Distribution Service (DDS) as an alternative.
2. The NOAA/CIMSS ProbSevere model was evaluated in the HWT for the second consecutive year, with minor updates made since last year's experiment. The statistical model produces a probability that a developing storm will first produce any severe weather in the next 60 minutes. The data fusion product merges NWP-based instability and shear parameters, satellite vertical growth and glaciation rates, and radar derived maximum expected size of hail (MESH). A developing storm is tracked in both satellite and radar imagery using an object-oriented approach. As the storm matures, the NWP information and satellite growth trends are passed to the overlapping radar objects. The product updates approximately every two minutes and is displayed as contours that change color and thickness with probability to be overlaid on radar imagery. Data readout



- is available by mousing over the probability contour, revealing the probability of severe along with the model predictor values.
3. Simulated Satellite Forecasts are available in AWC and SPC operations (experimental).
  4. The GOES-R convective overshooting top product was transitioned into SPC and AWC operations (experimental) in 2014 and the use of the product has continued to gradually increase,  
GOES-R OT Proxy 2014 SPC Mesoscale Convective Discussions:  
<http://www.spc.noaa.gov/products/md/2014/md1127.html>  
<http://www.spc.noaa.gov/products/md/2014/md0753.html>  
<http://www.spc.noaa.gov/products/md/md0401.html>  
<http://www.spc.noaa.gov/products/md/md0162.html>
  5. SRSO (Super Rapid Scan Operations GOES-14 was activated in May and August 2014, and was made available to SPC and AWC operations for display in N-AWIPS in addition to Fog/Low Stratus and GOES-R Cloud Top Phase proxy. SRSOR This imagery was popular among the forecasters, particularly for the excellent situational awareness it provides via the additional detail in areas of rapid convective development. SSEC/CIMSS archived the data and quicklook loops are available here:  
[http://cimss.ssec.wisc.edu/goes/srsor2014/GOES-14\\_SRSOR.html](http://cimss.ssec.wisc.edu/goes/srsor2014/GOES-14_SRSOR.html)
  6. GOES-R Legacy Atmospheric Profile Products - New to the HWT this year were moisture and stability fields generated via a fusion of GOES Sounder radiance observations and Numerical Weather Prediction (NWP) forecast data using a GOES-R Risk Reduction (GOES-R3) algorithm.

### *NOAA Testbed Specific Feedback*

#### ***WRF Simulated ABI Synthetic Satellite cloud and moisture imagery (Baseline)***

**HWT input:** In general, forecasters found the synthetic satellite imagery to be a useful and unique tool for evaluating a particular model forecast cycle. More specifically, participants speculated the effects that displacements early in the forecast cycle might have on subsequent hours. Forecasters understood that even if feature placement or timing was off, constructive information could still to be gained from the synthetic imagery such as storm character and evolution.

**AWC input:** While the simulated imagery clearly was shown to be a beneficial forecast tool by a vast majority of the desks at the AWC, it is important to recall that the original purpose of the simulated imagery was to familiarize forecasters with the baseline capabilities of the ABI. For this reason AWC forecasters would like to continue to evaluate the simulated imagery, but shift their focus to further explore the potential capabilities of each new band. For example, exploring the benefit of having three water vapor channels in forecasting for various levels of turbulence. Though this concept was explored to some extent this year, forecasters would like more evaluation done to this end during the next demonstration period.

#### ***GOES Imager Super Rapid Scan Operations Imagery (Baseline)***

**HWT input:** The most obvious benefit of the 1-min satellite imagery from GOES-14 to the forecasters was the new ability to observe cloud fields as they evolved in near real-time instead after they had changed. Not only was the forecaster receiving new images more often, but the images were available with decreased latency (3-4 min) compared to current routine imagery. This created substantial lead time to the identification of processes and features that are vital to convective 23 nowcasting. The 1-min imagery aided the warning forecaster across the entire convective cycle, including: environmental analysis pre-CI, identification of CI, mature



convective monitoring, warning issuance, and storm weakening. Additionally, forecasters were creative in utilizing the 1-min imagery in concert with other very high temporal resolution data sources. Participants answered that the 1-min satellite imagery provided them with significant information not captured in the routine satellite imagery on 93% of the days when it was available.

While some forecasters preferred to load shorter, 20-50 frame loops, others found it more useful to load 100+ frames in AWIPS-II. Additionally, most forecasters experienced the greatest benefit from the imagery when it was “hyperlooped”, increasing dwell rates to greater than what the AWIPS-II default menu permits. This allowed for a fluid visualization of atmospheric phenomena. There were no major AWIP-II performance issues noted in association with the 1-min satellite imagery, even as over 100 frames were loaded and various data combinations were used.

Various algorithms are being developed to further take advantage of the 1-min satellite data and complement the imagery, some of which were demonstrated in the HWT. The automated Overshooting Top (OT) Detection algorithm is one such product that was generated from the 1-min data and made available to the HWT participants in AWIPS-II. Forecasters felt that the algorithm made it easier to identify and track strong, persistent updrafts, and identify cells that were showing weakening trends via collapsing storm tops. With the 1-min imagery, these trends were easier to monitor and significant changes were not missed as is often the case in routine imagery. Many commented, however, that overshooting tops were especially easy to identify 28 manually in the 1-min visible imagery and were often apparent prior to the algorithm picking it up. This is due to the fact that the current algorithm has set brightness temperature thresholds, so weaker overshoots are missed.

**AWC input:** After several hours, the consensus of both AWC and CWSU forecasters was that there really wasn’t a noticeable benefit to having the 1-minute over the 5-minute imagery. By in large, the majority of aviation products are issued on a broad scale, even for the CWSUs. Additionally, with such large areas of responsibility the details of 1-minute imagery are lost in the rapid pace of issuing products. For these reasons, 5-minute imagery would likely suffice.

Perhaps the only part of aviation operations that isn’t always broad scale is in terminal traffic flow. While the NAMs are monitoring all terminals, if there is weather around a specific terminal causing variations in mesoscale flow, they will take a closer look. Changing mesoscale flow patterns can cause a change of operations (i.e. runways) at a terminal and in some cases, compression issues (i.e. stronger winds above with lighter winds below, causing traffic compression on arrival). Though it hasn’t been explored in detail, 1-minute imagery may be useful in these situations. More information and SRSOR can be found at [http://cimss.ssec.wisc.edu/goes/srsor2014/GOES-14\\_SRSOR.html](http://cimss.ssec.wisc.edu/goes/srsor2014/GOES-14_SRSOR.html)

#### ***Fog and Low Stratus detection (Future Capability)***

**AWC input:** Forecasters would like to keep this product in operations and also focus more on LIFR probabilities. Additionally, it is possible that an Aviation Weather Statement for C&V will be developed. During the Summer Experiment this was explored and the FLS was found to be a valuable tool here as well. It was requested that evaluation to this end be continued in future experiments.



Furthermore, forecasters would like to look more closely at a comparison of the MVFR, IFR, and LIFR probabilities to observed flight conditions, ceilings and visibilities. To this end, a qualitative view of the product has been designed as a web tool. Twenty of the major terminals that deal with ceiling issues on a regular basis have been input into the tool, with analysis of the past 24-hours available at 3-hour intervals.

### ***Legacy Temperature and Moisture Profile - Nearcast Atmospheric Stability Indices (Risk Reduction)***

**HWT input:** The enhanced NearCast analyses and short-range forecasts were the primary ways that forecasters used the GOES Moisture and Temperature soundings in their forecasting process. Without the NearCasts, forecasters would have been unlikely to use the GOES retrievals as stand-alone observations. The NearCast products were especially effective in increasing situational awareness to where convection was more and less likely to initiate in the 0-6 hour range and how on-going convection was likely to evolve. The training was certainly an important part of this success, as it focused on what features to look for in the NearCast fields via multiple examples. The theta-e difference instability field was very well-received by the forecasters, garnering an average rating of 4.41 out of 5 from participants when asked how useful its addition would be to their forecast office. Finally, although the data gaps were undesirable, participants understood why they occurred and didn't let that deter them from using the NearCast products due to the valuable and unique information they provide in areas where GOES data have recently been available.

**AWC input:** The CWSU forecasters were particularly pleased with this product. While they noted that the concept of the NearCast required a bit of a learning curve, they liked the fact that the color bar made it very easy to interpret, in this case the dry air associated with the trough sinking into the middle of the country as compared to the higher instabilities associated with the obvious frontal features of the low. All of the CWSU offices in attendance requested the weblink for the imagery as it is not currently available in their AWIPS

### ***Probability of Severe Model***

**HWT input:** All forecasters recognized the ProbSevere Model as a very useful situational awareness tool, providing them with a quick and easy means of identifying and tracking developing and 16 strengthening storms. This was especially true during busy warning situations when there were many storms that needed to be monitored for the potential to produce severe weather. A high ProbSevere probability value would lead a forecaster to interrogate a storm in more detail, while a low value indicated occurrence of severe was not imminent allowing attention to be focused elsewhere, thus saving the forecaster valuable time. Additionally, rapidly increasing probabilities alerted forecasters to the storm and prompted further interrogation. When operations began after convection had developed, ProbSevere was often the first tool forecasters looked at as it provided them with a quick overview of where the strongest storms were located and where experimental warnings might be necessary. While most forecasters overlaid the ProbSevere data on radar imagery, some preferred to instead load it with satellite imagery in their situational awareness display.

In most cases, forecasters did not issue warnings based solely off of ProbSevere. Instead, significant values or trends would lead a forecaster to interrogate the storm further, using ProbSevere as a supplement to their decision and confirmation for what other data sources were implying. Oftentimes, it would sway the warning decision when the forecaster was still on the fence after appropriate examination. On 95% of days, forecasters answered that the ProbSevere model output helped to increase their confidence in issuing (or not issuing) severe thunderstorm



or tornado warnings. For most, it was important to see at least a couple scans of sustained high probabilities for greatest confidence. Importantly, there were many situations where ProbSevere led to quicker warnings, with forecasters answering that the output helped increase lead time to severe thunderstorm and tornado warning issuance on 76% of days. They noticed that lead time was most apparent when the satellite fields were available, and when the satellite was in rapid scan mode. By the final day of each week, all 25 NWS participants answered that they would use the ProbSevere model output if available during warning operations at their WFO.

*Limitations of ProbSevere:* Forecasters found ProbSevere to be more useful in some situations than others. Similar to last year, they noted that the ProbSevere Model provided the greatest benefit for deep, discrete storms and when hail was the main threat, while probabilities were underdone with low-topped convection when severe wind was the main threat. Forecasters would like to see the ProbSevere model better handle upscale growth into line segments and multicellular systems. In such situations, storm cores were often lumped together into one larger object, causing the data to become less useful. On obvious days when the severe threat was considerable and storm development was most rapid, participants saw ProbSevere more as a confidence booster. In such situations, warnings were often necessitated based on radar data before or as the ProbSevere probabilities increased to over 80%. Forecasters quickly learned this and subsequently began the warning process after the first signs of rapid probability increase and significant growth in the satellite predictors. The increased temporal resolution of the GOES-R ABI (5-min vs. 15-min over CONUS) is expected to help increase lead time when storm development is most intense. Forecasters did find that ProbSevere provided more of an impact on days where the severe threat was more uncertain and when there were many storms to monitor.

### ***Icing***

**AWC Input:** In general, the FIT has been used a situational awareness tool for the issuance of icing AIRMETS, providing forecasters an at-a-glance overview of cloud layers that may contain moderate or greater icing. However, as the icing intensity is only available during the day, forecasters found little use of the product at night, when only a ‘yes/no’ mask is available. Furthermore, the current inputs only allow for icing intensity solutions to be available given that there are no higher ice clouds obscuring the lower layers. In the case of larger scale synoptic systems, where large areas of high ice clouds often do exist, the product is also found to be of little use.

During the 2015 evaluation, NASA LaRC added additional inputs to a very similar algorithm, which dramatically increased the solutions in the presence of higher clouds. Additionally, it allowed the estimation of the base and top of the icing layer. AWC forecasters viewed this algorithm and noted that the addition of those inputs to the GOES-R FIT made the product much more useful. They believe that if these inputs could be combined with the GOES-R DCOMP version of the algorithm (perhaps in a collaborative effort between CIMSS and LaRC), it would provide a much more robust and useable version of the FIT.

### ***Legacy Atmospheric Profiling Products - (Baseline)***

**HWT Input:** The GOES Sounder LAP products were viewed most often by forecasters at the beginning of the shift as they conducted their initial environmental analysis. Additionally, some forecasters viewed the products throughout the shift to get an update on how moisture and instability were evolving. Oftentimes they would use the LAP information as a check on the models and other environmental information (SPC meso-analysis, NUCAPS, etc). Participants liked the full-CONUS coverage of these environmental fields. Past product demonstrations have revealed that a portion of forecasters prefer fields with little-to-no data



gaps, even if that means filling in the gaps with NWP data. In addition to the complete spatial coverage, the hourly availability and low-latency of the LAP products were appreciated, keeping forecasters aware of significant environmental trends as they occurred.

Participants consistently commented that gradients, maxima/minima, and trends in the LAP fields provided them with the most unique and accurate information, rather than the absolute values themselves. It was along the moisture/instability gradients and within the areas of increasing moisture/instability that convection most often developed. Alternatively, decreasing moisture/instability trends were often a sign that convective activity would cease. Forecasters would look back at the fields at the end of the day and see that convection had indeed developed along the gradients and in areas of increasing moisture/instability. Observing this early in the week gave forecasters confidence when using the tools as the week progressed. Additional forecast situations in which the LAP products aided participants included: dryline progression, depth of moisture in the atmosphere, progression of moisture return, elevated or surface-based storms, severe vs. non-severe storms, and convection in data sparse regions.

While the PW values appeared to be reasonably consistent with that from other data sources (e.g., Rapid Refresh Model, SPC meso-analysis, radiosondes), the LAP CAPE absolute values were often substantially different. This led participants to lose trust in the absolute values of the LAP CAPE field, which is the instability field of choice for most operational forecasters. The other major issue with the LAP products was the apparent “blotchiness” and unrealistic spatial variations that oftentimes appeared in the fields. This anomaly was addressed and mostly resolved by the developers after week 3, but deficiencies in the Sounder instrument cause some striping to remain.

## **2. Development of new GOES-R Weather Event Simulations and AWIPS-II transition support**

CIMSS remains committed to assuring a smooth transition of all CIMSS research to operations products from the existing AWIPS software to the upcoming AWIPS-II. Preliminary work has been done finding a new product implementation approach for AWIPS-II. AWIPS-II activities are rapidly accelerating on the national scale to transition local applications between the two software environments. An AWIPS archive capable of archiving 60 days worth of AWIPS formatted files has been acquired through SSEC funding to support easier generation of WES cases AWIPS-II will soon be accessible for use at CIMSS, with training modules employing the new AWIPS software included as part of the VISIT/COMET training programs for operational satellite meteorology professional development. CIMSS participated in multiple GOES-R Proving Ground organizational and testbed/PG demonstration planning telecons. SSEC conducted infrared/microwave/lightning remote sensing “bootcamp” in July 2013 for GOES-R satellite liaison team which was one-week immersion training.

### **Publications**

Bedka, Kristopher M.; Wang, Cecilia; Rogers, Ryan; Carey, Lawrence D.; Feltz, Wayne and Kanak, Jan. Examining deep convective cloud evolution using total lightning, WSR-88D, and GOES-14 super rapid scan datasets. *Weather and Forecasting*, Volume: 30, Issue: 3, 2015, pp.571-590. Reprint # 7396.

Folmer, Michael J.; DeMaria, Mark; Ferraro, Ralph; Beven, John; Brennan, Michael; Daniels, Jaime; Kuligowski, Robert; Meng, Huan; Rudlosky, Scott; Zhao, Limin; Knaff, John; Kusselson,



Sheldon; Miller, Steven D.; Schmit, Timothy J.; Velden, Chris and Zavodsky, Bard. Satellite tools to monitor and predict Hurricane Sandy (2012): Current and emerging products. Atmospheric Research, Volume: 166, 2015, pp.165-181. Reprint # 7433.

Gravelle, Chad, John R. Mecikalski, William E. Line, Kristopher M. Bedka, Ralph A. Petersen, Justin M. Sieglaff, Geoffrey T. Stano, Steven J. Goodman. Demonstration of a GOES-R Satellite Convective Toolkit to “Bridge the Gap” Between Severe Weather Watches and Warnings: An Example from the 20 May 2013 Moore, OK Tornado Outbreak, Bulletin of the American Meteorological Society, Accepted for publication 2015.

Lee, Yong-Keun; Li, Zhenglong; Li, Jun and Schmit, Timothy J.. Evaluation of the GOES-R ABI LAP retrieval algorithm using the GOES-13 sounder. Journal of Atmospheric and Oceanic Technology, Volume: 31, Issue: 1, 2014, pp.3-19. Reprint #7149.

Lee, Yong-Keun; Otkin, Jason A. and Greenwald, Thomas J.. Evaluating the accuracy of a high-resolution model simulation through comparison with MODIS observations. Journal of Applied Meteorology and Climatology, Volume: 53, Issue: 4, 2014, pp.1046-1058. Reprint # 7177.

Monette, Sarah A., Justin M. Sieglaff, 2014: Probability of Convectively Induced Turbulence Associated with Geostationary Satellite–Inferred Cloud-Top Cooling. J. Appl. Meteor. Climatol., 53, 429–436. doi: <http://dx.doi.org/10.1175/JAMC-D-13-0174.1>

Schmit, Timothy J.; Goodman, Steven J.; Gunshor, Mathew M.; Sieglaff, Justin; Heidinger, Andrew K.; Bachmeier, A. Scott; Linstrom, Scott S.; Terborg, Amanda; Feltz, Joleen; Bah, Kaba; Rudlosky, Scott; Lindsey, Daniel T.; Rabin, Robert M. and Schmidt, Christopher C.. Rapid refresh information of significant events: Preparing users for the next generation of geostationary operational satellites. Bulletin of the American Meteorological Society, Volume: 96, Issue: 4, 2015, pp.561-576, supplement. Reprint # 7393.

Sieglaff, Justin M., Lee M. Counce, Wayne F. Feltz, 2014: Improving Satellite-Based Convective Cloud Growth Monitoring with Visible Optical Depth Retrievals. J. Appl. Meteor. Climatol., 53, 506–520. doi: <http://dx.doi.org/10.1175/JAMC-D-13-0139.1>

## **8. CIMSS High Impact Weather Studies with GOES-R and Advanced IR Sounder Measurements**

**CIMSS Task Leader: Jun Li**

**NOAA Collaborator: Timothy J. Schmit (STAR/NESDIS), John L. (Jack) Beven (NHC/NWS), Vijay Tallapragada, (EMC/NWS), Mark DeMaria (NHC/NWS), and Andrew Collard (EMC/NWS)**

**Budget: \$175,000**

### **NOAA Long Term Goals:**

- Climate Adaptation and Mitigation
- Weather-Ready Nation

### **NOAA Strategic Goals:**

- Serve society’s needs for weather and water
- Understand climate variability and change to enhance society’s ability to plan and respond





- Provide critical support for the NOAA mission

#### **CIMSS Research Themes:**

- Satellite Meteorology Research and Applications
- Environmental Models and Data Assimilation

#### **Objective**

The objectives of this CIMSS high impact weather (HIW) studies are to improve the high impact weather (HIW) forecasts with high temporal and spatial resolution GOES-R series water vapor measurements, and to study value-added advanced IR sounder measurements from polar-orbiting satellites for HIW warning, nowcasting and short-range forecasting.

#### **Project Overview**

The first objective of this CIMSS high impact weather (HIW) studies is to improve the high impact weather (HIW) forecasts with high temporal and spatial resolution GOES-R series water vapor measurements. High temporal resolution GOES-R ABI (Advanced Baseline Imager), GOES Sounder, SEVIRI (Spinning Enhanced Visible and Infrared Imager), and Advanced Himawari Imager (AHI) moisture measurements are used for HIW short-range forecasting through data assimilation in regional and storm scale numerical weather prediction (NWP) models. The second objective is to study value-added advanced IR sounder measurements from polar-orbiting satellites for HIW warning, nowcasting and short-range forecasting, and to demonstrate the advantage of combined GOES-R ABI and NPP/JPSS sounder measurements in HIW nowcasting and short-range forecasting. AIRS, IASI, CrIS from POES and ABI, GOES Sounder, SEVIRI, AHI from GEO will be used altogether for this purpose (e.g., study the application of atmospheric moisture and instability information from the combined POES/GOES measurements in pre-convection environment for warning and forecasting).

CIMSS HIW project is highly related to reliable and stable forecasts on super storm such as hurricane Sandy (2012) landed on CONUS. Continuous observations of atmospheric moisture information in environment are very important to the prediction of the genesis, intensification, motion, rainfall potential, and landing impacts of storms through NWP models. ABI on GOES-R series will provide water vapor information with much better coverage and higher temporal/spatial resolution than the current GOES. A dedicated research towards operational application of GOES-R water vapor measurements for HIW events is needed to optimize the information extraction, data assimilation and utilizations within a higher resolution regional NWP framework. The advantages of GOES-R data for regional NWP are that (a) the data have good temporal coverage to assure the data availability within each assimilation time window; (b) the assimilation window can be narrowed (i.e.,  $\pm 0.5$  hour) in order to keep consistency between model's atmospheric states and the observations in a rapid changing weather situation; and (c) more frequent assimilation of data (i.e., hourly assimilation instead of 6-hourly assimilation) is possible.

#### **Milestones with Summary of Accomplishments and Findings**

##### ***Studies Conducted to Address GOES-R ABI Moisture Information Assimilation over CONUS and Impact Related Questions using GOES Sounder (Jul 2015 – Jan 2016)***

One of the key information GOES-R ABI will provide is the high temporal and spatial resolution moisture. While there will be no hyperspectral IR sounder on GOES-R to provide more accurate vertical temperature and moisture information, an important benefit to regional NWP model



applications, ABI's high spatiotemporal resolutions make it possible for severe storm nowcasting and short-range forecasting. The spatial resolution of 2 km (IR channels) is not seen by any other satellite measurements, making it ideal for pre-convection moisture observations. The temporal resolutions of 30 seconds (mesoscale)/5 minutes (contiguous United States; CONUS)/15 minutes (full disk) also provide unprecedented measurements that could capture the rapid evolution of convections which is useful for short-term severe storm forecasts. The window channels provide information about boundary and water vapor channels provide information about middle and upper troposphere.

Using CIMSS SDAT as research testbed, the following question related to better assimilation of ABI moisture information is addressed: How to better use GOES-R three water vapor (WV) bands information in regional NWP? What is the impact from assimilating the three-layer moisture information?

The GOES-13 and -15 Sounder three layered PW (LPW) retrievals using GOES-R legacy atmospheric profile (LAP) algorithm developed by GOES-R sounding team are used as proxy of ABI for this study. The model resolution is 4 km for this study. The model and assimilation configurations are indicated in the left panels of Figure 30, while the case domain and storm evolution from radar is outlined in the right panels of Figure 30.

### TPW/LPW assimilation experiments with CIMSS SDAT as research testbed

**SDAT** – Satellite Data Assimilation for Tropical storm  
(<http://cimss.ssec.wisc.edu/sdat>)

**WRF-ARW**v3.6.1: 4 km horizontal resolution  
(850\*430), 51 vertical layers from surface to 10 hPa

**GSI** v3.1: 3-Dvar Data Assimilation Method

- NAM background error covariance matrix
- The LPW assimilation modules are implemented in GSI system
- Conventional Data – from GTS
- LPW-layer Precipitable Water from GOES-13 and GOES-15 (CIMSS)

**Data**

- Ctrl: GTS
- Exp: GTS + H\_PW (High PW, sig level 0.3 to 0.7)
- GTS + M\_PW (Mid PW, sig level 0.7 to 0.9)
- GTS + L\_PW (Low PW, sig level 0.9 to 1)
- GTS + H\_PW + M\_PW
- GTS + H\_PW + L\_PW
- GTS + M\_PW + L\_PW
- GTS + H\_PW + M\_PW + L\_PW

**Experiments**

Time window: +/- 30 min  
29 06z spin up ---- 29 12z assimilation ---- 24 hr forecasts: **GTS**  
**GTS+LPW**

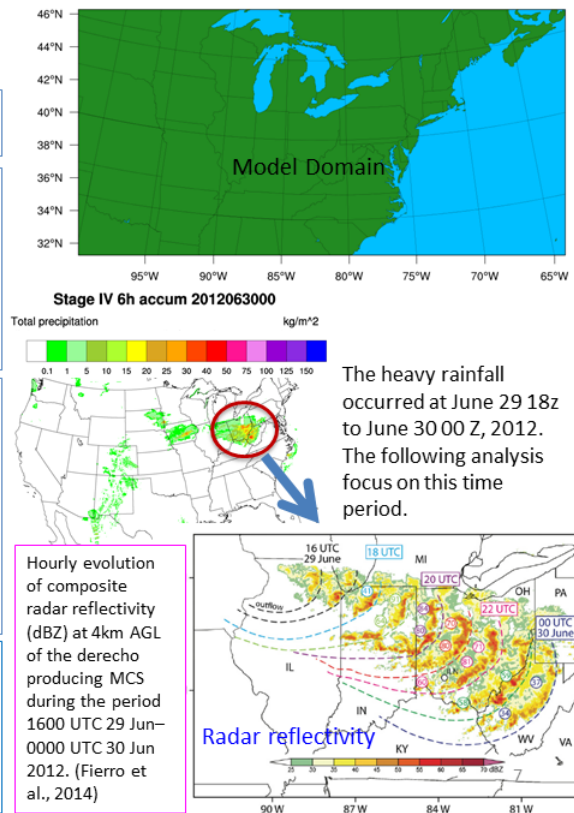

Figure 30. Model and assimilation configurations (left), model domain and storm evolution from radar (right) for a derecho case on 30 June 2012.

The standard ETS (Equitable Threat Score) scores are used to evaluate the 6-hour accumulative precipitation forecasts from assimilation experiments with the following data assimilation:



GTS: global telecommunication system, here means all conventional data used in the assimilation experiments

LPW: layered precipitable water

LPW (H): LPW from 0.3 – 0.7 sigma level

LPW (M): LPW from 0.7 – 0.9 sigma level

LPW (L): LPW from 0.9 – Surface

LPW (HM): LPW (H) + LPW (M)

LPW (ML): LPW (M) + LPW (L)

LPW (HL): LPW (H) + LPW (L)

LPW (HML): LPW (H) + LPW (M) + LPW (L), equivalent to TPW

Eight assimilation and forecast experiments are conducted:

(a) GTS (conventional data) only;

(b) GTS+LPW (H);

(c) GTS+LPW (M);

(d) GTS+LPW (L);

(e) GTS+LPW (HM);

(f) GTS+LPW (ML);

(g) GTS+LPW (HL);

(h) GTS+LPW (HML).

Table 2 summarizes the ETS scores from different assimilation experiments for the rain from 0.1 mm to 10 mm or heavier. Red color means that the ETS score is higher than assimilating GTS conventional data only. It can be seen that the low-LPW gives the higher ETS in the whole period, the mid-LPW gives the lowest ETS in the whole period, and the high-LPW and low-LPW together give the highest ETS scores.

**Table 2. ETS scores from different assimilation experiments for the rain from 0.1 mm to 10 mm or heavier. Time is 2012-6-29 18z to 30 00z.**

ETS scores	0.1 mm	1 mm	5 mm	10 mm
GTS (conv data)	0.5393	0.4978	0.4243	0.2330
GTS+LPW(H)	0.5639	0.5403	0.4447	0.2315
GTS+LPW(M)	0.4881	0.4137	0.3066	0.1770
GTS+LPW(L)	0.5446	0.5093	0.4312	0.2364
GTS+LPW(HM)	0.5578	0.5386	0.4486	0.2412
GTS+LPW(ML)	0.5335	0.4925	0.4274	0.2309
GTS+LPW(HL)	0.5800	0.5644	0.4510	0.2302
GTS+LPW(HML)	0.5434	0.4854	0.4171	0.2958

Assimilation of GOES Sounder data correctly removed false precipitation from control run

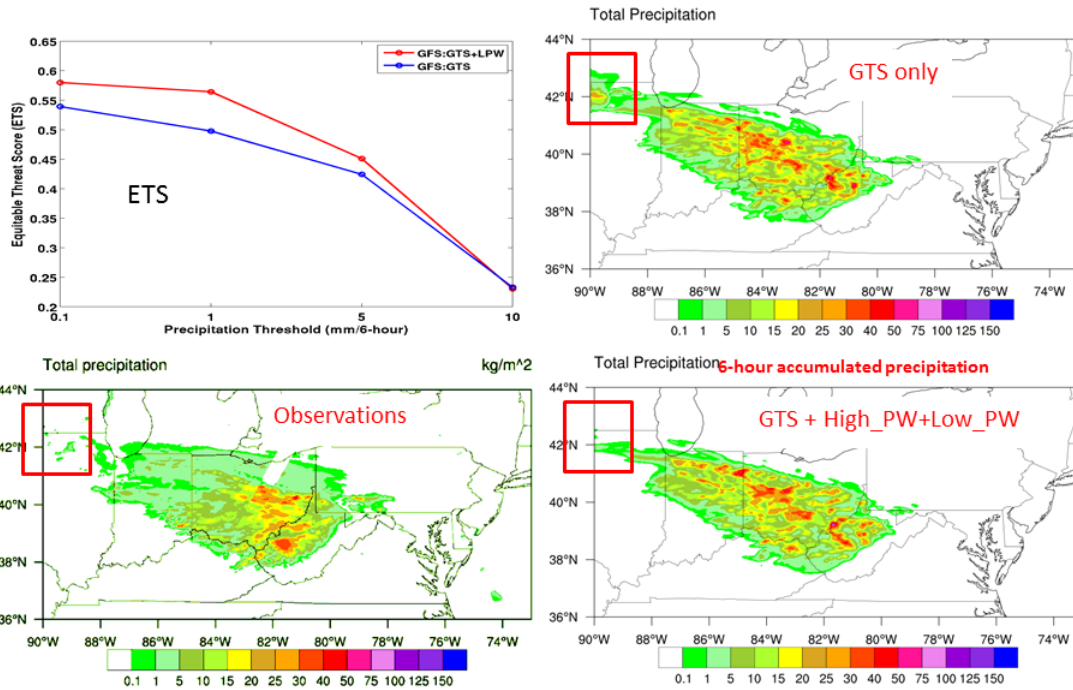

Figure 31. The ETS scores from GTS (blue) and GTS+LPW (PW\_HL) (red) are shown in the upper left panel. The 6-hour cumulative precipitation forecasts from assimilating GTS and GTS+PW\_HL are shown in the right two panels, the observations are shown in the lower left panel.

Figure 31 shows the ETS scores from GTS (blue) and GTS+LPW (PW\_HL) (red) in upper left panel. The 6-hour cumulative precipitation forecasts from assimilating GTS and GTS+PW\_HL are shown in the right two panels, the observations are shown in the lower left panel. It can be seen that assimilation of GOES Sounder LPW data correctly removed false precipitation (see the red box area) from control run and improves the GTS scores. For regional NWP storm forecast, high and lower GOES/GOES-R moisture bands are more important from this study.

**Assimilation of AHI Moisture Information for Tropical Cyclone Forecasts (Feb 2016 – Mar 2016)**

AHI three layered PW (LPW) at sigma level 0.3 – 0.7, 0.7 – 0.9 and 0.9 – SFC are used Typhoon forecast experiments. High resolution WRF (12 km) is used as forecast model and GSI is used as assimilation system. Data are assimilated and 72-h forecasts are updated every 6 hours from 00UTC 03 to 00 UTC 05 August 2015 for Typhoon Soudelor (2015). The following three experiments are conducted: (a) conventional data from GTS (global telecommunication system), (b) GTS+3 LPW, and (c) GTS+AMVs (from Chris Velden).

It is found that (a) compared with assimilating conventional data only, adding AMVs or PW (from 3 layers) improves the analysis fields; (b) Both AMVs and PW improve track forecasts; and (c) LPW improves intensity forecasts after 12 hours, AMVs improves intensity forecasts after 54 hours. The improvements are mainly from slowing the storm down by AHI, the AMVs improve the initial conditions in Typhoon and environment regions, and the LPWs improve the



analysis in the environment region. The ongoing work focuses on combining AMVs and LPW, including LEO sounder data, including vortex relocation step, and more frequent assimilation of AMVs /LPWs.

### **Publications and Conference Reports**

Li, J. et al., 2015: Progress on the assimilation of advanced IR sounder radiances in cloudy skies, The 20th International TOVS Conference (ITSC-20), 28 October – 03 November 2015, Lake Geneva, Wisconsin, U.S.A.

Li, Jun, Jordan Gerth, Timothy J. Schmit, Zhenglong Li, Yong\_Keun Lee, Scott Bachmeier, 2016: Real Time All-weather Precipitable Water Product Development from Geostationary Infrared Radiances and Applications in Weather Forecasts, 96th American Meteorological Society Annual Meeting, New Orleans, LA, 10-14 January 2016.

Li Jun, Pei Wang, Mitch Goldberg, Jinlong Li, Zhenglong Li, Agnes Lim, and Timothy J. Schmit, 2016: On the Assimilation of Advanced Infrared Sounder Radiances in Cloudy Skies, 96th American Meteorological Society Annual Meeting, New Orleans, LA, 10-14 January 2016.

Li, J., et al., 2016: On the assimilation of satellite sounder data in cloudy skies in the numerical weather prediction models, Journal of Meteorological Research (in press).

Wang, Pei, Jun Li, Yong-Keun Lee, Zhenglong Li, Jinlong Li, Zhiquan Liu, Tim Schmit and Steve A. Ackerman, 2016: The Impact of the High Temporal Resolution GOES and GOES-R Moisture Information on Severe Weather Systems in a Regional NWP Model, 96th American Meteorological Society Annual Meeting, New Orleans, LA, 10-14 January 2016.

Wang, P., Jun Li, M. Goldberg, T. J. Schmit, et al., 2015: Assimilation of thermodynamic information from advanced IR sounders under partially cloudy skies for regional NWP, Journal of Geophysical Research - Atmosphere, 120, doi:10.1002/2014JD022976.

Zheng, J., Jun Li, T. J. Schmit, Jinlong Li, and Z. Liu, 2015: The impact of AIRS atmospheric temperature and moisture profiles on hurricane forecasts: Ike (2008) and Irene (2011). Advances in Atmospheric Sciences, 32, 319 - 335.

## **9. Investigations in Support of the GOES-R Program**

### **9.1 Ongoing Support**

**CIMSS Task Leader: W. Paul Menzel**

**NOAA Collaborator: Tim Schmit, Steve Goodman**

**Budget: \$50K**

#### **NOAA Long Term Goals:**

- Climate Adaptation and Mitigation
- Weather-Ready Nation

#### **NOAA Strategic Goals:**

- Serve society's needs for weather and water
- Understand climate variability and change to enhance society's ability to plan and respond



- Provide critical support for the NOAA mission

#### **CIMSS Research Themes:**

- Satellite Meteorology Research and Applications
- Satellite Sensors and Techniques
- Education and Outreach

#### **Objective**

Dr. W. Paul Menzel (WPM), Senior Scientist at the University of Wisconsin-Madison, NOAA Cooperative Institute for Meteorological Satellite Studies (CIMSS), to participate in research on environmental remote sensing systems that helps to guide NOAA in evolving the GOES-R and JPSS satellite holdings

#### **Project Overview**

Project includes (1) facilitating research demonstrations of new capabilities from GOES-R and JPSS, (2) teaching remote sensing seminars to new researchers, (3) participating in the GOES-R Technical Advisory Committee, JPSS Reviews, and other evaluation boards, (4) presenting program plans and research results at appropriate venues, and (5) collaborating with international partners pursuing the same goals.

#### **Milestones with Summary of Accomplishments and Findings**

##### ***Consultation with the Chinese Meteorological Administration (CMA)***

From 14 to 18 October 2015, at a consultative meeting in Beijing with the Chinese Meteorological Administration (CMA), plans for FY-4 were reviewed. Presentations from Mikael Rattenborg, Jim Purdom, Paul Menzel, Lars Peter Riishojgaard, Johannes Schmetz, and Wenjian Zhang covered considerations for spacecraft configuration, imager resolutions, sounder characteristics, NWP impacts, and space constellations. NSMC scientists presented updates to their plans for the FY-4 series; 4A in 2016 will demonstrate the new imaging, sounding, and lightning mapping capabilities and perform a technological test for geo-microwave, 4B in 2018 will evolve the imager and sounder instruments into operations and introduce a high speed imager for rapid scan, 4C in 2020 will fine tune the operational instruments. 15 recommendations were made for CMA administrator Guoguang Zheng to consider; he welcomed the input and urged NSMC to assign a task force to each recommendation.

##### ***Participation in AOMSUC-6***

At the sixth Asia-Oceania Meteorological Satellite Users' Conference (AOMSUC-6), held in Tokyo, Japan from 9 – 11 November 2015, WPM served on the International Conference Steering Committee, presented a poster on “Creating a high spatial resolution CO<sub>2</sub> sensitive 13.3 μm channel for AVHRR and VIIRS,” and gave a training session on “Using HYDRA2 to study new satellite data.” There was considerable interest from CMA and JMA in HYDRA2 visualization of AHI data (which had been arranged by Tom Rink earlier in November).

##### ***Evolving the HYDRA Toolkit***

The HYDRA data visualization toolkit used in the training boot camps has been further improved, tested, and added to the Community Satellite Processing Package (CSPP); it now enables quantitative interaction with data from AIRS, AMSU, ATMS, AVHRR, HIRS, IASI, MODIS, MHS, VIIRS, and MERSI. A paper “HYDRA2 – A Multispectral Data Analysis Toolkit for sensors on Suomi NPP and other current satellite platforms” has been accepted for publication in BAMS. HYDRA2 can now be used with direct broadcast and archived data from sensors



onboard the NOAA/NASA Suomi National Polar-orbiting Partnership (S-NPP), NASA Aqua/Terra, EUMETSAT MetOp, and Chinese Feng Yun-3 platforms.

### ***Co-authoring an AMS Monograph on Verner Suomi***

WPM is one of the co-authors (with John Lewis as the lead-author) of a book intended for AMS publication (tentatively titled Verner Suomi: His View of Weather and Climate from Space) that has been in preparation for 3+ years now. It is getting close to a reviewable form. The writing team has worked in unison with a continuing series of teleconferences (at roughly 4-6 month intervals). The final assignments have been made and a manuscript is planned to be ready for review at AMS by end of March 2016; WPM is responsible for chapters on “Imaging the Earth” and “The Panoramic View of Suomi.”

## **9.2 McIDAS-V Support for GOES-R Development**

**CIMSS Task Leader: Tom Rink**

**CIMSS Support Scientist: Joleen Feltz**

**NOAA Collaborators: Tim Schmit, Ralph Petersen**

**Budget: \$30K**

### **NOAA Long Term Goals:**

- Climate Adaptation and Mitigation
- Weather-Ready Nation

### **NOAA Strategic Goals:**

- Serve society’s needs for weather and water
- Understand climate variability and change to enhance society’s ability to plan and respond
- Provide critical support for the NOAA mission

### **CIMSS Research Themes:**

- Satellite Meteorology Research and Applications
- Satellite Sensors and Techniques
- Environmental Models and Data Assimilation
- Education and Outreach

### **Objective**

Develop Interactive, 3D Visualization of Wind Parcel Trajectories.

### **Project Overview**

Design and develop forward/reverse wind parcel trajectory computation and visualization through 2D/3D, earth navigated, gridded Eulerian wind fields with interactive control in McIDAS-V. Potential applications relevant to GOES-R, and under development, include: display 3D trajectories through time based on ABI retrieved Aerosol optical depth (AOD) and numerical model wind forecast, visualize the forward trajectories of parcels in the vicinity of volcanic eruption with respect to ash/SO<sub>2</sub> retrievals, trace conservative atmospheric stability parameters such as Equivalent Potential Temperature from NWP or analysis wind field.

### **Milestones with Summary of Accomplishments and Findings**

Developed necessary software infrastructure incrementally: 2D domains with no time interpolation of (u,v) components first, then implemented an extendable spatial-temporal



interpolation algorithm for parcel displacement, followed by full support for 3D+Time trajectory computation and visualization. Developed multiple trajectory visual depiction types including basic line, kinematic derived deformable ribbons, and shaded, fixed width cylinders. Implemented interactive control including adjustable time visibility window, trajectory density, and support for arbitrary starting locations. Trajectory depictions can be colored by an initial scalar field, e.g. a conservative parameter such as Potential Temperature, or non-conservative such as smoke density, or according to a time varying parameter like speed. High spatial and temporal resolution can be computationally challenging, particularly with 3D domains, so interpolation and parcel displacement are performed “lazily”, i.e. only on grid cells containing a trajectory path. Figure 32 shows only a single time of an animation sequence for hurricane Sandy computed from the Non-Hydrostatic Mesoscale Model (NMN) at 8km resolution at 10min model intervals. Figure 33 shows volumetric computed trajectories on a subset of the RAPS domain between 200 and 1000 mb, depicted as fixed width cylinders which can be shaded for enhanced depth perception along with a perspective display projection. Again, only a single time step of the time sequence is shown.

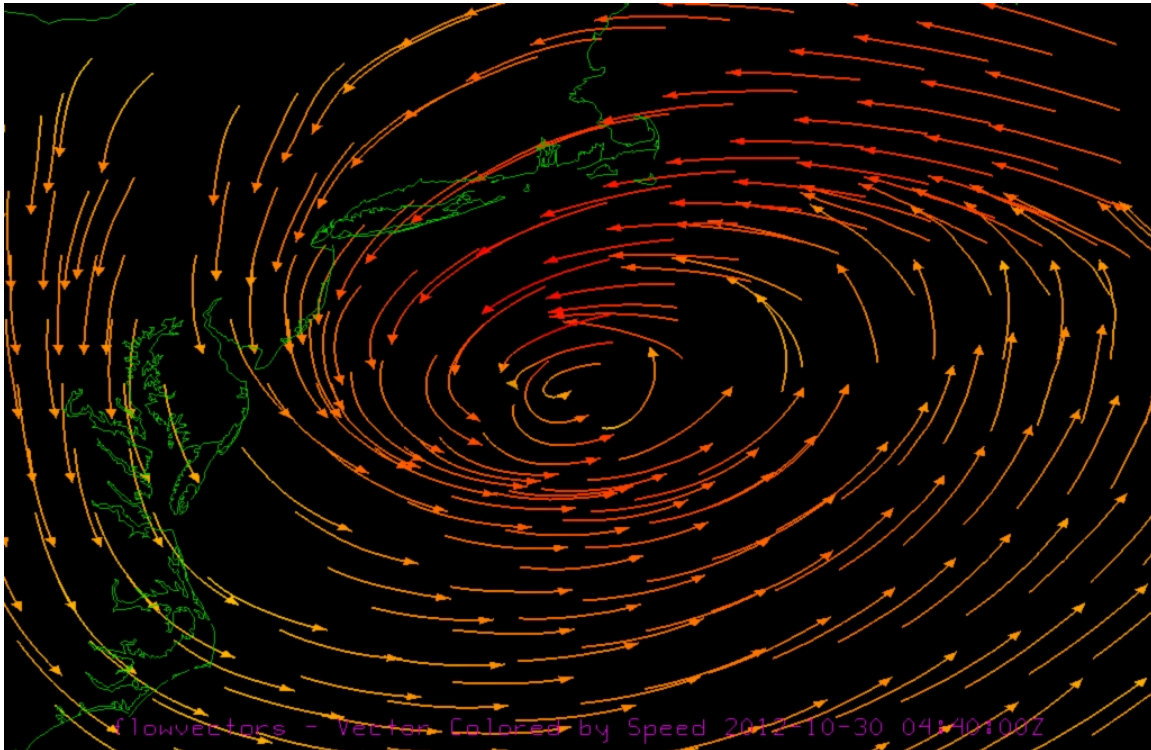

Figure 32. Wind parcel trajectories on 850mb during hurricane Sandy and colored by speed



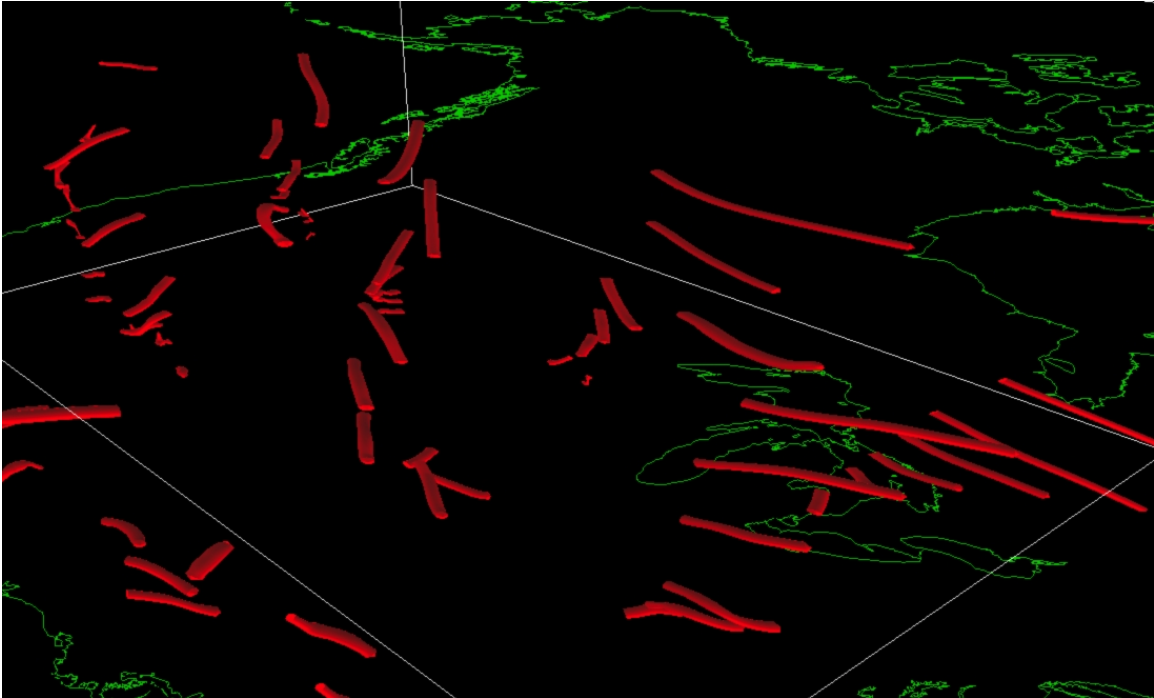

Figure 33. Wind parcel trajectories depicted as shaded cylinders (for better depth perception) computed in a RAPS 3D domain.

#### **Publications and Conference Reports**

AMS Annual Meeting (IIPS): 2005-2015

AMS Satellite Meteorology Conference: 2007, 2009, 2010, 2012, 2015

AGU Fall Meeting: 2005, 2007-2011

SPIE Photonics: 2007-2011

NOAA Direct Broadcast: 2008, 2011

GOES-R User's Conference: 2009 (workshop), 2010, 2011

EUMETSAT Satellite Conference: 2008 (workshop), 2009-2013

International TOVS Working Group Meeting: 2007, 2008, 2010 (workshop), 2012, 2013

McIDAS Users Group: 2006-2015 (workshops 2008-2015)

### **10. Implementing the GOES-R Future Capability Ice Products into the GOES-R Processing System**

**CIMSS Task Leader: Yinghui Liu**

**CIMSS Support Scientist: Xuanji Wang**

**NOAA Collaborator: Jeffrey Key**

**Budget: \$171,000**

#### **NOAA Long Term Goals**

- Climate Adaptation and Mitigation
- Weather-Ready Nation

#### **NOAA Strategic Goals:**

- Serve society's needs for weather and water
- Understand climate variability and change to enhance society's ability to plan and respond



- Provide critical support for the NOAA mission

#### **CIMSS Research Themes:**

- Satellite Meteorology Research and Applications

#### **Objective**

Implement three ice-related GOES-R ABI future capability products into the GOES-R Processing System.

#### **Project Overview**

The National Weather Service advisory team for the GOES-R program recently recommended that five future capability (formerly “option 2”) GOES-R ABI products be transitioned to operations. Some years ago, many of the original ABI products were reclassified from “baseline” to “future capability” due to budgetary constraints. Now five of those will be implemented in the Harris GOES-R Processing System. They are: Cloud Cover Layers, Aerosol Particle Size, Ice Concentration, Ice Age/Thickness, and Ice Motion.

The purpose of this project is to implement the three GOES-R Advanced Baseline Imager (ABI) future capability products into the GOES-R Processing System. CIMSS will work with the STAR Algorithm Implementation Team (AIT) and the contractor (Harris) to implement the following three ice products:

1. Sea ice concentration
2. Sea ice thickness/age
3. Sea ice motion

These products were developed by CIMSS and NOAA for ABI.

#### **Milestones with Summary of Accomplishments and Findings**

- Implemented the sea ice algorithms for use with Himawari-8 AHI data.
- Updated the Algorithm Theoretical Basis Documents (ATBD) that were originally written for ABI. (March 2016)
- Science team updated and delivered algorithm to the AIT for integration into the Framework.
- Monthly reporting.

A number of Himawari-8 AHI images that are suitable for high-latitude work have been acquired. Cases are from February and March 2015. The algorithms listed above have been modified for use on the AHI data. Ice surface temperature and concentration using ice algorithm developed for GOES-R ABI with Himawari-8 AHI data as input show reasonable retrieval values and spatial distribution as shown in Figure 34.

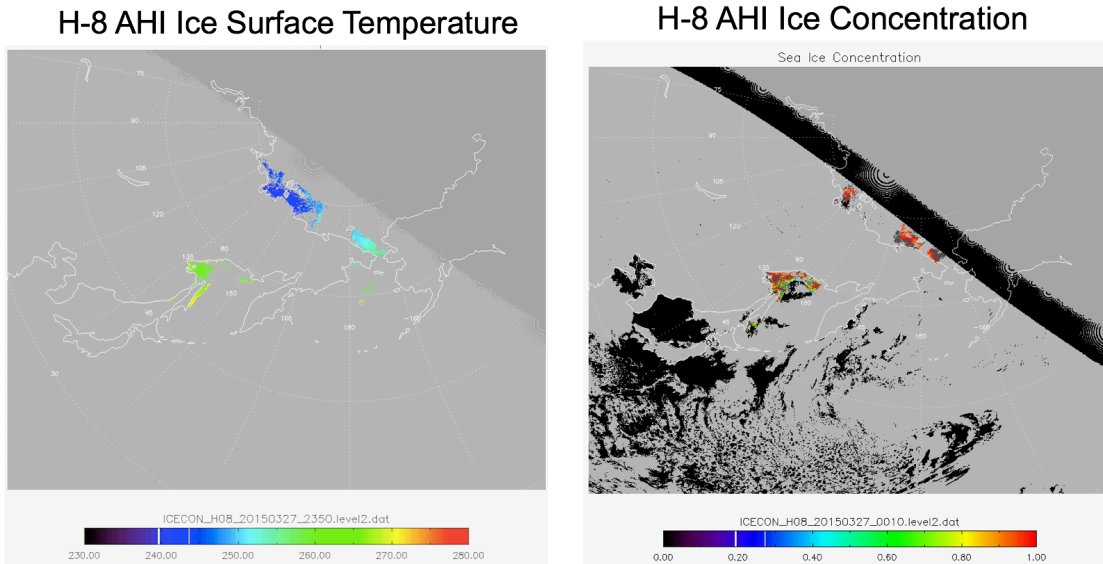

Figure 34. Ice surface temperature and ice concentration using ice algorithm developed for GOES-R ABI with Himawari-8 AHI data as input on March 27, 2015.

### References

Liu, Y.; Key, J.; Tschudi, M.; Dworak, R.; Mahoney, R.; Baldwin, D. Validation of the Suomi NPP VIIRS Ice Surface Temperature Environmental Data Record. *Remote Sens.* 2015, 7, 17258-17271.

Y. Liu, J. Key and R. Mahoney: Sea ice concentration from VIIRS on Suomi NPP and the future JPSS Satellites. Submitted to *Remote Sensing*.

## 11. GOES-R Future Capability: SO<sub>2</sub> Detection

**CIMSS Task Leader: John Cintineo**

**CIMSS Support Scientist: Justin Sieglaff**

**NOAA Collaborator: Mike Pavolonis**

**Budget: \$75,000**

### NOAA Long Term Goals:

- Weather-Ready Nation

### NOAA Strategic Goals:

- Serve society's needs for weather and water
- Support the nation's commerce with information for safe, efficient and environmentally sound transportation
- Provide critical support for the NOAA mission

### CIMSS Research Themes:

- Satellite Meteorology Research and Applications
- Satellite Sensors and Techniques



## Objective

We will utilize the VOLCAT system and expand the VOLCAT system to detect and characterize sulfur dioxide clouds in addition to volcanic ash clouds.

## Project Overview

The GOES-R ABI will have the unique capability to detect and characterize SO<sub>2</sub> clouds from a geostationary orbit. The GOES-R Algorithm Working Group (AWG) developed an ABI SO<sub>2</sub> detection algorithm to take advantage of this capability (Pavolonis and Parker, 2010). The SO<sub>2</sub> detection algorithm utilized infrared channels that are sensitive to SO<sub>2</sub> absorption, specifically the 7.3 and 8.5 μm channels. These spectral channels, combined with the 11 and 12 μm channels, were used to distinguish SO<sub>2</sub> clouds from all other features. At the 80% code delivery, the GOES-R AWG SO<sub>2</sub> algorithm was very close to meeting the performance specification of 70% correct detection for SO<sub>2</sub> concentrations 10 Dobson Units or greater (actual correction detection accuracy was 64%).

The timely detection of SO<sub>2</sub> is important to aviation and, as such, SO<sub>2</sub> detection (and volcanic ash detection) is a priority of the National Weather Service. Through GOES-R Risk Reduction, a fully automated volcanic ash cloud alerting system was developed. The system automatically alerts users to the presence of new volcanic ash clouds in near real-time with an accuracy that is comparable to a trained human expert. The automated notification of volcanic hazards is absolutely critical, as even current data volumes prohibit manual analysis of all satellite images. The increase in data volume with GOES-R will make manual analysis even more challenging. The automated system, known as the Volcanic Cloud Analysis Toolkit (VOLCAT), utilizes spectral, spatial, and temporal metrics provided by the GOES-R ABI and other sensors to detect and characterize volcanic ash clouds. (VOLCAT can actually be applied to nearly any geostationary or low earth orbit sensor.) Volcanic ash detection techniques and previous GOES-R AWG SO<sub>2</sub> algorithm development have been leveraged to incorporate SO<sub>2</sub> detection capability within the VOLCAT system. Within VOLCAT, we can then readily merge information from high spectral resolution low-earth orbit IR sensors with geostationary satellite data to further improve the GOES-R SO<sub>2</sub> detection and property retrieval products.

## Milestones with Summary of Accomplishments and Findings

- *Continue to develop SO<sub>2</sub> detection capability within the VOLCAT system, leveraging previous research efforts.*

Similar to volcanic ash, a cloud object based approach is utilized to detect SO<sub>2</sub>. The approach also employs radiative transfer theory, a statistical model, and image processing techniques to identify SO<sub>2</sub> in satellite imagery with skill comparable to that of a human expert (e.g., Pavolonis et al. 2014a; Pavolonis et al. 2014b). An extensive training dataset has been further developed using MODIS spectral data from several explosive eruptions in the recent past (e.g., Kasatochi 2008, Sarychev 2009, Redoubt 2009, and others) containing large amounts of SO<sub>2</sub>, as well as more recent events of non-explosive SO<sub>2</sub>-producing volcanoes (e.g., Bardabunga 2014, Fogo 2014). This dataset has been manually analyzed by an expert to isolate areas of SO<sub>2</sub>. Certain spectral properties of unique interest to SO<sub>2</sub> detection will be extracted from within the spatial bounds of these identified regions and used to train the statistical model of the algorithm, similar to what was done for the training of volcanic ash clouds.

Leveraging past research efforts of creating an alerting capability for volcanic ash clouds, VOLCAT software has been modified for inclusion of SO<sub>2</sub> alerting. This will enable users to quickly and seamlessly receive SO<sub>2</sub> alerts in addition to the volcanic ash alerts.



The pertinent SO<sub>2</sub> information will be presented analogously to the volcanic ash alerts, along with a highlighted and annotated image (see Figure 35 for an example how an SO<sub>2</sub> alert may look).

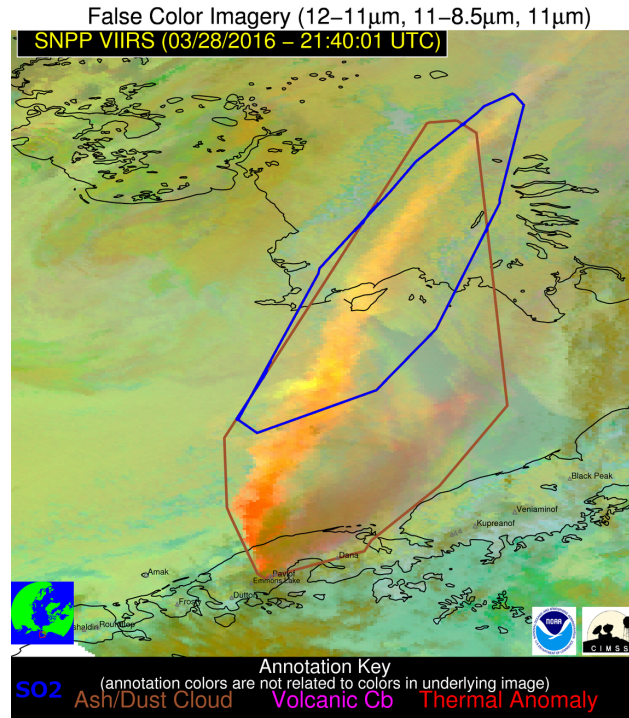

Figure 35. Example image from SO<sub>2</sub> alert that will be produced by VOLCAT, with SO<sub>2</sub> cloud annotated in blue.

## References

Pavolonis, M.J. and A. Parker, 2010: GOES-R Advanced Baseline Imager (ABI) Algorithm Theoretical Basis Document for SO<sub>2</sub> Detection, [http://www.goes-r.gov/products/ATBDs/option2/Aviation\\_SO2\\_v1.0\\_no\\_color.pdf](http://www.goes-r.gov/products/ATBDs/option2/Aviation_SO2_v1.0_no_color.pdf).

Pavolonis, M.J., J. Sieglaff, and J. Cintineo, 2014a: Spectrally Enhanced Cloud Objects (SECO): A generalized framework for automated detection of volcanic ash and dust clouds in satellite imagery, Part I: Multi-spectral Analysis, Submitted to *J. Geophys. Res. Atmos.*

Pavolonis, M.J., J. Sieglaff, and J. Cintineo, 2014b: Spectrally Enhanced Cloud Objects (SECO): A generalized framework for automated detection of volcanic ash and dust clouds in satellite imagery, Part II: Cloud Object Analysis and Global Application, Submitted to *J. Geophys. Res. Atmos.*

## 12. Identification of GOES-R Storm Top Features

**CIMSS Task Leader: Pao K. Wang**

**NOAA Collaborator:**

**Budget: \$80,000**

### NOAA Long Term Goals:

- Weather-Ready Nation



### **NOAA Strategic Goals:**

- Serve society's needs for weather and water
- Support the nation's commerce with information for safe, efficient and environmentally sound transportation
- Provide critical support for the NOAA mission

### **CIMSS Research Themes:**

- Satellite Meteorology Research and Applications
- Satellite Sensors and Techniques

### **Objective**

Find visible and IR features seen in satellite storm imagery that can be used as indicators for severe storm nowcasting and forecasting.

### **Project Overview**

Severe storms impose substantial risk on human lives and property and influence the economic activity of human society greatly. This project aims at finding visible and IR features seen in satellite storm imagery that can be used as indicators for severe storm nowcasting and forecasting. Many visible and infrared features at the top of thunderstorms as observed by meteorological satellites are intimately related to the physics and dynamics in the most active part of the storm. By identifying these features and investigating the physical processes responsible for generating these features, much information about the current state of the storm can be retrieved from satellite images which can then be used for the purpose of storm forecasting/nowcasting purpose. In this project, we utilize a physics-based cloud resolving model to simulate thunderstorm processes so as to see if the simulated storm exhibits the same visible and IR features as observed. If the simulating is successful, then we use the model physics to explain the physical processes responsible for producing these features. The characteristics of the features so identified and physically interpreted can be used to form quantitative relations between them and physical variables of the storm (e.g., winds, updraft, humidity, turbulence, etc.). Such relations will serve as the basis for quantitative retrieval of storm properties. We propose to continue examining existing and identifying new storm top features and studying the physics and dynamics responsible for producing them.

### **Milestones with Summary of Accomplishments and Findings**

In this period, we studied the situation of the storm top features when upper level wind shear is weak or absent. This is partially motivated by the observation of the "cold ring" feature in some storm IR images as first discussed by Martin et al. (2010) and an example is shown below.

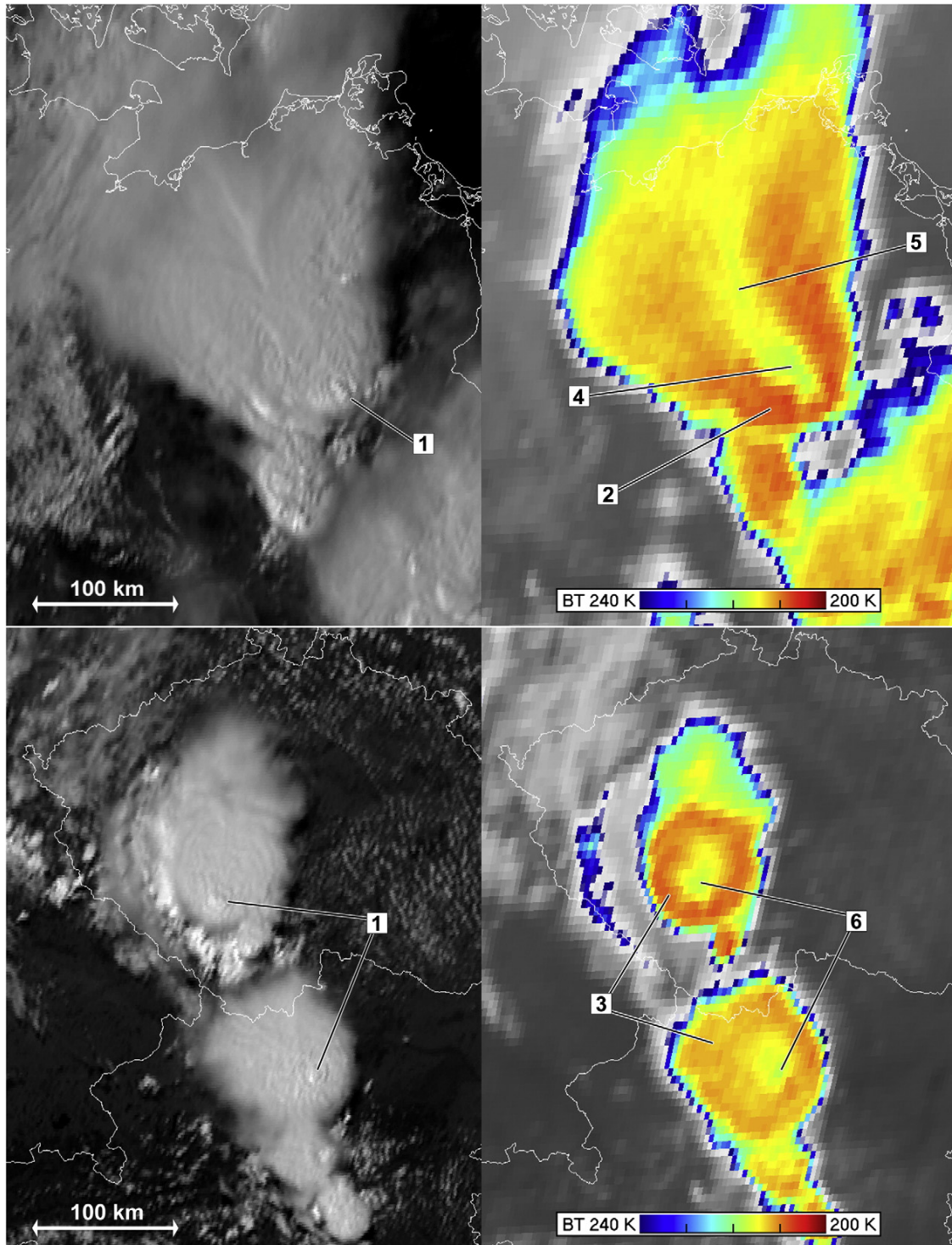
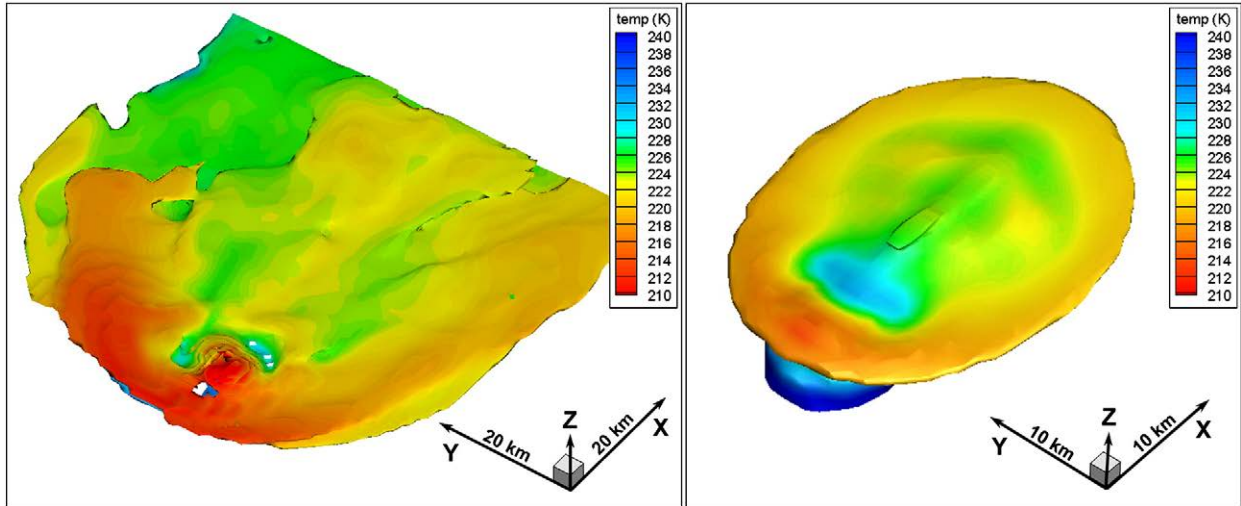

Figure 36. Examples of cold-U shaped storms — top (Meteosat-9, 26 May 2007, 15:00 UTC, Germany) and cold-ring shaped storms — bottom (Meteosat-8, 25 June 2006, 13:45 UTC, Czech Republic and Austria). Left: high resolution visible (HRV) images, right: color enhanced IR10.8 images. Legend: 1—overshooting tops, 2—cold-U shape, 3—cold ring shapes, 4—close-in warm area (CWA), 5—distant warm area (DWA), 6—central warm spots (CWS). Both cases are shown in the same scale and enhancement. Time labels in this figure refer to the beginning of the scan of the image slot.

When examining the cases in this figure, it is immediately clear that the storms with cold-U feature has higher wind shear at upper level than those with cold ring feature. Thus we performed a sensitivity study utilizing cloud model WISCDYMM simulation of a standard severe storm (CCOPE supercell, 2 August 1981) under the conditions of (1) original wind shear and (2) small wind shear. The results are shown in Figure 37:



**Figure 37.** WISCDYMM model simulations. a. (left): Cloud top temperature field of the simulated CCOPE supercell at  $t=7200$  sec. b. (right): Cloud top temperature field of the simulated storm at  $t=1800$  sec using the idealized soundings. The cloud top in both figures is represented by the 90% RH<sub>i</sub> iso-surface, temperature scales are identical. Spatial orientation with respect to the model grid and horizontal scales are indicated in lower right corners of each image; please note that the horizontal scales differ for the two images.

The left panel of Figure 37 shows the simulated storm top temperature field using the original sounding which shows the Cold-U feature. The right panel shows the case of small wind shear and the temperature field exhibits the cold ring feature. This made us to believe that wind shear has strong influence on the storm top behavior.

We therefore performed a model study assuming the total absence of wind shear to see if the results show even clearer cold ring feature. The results confirmed our hypothesis, as seen in Figure 38. This ring appears at an early stage of the storm development. As the storm continues to grow, storm top becomes unstable and a jet appears at the center followed by the breakup of the jet into a pancake-like cloud (pancake cloud) as seen in Figure 39. The temperature change in later stages appears to be more complicated. We believe that the elucidation of the evolution of storm top temperature change will be very helpful to storm nowcast and forecast based on GOES satellite IR data.



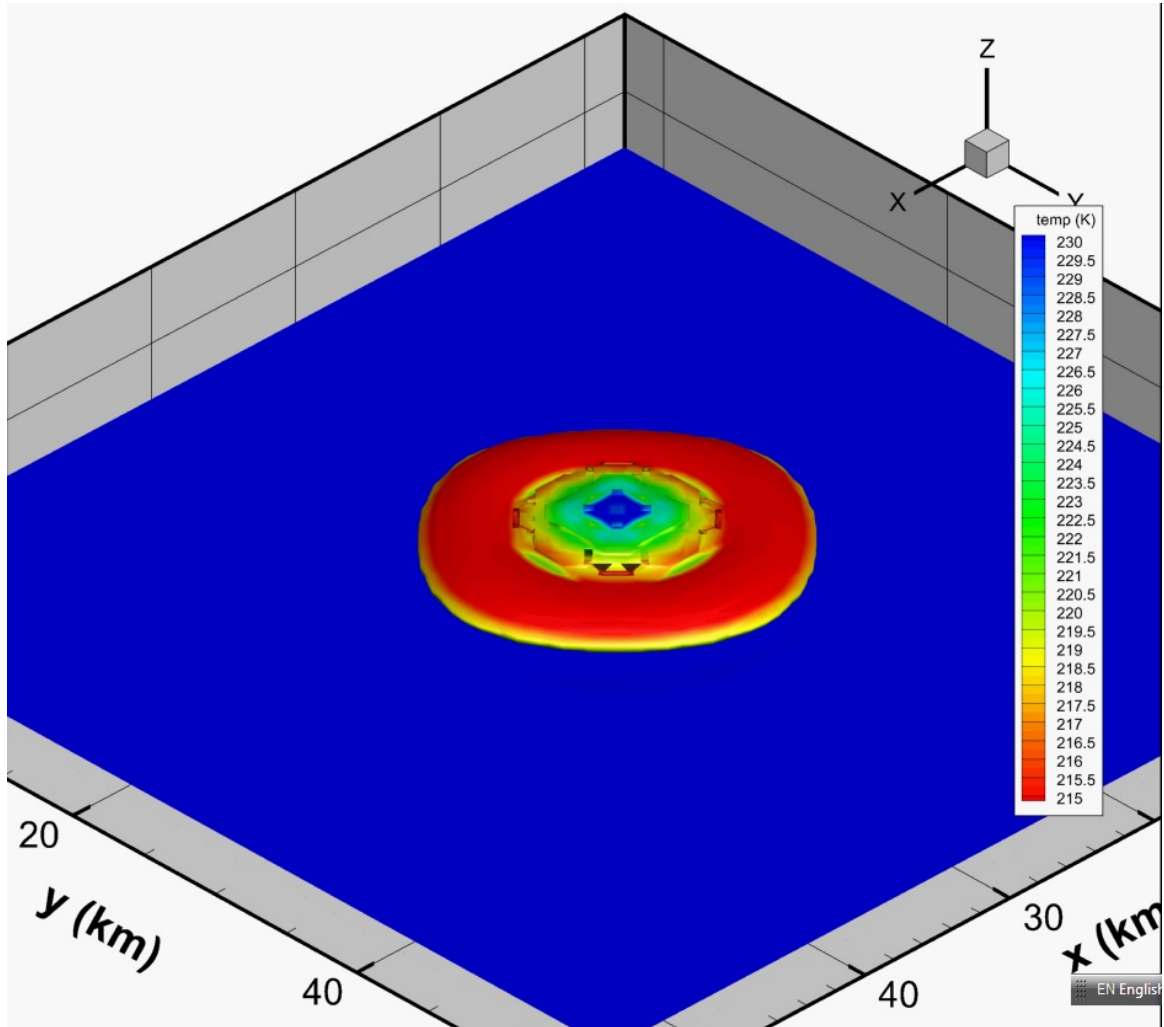

Figure 38. Simulated storm top temperature of the shear-less CCOPE supercell showing a symmetric cold ring (red) at the storm top. Inside the ring is a warm area (blue). The cold ring appears in the early stage of the storm.

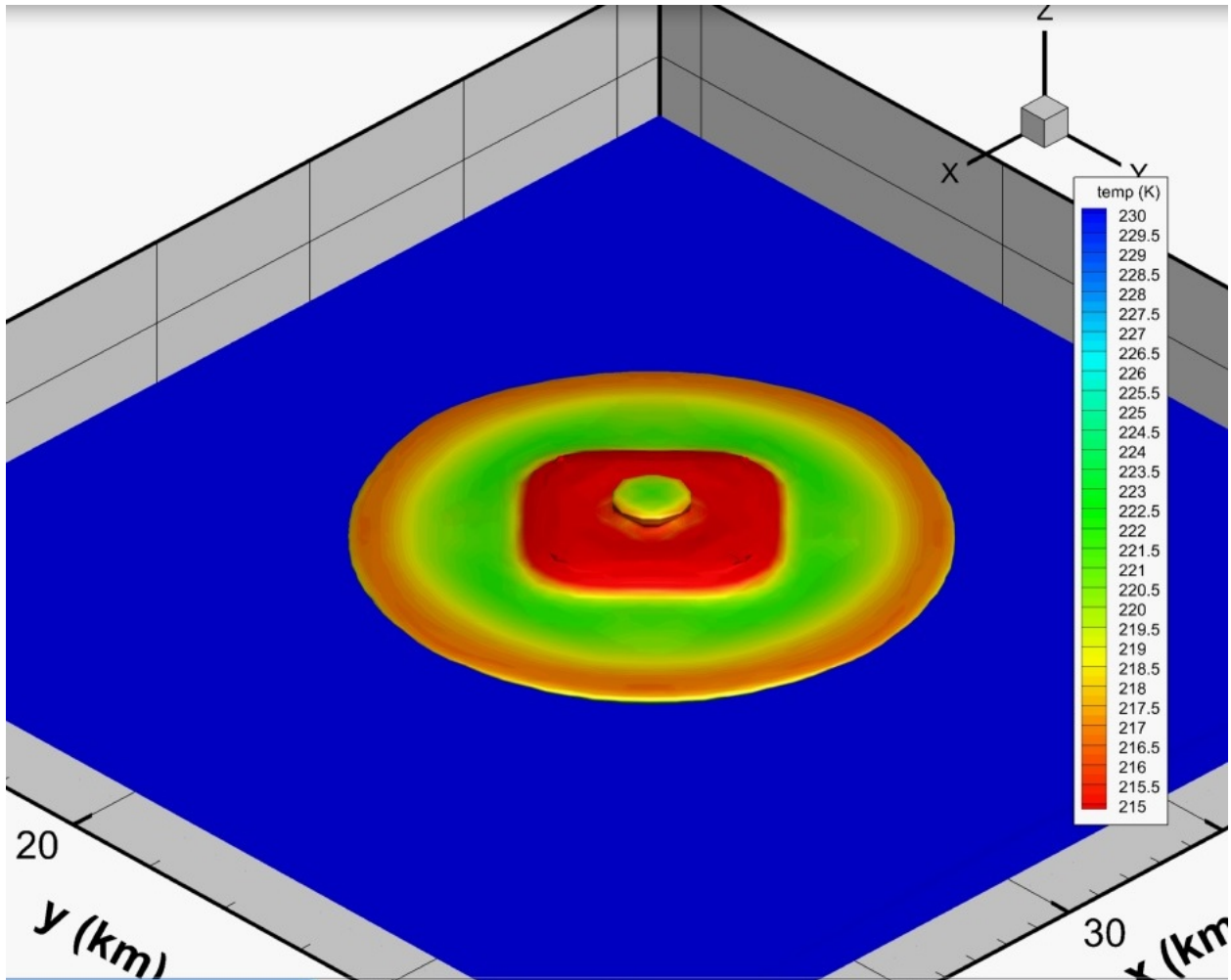

Figure 39. Simulated storm top temperature of the shear-less CCOPE supercell at a later stage showing a symmetric cold ring (orange) larger than that in Figure 38 and a generally cold area in the center with a warm “pancake cloud” appearing on top of the cold patch. The pancake cloud appears to be produced by the Rayleigh-Taylor instability at the storm top.

### Publications and Conference Reports

Wang, P. K., K. Y. Cheng, M. Setvak, and C. K. Wang, 2016: The origin of the gullwing-shaped cirrus above an Argentinian thunderstorm as seen in CALIPSO images. *J. Geophys. Res. Atmos.*, 121, doi:10.1002/2015JD024111

Wang, P.K., 2016: Physics of Satellite-observed features on top of severe storms. EUMETSAT Convection Working Group Workshop, 04-08 April 2016, Florence, Italy.

### 13. Development of a Geostationary Community Satellite Processing Package (CSPP)

**CIMSS Task Leaders: Liam Gumley (PI), Graeme Martin (PM)**

**CIMSS Support Scientists: Nick Bearson, Jessica Braun, Geoff Cureton, Ray Garcia, Tommy Jasmin, Scott Mindock, Kathy Strabala.**



**NOAA Collaborators: Steve Goodman, Satya Kalluri, Andrew Heidinger, Michael Pavolonis, Walter Wolf**  
**Budget: \$528K**

**NOAA Long Term Goals:**

- Weather-Ready Nation

**NOAA Strategic Goals:**

- Serve society's needs for weather and water
- Provide critical support for the NOAA mission

**CIMSS Research Themes:**

- Satellite Meteorology Research and Applications
- Satellite Sensors and Techniques

**Objective**

The CSPP Geo team develops and distributes software allowing direct broadcast users to process data from geostationary satellites. The primary goal is to support processing of GOES Rebroadcast (GRB) data from the upcoming GOES-R mission. Additional goals are to support processing direct broadcast data from the current GOES and Japanese Himawari-8 missions.

**Project Overview**

As of this reporting period, the following software is available for public download via the CSPP Geo website: 1) the **GVAR package**, capable of processing current GOES imager data in real-time as received via the GVAR data stream, and 2) the **GRB package**, capable of processing GOES-R instrument data in real-time as it will be received via the GRB stream. In addition, Advanced Himawari Imager (AHI) data conversion utilities have been provided to users.

As of the latest release, the GRB package generates products for all GOES-R instruments: the Advanced Baseline Imager (ABI), Geostationary Lightning Mapper (GLM), Solar Ultraviolet Imager (SUVI), Extreme Ultraviolet and X-ray Irradiance Sensors (EXIS), Space Environment In-Situ Suite (SEISS), and Magnetometer (MAG).

Software packages are currently being developed at CIMSS/SSEC to generate Level 2 products using research versions of algorithms developed under GOES-R AWG. Initially, support will be offered for current GOES Imager data, with support for AHI and ABI to be added later. By allowing users to run algorithm software developed for GOES-R on currently available data from other instruments, we hope to familiarize users with the software and products before the launch of GOES-R, improve the quality of the software and products, and to provide products that are themselves useful in forecasting and other applications.

CSPP Geo software is free to download and easy to install and run, with a high level of support provided by the CSPP Geo team. The software runs on Linux machines, and all required third party software is bundled. Test datasets are provided, allowing users to verify that the installation succeeded and the software is operating correctly.

Based on our experience in developing similar software for [Polar Orbiter Instruments](#), we expect that the benefits of this project to [NOAA](#) and to the direct readout community will include:

- Promoting the use of the GOES-R data products and science software,
- Encouraging early use of GOES-R data among users,

- Encouraging vendors to provide early support for GOES-R data,
- Encouraging DB users to be ready to process GOES-R data on day one,
- Allowing DB users to stay updated on versions of the operational product algorithms,
- Allowing DB users to develop new products, or tailor products to local conditions, and
- Providing a catalyst for involving the direct readout community in GOES-R calibration and validation.

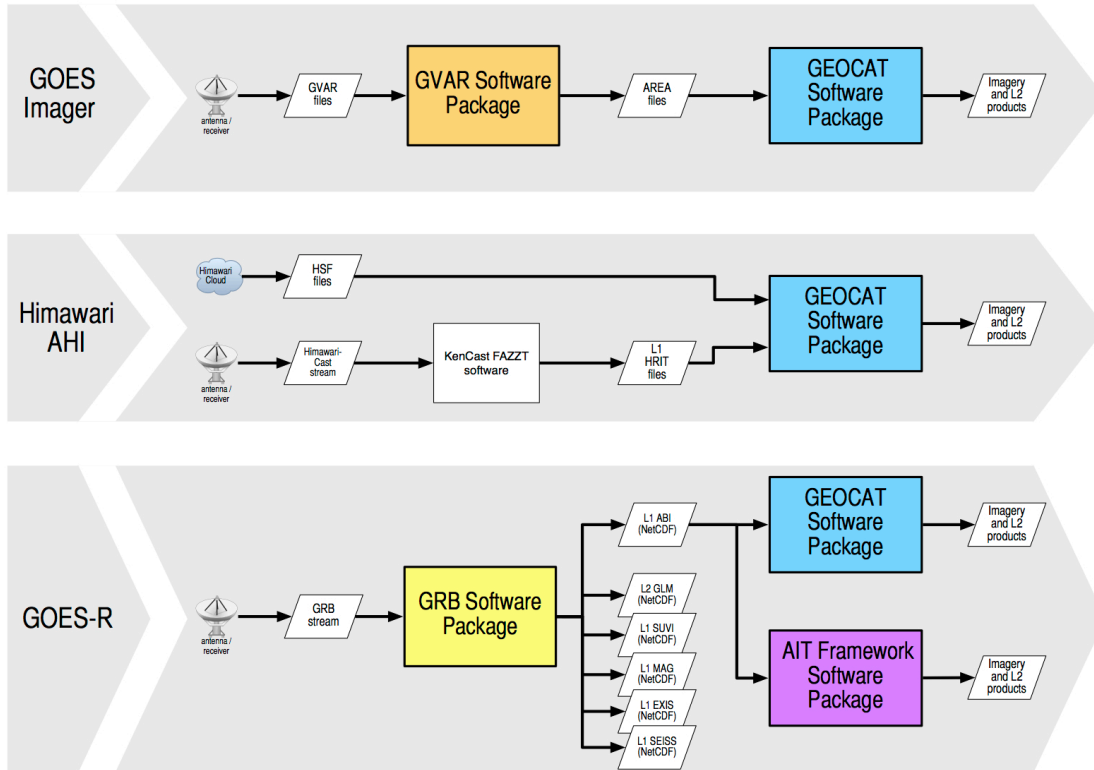

Figure 40. CSPP Geo data flow diagram showing current and future software packages and processing chains

### Milestones with Summary of Accomplishments and Findings

The CSPP Geo team made progress on the following tasks and associated milestones during the reporting period:

- Developing and releasing software to process data that will be received from the GOES-R satellite via the GRB stream;
- Developing and distributing software and tools to process data from the AHI instrument on the Japanese Himawari-8 satellite;
- Developing the GEOCAT Level 2 software to process data from multiple instruments in collaboration with AWG science teams, and maintenance of a public-facing ancillary data server;
- Beginning collaboration with the GOES-R Algorithm Integration Team (AIT) and beginning work on integration of the AIT Framework into CSPP Geo;
- Cross-cutting activities related to software development; and
- Supporting users and preparing them to receive GRB data, as well as developing and maintaining the CSPP Geo website for dissemination of software, documentation and information.



### ***CSPP Geo GRB Software***

Prototype version 0.3 of the GRB Software Package was released on October 6, 2015. This is a critical piece of infrastructure that will allow users to process the CADU-framed CCSDS packets that make up the GRB stream, generating Level 1 products from the ABI and space weather instruments, and Level 2 GLM products. The software was developed in accordance with the GRB specification in the GOES-R Product Definition and Users' Guide (PUG), and was tested on the most up-to-date GRB proxy data available.

This version added support for the remaining two GOES-R instruments: EXIS and SUVI, with the ability to optionally create the SUVI product in FITS file format. This version also added greater software configurability, and improvements to performance and runtime behavior. A test data package was provided to users, along with a sender script that frames data as CADUs and streams it over dual sockets, simulating the GRB data stream at the expected data rate, thereby allowing users to test the capabilities of their processing systems.

Extensive testing was done using multiple simulated GRB datasets, to evaluate the robustness of the software and potentially flush any data format or edge case handling issues. Testing was done with data from the Harris GRB simulator, and DOE and GRE data obtained from tests of the operational ground system. We obtained and compiled the GOES-R Ground System Data Simulator (GSSIM), which we expect will provide an additional test path incorporating live data generated by the GOES-R Proxy team.

Development activities following the GRB software release were focused on performance optimizations, internal refactorings, improved logging, handling of edge cases, as well as preliminary work on a streaming data interface.

During this period we reviewed Rev D of the PUG and provided feedback to the Program Office, and participated in the quarterly GRB Working Group meetings led by Harris Corporation.

### ***Himawari Software Development***

The CSPP Geo team made progress on developing software that will allow direct broadcast users to process data from the AHI instrument. CSPP Geo software will be provided to process data in both the full-resolution Himawari Standard Data (HSD) format distributed by JMA via the cloud, and the reduced-resolution HimawariCast format distributed via direct broadcast.

We contributed to an open source and publicly available Himawari ingest library that is maintained at CIMSS/SSEC, adding support for reading and converting data in the HimawariCast HRIT format. Using this library, we developed a tool to convert data from the HimawariCast stream to SCMI-compatible NetCDF files, which is being used routinely at NWS offices in Hawaii and Guam to format data for use in AWIPS-2.

Sample HimawariCast data was obtained from the operators of antennas in the Asia-Pacific region, and later a link was established supplying real-time HimawariCast data from a NWS antenna in Hawaii. NOAA STAR also provided a real-time feed of AHI data in HSD format. These sources of real AHI data are critical in developing and testing software and providing user support.

### ***GEOCAT Level 2 Software***

The GEOCAT package will allow users to generate Level 2 products using research version of algorithms that were developed for GOES-R. The initial version will support processing data



from current GOES Imager (currently in alpha testing), and subsequent releases will add support for AHI and ABI (planned for later in 2016).

Development activities included working with algorithm developers to obtain updated algorithms and LUTs, and to verify output; developing common scripting infrastructure to handle job sequencing, ancillary data download, data caching, error handling and logging; working with GEOCAT core developers to resolve issues; developing build and packaging scripts and infrastructure; creating a NetCDF4 file format and data converter, and documentation.

During this period work was begun on adding support for processing AHI data, including planning and preliminary work on multi-processing, which will be required to keep up with the large data volume.

The CSPP Geo team continued to maintain a public-facing ancillary data distribution server, routinely posting the NWP and other dynamic ancillary data required by GEOCAT.

### ***AIT Framework Software***

The AIT Framework is an algorithm testbed that is developed and maintained by the GOES-R AIT, led by Walter Wolf and Shanna Sampson. It runs research versions of most of the algorithms that were developed for GOES-R. As a CSPP Geo package, the AIT Framework will allow direct broadcast users to generate a potentially large number of the GOES-R products, and provide a path for distributing algorithm updates.

Collaboration with the AIT began in January 2016. We have been receiving and building regular drops of source code, and have identified candidate Level 2 algorithms to be included in the initial release. Development efforts will ramp up later in 2016.

### ***Cross-cutting Software Development Activities***

We made progress on various tasks related to software development and spanning multiple software packages, including: developing “quicklook” image plotting software and common specifications; starting work on “composite RGB” imagery software; developing testing infrastructure; static build and bundling of third-party COTS libraries; developing packaging automation and processes; evaluation, installation and maintenance of third-party development and productivity tools, and maintenance of VMs for developing, testing, building and packaging CSPP Geo software. For many of these tasks we leveraged code and processes that had been developed by the CSPP project under separate funding.

### ***User Support and Public Relations***

The CSPP Geo team connected with users and potential users during this period, answering questions regarding the capabilities and hardware requirements of software packages, and helping the users with their planning for GOES-R and Himawari data reception and processing. CSPP Geo project status and plans were presented in talks and posters at the ITSC-XX conference in Lake Geneva, WI, and the 2016 AMS Conference in New Orleans, LA. We hosted visitors from INPE and GINA, and interacted with individuals in the National Weather Service, Environment Canada, MeteoFrance, JMA and KMA, as well as vendors of receiving systems and researchers at universities and institutions within the United States.

The CSPP Geo website was maintained as a point of distribution for new software, documentation and information regarding the project and future plans.



GOES-15 Imager, ACHA mode 7 GOES Cloud Optical Depth (visible)  
2015-05-23 21:00z

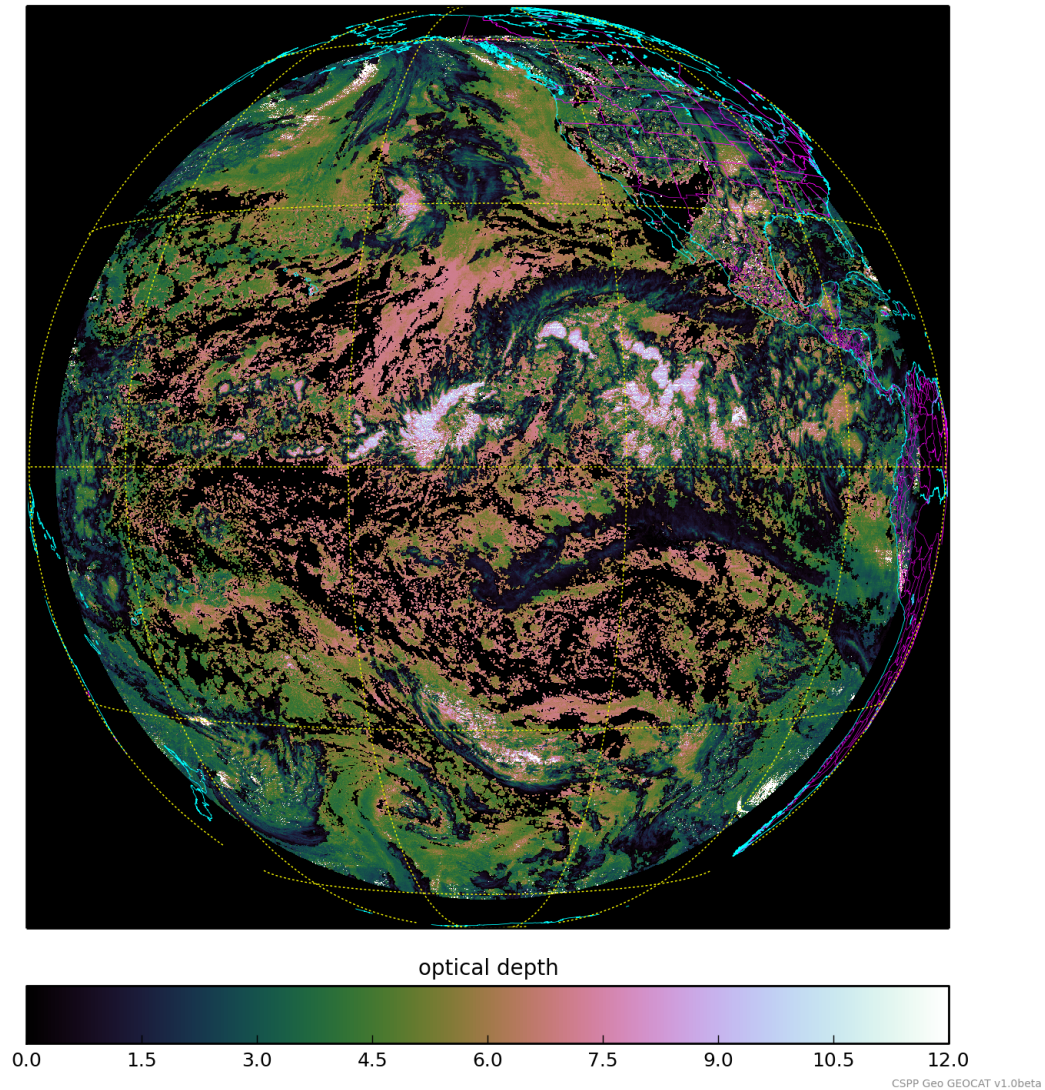

Figure 41. Quicklook image from the CSPP Geo GEOCAT package, show Cloud Optical Depth

#### 14. GOES-R Specific Mobile Apps

**CIMSS Task Leader: Sam Batzli**

**CIMSS Support Scientists: Dave Parker, Nick Bearson, Russ Dengel, Tommy Jasmin, Dave Santek**

**NOAA Collaborators: Tim Schmit, Steve Goodman**

**Budget: \$69K**

#### **NOAA Long Term Goals:**

- Climate Adaptation and Mitigation
- Weather-Ready Nation

#### **NOAA Strategic Goals:**

- Serve society's needs for weather and water



- Understand climate variability and change to enhance society’s ability to plan and respond
- Provide critical support for the NOAA mission

### CIMSS Research Themes:

- Satellite Meteorology Research and Applications
- Education and Outreach

### Objective

To bring GOES imagery and derived products to mobile devices for visualization.

### Project Overview

The launch of GOES-R will bring an unprecedented quality and volume of geostationary satellite imagery to scientists and weather forecasters. All of these new products will be viewable in the RealEarth web browser and related mobile app. However, because of the profusion of GOES imagery and derived products, we are developing a dedicated, GOES-branded complimentary app specifically for GOES imagery and products, called “GOES App.”

### Milestones with Summary of Accomplishments and Findings

Milestone 1: Upgrading WxSat. The RealEarth system already produces and displays more than 450 satellite imagery products and related data products in the web browser. Phase one (nearly complete) upgraded the existing WxSat apps (both iOS and Android) to accommodate all of those existing data products. The new upgrade became a new successor app called “RealEarth.” During this phase, the research team built a working prototype as seen in the following screenshots (Figure 42).

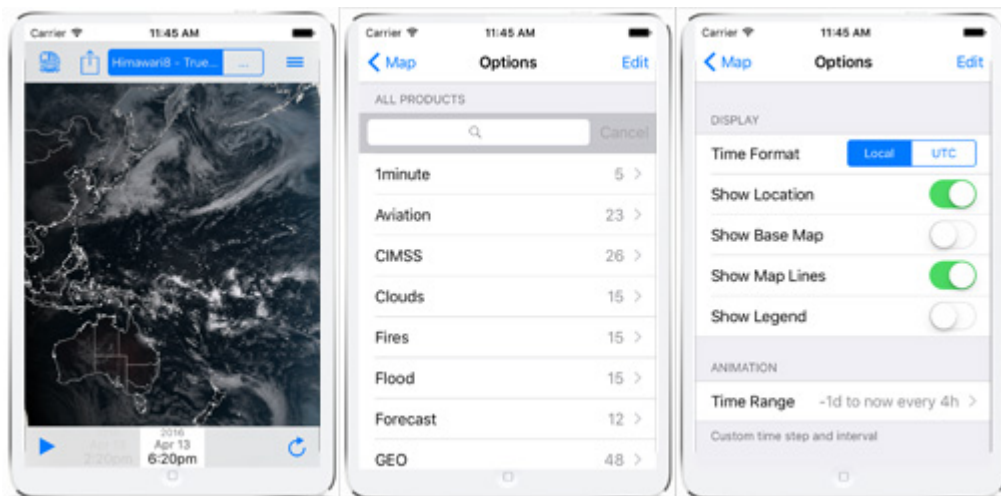

Figure 42. Screenshots from the new prototype “RealEarth” app that provides access to all 450+ RealEarth satellite imagery and related data products. The left image shows an RGB Himawari8 composite, the middle image show the top portion of the RealEarth product selector and the right image shows some of the interface options. The app supports customizable animation.

Milestone 2: Infrastructure Supplement and GOES Product Development. The processing of near real-time imagery for visualization and derivate product development requires significant processing power, memory, and disk space. The RealEarth system is extensible and can be scaled both for production of products and for popularity by end-users. RealEarth is modular and operates in a self-contained virtual machine (VM) environment. That enables duplication and





simplifies deployment. It also allows individual modules of RealEarth to be dedicated to specific product sets. For example, one of the RealEarth VMs is dedicated to producing the three products for the WxSat apps. This isolates it from the processing of the other 450 products and improves dependability and performance for the apps. At the same time, each of the VMs can be registered and linked through a “head node” that can bring the products of individual VMs into the single RealEarth interface. During this year, RealEarth experienced a surge of attention and activity with new users wanting to animate Himawari8 imagery. This prompted the development team to augment our infrastructure to accommodate the increase in processing and user demand. Accommodating data from the new sensors on Himawari has been a good test case in anticipation of the data volume we will receive from GOES-R.

## **15. Implementing the GOES-R Future Capability Cloud Cover Layer Product into the GOES-R Processing**

**CIMSS Task Leader: William Straka III**

**CIMSS Support Scientists: Steve Wanzong and Yue Li**

**NOAA Collaborator: Andrew Heidinger**

**Budget: \$75,000**

### **NOAA Long Term Goals:**

- Weather-Ready Nation

### **NOAA Strategic Goals:**

- Serve society’s needs for weather and water
- Support the nation’s commerce with information for safe, efficient and environmentally sound transportation
- Provide critical support for the NOAA mission

### **CIMSS Research Themes:**

- Satellite Meteorology Research and Applications
- Satellite Sensors and Techniques

### **Objective**

Implement the Cloud Cover Layer GOES-R Advanced Baseline Imager (ABI) future capability product into the GOES-R Ground System.

### **Project Overview**

Some years ago, many of the original ABI products were reclassified from “baseline” to “future capability” due to budgetary constraints. In 2014, the NWS Operational Algorithm Team (NOAT) selected five future capability (formerly “option 2”) GOES-R ABI products be transitioned to operations: Cloud Cover Layers, Aerosol Particle Size, Ice Concentration, Ice Age/Thickness, and Ice Motion.

The purpose of this project is to implement the Cloud Cover Layer GOES-R Advanced Baseline Imager (ABI) future capability product into the GOES-R Ground System (GS). In this case the CCL product will report the fraction of cloud at predetermined flight levels. In addition, the Cloud AWG will address other expansions to the CCL products requested by the NOAT. The CCL will also include fraction of cloud comprised of supercooled water and the fraction of cloud that is convective. The accuracy of CCL is inherently tied to the ability to accurately detect and vertically place clouds.



Integrating the Cloud Cover Layers (CCL) product into the GOES-R GS is a three-step process:

1. Development/validation of CCL science code
2. Integration of CCL into the STAR Algorithm Processing Framework (SAPF).
3. Refactoring and integration of the CCL algorithm into the GOES-R Ground System (GS).

The Cloud AWG is responsible for the development of the CCL algorithm and assisting the AIT in the integration into the NOFS. Finally, the Cloud AWG is responsible for the evaluation and validation of the output after the CCL integrated into the NOFS and the GS test and development environments.

### **Milestones with Summary of Accomplishments and Findings**

The CCL project is a collaboration between CIMSS and CIRA. The initial software has been written and tested within the CLAVR-x framework at CIMSS, using the GOES-R cloud algorithms. See Figure 43 for an example image from GOES-13 on April 8, 2016. The software is still in a testing stage, and will soon be evaluated by NOAA/NWS Aviation Weather Center (AWC). In late 2016, the software will be integrated into the SAPF.

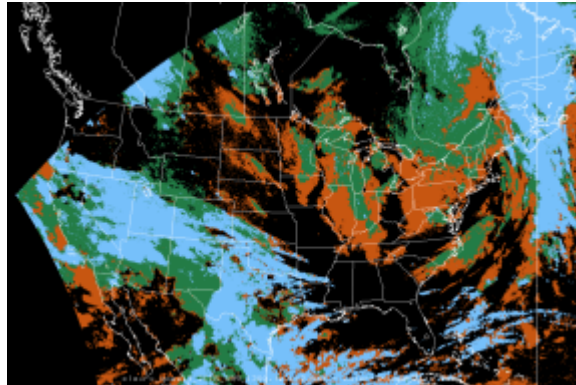

Figure 43. The brown colors represent clouds from the surface to 642 hPa. The green colors are from 642 – 350 hPa, and the blue are clouds from 350 hPa to the top of atmosphere.

## **16. SSEC/CIMSS Cloud Research in Support of the Suomi-NPP and JPSS Programs**

### **16.1 VIIRS Cloud Mask Validation and Tool Development**

**CIMSS Task Leader: Andi Walther**

**CIMSS Support Scientists: Denis Botambekov, Rich Frey, Christine Molling**

**NOAA Collaborator: Andrew Heidinger NOAA/STAR/NESDIS**

**Budget: \$140K**

#### **NOAA Long Term Goals:**

- Weather-Ready Nation

#### **NOAA Strategic Goals:**

- Serve society's needs for weather and water
- Understand climate variability and change to enhance society's ability to plan and respond
- Provide critical support for the NOAA mission



### **CIMSS Research Themes:**

- Satellite Meteorology Research and Applications
- Satellite Sensors and Techniques

### **Objective**

The support of the JPSS VIIRS Cloud Mask (VCM) Cal/Val Team is the main objective of this project.

### **Project Overview**

The JPSS VIIRS Cloud Mask (VCM) Cal/Val Team was created to develop VCM, and using different tools to validate and tune it. Since the launch of the Suomi-NPP in November 2011 with the Visible Infrared Imaging Radiometer Suite (*VIIRS*) on its board the Cal/Val Team has successfully worked on improvements of the VCM performance. This is a collective effort and is coordinated with the other our colleagues from the Air Force Weather Agency (AFWA) in Omaha, Nebraska (Tom Kopp), NOAA STAR JPSS Algorithm Integration Team (AIT) (Walter Wolf). At this moment VCM is in the stage called “Block 2”, and all tuning and code changes are temporarily ceased. However, we are intended to continue to improve the algorithm and apply changes when it would be allowed.

### **Task List**

- *Validation Tool Development*  
Our developed tools allow validating VCM globally and by individual granules.
- *NOAA/NASA Cloud Mask Comparison*  
Using our tools we are able to compare other developed cloud masks (NASA and NOAA) to VCM. These are run at the CIMSS in Madison, Wisconsin (UW). The tools allow creating match-ups between VCM and MODIS (MYD35) cloud masks
- *NOAA Match-ups with CALIOP*  
Data from CALIPSO is considered as “truth”, and match-ups with VCM, or any other cloud mask, allow validating and tuning the algorithm. These tools run at the SSEC in Madison, Wisconsin (UW). The easily identified errors lead to better understanding of cloud detection, and improving of the cloud mask.

### **Milestones with Summary of Accomplishments and Findings**

The new Long-Term Monitoring (LTM) webpage is developed for Cloud Products on the NOAA STAR website ([http://www.star.nesdis.noaa.gov/jpss/EDRs/products\\_clouds.php](http://www.star.nesdis.noaa.gov/jpss/EDRs/products_clouds.php)). It contains daily global ascending node images of Cloud Mask, Cloud Optical Depth, Cloud Top Temperature, and False Color RGB (Figure 44).

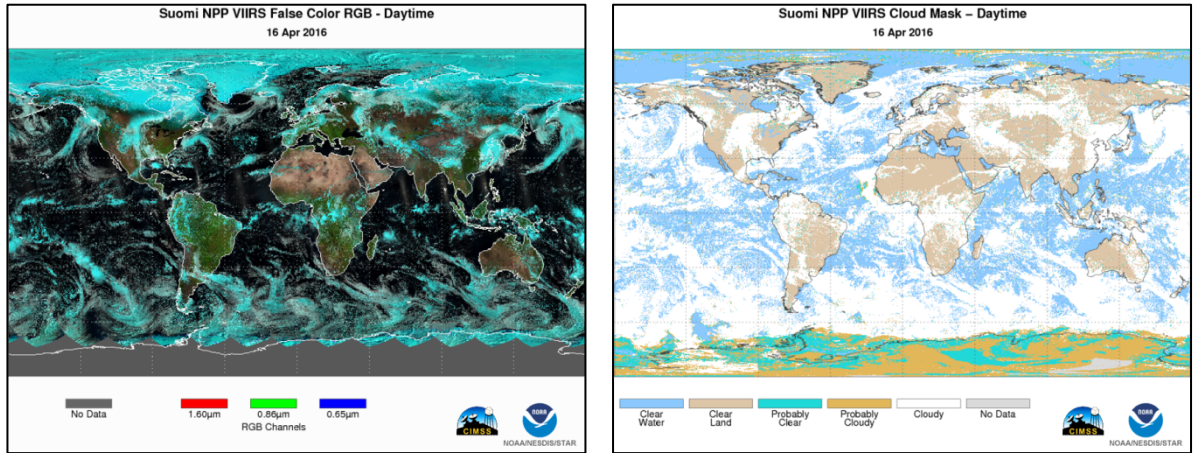

Figure 44. a) Global False Color RGB and b) Global VCM performance, 16 April, 2016, Ascending node.

Developed CALIPSO – VIIRS match-ups collocation tools are periodically used to generate time series, which allow tracking changes in performance as the VCM is tuned (Figure 45). These tools also permit making a statistical comparison with the other cloud mask products.

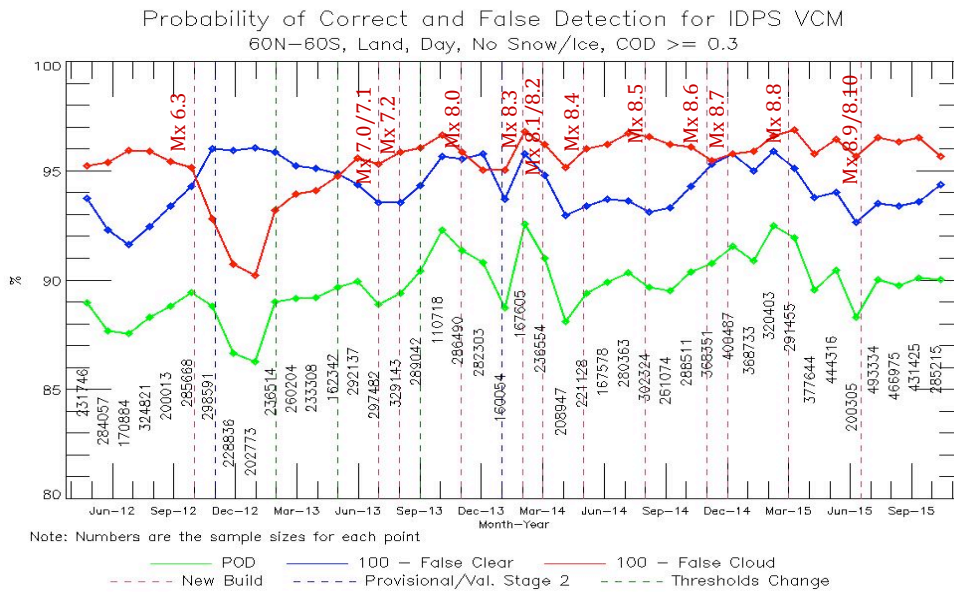

Figure 45. VCM – CALIPSO performance time series over 60N-60S, Land, Day, No Snow/Ice, COD  $\geq$  0.3.

## 16.2 Cloud Phase Algorithm

**CIMSS Task Leaders: Corey Calvert, Jason Brunner**

**NOAA Collaborator: Michael Pavlonis**

**Budget: \$30,000**

### NOAA Strategic Goals:

- Serve society's needs for weather and water



- Understand climate variability and change to enhance society's ability to plan and respond
- Support the nation's commerce with information for safe, efficient and environmentally sound transportation
- Provide critical support for the NOAA mission

#### **CIMSS Research Themes:**

- Satellite Meteorology Research and Applications
- Satellite Sensors and Techniques

#### **Objective**

To develop evaluation data sets, provide processing resources and post launch evaluation for the Visible Infrared Imager Radiometer Suite (VIIRS) cloud phase intermediate product.

#### **Project Overview**

This project supports the Northrop Grumman Aerospace Systems (NGAS) Joint Polar Satellite Systems (NGAS) VIIRS cloud algorithms evaluation of the cloud phase output. This includes providing reprocessing capability (from RDR's) using ADL 3.0 which provides a linux version of the IDPS contractor algorithms which can run locally on the UW-Madison Atmosphere PEATE. We also provide team members access to the IDPS processed cloud phase intermediate product. The reprocessing capability provided allows direct assessment of changes in the cloud EDRs resulting from SDR and calibration and cloud mask tuning post launch. The specific tasks that are conducted for clouds for this effort are; 1) resolving issues and delivering modified code to the Algorithm Integration Team (AIT), and 2) demonstrating the performance of the IDPS cloud phase against other passive and active sensor estimates.

#### **Milestones with Summary of Accomplishments and Findings**

The modified VIIRS cloud phase/type code was successfully delivered to the AIT and the science quality of the product was demonstrated at the Algorithm Readiness Review in December 2015. The VIIRS cloud phase/type product performance meets all science quality requirements. Specifically, the measurement accuracy requirement of 80% correct classification for cloud phase and 60% correct classification for cloud type is successfully met. A validation strategy was developed that derives cloud phase and type products with full global sampling, collocates (in space and time) VIIRS with Cloud-Aerosol Lidar with Orthogonal Polarization (CALIOP), combines CALIOP 1 km and 5 km vertical feature masks and converts into an equivalent passive sensor relevant cloud type using a cloud object based procedure. The validation was performed with and without mixed phase clouds (the ability to identify mixed phase clouds from CALIOP is very limited) and comparative statistics were generated. The VIIRS cloud phase/type algorithm was validated using a large sampling of scenes from 2013 (provided by AIT) and was validated in greater detail using global VIIRS data from November 10, 2012. Validation was performed for the entire dataset but was also separated into various geographical and optical depth categories. Figure 46 shows output from the VIIRS cloud phase/type algorithm (bottom panel) from 03:39 UTC on November 10, 2012. The results match the phase indicated by the false color images well (top two panels).

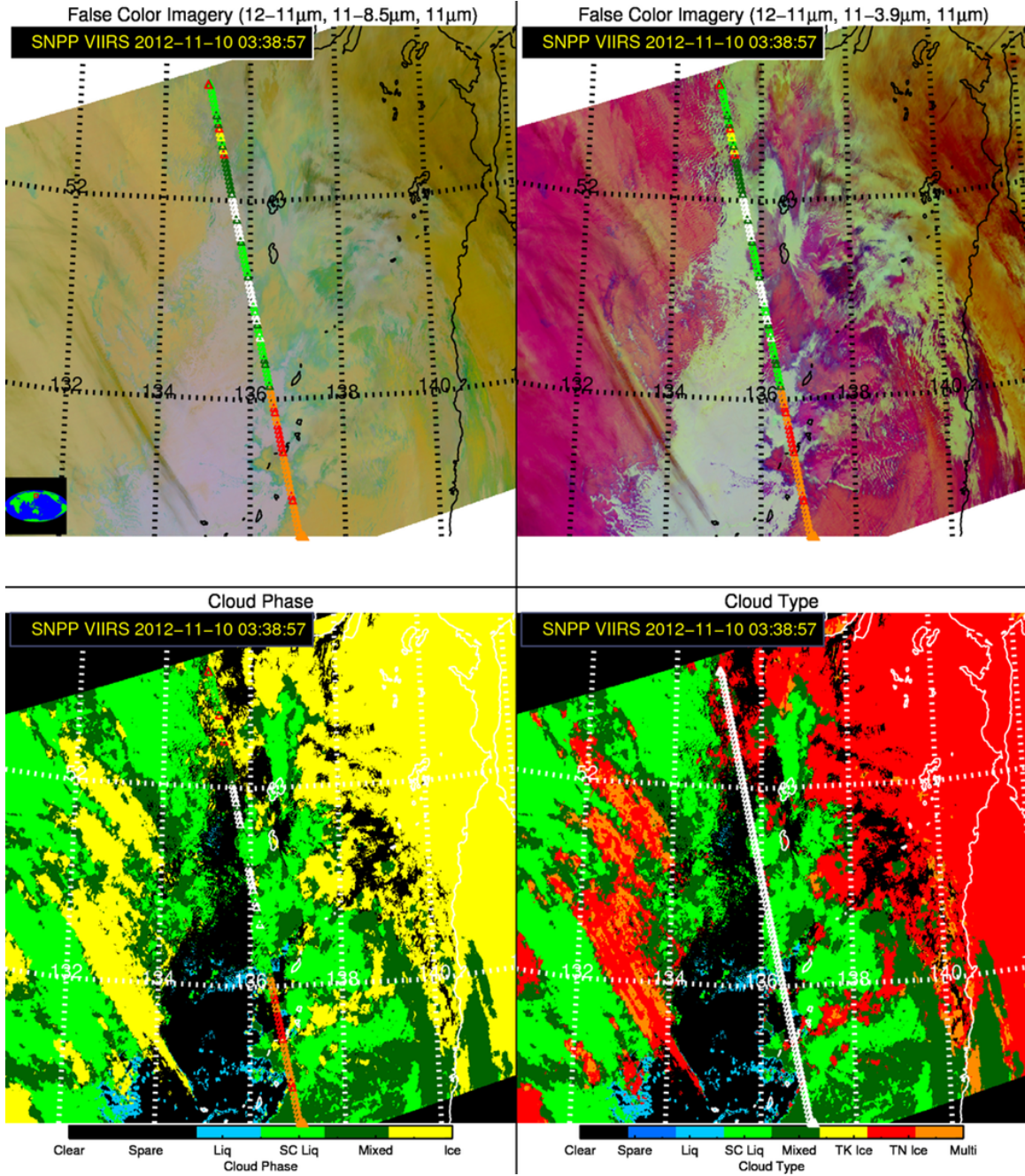

Figure 46. Cloud phase and type output for a VIIRS granule over Asia on November 10, 2012 at 03:39 UTC. False color images are in top two panels and the cloud phase (left) and type (right) are in bottom two panels. CALIPSO ground track is overlaid on each panel.

**16.3 Cloud Optical Properties Algorithm**  
**CIMSS Task Leader: Andi Walther**  
**NOAA Collaborator: Andrew Heidinger**  
**Budget: \$125,000**

**NOAA Long Term Goals:**

- Climate Adaptation and Mitigation



- Weather-Ready Nation

#### **NOAA Strategic Goals:**

- Serve society's needs for weather and water
- Understand climate variability and change to enhance society's ability to plan and respond
- Provide critical support for the NOAA mission

#### **CIMSS Research Themes:**

- Satellite Meteorology Research and Applications
- Satellite Sensors and Techniques

#### **Objective**

This project supports Suomi NPP and JPSS program regarding validation and further developments of cloud optical properties during daytime.

#### **Project Overview**

This project supports the JPSS VIIRS team by providing improved cloud algorithms within the Daytime Cloud Optical and Microphysical Properties (DCOMP) retrieval. We have been working on further retrieval developments and validating against other algorithms and sensors products and against independent data.

DCOMP generates estimates of cloud optical thickness and effective radius and ice/water path during daylight conditions [Walther and Heidinger, 2012]. Descriptive technical details for DCOMP algorithm are provided in the corresponding algorithm technical basis document (ATBD; Walther et al., 2015). The algorithm is based on bi-spectral approach with pre-computed forward operator stored in look-up-tables. DCOMP is performed within an optimal estimation framework, which allows physically based uncertainty propagation. Atmospheric-correction and forward-model parameters, such as surface albedo and gaseous absorber amounts, are obtained from numerical weather prediction reanalysis data and other climate datasets. DCOMP is set up to run on sensors with similar channel settings (e.g., MODIS, SEVIRI, AVHRR, VIIRS and Suomi NPP) and has been successfully exercised on most current meteorological imagers.  
[http://www.star.nesdis.noaa.gov/jpss/EDRs/products\\_clouds.php](http://www.star.nesdis.noaa.gov/jpss/EDRs/products_clouds.php)

#### **Milestones with Summary of Accomplishments and Findings**

The focus in the last period lied in implementation work into NOAA AIT Framework and further evaluation of cloud products. The project successfully implemented the DCOMP retrieval in AIT processing framework and passed Algorithm Readiness Review (ARR). The main focus in the reported period lied in completing and updating corresponding ATBD, and started drafting an OAD.



**Table 3. Validation results overview as shown in ATBD.**

Product	Validation Source	Accuracy	Specs	Precision	Specs
COD Water	MODIS	1.59/0.9%	2. or 20%	4.43/25.7%	2. or 20%
COD Ice	MODIS	1.81/3.6%	3. or 30%	5.02/31.1%	3. or 30%
CPS Water	MODIS	3.03 $\mu$ m	4 $\mu$ m	4.3 $\mu$ m	4 $\mu$ m
CPS Ice	MODIS	5.69 $\mu$ m	10 $\mu$ m	5.23 $\mu$ m	10 $\mu$ m
LWP	MODIS	10g/m <sup>2</sup>	50 g/m <sup>2</sup>	17 g/m <sup>2</sup>	50 g/m <sup>2</sup>
LWP	AMSR-E	17 g/m <sup>2</sup>	50 g/m <sup>2</sup>	47 g/m <sup>2</sup>	50 g/m <sup>2</sup>
IWP	MODIS	44 g/m <sup>2</sup>	100 g/m <sup>2</sup>	65 g/m <sup>2</sup>	100 g/m <sup>2</sup>



**Figure 47. Cover pages of ATBD and OAD for DCOMP retrieval.**

**Publications and Conference Reports**

Walther, Andi, Heidinger, Andrew and William Straka, 2015: DCOMP ATBD.

**References**

A Walther, AK Heidinger 2012: Implementation of the daytime cloud optical and microphysical properties algorithm (DCOMP) in PATMOS-x, Journal of Applied Meteorology and Climatology, 2012.

**16.4 Cloud Top Properties Algorithm**

**CIMSS Task Leader: Yue Li**

**CIMSS Support Scientist: Steve Wanzong**

**NOAA Collaborator: Andrew Heidinger**

**Budget: \$120,000**

**NOAA Long Term Goals:**

- Weather-Ready Nation





### **NOAA Strategic Goals:**

- Serve society's needs for weather and water
- Understand climate variability and change to enhance society's ability to plan and respond
- Provide critical support for the NOAA mission

### **CIMSS Research Themes:**

- Satellite Meteorology Research and Applications
- Satellite Sensors and Techniques

### **Objective**

Retrieve cloud top properties using the existing ACHA algorithm and SuomiNPP observations and evaluate the products, looking for improvements.

### **Project Overview**

The cloud top properties, including cloud top temperature, height and pressure, are the primary output from NOAA's ABI Cloud Height Algorithm (ACHA). The cloud top products are used widely in the scientific community for climate variability and climate change studies, and operationally by the aviation industry. The quality of these products also impact other satellite retrieval algorithms, for instance, the cloud base height and the winds estimations. The objective of this project is to retrieve the cloud top properties building upon the existing ACHA algorithm from the SuomiNPP observations, evaluate them from different ground and space-based observations, and constantly improve the products to meet NOAA requirement and society needs.

### **Milestones with Summary of Accomplishments and Findings**

The retrievals of ice cloud heights are more challenging compared to water phase clouds. One of the causes is due to variations in ice particle shapes and the related scattering properties. ACHA retrievals are highly dependent on the selected ice particle shape and parameterized ice cloud model. In assessing its impact, ten ice cloud microphysical models, including nine theoretically computed and one empirically derived aiming at spectrally consistent particle size, are used to generate one day of cloud top height from MODIS 5km subsampled data and validated against the CALIPSO product. It demonstrates that the new empirical model can effectively reduce ice cloud height bias (Table 4) and we have adopted it in ACHA to replace the previous aggregate column ice model.

Other than the three cloud top properties, ACHA also produces infrared based cloud optical depth and effective particle size, which are day-night consistent and complement the daytime only cloud optical properties, especially for high thin cirrus clouds. Additionally, ACHA derived optical properties are efficient as no radiative transfer computation and/or lookup tables are required. Evaluating the optical products also benefits the cloud top retrievals by comparing on the performance of ice microphysical models. Figure 48 shows that the empirical model is also superior in terms of optical properties.



**Table 4. ACHA cloud top height statistics compared to CALIPSO. One day of MODIS 5km data are employed to run ACHA using ten different ice microphysical models.**

CTH Statistics for Ice Clouds (MODIS 5km Clavr-x vs CALIPSO)										
Ice model	Empirical	Agg-Col	Droxtal	Hol-Col	Solid-Col	Hol-Roset	Solid-Roset	Larg-Agg	Smal-Agg	Plates
Bias(km)	-1.18	-1.40	-1.45	-1.41	-1.43	-1.36	-1.39	-1.37	-1.39	-1.40
Std (km)	1.20	1.17	1.18	1.17	1.18	1.16	1.17	1.16	1.17	1.17
Counts	7064									

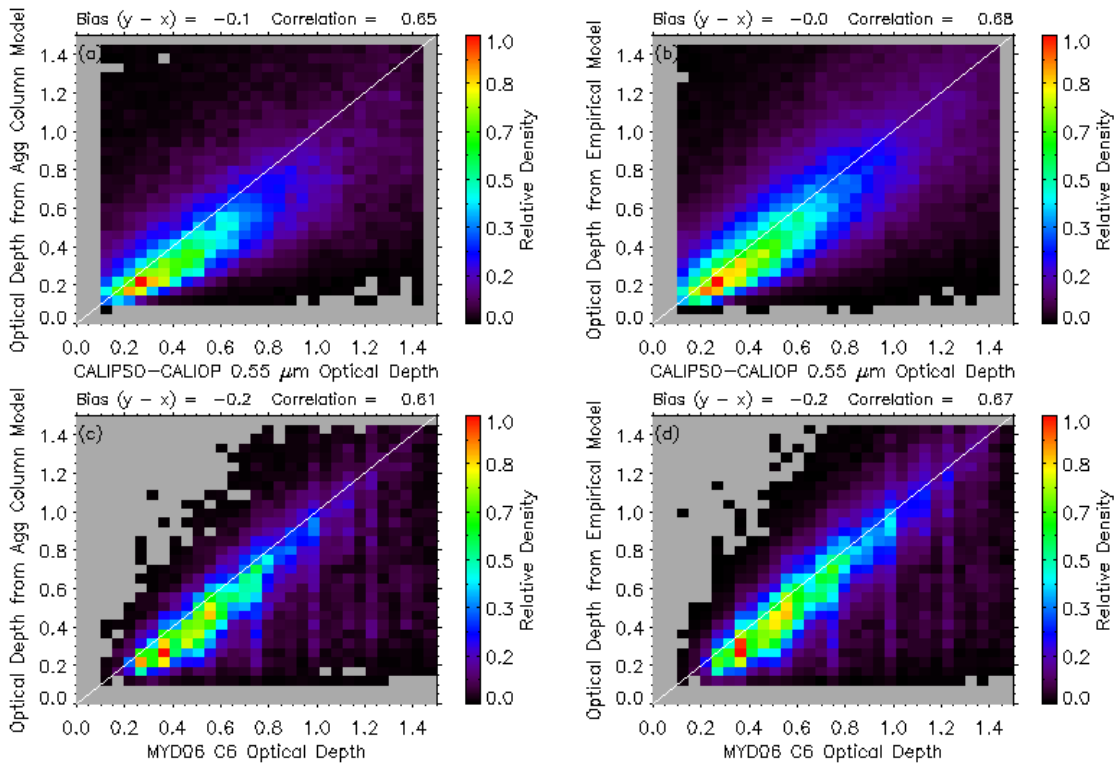

**Figure 48. Comparison of the cloud optical depth retrievals. Upper two panels compare ACHA to CALIPSO using the aggregate column and empirical models, respectively. Bottom two panels compare ACHA to MODIS Collection 6 products using the same models.**

### Publications and Conference Reports

Heidinger, A.K.; Li, Y.; Baum, B.A.; Holz, R.E.; Platnick, S.; Yang, P. Retrieval of Cirrus Cloud Optical Depth under Day and Night Conditions from MODIS Collection 6 Cloud Property Data. *Remote Sens.* 2015, 7, 7257-7271.

### 16.5 CSPP Support

**CIMSS Task Leader: Denis Botambekov**

**CIMSS Support Scientists: Andi Walther, Yue Li**

**NOAA Collaborator: Andrew Heidinger NOAA/STAR/NESDIS**

**Budget: \$30K**



### **NOAA Long Term Goals:**

- Weather-Ready Nation

### **NOAA Strategic Goals:**

- Serve society's needs for weather and water
- Understand climate variability and change to enhance society's ability to plan and respond
- Provide critical support for the NOAA mission

### **CIMSS Research Themes:**

- Satellite Meteorology Research and Applications
- Satellite Sensors and Techniques

### **Objective**

The main objective of this project is to support current CSPP CLAVR-x users, and to enlarge their number.

### **Project Overview**

CSPP CLAVR-x is a free system that allows to process received satellite data in a near real-time to level 2 cloud products. The users all around the world are using this system, and their number is always increasing. Based on the user's feedback algorithms are modified to meet expectations. We closely work with other research group members at CIMSS (Liam Gumley, Kathy Strabala, and Nick Bearson). The new version of CSPP CLAVR-x 2.0 was released in April 2016.

### **Task List**

- *CSPP CLAVR-x Users Support*  
Clear answers and timely responds to all CSPP CLAVR-x users' questions are important for keeping users satisfied with a quality of cloud products. Outreach other possible users.
- *CSPP CLAVR-x Algorithms Improvement*  
Algorithms code improving is an essential task based on the users' feedback (bug fixing, new algorithms developing, existing algorithms improvement). Prepare new releases of CSPP CLAVR-x that would satisfy users' needs.

### **Milestones with Summary of Accomplishments and Findings**

Participation at the 6th Asia/Oceania Meteorological Satellite User's Conference in Tokyo, Japan allowed meeting with the current CSPP CLAVR-x users, and spreading the word about this system to others. In 2015 the Japan Meteorological Agency (JMA) has launched the new geostationary satellite – Himawari-8, with the Advanced Himawari Imager (AHI) on its board. The similar instrument Advanced Baseline Imager (ABI) will be launched later in 2016 on board of the GOES-R. CSPP CLAVR-x among many others supports these sensors as well. The representatives from Asian and Oceania meteorological offices expressed their interest in using CSPP CLAVR-x.

The members of Siberian Regional Center (Novosibirsk, Russian Federation) of “Hydro-Meteorology from Space, Science-Research Center – PLANETA” conducted an independent research of CSPP CLAVR-x results ([http://www.repod.ru/cgi-bin/read\\_news.pl?ID=17](http://www.repod.ru/cgi-bin/read_news.pl?ID=17)). For this research they have compared the Cloud Type, Cloud Top Temperature (CTT), and Cloud Top Height (CTH) from CSPP CLAVR-x (AVHRR: NOAA-18, NOAA-19, and MetOp-B) with the Doppler Weather Radar located in Barabinsk, Russian Federation, and Flight Weather Reports

from the flying planes in that area (Figure 49). In total they analyzed 83 days of data from June 1<sup>st</sup> to September 14<sup>th</sup>, 2015. Overall, the total agreement between the CSPP CLAVR-x results and Weather Radar was in 79.5% of the cases, the total disagreement in 0.9%. The cloud type agreed in 95.9% of the cases, while CTH in 82.7%.

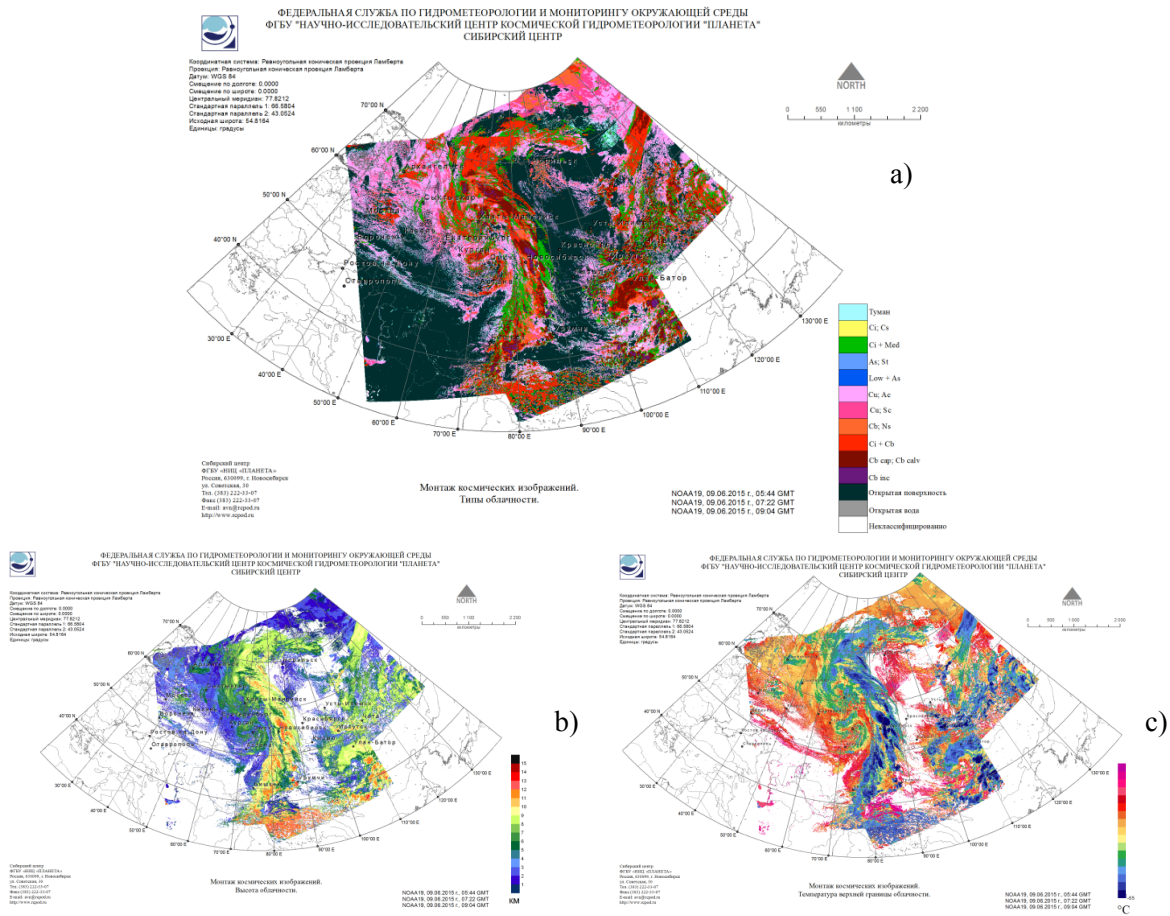

Figure 49. a) Cloud Type; b) Cloud Top Temperature (CTT); c) Cloud Top Height (CTH), CSPP CLAVR-x, NOAA19, June 09, 2015, 09:04UTC.

The new release of CSPP CLAVR-x 2.0 was announced in April, 2016. It includes improvements to the previous release algorithms, new added algorithms (for example Cloud Base Height), increase of the code structure effectiveness and processing stability.

### Publications and Conference Reports

Bearson N. "CSPP / CLAVR-x". The CSPP/IMAPP User's Group Meeting in Darmstadt, Germany, April 14-16, 2015.

Heidinger A. "New Features in the Upcoming CLAVR-x". The CSPP/IMAPP User's Group Meeting in Darmstadt, Germany, April 14-16, 2015.

Botambekov D. "Cloud Products From CSPP-CLAVR-x". The Sixth Asia/Oceania Meteorological Satellite Users' Conference, 9 - 14 November, 2015, Tokyo, Japan.



Planning to participate at the 1st Workshop of the International Cloud Working Group (ICWG), 17 - 20 May 2016, Lille, France.

Planning to participate at the Joint AMS-7th Asia-Oceania Satellite Meteorology Users Conference, October/November 2016, South Korea.

## **16.6 VIIRS Aerosol Evaluation Using Satellite Observations**

**CIMSS Task Leader: Robert Holz**

**NOAA Collaborator: Andrew Heidinger**

**Budget: \$75,000**

### **NOAA Long Term Goals**

- Climate Adaptation and Mitigation
- Weather-Ready Nation

### **NOAA Strategic Goals**

- Serve society's needs for weather and water
- Understand climate variability and change to enhance society's ability to plan and respond

### **CIMSS Research Themes**

- Satellite Meteorology Research and Applications

### **Objective**

This project supports the NPP-VIIRS cloud and aerosol evaluation as part of the Joint Polar Satellite System (JPSS). The VIIRS cloud algorithms were developed by Northrop Grumman Aerospace Systems (NGAS). Before launch, the performance of these algorithms (both aerosol and clouds) had not been well characterized due to a lack of pre-launch proxy data with only small (24 granule) proxy dataset available for evaluation.

### **Project Overview**

The successful launch of Suomi NPP provides for the first time the ability to evaluate the NGAS algorithms using real observations. Using the extensive tools and processing capabilities developed as part of our current support for JPSS, we provide satellite inter comparisons with VIIRS with a focus on NASA A-Train cloud products.

### **Milestones with Summary of Accomplishments and Findings**

We completed a significant milestone this year with the completion of the JPSS cloud assessment report which was delivered to the JPSS program. This project supported both the evaluation and report preparation. Our work has identified and corrected two issues during this first year. First, the team identified an error in the COP lookup table interpolation. Second, the team developed an improvement to the height assessment of low level clouds that will impact the accuracy performance. The second fix has not been implemented into the IDPS yet.

Even with these improvements, the team has found major issues remain with the cloud products. Artifacts that remain in the products jeopardize their utility until solutions can be found and implemented. For these reasons, we do not feel these products are useable by NOAA customers at this time. The major issues that have been identified are:



- Low convergence rates for cloud retrievals. For example, roughly 60% of cloudy pixels have IP COP results classified as successful;
- Cloud top heights are severely underestimated in general for most transmissive high-level clouds (i.e., cirrus), especially in the Tropics, but can also exhibit a tendency for severe over-estimation at times when solutions appear to follow the Tropopause Level;
- Though this issue will be addressed in a future IDPS release, low-level CTH are too high, often by as much as 2-3 km. This is most evident over oceans in areas of widespread stratocumulus decks;
- The inference of cloud base height is challenging for a passive VIS/IR sensor such as VIIRS. The cloud base height product depends critically the performance of the CTH and cloud phase, among other things, as input. Comparisons with the active radar of CloudSat indicate that there is very limited accuracy obtained at this time. The product demonstrates less accuracy for thin cirrus than water cloud layers;
- For most of the first year, COP exhibited erroneous distributions of optical thickness and particle size due to problems associated with the look-up tables (LUTs). Earlier analyses led to an updated LUT being developed for IDPS;
- With the updated LUT that went into IDPS operations, the COP does not return a valid result for about a third of the cloudy pixels, a much higher number than other operational algorithms;
- The accuracy specification is met for some of the COP parameters for some phases. The precision specification is generally not met;
- With the updated LUT that went into IDPS operations on 5 September, 2012, there are still indications of LUT-related issues. The COP comparisons relative to NOAA and NASA results indicate a large scan angle dependence that hints at continued flaws in the COP LUTs. Discontinuities in the distributions of the latest COP results also indicate remaining issues with the COP convergence method;
- The team has found difficulty in using the quality flags and has found them to be generally inadequate. The quality flags are designed for analysis to determine specification compliance. Their use by the community will be problematic. The team has made suggestions for additions to the COP quality flags to address these issues; and
- Taken together, some issues such as QA flags could be resolved given sufficient resources. However, the COP and CTP/CTH/CTT algorithms suffer from a lack of operational maturity. The ADL may lack the necessary ancillary datasets required to help improve products over land surfaces.

We are currently working to address some of the issues with NGAS and continue provide recommendations to the JPSS project.

## **16.7 McIDAS Support for VIIRS Imagery and Data Analysis**

**Task Leaders Tom Rink, Tommy Jasmin**

**NOAA Collaborator: Don Hillger (RAMMB/CIRA)**

**Budget: \$20,935**

### **NOAA Long Term Goals:**

- Climate Adaptation and Mitigation
- Weather-Ready Nation

### **NOAA Strategic Goals:**

- Serve society's needs for weather and water



- Understand climate variability and change to enhance society's ability to plan and respond
- Provide critical support for the NOAA mission

#### **CIMSS Research Themes:**

- Satellite Meteorology Research and Applications
- Satellite Sensors and Techniques
- Environmental Models and Data Assimilation
- Education and Outreach

#### **Project Overview**

SSEC/CIMSS has added support for visualization and analysis of Suomi NPP data in McIDAS-V. Code has been developed to support the VIIRS, CrIS, and ATMS instruments. A user interface was introduced allowing aggregation of multiple consecutive granules into a single data selection, greatly improving ease of use.

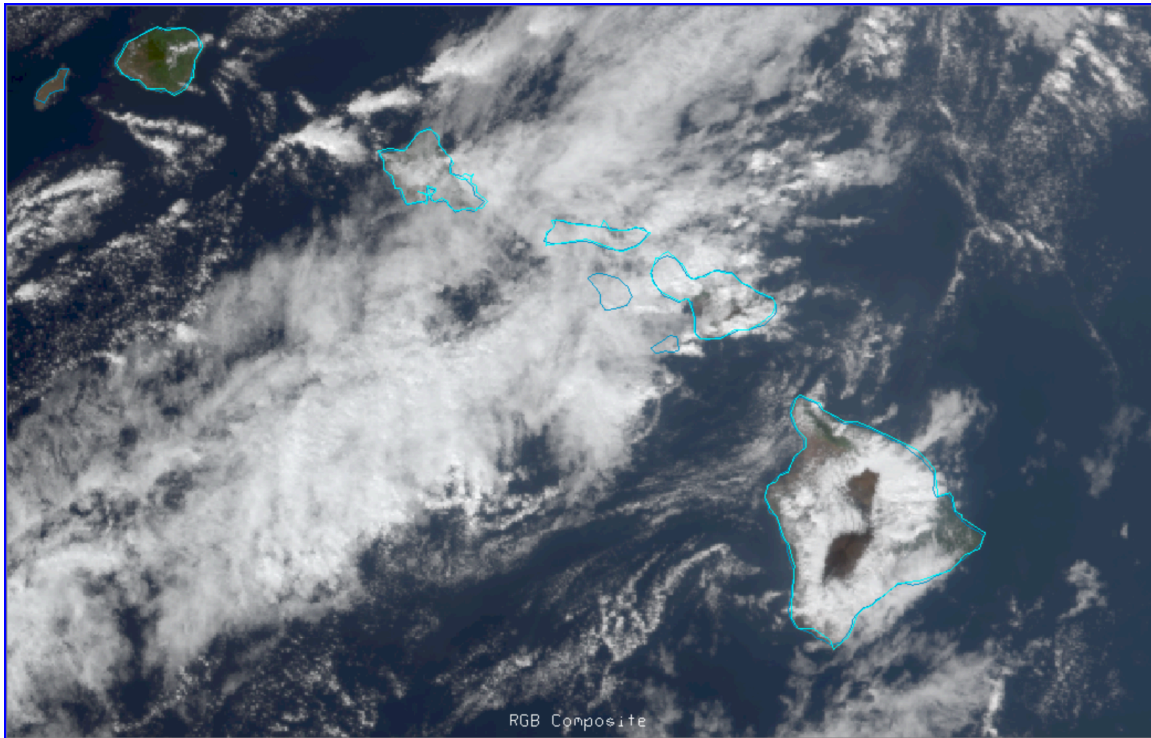

**Figure 50.** VIIRS True Color Image from NASA L1B data rendered in McIDAS-V.

In 2015 it was announced that the SSEC Atmosphere SIPS (<http://sips.ssec.wisc.edu>) would be transitioning from ingesting, archiving, and providing access to NOAA Suomi NPP products, to providing only NASA VIIRS L1B products. As a result the primary focus of this task shifted to developing support for the NASA VIIRS data in McIDAS-V. This code has been developed and is available in the McIDAS-V nightly builds, based on preliminary, Release Candidate 2 data from SIPS. The primary VIIRS-related McIDAS-V goals for 2016 will extensive testing and completion of support for visualization and analysis of NASA L1B products, and resolving outstanding high priority feature requests and bug reports in time for the next stable McIDAS-V release, version 1.6.



## Additional Planned Development for 2016

- *Continue scripting development to facilitate user-driven derived product creation and background processing.*  
Several users, including members of the NESDIS/StAR VIIRS Imagery Team, have expressed a need to utilize McIDAS-V capabilities with VIIRS data in a background environment. For example, to access data, run processing algorithms, and create output products. SSEC will provide this functionality via the Jython scripting interface, which has been under active development the past three years.
- *Expand on I/O conversion options.*  
At present, users can load Suomi NPP data and write KMZ (which can be loaded in for example Google Earth). Users have expressed interest in being able to write Satellite-CF compliant NetCDF files, and GeoTIFF files. As standards for satellite data are only now emerging, swath data can be gridded and output using current CF standards. Explore using this process for volume visualization of CrIS retrievals.
- *Handle visualization of low-Earth orbit (granule-based) data crossing the 180-degree longitude line.*  
Currently, McIDAS-V has issues with swath data that straddles the International Date Line. The problem typically manifests as small pieces of missing data in the display for these granules, and is a serious deficiency for McIDAS-V when working with data near the poles.

## 17. SSEC/CIMSS Research Tasks in Support of the Suomi NPP and Joint Polar Satellite System (JPSS) Sensor Data Records

### 17.1 A Broad Scope of Calibration/Validation and Independent Verification and Validation Activities in Support of JPSS, with Emphasis on CrIS SDRs

**CIMSS Task Leader: Dave Tobin**

**CIMSS Support Scientists: Joe Taylor, Robert Knuteson, Lori Borg, Dan DeSlover, Graeme Martin, Aronne Merrelli, Tom Greenwald, HankRevercomb**

**NOAA Collaborator: Yong Han**

**Budget: \$695,327**

#### **NOAA Long Term Goals:**

- Weather-Ready Nation

#### **NOAA Strategic Goals:**

- Serve society's needs for weather and water
- Understand climate variability and change to enhance society's ability to plan and respond
- Provide critical support for the NOAA mission

#### **CIMSS Research Themes:**

- Satellite Meteorology Research and Applications
- Satellite Sensors and Techniques

#### **Objective**

One of many objectives of this work is to provide input on the tasks needed for the post-launch JPSS-1 CrIS Cal/Val plan.





## Project Overview

For the past period of performance, efforts of this project have focused on four main areas: 1) Support of CrIS SDR related reviews and meetings, 2) continued Cal/Val analyses of the Suomi-NPP CrIS SDR data, 3) CrIS SDR algorithm assessment and refinement for Suomi-NPP and JPSS-1, and 4) Analysis of the JPSS-1 TVAC CrIS test data.

## Milestones with Summary of Accomplishments and Findings

We have had numerous accomplishments and findings associates with the goals of this project.

Titles of various topics are listed below:

1. JPSS-1 CrIS TVAC: Imaginary Radiance and Phase Residual Analysis,
2. JPSS-1 CrIS TVAC: Gas Cell Spectral Interfov Analysis,
3. CrIS FIR Filter Normalization and the Nonlinearity DC level model,
4. CrIS FSR to LSR interferogram truncation,
5. Pre-launch JPSS1 CrIS Radiometric Uncertainty estimates for ECT view data,
6. CrIS Radiometric Uncertainty and Uncertainties in the predicted ECT view radiances,
7. Suomi-NPP LW FOV5 Cold Scene Anomaly,
8. CrIS FIR Normalization and Convolution Correction,
9. Assessment of Candidate Calibration Algorithms using Clear Sky Obs-Calcs,
10. Comparisons of S-NPP and JPSS-1 Responsivities and “True Ringing,”
11. FIR Filtering and Aliasing,
12. CrIS/VIIRS comparisons,
13. Inputs to JPSS1 CrIS Cal/Val Plan,
14. CrIS Polarization and Analysis of CrIS Pitch Maneuver Data,
15. Suomi-NPP CrIS Midwave  $a_2$  adjustments,
16. Hyperspectral Radiance Trend Investigations,
17. XSR Phase and Truncation study,
18. FIR Convolution Correction applied to S-NPP XSR Earth view data,
19. Implications of NIST TXR results on ECT and ST characterization, and
20. UW CCAST mods/status.

Due to space limitations the details of these studies are not provided here. As one example, our efforts to help in the creation of the JPSS-1 CrIS post-launch Cal/Val plan are briefly described here.

In June 2015 we provided input to the JPSS1 Cal/Val plan. This included both pre- and post-launch tasks, listed below. For each task, a summary slide and a document describing the goals, approach, and expected results were provided.

### Pre-launch tasks:

1. Gas Cell Data Analysis
2. Radiometric Nonlinearity Analyses
3. Pre-launch Radiometric Uncertainty estimates

### Post-launch tasks:

1. Internal Consistency Checks on Radiometric Calibration
2. Internal Consistency checks on spectral calibration, self-apodization corrections, and resampling
3. Radiometric Nonlinearity Evaluation and Refinement
4. Comparisons of S-NPP and JPSS-1 CrIS Spectral Radiances
5. SDR evaluations using SNO comparisons with IASI and AIRS



6. CrIS/VIIRS Radiance Comparisons
7. Clear Sky Observations and Forward Calculations from NWP Analyses to Support Cal/Val Activities
8. Spectral Ringing Evaluation and Refinement
9. Polarization Characterization
10. Assess Spectral Artifacts in Earth View Spectra via Principal Component Analysis
11. Estimation of In-orbit Radiometric Uncertainty

We then participated in review of the draft post-launch J1 Cal/Val plan, including participation in the 9 December 2015 telecon. Among other contributions, we provided specific recommendations on details of the early space craft and early activation schedule, space craft maneuvers for polarization characterization, and diagnostic mode data collections.

### **Publications and Conference Reports**

*Imaginary Radiance and Phase Residuals, J1 TVAC, CrIS SDR telecon, 27 January 2015.*

*J1 CrIS TVAC Gas Cell Data Spectral Inter-FOV Analysis: Evaluation of Exelis Draft ILS Parameters, CrIS SDR telecon, 25 February 2015.*

*FIR Filter Normalization and Nonlinearity DC Level Model, CrIS SDR telecon, 25 February 2015.*

Tobin, D. C., H. Revercomb, R. Knuteson, J. Taylor, L. Borg, D. H. DeSlover, G. Martin, A. Merrelli, and T. Greenwald Suomi-NPP Cross-track Infrared Sounder (CrIS): Radiometric Calibration and Validation, *Proceedings from the 95th American Meteorological Society Annual Meeting, Joint session of the 11th Annual Symposium on New Generation Operational Environmental Satellite Systems and the 20th Conference on Satellite Meteorology and Oceanography*, Phoenix, AZ, January 2015.

“Investigation of CrIS FSR SW band filtering/decimation and truncation”,  
*uw\_sw\_band\_study\_20150415.pptx, presented at 4/15 SDR telecon.*

“CrIS LW FOV5 Cold Scene Anomaly”,  
*Knuteson\_LW\_FOV5\_coldScene\_anomaly\_29Apr2015.pdf, presented at 4/29 SDR telecon.*

“Obs – Calc results from NOAA FSR test data”, *UW\_FSR\_obs\_calc\_results\_2015\_04\_29.pdf, presented at 4/29 SDR telecon.*

“Comparison of S-NPP and JPSS-1 Responsivities and differences in “True Ringing”,  
*j1\_and\_snpp\_responsivities.pptx, presented at 5/27 SDR telecon.*

“Preliminary results from the 2015 S-NPP Aircraft Campaign”,  
*SHIS\_Greenland2015\_20150527.pptx, presented at 6/10 SDR telecon.*

“S-NPP LW FOV5 Cold Scene Anomaly”, Dave Tobin, 05 August 2015 CrIS SDR telecon presentation, *UW\_LW\_FOV5\_Cold\_Scene\_Anomaly\_20150805.pptx*

“CrIS Calibration Bias due to Polarization”, Joe Taylor, 16 September 2015 CrIS SDR telecon presentation, *UW\_CrIS\_Polarization\_2015-09-15.pdf*



“Adjustment to S-NPP MW FOV7 quadratic nonlinearity coefficient”, Dave Tobin and Jon Gero, 16 September 2015 CrIS SDR telecon presentation, uw\_SNPP\_MW7\_a2\_adjustment\_20150918.pptx

“J1 CrIS Radiometric Calibration”, Dave Tobin, 2015 JPSS Science Team Annual Meeting, College Park, MD, 26 August 2015.

“Detecting Climate Trends with High Spectral Resolution Infrared Satellite Radiances”, Daniel DeSlover, 2015 EUMETSAT Meteorological Satellite Conference, September 2015.

“JPSS-1 CrIS” Pre-launch Characterization of the Radiometric Calibration”, David Tobin, 15 EUMETSAT Meteorological Satellite Conference, September 2015.

“UW Assessment of CrIS FIR Filter Requirements”, Robert Knuteson, 14 Oct 2015 CrIS SDR telecon presentation.

“Adjustment to S-NPP Midwave band quadratic nonlinearity coefficients (Update to 16 Sept 2015 presentation)”, David Tobin, 14 Oct 2015 CrIS SDR telecon presentation.

“Phases of NSR, FSR, XSR Complex Spectra and Truncation to NSR”, David Tobin, 18 November 2015 CrIS SDR telecon presentation.

“FIR Convolution Correction: First look at XSR data”, Robert Knuteson, 18 November 2015 CrIS SDR telecon presentation.

“FIR Aliasing Update: NPP Earth Diagnostic Mode”, Robert Knuteson, 01 December 2015 CrIS SDR telecon presentation.

“UW-SSEC Polarization Analysis of CrIS Pitch Maneuver Data”, Joe Taylor, 03 February 2016 CrIS SDR telecon presentation.

“Recent Insights into the CrIS FOV5 anomaly: CrIS/IASI SNOs”, Robert Knuteson, 17 February 2016 CrIS SDR telecon presentation.

“CrIS FOV-5 Artifact: Beamsplitter Channeling as a Possible Mechanism”, 16 March 2016 CrIS SDR telecon presentation.

**17.2 VIIRS SDR Calibration/Validation**  
**CIMSS Task Leader: Chris Moeller**  
**CIMSS Support Scientist: Dan LaPorte**  
**NOAA Collaborator: Changyong Cao**  
**Budget: \$102,150**

**NOAA Long Term Goals:**

- Climate Adaptation and Mitigation

**NOAA Strategic Goals:**

- Understand climate variability and change to enhance society’s ability to plan and respond



## **CIMSS Research Themes:**

- Satellite Sensors and Techniques

### **Objective**

This task strives to establish and maintain VIIRS instrument performance for all VIIRS sensors, utilizing pre-launch test characterization with on-orbit evaluation to optimize accuracy and precision of the SDR product.

### **Project Overview**

This task includes participation on the VIIRS SDR Team, activities associated with SNPP VIIRS on-orbit performance, and JPSS-1 pre-launch performance characterization in preparation for the launch of JPSS-1.

### ***SNPP VIIRS SDR Performance***

This subtask supports the ongoing application of a subset of VIIRS Cal/Val task tools at UW-Madison for SDR performance monitoring and review, including contributing to investigations of known and revealed on-orbit performance issues and adjustments to the SDR calibration algorithm either in response to performance anomalies or through improved understanding of instrument performance (e.g. bias corrections). Along with satellite-satellite radiometric intercomparisons, this subtask also includes radiometric validation using aircraft.

### ***JPSS-1 VIIRS Pre-Launch Test Program Performance Characterization***

Through participation in the JPSS-1 Pre-TVAC, TVAC, and Post-TVAC phases of the pre-launch test program, UW-Madison has gained deep knowledge and insight into the test program data quality. This expertise is applied to performance analysis and LUT generation to support the JPSS-1 at-launch SDR algorithm readiness. This subtask has its primary focus on the JPSS-1 spectral characterization but also includes other performance elements such as response vs scan, radiometric calibration, and crosstalk, all in support of the on-orbit SDR algorithm.

### ***Support STAR and SDR Team Meetings and Activities***

The VIIRS SDR Team meets to discuss timely matters of SNPP and JPSS-1 VIIRS and to plan path forward. Under this subtask, UW-Madison is continuing participation on the VIIRS SDR Team, providing analyses on VIIRS SDR performance and participating in the review of all VIIRS performance issues.

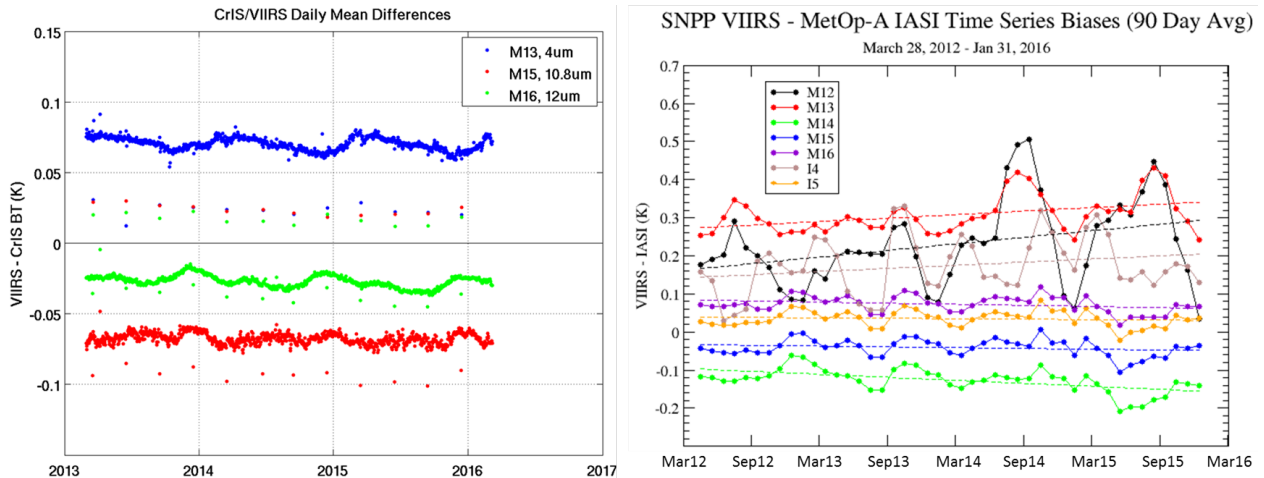

Figure 51. Time series of SNPP VIIRS – CrIS daily comparisons (left) and VIIRS SNO comparisons to MetOp-A IASI (right).

## Milestones with Summary of Accomplishments and Findings

### SNPP VIIRS On-Orbit Performance Evaluation

Wisconsin has continued activities begun under Cal/Val tasks RAD-01, RAD-04, RAD-12(A,B) and RAD-21. These activities are adding to the body of documentation of SNPP VIIRS on-orbit performance. These tasks and data vigilance have supported investigations into the following highlighted performance aspects:

- Daily SNPP VIIRS-CrIS spectral radiance comparisons for the last 3 years on-orbit (Figure 51, left panel) continue to reveal excellent calibration performance for bands M13, M15, M16 and I5 with globally averaged differences within +/- 0.1 K for typical scenes. Existing scene temperature dependence remains within specification at all scene temperatures for these bands. Radiometric trends appear to remain very small, < 5 mK/year. The HAM RVS also continues to show good performance as bands M13, M15, M16, and I5 all exhibit scan angle dependence < 0.1 K.
- VIIRS-IASI SNO comparisons with MetOp-A and MetOp-B have been updated through January 2016, increasing the data record to about 4 years (MetOp-A). Biases in MWIR bands (M12, M13, I4) continue to be elevated at very cold scene temperatures, exceeding 1 K for these bands for scene temperatures below 220K. LWIR bands continue to perform very steadily with minor (~0.1 K) bias dependence in the 200 – 275 K scene temperature range of the SNOs.
- Time series data suggest that trends in VIIRS-IASI biases (Figure 51, right panel) remain very small (<10 mK/year) in LWIR bands for the range of scene temperatures (200-280K) in high latitude SNOs. For band I5, which has shown a measureable ~1% drift in its F factor over the lifetime of the mission, this result mitigates concern that the F factor drift is biasing the I5 brightness temperatures. MWIR band trends are larger (up to 30 mK/year for M12); however, seasonal variation and the cold scene temperature bias dependence mentioned above may be elevating the trends since the data record falls short of completing the 4<sup>th</sup> year. This element warrants vigilance going forward.

### JPSS-1 VIIRS Pre-launch Performance Characterization

The effort on JPSS-1 VIIRS has focused primarily on spectral characterization leading to a Version 2 RSR product releases to the VIIRS user community.

- Using a forward model approach, JPSS-1 VIIRS M13 band average and detector RSR have been corrected for the influence of CO<sub>2</sub> in the ambient environment during the



- measurements. The model-based correction removed deficits in response due to the CO<sub>2</sub> attenuation of the source signal.
- The analysis of JPSS-1 VIIRS band average RSR using TSIRCUS measurements was completed for all VisNIR bands (M1-M7, I1, I2, DNBLGS) that were measured. The updated band average RSR were merged with the June 2015 Version 1 release of the SpMA-based JPSS-1 VIIRS band average RSR to form a fused RSR for these bands.
  - The Version 2 RSR have been released and along with supporting documentation are available on the password protected NASA eRooms at [https://jpss-erooms.ndc.nasa.gov/eRoom/JPSSInstruments/VIIRSF2\\_JPSS1/0\\_38007](https://jpss-erooms.ndc.nasa.gov/eRoom/JPSSInstruments/VIIRSF2_JPSS1/0_38007). The Version 2 RSR consist of fused RSR for VisNIR bands plus the CO<sub>2</sub>-corrected M13 RSR. Version 2 RSR for bands that have not been updated (M8-M12, M14-M16, I3-I5, DNBMGS) are taken from Version 1 RSR. The Version 2 RSR, consisting of band average and detector RSR for all VIIRS bands, replace the June 2015 Version 1 RSR.
  - The Version 2 JPSS-1 VIIRS RSR have been used to update the JPSS-1 VIIRS RSR LUT to “at-launch” status.

### **Publications and Conference Reports**

G. Moy, F. DeLuccia, and C. Moeller, “Modification of VIIRS Sensor Data Record Operational Code for Consistency of Data Product Limits”. IGARSS 2015, July 26-31, 2015, Milan, Italy.

Moeller, C., T. Schwarting, J. McIntire, and D. Moyer, “JPSS-1 VIIRS Pre-launch Spectral Characterization and Performance”, SPIE Vol. 9607, 960711S, doi:10.1117/12.2188658, (2015).

Moeller, C., T. Schwarting, J. McIntire, and D. Moyer, “JPSS-1 VIIRS Version 2 At-launch Relative Spectral Response Characterization”, submitted for presentation at the EOS XXI conference of the August 2016 SPIE annual meeting in San Diego, CA.

Robert A. Barnes, Steven W. Brown, Keith R. Lykke, Bruce Guenther, James J. Butler, Thomas Schwarting, Kevin Turpie, David Moyer, Frank DeLuccia, and Christopher Moeller, "Comparison of two methodologies for calibrating satellite instruments in the visible and near-infrared," Appl. Opt. **54**, 10376-10396 (2015).

Chris Moeller attended the STAR JPSS-1 August 2015 Annual Science Team meeting in College Park, MD and presented a talk titled “J1 VIIRS Spectral Characterization and Performance.”

## **18. SSEC/CIMSS Research Tasks in Support of Suomi NPP and the Joint Polar Satellite System (JPSS) Sounding and Cryosphere Environmental Data Records (EDR)**

### **18.1 CrIMSS EDR Cal/Val: ARM Site Support 2015**

**CIMSS Task Leader: Lori Borg**

**CIMSS Support Scientists: David Tobin, Michelle Feltz**

**NOAA Collaborators: Tony Reale, Quanhua (Mark) Liu, Nicholas Nalli**

**Budget: \$75,000**

#### **NOAA Long Term Goals:**

- Climate Adaptation and Mitigation
- Weather-Ready Nation



### **NOAA Strategic Goals:**

- Serve society's needs for weather and water
- Understand climate variability and change to enhance society's ability to plan and respond
- Provide critical support for the NOAA mission

### **CIMSS Research Themes:**

- Satellite Meteorology Research and Applications
- Satellite Sensors and Techniques

### **Objective**

CrIMSS temperature and water vapor retrieval validation using ARM site atmospheric state best estimates.

### **Project Overview**

The goal of this task is to prepare for and to conduct efforts for the critical validation of S-NPP CrIMSS atmospheric temperature and water vapor retrieved profiles and observed infrared radiances. Given the high accuracy retrieval goals of CrIMSS (1 degree Kelvin accuracy for 1 km layers in the troposphere and moisture profiles accurate to 15 percent for 2 km layers) careful and detailed validation using accurate and on-going validation data is required. The Atmospheric Radiation Measurement (ARM) program field sites provide such data. In this arrangement, radiosondes have been launched coincident with the S-NPP satellite overpasses of the ARM sites located at Eastern North Atlantic (ENA), North Slope of Alaska (NSA), Southern Great Plains (SGP), and Tropical West Pacific at Manus (TWP). Combined with other ARM data, an assessment of the radiosonde data quality is performed and post-processing corrections are applied producing an ARM site best estimate (BE) product. This validation data set is a well-characterized ensemble of temperature and water vapor profiles, which is essential for assessment of the satellite products. Previously for AIRS and IASI, best estimates (BE) of the atmospheric state at the satellite overpass times were produced via a similar collaborative effort between NASA and ARM. This work was a fundamental, integral, and cost-effective part of the EOS validation effort and provided critical accuracy assessments of the AIRS temperature and water vapor soundings. Further science justification and details of the approach for this effort are described in detail in Tobin et al., 2006. It is hoped that this effort will be repeated throughout or periodically during the S-NPP mission.

### **Milestones with Summary of Accomplishments and Findings**

This effort has involved the continuing coordination of radiosonde launches at the Eastern North Atlantic (ENA), North Slope Alaska (NSA), and Southern Great Plains (SGP) ARM sites coincident with overpasses of the S-NPP satellite. Phase-3 of this effort, which began in February 2015, was concluded in September 2015, during which a total of 38/46/53 overpasses were targeted at the ENA/NSA/SGP sites respectively. Phase-4 of this effort began in October 2015 and is ongoing with the expectation to target approximately 90 overpasses at each site. See Figure 52 for additional information on the radiosonde launch efforts during each phase. In addition to the radiosonde launch coordinating activities, assessments of the radiosonde quality, creation of BEs of the atmospheric state, and comparisons with NUCAPS retrievals have been underway.

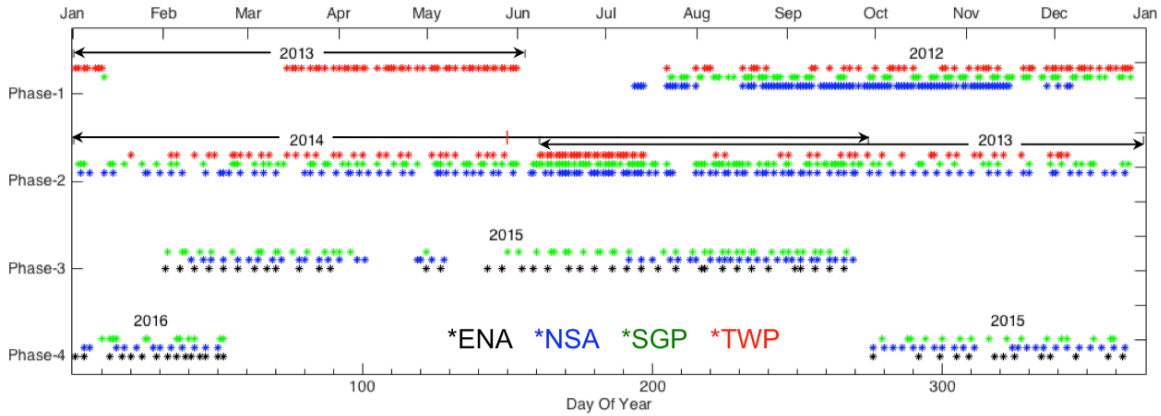

Figure 52. CrIMSS EDR radiosonde launch efforts July 2012 – March 2016.

In an effort to better understand upper-tropospheric and lower-stratospheric temperatures, a preliminary evaluation of NUCAPS temperature retrievals was made using the ARM BE profiles and the Constellation Observing System for Meteorology, Ionosphere, and Climate (COSMIC) RO dry temperature products. A limited number of matchup cases (within 100km and 1.5 hours) were found, with a sample shown in Figure 53 from the NSA site. In this case, NUCAPS is able to capture the overall structure through the atmosphere, but misses the smaller vertical structures like the cold tropopause feature that the ARM BE and COSMIC RO are able to resolve.

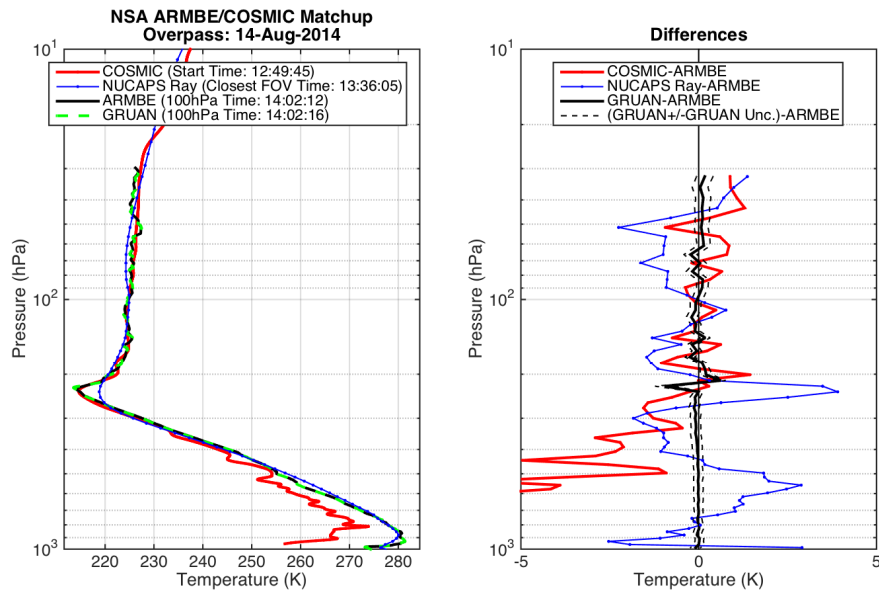
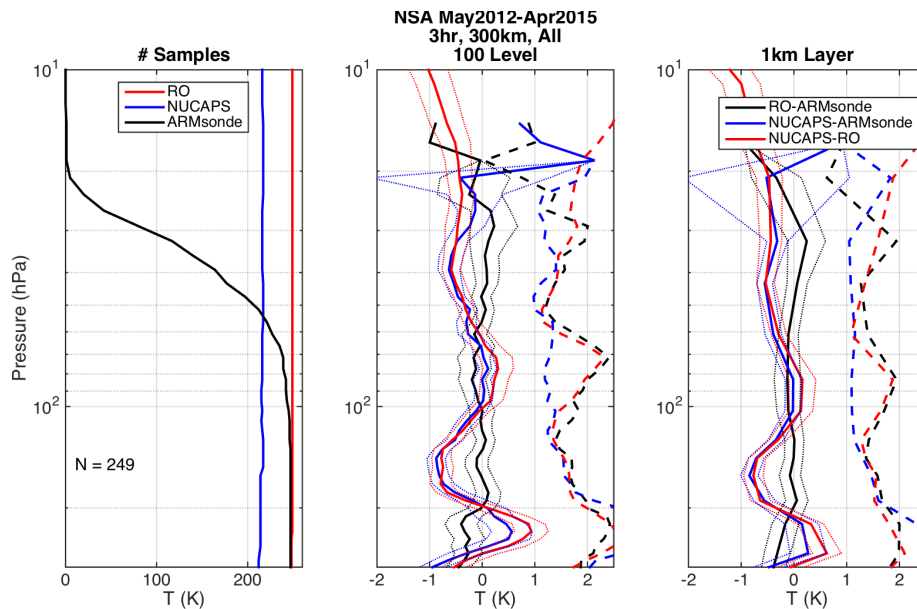

Figure 53. Comparison of ARM BE radiosonde, COSMIC RO, and NUCAPS temperature profiles (left) and differences (right) at NSA on 14 August 2014.

In order to increase the number of matchup cases between NUCAPS and COSMIC RO, the matchup criteria were relaxed to 300km and 3 hours and routine ARM radiosondes were included between May 2012 and April 2015. In general, the bias statistics of the differences show that RO is in good, <0.5K agreement with the radiosondes over the vertical range 200–30hPa. Figure 54 shows the matchup statistics at NSA, where it is evident that NUCAPS has a cold and warm bias on the order of 1K at ~150hPa and ~250hPa respectively. This is the type of error that was seen in the previous case study. Further analysis is ongoing.





**Figure 54. Comparison of ARM routine radiosondes, COSMIC RO, and NUCAPS temperature profiles at NSA, May 2012 – April 2015: number of samples (left), temperature differences on 100 levels (middle), and temperature differences on 1km layers (right). Bias (solid) & RMS (dashed).**

### Publications and Conference Reports

Borg, Lori and Knuteson, B. Ground-based measurements for T,q profiles and TCWV (Oral presentation). UK MetOffice, Exeter. ISSWG-2 12th meeting, 03-04 December 2015.

Borg, Lori, Tobin, D., Reale, T., Liu, Q., Nalli, N., Holdridge, D.; and Mather, J. Validation of S-NPP CrIMSS atmospheric temperature and water vapor retrievals using coordinated ARM site radiosondes (Poster presentation). Toulouse, France. European Organization for the Exploitation of Meteorological Satellites (EUMETSAT), 2015, P-1: Current and future satellites, instruments and their applications.

Feltz, M., R. Knuteson, L. Borg, S. Ackerman, and D. Tobin. Comparisons of IR Sounder and COSMIC RO Temperatures: Guidance for CrIS NUCAPS Validation (Oral Presentation). Proceedings of the 20<sup>th</sup> International TOVS Study Conference. Lake Geneva, Wisconsin, USA. 2015. Oral Presentation.

### References

Tobin, D. C., H. E. Revercomb, R. O. Knuteson, B. M. Lesht, L. L. Strow, S. E. Hannon, W. F. Feltz, L. A. Moy, E. J. Fetzer, and T. S. Cress (2006), Atmospheric Radiation Measurement site atmospheric state best estimates for Atmospheric Infrared Sounder temperature and water vapor retrieval validation, *J. Geophys. Res.*, 111, D09S14, doi:10.1029/2005JD006103.

### 18.2 Science and Management Support for NPP VIIRS Snow and Ice EDRs in 2015

**CIMSS Task Leader: Yinghui Liu**

**CIMSS Support Scientists: Xuanji Wang, Richard Dworak**

**NOAA Collaborator: Jeffrey Key**

**Budget: \$132,000**



### **NOAA Long Term Goals:**

- Climate Adaptation and Mitigation
- Weather-Ready Nation
- Healthy Oceans

### **NOAA Strategic Goals:**

- Serve society's needs for weather and water
- Understand climate variability and change to enhance society's ability to plan and respond
- Provide critical support for the NOAA mission

### **CIMSS Research Themes:**

- Satellite Meteorology Research and Applications

### **Objective**

Conducting research related to NPP VIIRS sea ice EDRs to check quality and perform comparisons.

### **Project Overview**

The Visible Infrared Imaging Radiometer Suite (VIIRS) provides the majority of the Environmental Data Records (EDR) on the Suomi National Polar-orbiting Partnership (NPP; formerly the NPOESS Preparatory Project) satellite. Cryosphere (snow and ice) products are fundamental to weather prediction, hazard detection, transportation, recreation, and climate monitoring, and are therefore an important part of the suite of VIIRS EDRs.

NESDIS/STAR is taking the managerial and technical leadership of NPP and Joint Polar Satellite System (JPSS) cryosphere product development and evaluation activities. The JPSS Cryosphere Team will produce snow and ice Environmental Data Records (EDRs) from visible, infrared, and microwave data. For the purposes of this proposal, however, only those EDRs produced from VIIRS are considered. The VIIRS snow and ice EDRs are sea ice characterization, ice surface temperature, and snow cover/depth. Sea ice characterization includes an ice concentration intermediate product (IP).

The Cryosphere Team is a unified combination of Subject Matter Experts (SMEs) from academia and government. Scientists from the Cooperative Institute for Meteorological Satellite Studies (CIMSS) at the University of Wisconsin-Madison are an integral part of the team. Research at CIMSS focuses on the sea ice EDRs, in collaboration with colleagues at the Cooperative Institute for Research in the Environmental Sciences (CIRES) at the University of Colorado-Boulder. Snow cover research is being conducted at the Cooperative Remote Sensing Science and Technology Center (CREST)/City College of New York (CCNY).

### **Milestones with Summary of Accomplishments and Findings**

Work at CIMSS continues to obtain VIIRS SDRs, IPs, and EDRs automatically from the GRAVITE system, checking the quality of these SDRs and EDRs, and performing comparisons of these IPs and EDRs with all other available datasets, visually and quantitatively. The SDRs include VIIRS moderate resolution band SDRs, VIIRS image band SDRs, and corresponding terrain-corrected geolocation SDRs. The IPs include VIIRS ice concentration IP, VIIRS ice reflectance and temperature IP, VIIRS ice quality flag IP, VIIRS ice weights IP, and VIIRS cloud



mask IP. The EDRs include VIIRS ice surface temperature EDR, VIIRS sea ice characterization EDR, VIIRS cloud cover and layers EDR.

The quality of the VIIRS IST EDR is examined comprehensively. Validation is performed through comparisons with multiple datasets, including NASA IceBridge measurements, air temperature from Arctic drifting ice buoys, Moderate Resolution Imaging Spectroradiometer (MODIS) IST, MODIS IST simultaneous nadir overpass (SNO), and surface air temperature from the National Centers for Environmental Prediction/National Center for Atmospheric Research (NCEP/NCAR) reanalysis, as an example in Figure 55. Results show biases of -0.34, -0.12, 0.16, -3.20, and -3.41 K compared to an aircraft-mounted downward-looking pyrometer, MODIS, MODIS SNO, drifting buoy, and NCEP/NCAR reanalysis, respectively, root-mean-square errors of 0.98, 1.02, 0.95, 4.89, and 6.94 K, and root-mean-square errors with the bias removed of 0.92, 1.01, 0.94, 3.70, and 6.04 K. Based on the IceBridge and MODIS results, the VIIRS IST uncertainty (RMSE) meets or exceeds the JPSS system requirement of 1.0 K. The product can therefore be considered useful for meteorological and climatological applications.

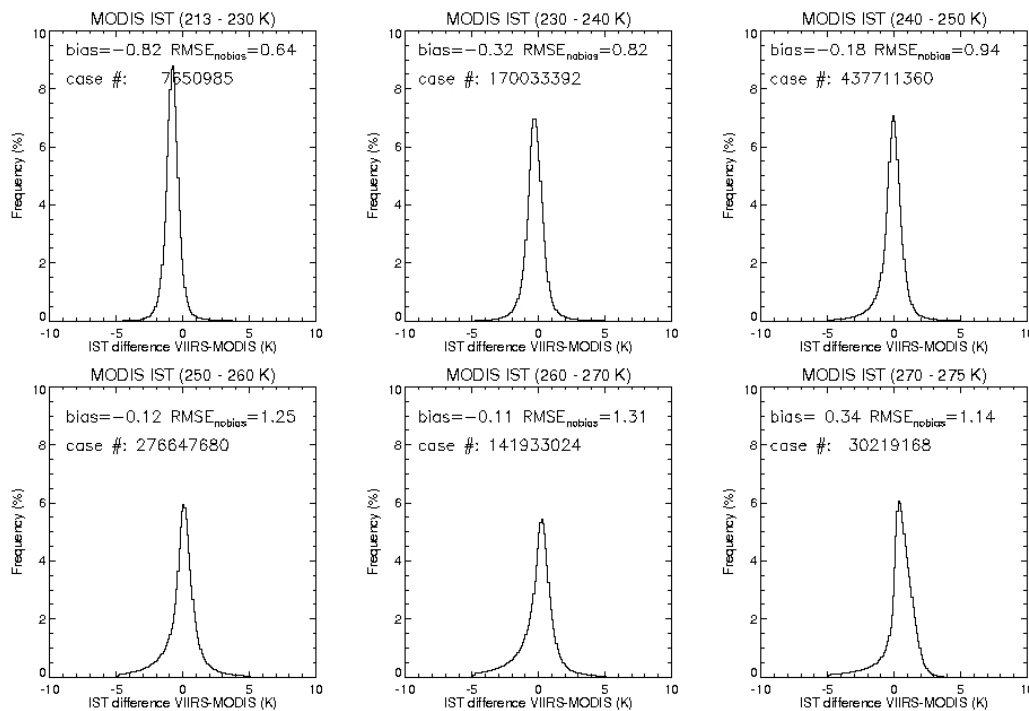

Figure 55. Histogram of ice surface temperature differences between NPP VIIRS and MODIS (Aqua and Terra) in the Arctic only from August 2012 to July 2015 for cases with MODIS ice surface temperature in the ranges 213-230 K, 230-240 K, 240-250 K, 250-260 K, 260-270 K, and 270-275 K. Measurement bias and RMSE<sub>nobias</sub> are indicated for each bin.

## References

Liu, Y.; Key, J.; Tschudi, M.; Dworak, R.; Mahoney, R.; Baldwin, D. Validation of the Suomi NPP VIIRS Ice Surface Temperature Environmental Data Record. *Remote Sens.* 2015, 7, 17258-17271.

Y. Liu, J. Key and R. Mahoney: Sea ice concentration from VIIRS on Suomi NPP and the future JPSS Satellites. Submitted to *Remote Sensing*.



## **19. JPSS Risk Reduction Algorithm Integration Team Midwest**

**CIMSS Task Leader: R. Garcia**

**CIMSS Support Scientists: W. Straka, G. Martin**

**NOAA Collaborators: W. Wolf**

**Budget: \$50K**

### **NOAA Long Term Goals:**

- Weather-Ready Nation

### **NOAA Strategic Goals:**

- Provide critical support for the NOAA mission

### **CIMSS Research Themes:**

- Satellite Meteorology Research and Applications

### **Objective**

Provide integration and technical support for the integration of the Enterprise algorithms for JPSS.

### **Project Overview**

For GOES-R, a substantial number of algorithms have been researched, implemented and demonstrated for operational integration. As a risk reduction to JPSS, NOAA is selecting and applying compatible GOES-R algorithms to demonstrate pseudo-operational processing capability using JPSS sensor data, by adapting the reference framework implementation and science software. JPSS AIT Midwest is principally a programming and integration support group providing computing, coding and process expertise in order to bridge research to operations and preserve algorithm interoperability, to assist science teams in developing and adapting algorithms for JPSS and to prototype and develop common software facilities and infrastructure.

### **Activities**

- Provide coding expertise, design input, and review for enhancements to AIT framework.
- Continue development of algorithm testbed (Geocat) and common algorithm interface and infrastructure as needed to support SNPP / JPSS algorithms
- Assist in validation and verification of test products, including comparisons with IDPS products.
- Develop any required testing tool enhancements required to validate or verify SNPP products processed with adapted GOES-R algorithms.
- Improve compatibility (algorithm APIs, libraries and components, toolsets) as needed between research, pseudo-operational, and IDPS operational systems.

### **Milestones with Summary of Accomplishments and Findings**

- Integrated and verified the CIMSS JPSS Risk Reduction algorithms to STAR Algorithm Processing Framework (SAPF) . This included all of the Cloud algorithms, Volcanic Ash, and several of the cryosphere algorithms for use with JPSS instrumentation.
- Support for December 2015 and April 2016 Delivered Algorithm Package (DAP) to NDE.
- Successfully compiled and ran SAPF locally at CIMSS for use by JPSS-RR algorithm developers.
- Participated and supported the Critical Design Review (CDR) for CIMSS JPSS-adapted algorithms.



- Provided coding expertise, design input, and review for enhancements to SAPF.
- Continued development of algorithm testbed (Geocat) and common algorithm interface and infrastructure as needed to support SNPP / JPSS algorithms.
- Assisted in validation and verification of test products, including comparisons with IDPS products.

## **20. CIMSS Participation in the JPSS Proving Ground/Risk Reduction Program for 2015**

### **20.1 Advancing Hyperspectral Sounder Applications in the Direct-Broadcast Environment**

**CIMSS Task Leader: Elisabeth Weisz**

**CIMSS Support Scientists: William L. Smith Sr., Nadia Smith, Kathy Strabala, Allen Huang**

**NOAA Collaborator: Mitch Goldberg**

**Budget: \$75,000**

#### **NOAA Long Term Goals:**

- Climate Adaptation and Mitigation
- Weather-Ready Nation

#### **NOAA Strategic Goals:**

- Serve society's needs for weather and water
- Understand climate variability and change to enhance society's ability to plan and respond
- Support the nation's commerce with information for safe, efficient and environmentally sound transportation
- Provide critical support for the NOAA mission

#### **CIMSS Research Themes:**

- Satellite Meteorology Research and Applications
- Satellite Sensors and Techniques
- Environmental Models and Data Assimilation
- Education and Outreach

#### **Objective**

Our objective is to serve the direct-broadcast (DB) community by making the best possible data products available and to increase the utility of hyperspectral sounding data products in meteorological real-time operations.

#### **Project Overview**

We aim to characterize hyperspectral retrieval software that is currently available to the national and international direct-broadcast (DB) user community through the UW/CIMSS Community Satellite Processing Package (CSPP). The main differences between the UW/CIMSS Dual-Regression (DR) retrieval algorithm and the NOAA Unique Combined Atmospheric Processing System (NUCAPS) and their implications on product quality and performance for a variety of atmospheric conditions (including severe weather) are investigated. We will pursue close collaboration with the DB users to address any concerns and ensure relevancy of the provided



algorithms and products. Our main goal is to promote and enhance the use of hyperspectral satellite data products in meteorological and environmental real-time applications.

### **Milestones with Summary of Accomplishments and Findings**

Due to their high spectral resolution, hyperspectral infrared sounders on polar-orbiting satellites, such as AIRS (Atmospheric Infrared Sounder), IASI (Infrared Atmospheric Sounding Interferometer) and CrIS (Cross-track Infrared Sounder), provide detailed information about the atmospheric vertical structure and composition, which has great value to weather monitoring and prediction systems. Different algorithms for the same instrument exist because the problem of inverting satellite radiances into atmospheric parameters is ill-posed and under-determined. This means that only estimates, which depend on user requirements, rather than unique solutions can be derived. An overview of the main differences between the DR method and NUCAPS and their impact on products and applications has been presented at the 20th International TOVS Study Conference (28 Oct - 3 Nov 2015, Lake Geneva, Wisconsin). This presentation (also published in the conference proceedings) provides a first step towards giving DB data users clear guidance on which algorithm and products to use in a specific application. One of the main differences is that the Dual-Regression (Smith et al. 2012, Weisz et al. 2013) is based on linear regression (but with additional steps added to minimize the non-linear dependence of the solution on the measured radiance), whereas NUCAPS (Gambacorta et al. 2013) includes a physical retrieval step. This makes the latter more time-consuming but can result in more refined sounding profiles, especially in the planetary boundary layer. NUCAPS also incorporates microwave data and performs cloud-clearing, which increases the retrieval yield below clouds, but decreases the spatial resolution from approx. 14 km to 50 km. On the other hand, DR provides retrievals for every single field-of-view (FOV), but outputs no retrievals below optical thick overcast clouds. Thus, differences in algorithm methodology and design cause product differences as can be seen by means of brightness temperatures (BT) at a window channel and selected retrieval products in Figure 56, which shows the remnants of tropical storm Bill on 21 June 2015. DR temperature and moisture retrievals under optically thick clouds and NUCAPS retrievals that do not pass the quality control are not displayed.

Currently CSPP NUCAPS can only be applied to CrIS measurements, but the same retrieval algorithm set-up is used operationally to process AIRS data, and IASI processing will be included in CSPP in the near future. Dual-regression can be applied to AIRS, IASI and CrIS radiance data providing a new source of information to real-time applications. For example, Weisz et al. (2015) demonstrated that a time sequence of hyperspectral retrievals, derived from multiple instruments in consecutive orbits, provides valuable information on the atmospheric destabilization associated with the convective development of severe local storms.

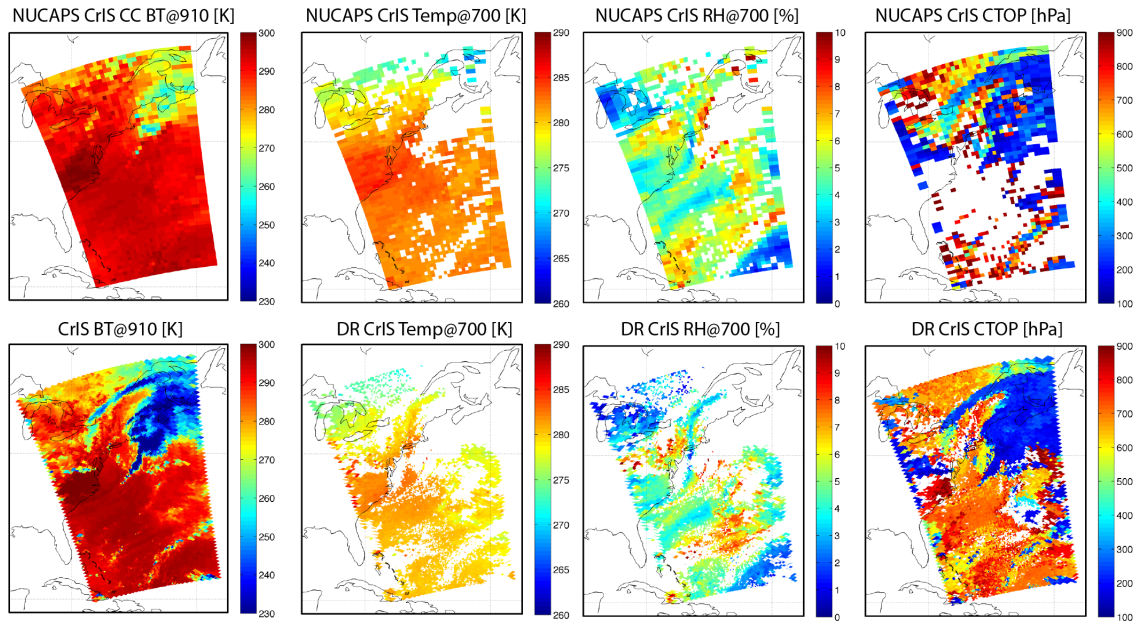

**Figure 56.** CrIS BT at  $910\text{ cm}^{-1}$  (left panels, top and bottom show cloud-cleared and original BT, respectively), retrieved temperature and relative humidity (RH) at the 700 hPa pressure level and cloud top pressure (CTOP), derived with NUCAPS (top) and UW Dual-Regression (bottom).

### Publications and Conference Reports

Weisz, E., N. Smith, and W. L. Smith (2015), The use of hyperspectral sounding information to monitor atmospheric tendencies leading to severe local storms. *Earth and Space Science*, 2.

Smith, W. L., E. Weisz, and N. Smith, Atmospheric Soundings from JPSS - Retrievals for NWP Data Assimilation. STAR JPSS 2015 Annual Science Team meeting, August 24-28, 2015, NCWP, College Park, MD.

Smith, N., B. Zavadsky et al., Novel Applications of Temperature Soundings in High Latitude Regions-Aviation in Alaska, 20th International TOVS Study Conference (ITSC-20), 28 October - 3 November 2015, Lake Geneva, Wisconsin, USA.

Smith, W. L., E. Weisz, and N. Smith, The Retrievals of Atmospheric Profiles from Satellite Radiances for NWP Data Assimilation, 20th International TOVS Study Conference (ITSC-20), 28 October - 3 November 2015, Lake Geneva, Wisconsin, USA.

Weisz, E., W. L. Smith, and N. Smith, Assessing Hyperspectral Retrieval Algorithms and their Products for Use in Direct Broadcast Applications, 20th International TOVS Study Conference (ITSC-20), 28 October - 3 November 2015, Lake Geneva, Wisconsin, USA.

Weisz, E., N. Smith, and W. L. Smith, Satellite-based Hyperspectral Sounder Retrievals in Real-time Weather Applications, 2015 AGU Fall Meeting, 14-18 December, San Francisco, California, USA.

Smith, W. L., et al., CrIS – The Evolution of the Operational Advanced Sounder, 96th AMS Annual Meeting, 9-14 January, 2016, New Orleans, Louisiana, USA.



## References

Gambacorta, A., et al. (2013), The NOAA Unique CrIS/ATMS Processing System (NUCAPS): Algorithm Theoretical Basis Documentation, Version 1.0, NOAA Center for Weather and Climate Prediction (NCWCP), 5830 University Research Court 2nd Floor, Office 2684 College Park, MD 20740-3818, USA.

Smith, W. L., E. Weisz, S. Kirev, D. K. Zhou, Z. Li, and E. E. Borbas (2012), Dual-Regression Retrieval Algorithm for Real-Time Processing of Satellite Ultraspectral Radiances. *J. Appl. Meteor. Clim.*, 51, Issue 8, 1455-1476.

Weisz, E., W. L. Smith, and Nadia Smith (2013), Advances in simultaneous atmospheric profile and cloud parameter regression based retrieval from high-spectral resolution radiance measurements. *Journal of Geophysical Research -Atmospheres*, 118, 6433-6443.

Weisz, E., N. Smith, and W. L. Smith (2015), The use of hyperspectral sounding information to monitor atmospheric tendencies leading to severe local storms. *Earth and Space Science*, 2.

## 20.2 Enhance the Utilization of Real Time JPSS Sounder Data in SDAT for Tropical Cyclone Forecast Application

**CIMSS Task Leader: Jun Li**

**CIMSS Support Scientists: Jinlong Li, Kevin Baggett, and Pei Wang**

**NOAA Collaborators: Mark DeMaria, John L. Beven, Vijay Tallapragada, Andrew Collard, and Tim Schmit**

**Budget: \$112,500**

### NOAA Long Term Goals:

- Weather-Ready Nation

### NOAA Strategic Goals:

- Serve society's needs for weather and water
- Support the nation's commerce with information for safe, efficient and environmentally sound transportation
- Provide critical support for the NOAA mission

### CIMSS Research Themes:

- Satellite Meteorology Research and Applications
- Environmental Models and Data Assimilation

### Objective

The objective is to use the NPP/JPSS sounder measurements for improving the prediction of tropical cyclone (TC) genesis and evolution.

### Project Overview

This is the second phase of our JPSS PGRR project and is the continuation of first phase project "Near real-time assimilation system development for improving tropical cyclone forecasts with NPP/JPSS sounder data" which ended in June 2015. The PI and the team propose to enhance the utilization of real time JPSS (Suomi NPP, JPSS1, JPSS2) sounder data in CIMSS Satellite Data Assimilation for Tropical storm forecast (SDAT) system (<http://cimss.ssec.wisc.edu/sdat>) while meeting the latency for tropical cyclone (TC) forecast application by increasing the model





horizontal resolution, using TC vital observations to improve the hurricane location initialization, and implementing the latest version of Community Gridpoint Statistical Interpolation (GSI) data assimilation system. The community satellite processing package (CSPP) real time products from Space Science Engineering Center (SSEC), Miami, and Puerto Rico direct broadcast (DB) sites will be assimilated into SDAT after converted to BUFR format that GSI assimilation system uses. The Cross-track Infrared Sounder (CrIS) data (radiances, cloud-cleared radiances, and soundings), along with the Advanced Technology Microwave Sounder (ATMS) will be the primary products from CSPP to be assimilated. SDAT will serve as the testbed to conduct research on improving the utilization of JPSS data, and the research topics include: better CrIS sub-pixel clear detection by using collocated high spatial resolution VIIRS cloud mask, which has been successfully demonstrated using AIRS/MODIS (Wang et al. 2014); CrIS radiance assimilation in cloudy regions; impact study on assimilating Unique CrIS/ATMS Processing System (NUCAPS) soundings and cloud-cleared radiances (CCRs), and impact study on assimilating the full spectral resolution CrIS water vapor absorption band radiances. The research progress will be implemented in SDAT for real time demonstration and TC forecast application. In addition, the research progress made with SDAT on JPSS sounder assimilation will also be tested with benchmark HWRF at STAR's supercomputer S4/Cardinal located at Space Science and Engineering Center (SSEC). CIMSS scientists will collaborate with Environmental Modeling Center (EMC) on possible transition of the research progress made by this project to operational HWRF.

CIMSS has been providing the SDAT forecast products in near real time (NRT) since September 2014 to ATCF (automatic tropical cyclone forecast) system that National Hurricane Center (NHC) uses. CIMSS scientists will collaborate with NHC on the application of SDAT products and get feedback/guidance from users for further improvement on JPSS sounder data assimilation and SDAT system.

## **Milestones with Summary of Accomplishments and Findings**

### ***CrIS CCR Assimilation (August 2015 – October 2015)***

Test dataset of CrIS cloud-cleared radiances (CCRs) from new version of algorithm have been provided by Chris Barnet in August 2015. CIMSS SDAT team has conducted experiments to address the following questions on SNPP data impact:

- (a) Does ATMS provide value-added impact beyond conventional data and all AMSU-A data?
- (b) Does CrIS provide value-added impact beyond conventional data, all AMSU-A and ATMS data?
- (c) Do CrIS radiances and CrIS CCRs provide comparable impact?

To address the above questions, the SDAT was used as research testbed to conduct assimilation experiments on Hurricane Sandy (2012). The following experiments were conducted

- (a) GTS + 4AMSU-A: assimilation of conventional data (GTS) and AMSU-A data from NOAA, Metop and Aqua;
- (b) GTS + 4 AMSU-A + ATMS: add ATMS;
- (c) GTS + 4 AMSU-A + ATMS+CrIS: add CrIS with GSI for cloud detection;
- (d) GTS + 4 AMSU-A + ATMS + CrIS (VIIRS) + CCR: add CrIS clear radiances with VIIRS cloud detection and CrIS CCRs in cloudy regions;
- (e) GTS + 4 AMSU-A + ATMS + CrIS (VIIRS) + CCR (ocean): add CrIS CCRs over ocean only.



Figure 57 shows that overall ATMS provides value-added impact beyond conventional data and four AMSU-A data, except the maximum wind speed.

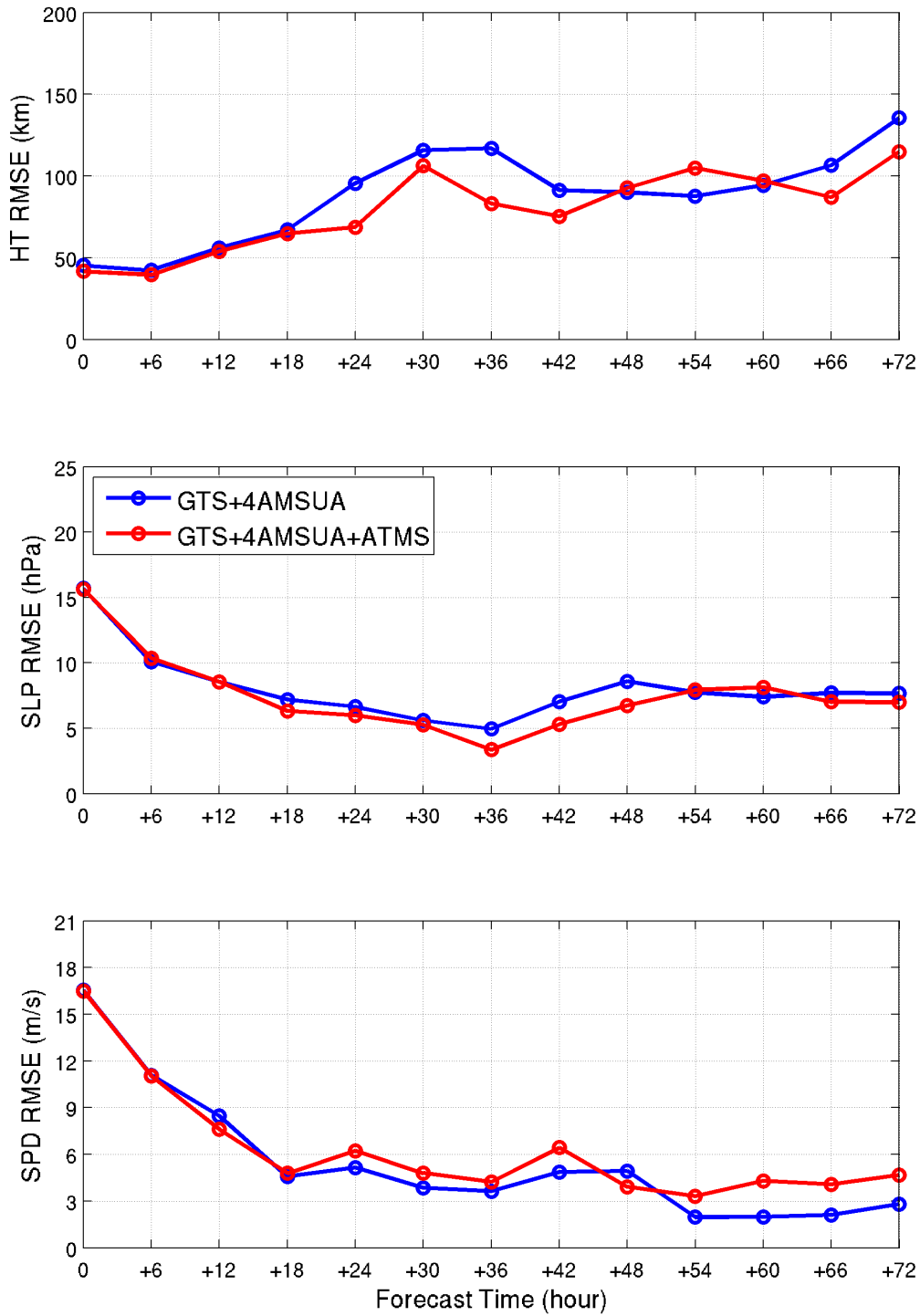
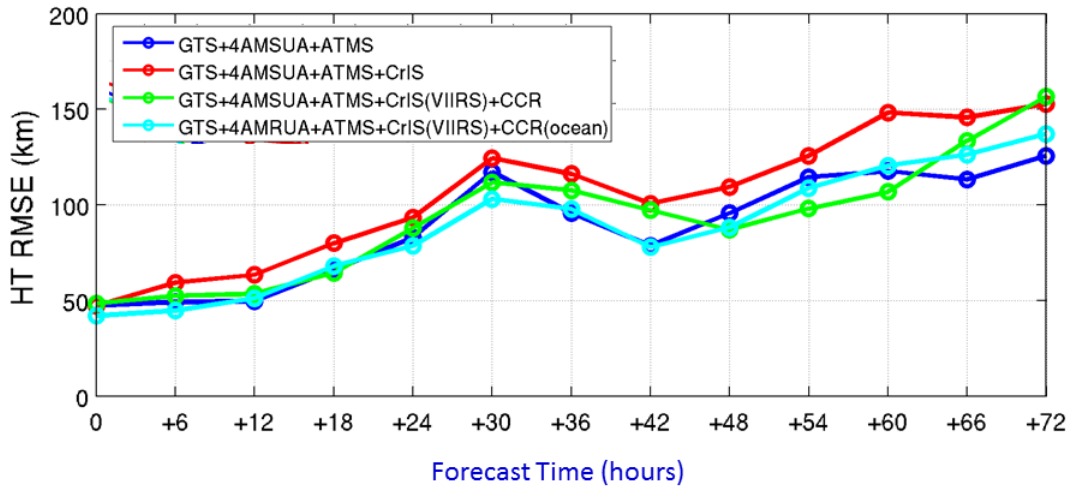

Figure 57. Forecast RMSE for Sandy (2012) track (upper), central sea level pressure (middle) and maximum wind speed (lower).



However, there is an interesting result:  
CrIS(VIIRS) + CCR over ocean only, gives us the best result



- (1) CrIS CCR provide additional information (mainly over cloudy regions) beyond CrIS clear only radiances
- (2) CrIS CCR over ocean is more reliable than over land, suggest to use CrIS CCR over ocean only
- (3) Work needed to improve CrIS assimilation in GSI system

Figure 58. The track RMSR from different experiments.

Figure 58 shows the track RMSR from different experiments. It can be seen that GTS+4AMSUA+ATMS provides good forecasts (blue) and adding CrIS with GSI cloud detection makes forecasts worse in this particular case, this might due to the cloud contaminated radiances to be assimilated as clear ones. However, CrIS CCR provides additional information (mainly over cloudy regions) beyond CrIS clear only radiances (with VIIRS cloud detection) (green line). CrIS CCR over ocean is more reliable than over land (cyan) for this particular case, more research will be conducted using CCRs with SDAT.

### ***SDAT Performs Reasonably Well for 2015 Hurricane Season, Especially for Hurricane Joaquin (September 2015 – March 2016)***

Assessment on 2015 hurricane season with SDAT has been conducted at CIMSS. In general SDAT has the similar performance of GFS and HWRF; SDAT provided reasonable forecasts for typical hurricanes in 2015 such as Erika and Joaquin which are a little difficult for dynamic models to predict in some time periods. For Hurricane Erika (25 – 19 August 2015), the forecasted tracks of most dynamic models along with official guidance are right to the best track, while the predicted tracks from the statistical models are most left to the best track, SDAT forecasts are very close to the best track, especially in the later times. For hurricane Joaquin (2015), many dynamic models predicted on 30 September and 01 October 2015 that the storm might turn to East Coast in a few days, but the hurricane went away from the coast to Atlantic Ocean. SDAT forecasts with IR and MW sounder radiance assimilated showed good agreement with the best track, indicating that the satellite sounder data are particularly important in the Joaquin forecasts, especially in the beginning time period (30 September and 01 October 2015). Figure 59 shows the 120-hour forecasts started at 00 UTC, 06 UTC, 12 UTC and 18 UTC on 01

October 2015 from SDAT (blue) and other operational NWP models, along with the best track (black).

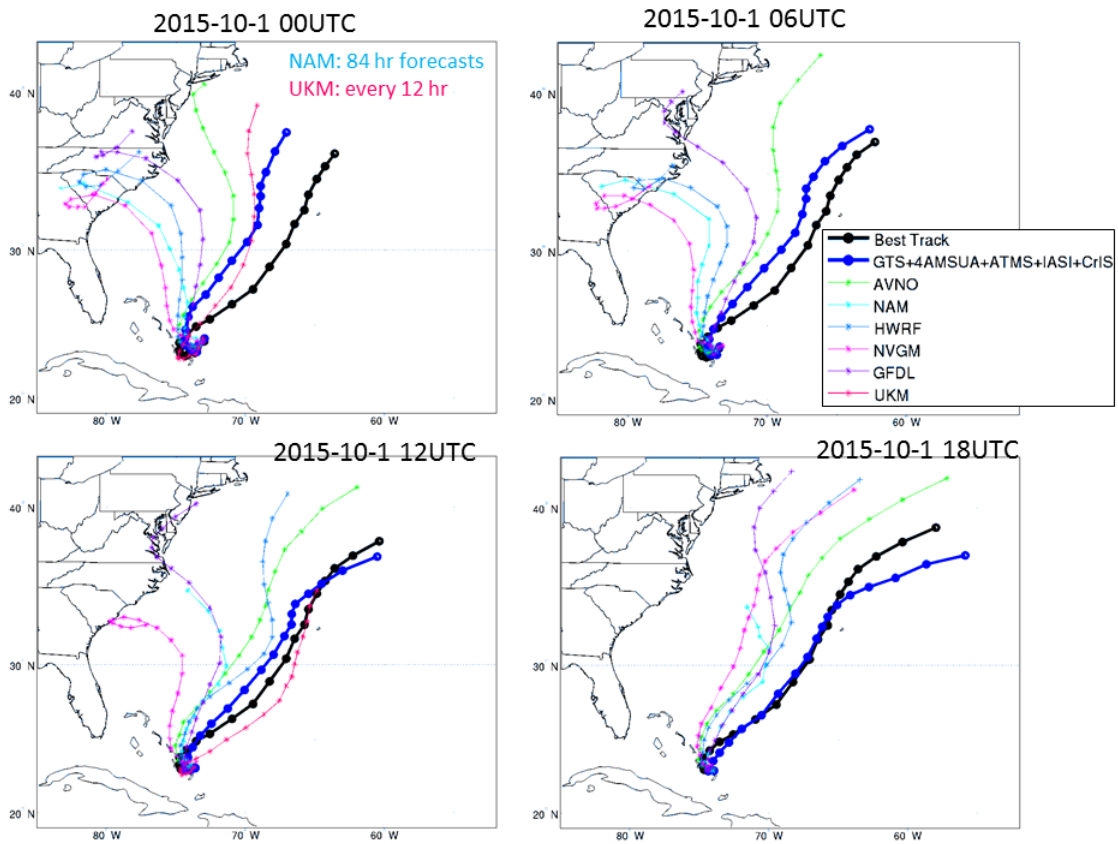

**Figure 59.** The hurricane Joaquin (2015) 120-hour forecasts started at 00 UTC, 06 UTC, 12 UTC and 18 UTC on 01 October 2015 from SDAT (blue) and other operational models, along with the best track (black).

It can be seen that with GOES and POES data assimilated, SDAT is closer to the best track, especially for forecasts started at 12 UTC and 18 UTC on 01 October 2015.

The hurricane Joaquin life-cycle forecasts from SDAT, HWRF and GFS are also compared for track, minimum sea level pressure and maximum wind speed. In general the three models have the similar performance for track, SDAT and HWRF have better intensity forecasts than GFS. It should be noted that both HWRF and GFS have better track forecasts in the very beginning, this is due to the relocation technique used in both HWRF and GFS, CIMSS is working to implement a similar technique for SDAT and hopefully the location initialization will be improved for next hurricane season (2016).

All the SDAT forecasts in 2015 hurricane season have been provided to NHC (Dr. Mark DeMaria) in January 2016 for overall assessment, CIMSS HIW team will get feedback and improve the SDAT for 2016 hurricane season.

***VIIRS-based Cloud-clearing Algorithm Developed for Deriving CrIS Cloud-cleared Radiances for Assimilation (June 2015 – March 2016)***

Handling clouds (such as IR sounder sub-pixel cloud characterization with collocated imager, imager-based cloud-clearing technique) for IR radiance assimilation very interested by EMC,



recommendation made by ITSC20 on using IR sounder sub-pixel cloud characterization for radiance assimilation, collaboration with EMC ongoing.

Using SDAT as research testbed, two approaches of handling clouds have been conducted for improving IR radiance assimilation, which is very interested by EMC.

- (a) Improve clear location (field-of-view) detection for IR radiance assimilation;
- (b) Using imager-based cloud-clearing technique developed at CIMSS for assimilating thermodynamic information in cloudy regions.

The above research has been published by CIMSS scientists (Li et al. 2005; Wang et al. 2014; 2015) and has impact on the operational applications. For example, the International TOVS Science Conference (ITSC20) (28 October – 03 November 2015, Lake Geneva, Wisconsin) has made recommendation that sub-pixel cloud characterization for IR sounder should be included in BUFR data for radiance assimilation in operational NWP models.

EMC Global Forecast System (GFS) data assimilation (DA) team (Drs. Andrew Collard and Haixia Liu) are interested in using imager-based IR sounder cloud-cleared radiances. Due to no water vapor band in VIIRS, the VIIRS-based CrIS cloud-cleared radiances (CCRs) might have a little larger uncertainty in water vapor absorption spectral region, evaluation will be conducted on VIIRS based CrIS CCRs.

We have successfully adapted MODIS/AIRS cloud-clearing algorithm and package to VIIRS/CrIS, and are conducting the assimilation experiments on Hurricane Joaquin (2015) case using CrIS CCRs (VIIRS-based). CIMSS will soon provide EMC the global test data-set of CrIS CCRs for GFS assimilation experiments.

#### ***Presentation to HWRP DA Team, Potential Collaboration on Improving Satellite Data Assimilation in HWRP Discussed***

EMC HWRP DA team (Drs. Vijay Tallapragada and Zhan Zhang) are interested in using thermodynamic information in the inner core region of tropical storm, which needs high spatial resolution IR data and better technique for handling clouds. VIIRS-based CrIS CCRs have the potential application in inner core region assimilation. Jun Li was invited to give a seminar at HWRP DA meeting on 10 December 2015 and discussed with HWRP DA team on future collaborations.

#### **Publications and Conference Reports**

Li, J., et al., 2015: On the assimilation of satellite sounder data in cloudy skies in the numerical weather prediction models, *Journal of Meteorological Research* (in press).

Li, J. et al., 2015: Progress on the assimilation of advanced IR sounder radiances in cloudy skies, The 20th International TOVS Conference (ITSC-20), 28 October – 03 November 2015, Lake Geneva, Wisconsin, U.S.A.

Li Jun, Pei Wang, Mitch Goldberg, Jinlong Li, Zhenglong Li, Agnes Lim, and Timothy J. Schmit, 2016: On the Assimilation of Advanced Infrared Sounder Radiances in Cloudy Skies, 96th American Meteorological Society Annual Meeting, New Orleans, LA, 10-14 January 2016.

Wang, Pei, Jun Li, M. Goldberg, et al., 2015: Assimilation of thermodynamic information from advanced IR sounder under partial cloudy sky conditions in regional NWP, *Journal of Geophysical Research – Atmosphere*, 120, 5469 - 5484 DOI: 10.1002/2014JD022976.



Wang, Pei, Jun Li, Yong-Keun Lee, Zhenglong Li, Jinlong Li, Zhiquan Liu, Tim Schmit and Steve A. Ackerman, 2016: The Impact of the High Temporal Resolution GOES and GOES-R Moisture Information on Severe Weather Systems in a Regional NWP Model, 96th American Meteorological Society Annual Meeting, New Orleans, LA, 10-14 January 2016.

### **20.3 High Resolution Trajectory-Based Smoke Forecasts using VIIRS Aerosol Optical Depth and NUCAPS Carbon Monoxide Retrievals**

**CIMSS Task Leader: James E Davies**

**CIMSS Support Scientists: Kathy Strabala, Russ Dengel**

**NOAA Collaborator: R. Bradley Pierce**

**Budget: \$75,000**

#### **NOAA Long Term Goals:**

- Weather-Ready Nation

#### **NOAA Strategic Goals:**

- Serve society's needs for weather and water

#### **CIMSS Research Themes:**

- Satellite Meteorology Research and Applications
- Environmental Models and Data Assimilation

#### **Objective**

This work addresses the need for low latency, web-based, high resolution forecasts of smoke dispersion for use by NWS Incident Meteorologists (IMET) to support on-site decision support services for fire incident management teams.

#### **Project Overview**

This project supports the Fire and Smoke (F&S) and Sounding Applications (NUCAPS, Atmospheric Chemistry) Initiatives of the 2016 Joint Polar Satellite System (JPSS) Proving Ground and Risk Reduction (PGRR) Program by using Visible Infrared Imaging Radiometer Suite (VIIRS) Aerosol Optical Depth (AOD) and combined Cross-track Infrared Sounder (CrIS) and Advanced Technology Microwave Sounder (ATMS) NOAA-Unique CrIS-ATMS Processing System (NUCAPS) carbon monoxide (CO) retrievals to initialize trajectory-based, high spatial resolution North American smoke dispersion forecasts.

#### **Milestones with Accomplishments and Findings**

A major accomplishment during this first year of the project was the development of a beta version of the CSPP NUCAPS EDR Science files. The beta version is based on the binary output from the NUCAPS Science Code and is a granule based netcdf file format for platform independence. The CSPP NUCAPS EDR files include averaging kernel, apriori, interpolation and inverse matrixes for applying to model (or insitu) profiles for data assimilation (or validation) activities. This work was accomplished in collaboration with Chris Barnet, Antonia Gambacorta at STC who provided IDL code to extract the averaging kernel eigenvalues from the NUCAPS binary files, generate the averaging kernels, construct the interpolation and inverse matrixes. This work directly addresses the recommendations of the CrIS Atmospheric Chemistry Data Users Workshop Report



([http://docs.lib.noaa.gov/noaa\\_documents/OAR/CPO/AC4/CrIS\\_workshop\\_2014.pdf](http://docs.lib.noaa.gov/noaa_documents/OAR/CPO/AC4/CrIS_workshop_2014.pdf)) which recommends the inclusion of averaging kernels and a priori information in the NUCAPS EDR for use by the atmospheric composition community.

A second major accomplishment involves the development of IDEA-I trajectory-based smoke forecasts using VIIRS AOD retrievals. Real-time IDEA-I VIIRS AOD trajectory forecasts, using GFS forecast meteorology, are now available (<http://sunset.ssec.wisc.edu/idea-i-aerosol-viirs/>). IDEA-I VIIRS smoke forecasts were conducted during the JPSS Fire and Smoke Initiative 2015 Western Region Case Study period (August 15-31, 2015) and compared to forecasts from the operational NESDIS IDEA to confirm the implementation within CSPP. Figure 60 shows results from the IDEA-I VIIRS AOD trajectory forecast for August 20, 2015. VIIRS observed high AOD over ID, WY, and MT (A) due to wildfires in this region on the 20th and IDEA-I trajectories predict that the majority of this smoke will be transported to the northeast and lofted (B) over Canada by the 22nd (shown by the white and pink trajectories, which indicate that the trajectories are more than 200mb above the surface and outside of the planetary boundary layer).

Finally, we incorporated real-time VIIRS AOD retrievals, VIIRS fire detection, and NESDIS Hazard Mapping System (<http://www.ospo.noaa.gov/Products/land/hms.html>) smoke analyses into RealEarth (<https://realearth.ssec.wisc.edu/>). These data can now be visualized simultaneously (found under the “Fires” Layer of the “Display Controls”). Figure 61 shows an example of the RealEarth visualization for March 28, 2016 (Julian Day 88). Valid VIIRS AOD retrievals are only obtained over the eastern US but VIIRS fire detection shows significant burning in Eastern OK and KS as well as Southern Mexico and Cuba. The HMS smoke analysis shows a large area of smoke over the Gulf of Mexico and smaller smoke plumes originating from the VIIRS fire detection locations. RealEarth allows the user to zoom in on specific locations so that the impact of individual fires and smoke plumes can be resolved on a county level over northeast OK and southeast KS.

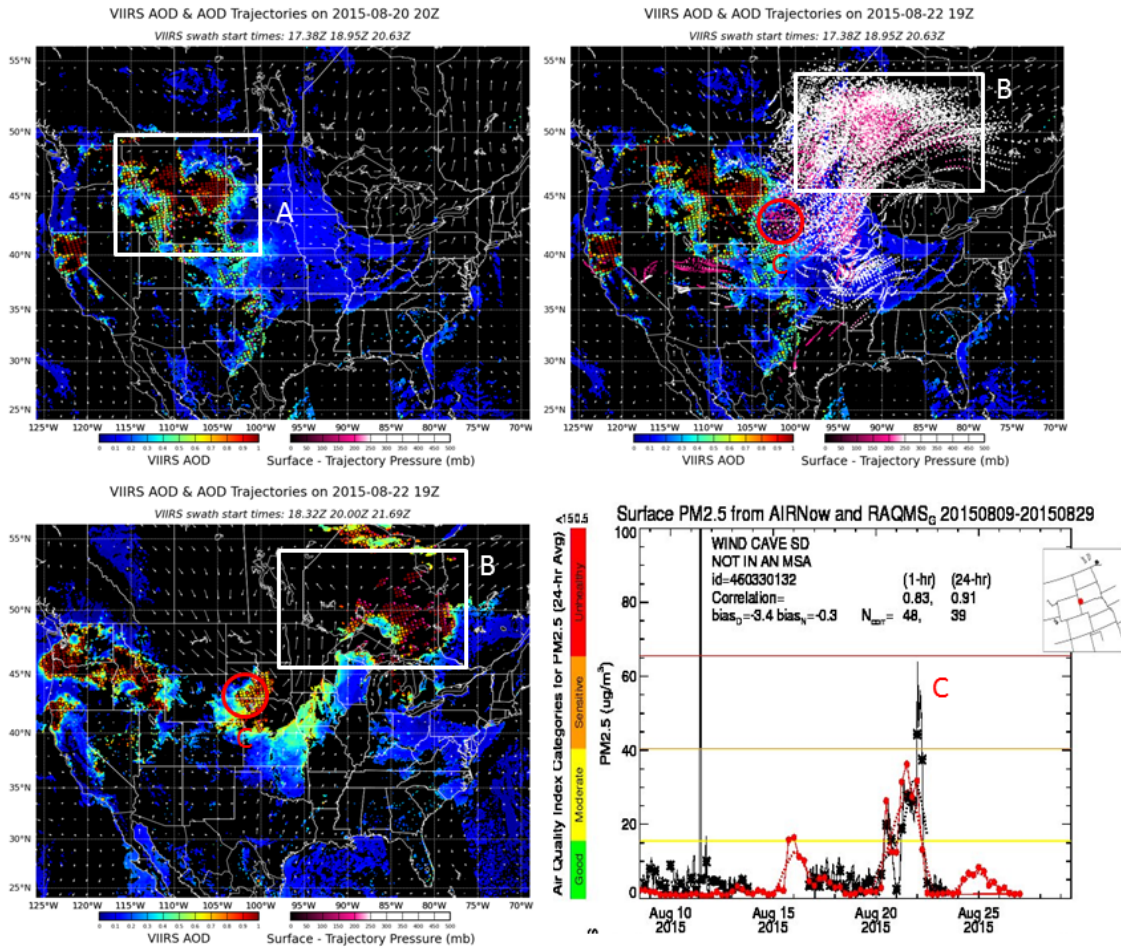

Figure 60. IDEA-I VIIRS AOD forecast for August 20, 2015 showing the VIIRS AOD on August 20, 2015 used for initializing the trajectories (upper left), the 48hr trajectory forecast valid at 19Z on August 22, 2015 (upper right), the VIIRS AOD on August 22, 2015 used to verify the trajectory forecast (lower left) and surface PM2.5 measurements (black) and RAQMS model PM2.5 predictions (red) at Wind Cave, SD (lower right).



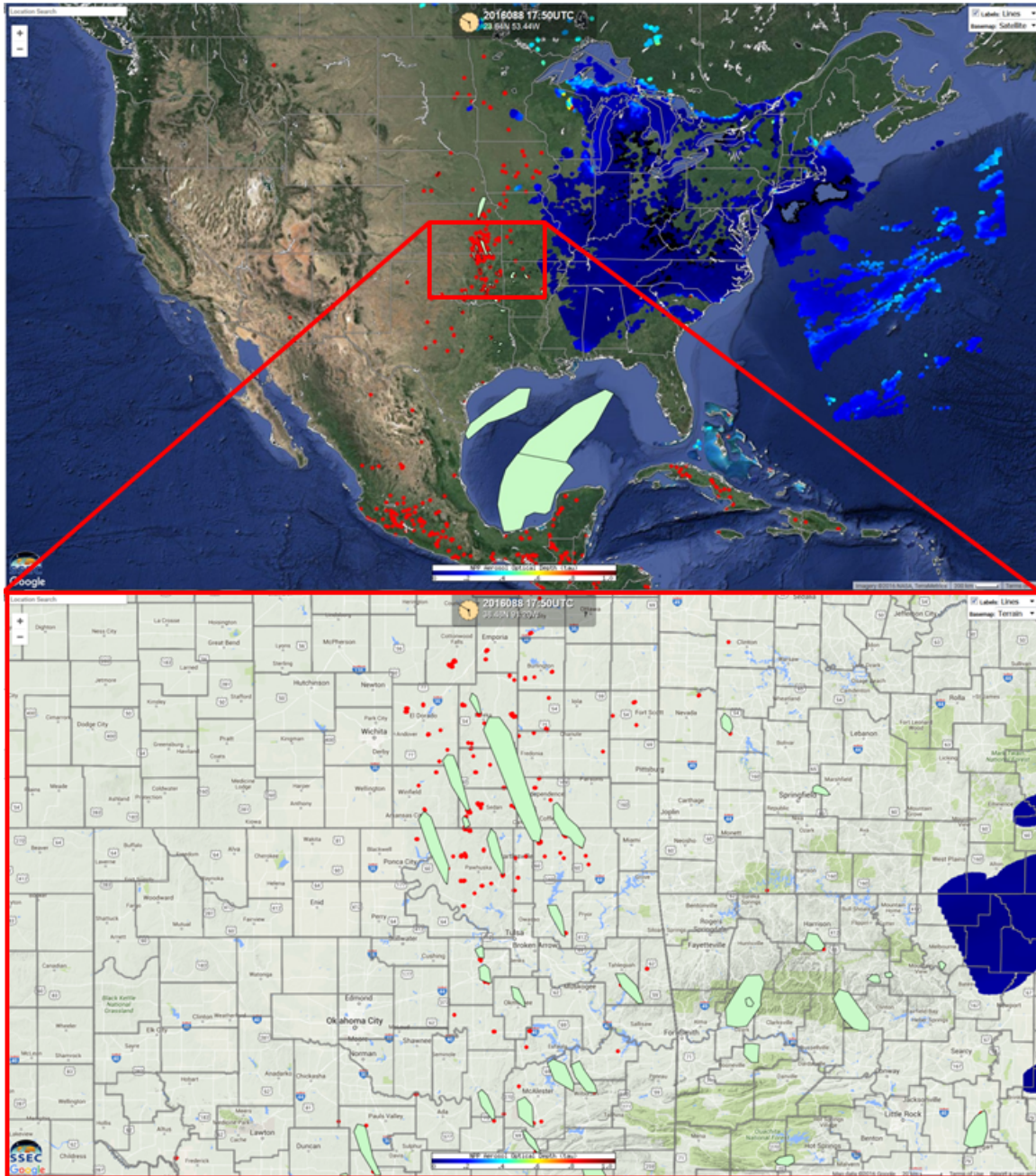

Figure 61. RealEarth visualization of VIIRS AOD retrieval (colored), VIIRS fire detection (red points), and HMS analysed smoke (light green objects) for March 28, 2016 and zoom over NE OK and SE KS.

### Publications and Conference Reports

Nadia Smith, R. Bradley Pierce, Chris Barnet, Gregory J. Frost, Michael Trainer, Si-Wan Kim, Stuart McKeen, Ravan Ahmadov, James E. Davies, John S. Holloway, Jeff Peischl, and Tom Ryerson, Characterizing NUCAPS retrieval quality for CO and CH<sub>4</sub> - A step towards improving air chemistry applications. At the 2015 International TOVS Study Conference (ITSC), October 28 - November 2, 2015 Lake Geneva, Wisconsin.

Nadia Smith, R. Bradley Pierce, Chris Barnet, Antonia Gambacorta, James E. Davies, Kathy Strabala, Integrating Satellite Measurements from Polar-orbiting instruments into Smoke



Dispersion Forecasts. At the 2015 Fall American Geophysical Union (AGU) Meeting, Dec 14-18, 2015, San Francisco, CA.

## **20.4 JPSS Cloud Cover Layers Development**

**CIMSS Task Leader: Andi Walther**

**CIMSS Support Scientists: Steve Wanzong, Mike Hiley**

**NOAA Collaborator: Andrew Heidinger**

**Budget: \$38,750**

### **NOAA Long Term Goals:**

- Weather-Ready Nation

### **NOAA Strategic Goals:**

- Serve society's needs for weather and water

### **CIMSS Research Themes:**

- Satellite Meteorology Research and Applications
- Environmental Models and Data Assimilation

### **Objective**

In 2014, the NWS Operational Algorithm Team (NOAT) selected the Cloud Cover Layers (CCL) Product as one of their top priorities for transition to operations. CCL reports the fraction of cloud at predetermined flight levels.

### **Project Overview**

In 2014, the NWS Operational Algorithm Team (NOAT) selected the Cloud Cover Layers (CCL) Product as one of their top priorities for transition to operations. CCL reports the fraction of cloud at predetermined flight levels. The accuracy of CCL is inherently tied to the ability to accurately detect and vertically place clouds. Many studies have highlighted the negative impact on cloud height accuracy due to the lack of IR absorption channels on VIIRS. VIIRS is not alone on S-NPP or JPSS, it flies next to the CrIS hyperspectral IR sounder, which provides high resolution measurements throughout the IR absorption bands. We intend to develop techniques to merge VIIRS and CrIS observations to allow for improved cloud height and CCL accuracies. The final product will benefit from the cloud height sensitivity of CrIS but maintain the high spatial resolution of VIIRS.

In addition, we will also address other expansions to the CCL products requested by the NOAT. We will include in the CCL product the fraction of cloud comprised of supercooled water and the fraction of cloud that is convective. The new cloud products will contribute to the computation of a sky cover grid for Alaska and surrounding coastal areas.

The NOAT guidance also emphasized the importance of the sky cover product. While a sky cover product was originally calculated based on cloud emissivity and cloud transmission from geostationary imagers for the contiguous United States and Hawaii, the climate and latitude of Alaska presents challenges for the computation of cloud products and sky cover that are uniquely addressed with VIIRS and CrIS data from the NPP satellite and JPSS, and the aforementioned proposed advancements in the cloud products from these sensors. The benefits extend beyond the temporal refresh of high spatial resolution imagery. It is envisioned that cloud transmission calculations from the VIIRS Day-Night Band (DNB) would significantly improve detectability of low cloud during the transitional seasons and winter months, when daylight is limited. The sky



cover product would provide a truth analysis upon which to validate NWS forecasts of sky cover that exist within the National Digital Forecast Database (NDFD).

### **Accomplishments and Findings**

- *Develop the Cloud Cover Layer Algorithm*  
The VCM continues to modify test thresholds as our experience with the VCM grows. We have developed tools to allow us to test changes to the VCM before they are implemented. The modifications continued in FY2015.
- *Implement the Generation of the VIIRS + CrIS Merged Level-1b Files*  
Part of this effort involves the use of CrIS data to improve VIIRS cloud heights. Existing tools were implemented from the SSEC/SIPS to make a merged Level-1b file.
- *Support Implementation of CSPP/CLAVR-x software at GINA*  
GINA was funded to purchase hardware to allow for the rapid generation of VIIRS cloud products in Alaska. The CIMSS effort continued to support the implementation of CIMSS software on the GINA hardware.
- *Modify CLAVR-x to support Sky-Cover on VIIRS DNB*
- *Implement the Sky-Cover Algorithm on VIIRS DB data at CIMSS*

## **21. CIMSS Participation in the 2015 JPSS Directed Risk Reduction Program**

### **21.1 Improving Very Short Range Forecasts for the NWS Alaska Region Using Objective Tools Designed to Optimize the Retention of Hyperspectral Infrared and Microwave Moisture LEO Soundings**

**CIMSS Task Leaders: Ralph A. Petersen, Lee Cronce**

**CIMSS Support Scientists: Richard Dworak, Nadia Smith, Elisabeth Weisz**

**NOAA Collaborators: Robert Aune (NESDIS), Bill Line CIMMS), Carven Scott (AR)**

**Budget: \$100,000**

#### **NOAA Long Term Goals:**

- Weather-Ready Nation

#### **NOAA Strategic Goals:**

- Serve society's needs for weather and water
- Support the nation's commerce with information for safe, efficient and environmentally sound transportation
- Provide critical support for the NOAA mission

#### **CIMSS Research Themes:**

- Satellite Meteorology Research and Applications
- Environmental Models and Data Assimilation

### **Project Overview**

This reports describes project accomplishments only since late fall 2016. This work is being performed in coordination with the National Weather Service (NWS) Alaska Region (AR) with the goal of increasing the operational utility of Low Earth Orbit (LEO) satellite soundings to forecasters and to help fill the large data gaps that exist between the sparse conventional observations and radar sites in AR. The long-term project objectives include: 1) assessing and validating various LEO sounder moisture products for use in very-short-range forecasting, 2) testing the impact of LEO-retrieval based NearCasts on improving a variety of AR operational



very-short-range forecast products specifically designed for the Alaska Region (AR) forecasting needs, and 3) determining the optimal information contained in both hyperspectral and microwave LEO moisture retrievals using a variety of algorithms. Initial seed funding was received in mid-2013 with the first year of full project funding was made available in mid-2014. A test version of the NearCast system is running in real time over the AR, however real-time data access currently limited product. Efforts to expand data coverage are ongoing.

### **Milestones with Summary of Accomplishments and Findings**

Forecasters in the Alaska Region have requested that short-range NearCasting techniques (developed for using GOES soundings over the CONUS) be applied to hyper-spectral sounder products generated from the multiple Low Earth Orbiting (LEO) satellites that make frequent overpasses at high latitudes (e.g., CrIS, IASI and AIRS). The hope is that these data will help fill the space and time gaps between sparse RAOB reports available there.

Recent efforts focused on demonstrating the potential of new short-range forecaster tools designed to use otherwise underutilized hyperspectral soundings in AR. Although these observations lack the spatial and temporal detail of GOES data, the increased vertical sounding resolution should be especially important both in areas with limited radar coverage or other synoptic observations and when conventional NWP guidance is questioned.

Forecasters have also noted the need for short-range guidance using full resolution satellite observations in cloudy conditions (not included in IR-only satellite products) for a variety of problems, especially those related to heavy precipitation events and oceanic weather systems. To address this need, NearCasts generated using combined IR/microwave retrievals are also presented to illustrate how these data can add short-range forecast information in areas where IR instruments are 'blind'. These observationally driven short-range projections could also provide a unique LEO/GEO synergy by filling spatial gaps in future high-time frequency GOES-R IR products and displays. In earlier reports, we:

- Studied the accuracy of several POES retrieval systems over Alaska;
- Demonstrated the NearCast using IASI data over Europe, using 2 different retrieval systems;
- Showed an example of a high-impact aviation event over Alaska (shown here); and
- Identified several outstanding data access issues.

As an example of the utility of CrIS and IASI retrievals through NearCast analyses and forecast depictions was studied for a case in which commercial aircraft were at risk of mechanical fuel availability problems due to 'gelling' which can occur at temperatures < -70C.

For the case, NearCasts analyses showed:

- The need to include real-time retrievals from BOTH CrIS and IASI from central data collection/processing sites in order to provide sufficient areal data coverage and full product coverage throughout the day;
- An extended areas of extremely cold air (~ -70oC) near 200 hPa before 1200 UTC Barrow and Fairbanks RAOBS were available, including extension over Arctic Ocean; and
- But indicate some inconsistency between nadir and limb retrievals – Feedback for satellite product developers.

NearCast Projections agreed well with nearby RAOBS at corresponding times and showed:

- Show slow progression of cold pool to north and east, and

- And would have been useful in determining air routes to avoid.

Modifications of NearCast display systems continue to be refined to accommodate gaps in NUCAPS analyses and NearCasts along limbs of satellite paths. Using the new modifications (Figure 62), the NCAPS retrievals appear to be more continuous and have fewer ‘limb effects’ than EUMETSAT IASI retrievals available for these tests. Data coverage improvements are also noted when both CrIS and IASI data are used together.

However, it was determined that for NearCasts to be successful, real-time data needed to be acquired for a wider area than could be observed by only using local data receivers. Much of the past 6 months has been spent trying to establish those data links to received retrievals processed in real-time at NESDIS centralized data sites. Due to these delays, much of the project effort has been put on a temporary ‘hold’ until reliable real-time data sources can be put in place. Initial data acquisition procedures for both real-time CrIS and IASI NUCAPS are currently being evaluated.

Alternative sources of real-time NUCAPS IASI retrievals continue, since the lack of this observations source is expected to degrade the effectiveness/utility of the NearCast system. Due to these real-time data access problems, Milestones for future tasks are being delayed until data acquisition issues are resolved, but these delays should have only minor affect on project budget.

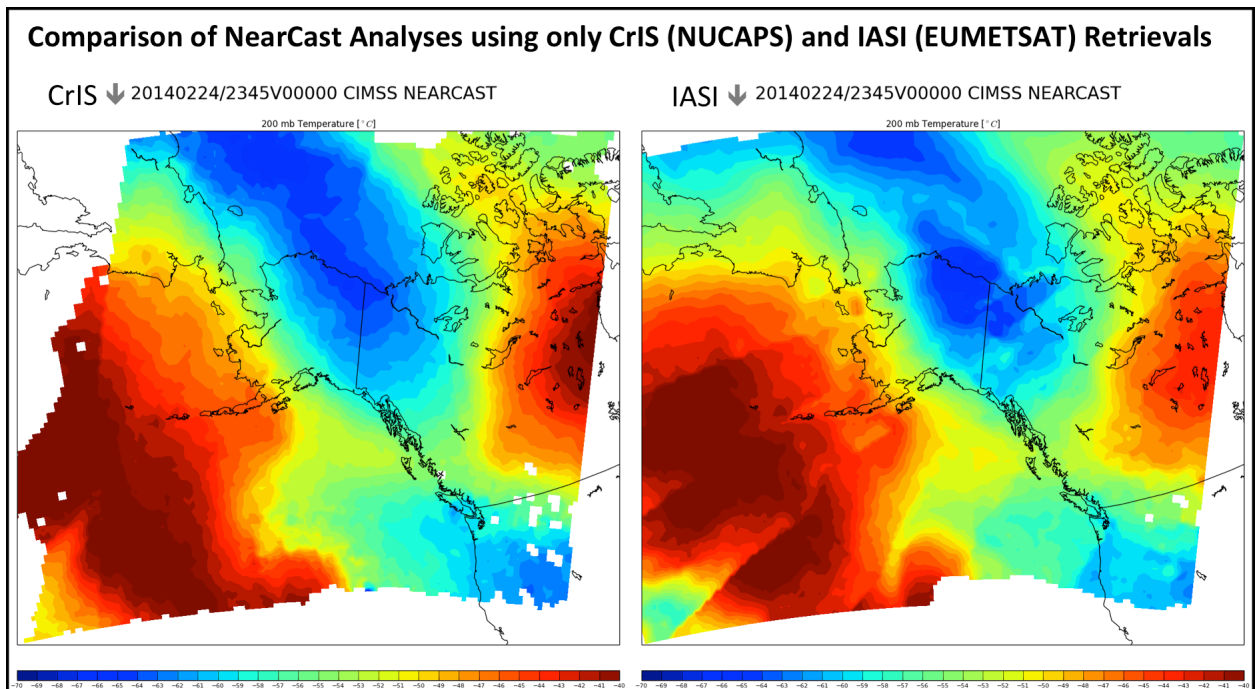

**Figure 62. Comparison of NearCast Analyses of 200 hPa temperature over Alaska using CrIS and IASI retrievals using NUCAPS and EUMETSAT retrieval systems. All retrievals analyzed onto grid comparable to mean NUCAPS retrieval footprint size (based on microwave FOV size), thereby smoothing some details present in IR-FOV sized IASI data.**

### Publications and Conference Reports

Petersen et al. at EUMETSAT IASI Workshop (April. 2016).



## **21.2 Ongoing Investigations in Support of the JPSS Program**

**CIMSS Task Leader: W. Paul Menzel**

**CIMSS Support Scientist: Elisabeth Weisz**

**NOAA Collaborator: Mitch Goldberg**

**Budget: \$40K**

### **NOAA Long Term Goals:**

- Climate Adaptation and Mitigation
- Weather-Ready Nation

### **NOAA Strategic Goals:**

- Serve society's needs for weather and water
- Understand climate variability and change to enhance society's ability to plan and respond
- Provide critical support for the NOAA mission

### **CIMSS Research Themes:**

- Satellite Meteorology Research and Applications
- Satellite Sensors and Techniques

### **Objective**

To extend the HIRS cloud data set with CrIS and IASI.

### **Project Overview**

Achieving the stated objective involves reducing the high spectral resolution CrIS/IASI data to resemble the HIRS broad band spectral coverage and using the resulting broad convolved radiances to estimate the cloud top pressures and effective emissivities. Co-located HIRS and IASI data from MetOp have been used to provide proof of concept. Application to CrIS data from SNPP is now being pursued. Additionally, the high spectral resolution data is being investigated to characterize the uncertainties in the broad band cloud products

### **Milestones with Summary of Accomplishments and Findings**

Global HIRS and HIRS-IASI data (IASI convolved to the HIRS broad band spectral response functions) were processed using CO<sub>2</sub> slicing plus IRW cloud top pressure (CTP) algorithms (Menzel et al 2008) for 19 January 2009. Cloud phase (determined using the tri-spectral technique, Strabala et al (1995)) was used to guide application of IRW for water and CO<sub>2</sub> slicing for ice clouds. Good agreement between HIRS and HIRS-IASI CTP results was found (Figure 63).

Additional investigations into cloud detection thresholds and viewing angles included the following: (a) when the HIRS-IASI sensor view was restricted to within 32 degrees of nadir and (b) when the HIRS-IASI cloud detection threshold was reduced from 0.5 to 0.1 mW/m<sup>2</sup>/ster/cm<sup>-1</sup>. Noise reduction is possible by convolving the IASI high spectral resolution IR measurements; the cloud detection threshold (clear minus cloudy radiance threshold) was reduced from 0.5 to 0.1 mW/m<sup>2</sup>/ster/cm<sup>-1</sup> for HIRS/IASI resulting in more CO<sub>2</sub> slicing solutions for high thin clouds.

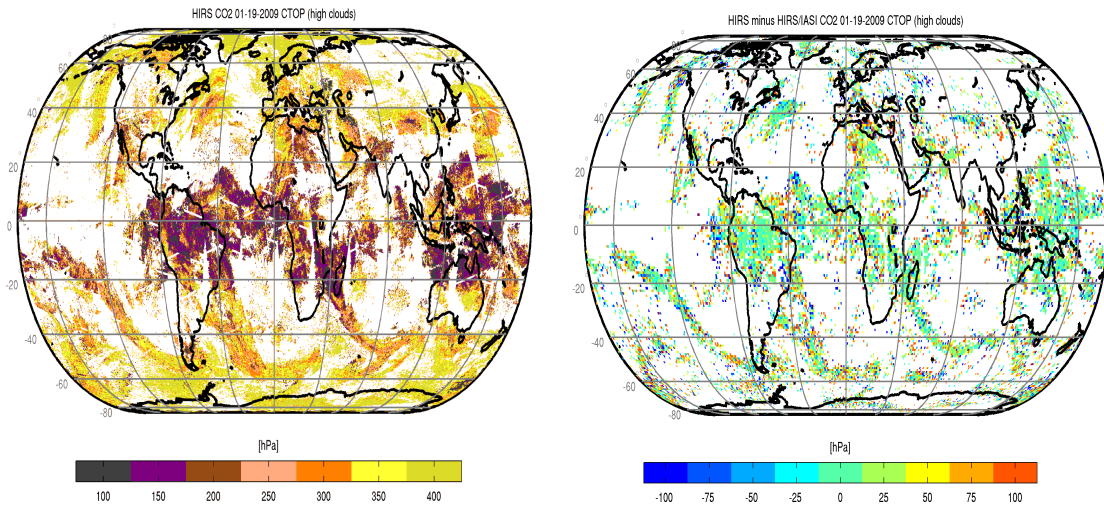

**Figure 63. Comparisons results for 19 January 2009. (left) HIRS CTPs (in hPa) using CO<sub>2</sub> slicing for ice and IRW for water clouds. (right) Difference HIRS minus HIRS-IASI CTPs (in hPa).**

Table 5 shows the break out of cloud detection for near nadir (within 32 degrees) versus all view angles by thin, thick, and opaque versus high middle, and low clouds for 60N to 60S. The restriction in view angle closer to nadir did not change the good agreement between HIRS and HIRS-IASI. For near nadir as for all view angles, HIRS-IASI finds more high clouds at the expense of low clouds; sampling and field of view differences between the two instruments are the likely causes. HIRS-IASI provides continuity for the HIRS cloud record, understanding that FOV size and sampling differences will adjust cloud detection percentages.

**Table 5. Classification (percentage of all observations) of HIRS (H) and HIRS-IASI (H-I) cloud determinations with  $\Delta R=0.5$  for 60N to 60S on 19 January 2009 for sensor view angle less than 55, 32 deg. High denotes CTPs < 440 hPa and Low CTPs > 660 hPa. Thin clouds have NE < 0.5 and Opaque clouds have NE > 0.95.**

% of all near nadir obs (view angle < 55, 32 deg) of HIRS & HIRS-IASI (H-I with $\Delta R=0.5$ ) 60N-60S clouds								
	Thin		Thick		Opaque		Total	
	HIRS	H-I	HIRS	H-I	HIRS	H-I	HIRS	H-I
High	17,18	23,25	13,13	14,14	3,3	2,2	33,35	40,41
Mid	4,4	5,5	6,6	5,5	3,2	2,2	12,12	12,12
Low	4,4	6,6	7,7	9,8	19,18	10,9	29,28	25,22

Table 6 shows the break out of cloud detection for near nadir (within 32 degrees) for HIRS with cloud detection threshold  $\Delta R=0.5$  and HIRS-IASI  $\Delta R=0.5$  and  $0.1 \text{ mW/m}^2/\text{ster/cm}^{-1}$  by thin, thick, and opaque versus high middle, and low clouds for 60N to 60S. The change in cloud detection threshold offers a look at how many thin clouds HIRS is missing when the cloud signal is within the HIRS noise threshold. With the better cloud detection threshold, 8% of the low and mid-level opaque clouds are reclassified as high thin ice clouds; the geographical distribution (not shown) reveals the location to be on the edges of cirrus cloud formations. Results from this work



to date support the conclusion that HIRS CTPs can be continued by using CrIS measurements convolved to HIRS spectral response functions.

**Table 6. Classification (in percentage of all observations) of HIRS (H) with  $\Delta R=0.5$  and HIRS-IASI (H-I) with  $\Delta R=0.5, 0.1$  cloud determinations for 60N to 60S on 19 January 2009 for sensor view less than 32 deg. High denotes CTPs < 440 hPa and Low CTPs >660 hPa. Thin clouds have  $NE < 0.5$  and Opaque clouds have  $NE > 0.95$ .**

% of all near nadir obs (view angle < 32 deg) of HIRS & HIRS-IASI (H-I with $\Delta R=0.5, 0.1$ ) 60N-60S clouds								
	Thin		Thick		Opaque		Total	
	HIRS	H-I	HIRS	H-I	HIRS	H-I	HIRS	H-I
High	18	25,31	13	14,14	3	2,2	35	41,49
Mid	4	5,4	6	5,4	2	2,2	12	12,9
Low	4	6,5	7	8,6	18	9,6	28	22,18

Results from this HIRS-IASI with the AVHRR cloud mask study (using a prototype algorithm that can be applied to CrIS with the VIIRS cloud mask superimposed) support the conclusion that HIRS CTPs can be continued by using CrIS/VIIRS as well as IASI/AVHRR measurements when the high spectral resolution IR measurements are convolved to HIRS broad band spectral response functions (CTPs can be expected to be within 25 hPa). The HIRS-CrIS application is being developed in early 2016.

**References**

Menzel, W. P., R. A. Frey, H. Zhang, D. P. Wylie., C. C. Moeller, R. A. Holz, B. Maddux, B. A. Baum, K. I. Strabala, and L. E. Gumley, 2008: MODIS global cloud-top pressure and amount estimation: algorithm description and results. *Jour of App Meteor and Clim.*, 47, 1175-1198.

Strabala, K. I., S. A. Ackerman, and W. P. Menzel, 1994: Cloud Properties Inferred from 8-12 micron Data. *Jour. Appl. Meteor.*, 33, 212-229.

**22. CIMSS Participation in the JPSS Risk Reduction Program for 2016**

**22.1 Application of JPSS Imagers and Sounders to Tropical Cyclone Track and Intensity Forecasting**

**CIMSS Task Leader: Chris Velden**  
**CIMSS Support Scientist: Derrick Herndon**  
**NOAA Collaborator: Mark DeMaria**  
**Budget: \$95,000**

**NOAA Long Term Goals:**

- Weather-Ready Nation





### **NOAA Strategic Goals:**

- Serve society's needs for weather and water
- Provide critical support for the NOAA mission

### **CIMSS Research Themes:**

- Satellite Meteorology Research and Applications
- Satellite Sensors and Techniques

### **Objective**

Demonstrate an innovative satellite-based consensus approach that will ultimately provide superior estimates of tropical cyclone intensity.

### **Project Overview**

The goals of this study are to 1) integrate previously successful research on developing objective methods to derive the intensity of tropical cyclones (TCs) from multi-spectral satellite sources (Leo and Geo), and 2) demonstrate an innovative satellite-based consensus approach that employs cross-method information sharing and performance analysis to weight the consensus member estimates and ultimately provide superior estimates of TC intensity. The outcome of this work will fuse TC intensity estimates derived by proven methods from ATMS, AMSU, SSMIS and GOES/GOES-R to yield improved TC intensity analyses that will benefit operational forecasts from the National Hurricane Center, the Central Pacific Hurricane Center, and the Joint Typhoon Warning Center. They will also benefit the initialization of operational hurricane forecast models such as the HWRF run at NCEP/EMC. The research community will benefit from the improved records of TC intensity through more reliable trend analyses for climate change studies.

The investigators will expand on extensive TC intensity analysis work done using the above sensors, with many of the methods already being utilized operationally by NOAA. Specifically, we plan to test, demonstrate and evaluate an innovative weighted consensus approach that takes advantage of the strengths of each individual satellite-based approach, and mitigates the weaknesses, making use of statistical performance in given situations.

### **Milestones with Summary of Accomplishments and Findings**

Milestone 1. In order to incorporate ATMS into SATCON, three types of weights are needed. The first two weights define the contribution of the ATMS estimates in the SATCON estimate at the time of the ATMS pass. These weights are defined in the SATCON algorithm by the RMSE for ATMS Minimum Sea Level Pressure (MSLP) and Maximum Sustained Winds (MSW). Table 7 and Table 8 show the aggregate ATMS performance for the periods shown. The RMSE can be stratified using TC eye size to indicate cases where ATMS estimate errors tend to be lower (large TC eyes greater than 40 km in diameter) and higher (eyes smaller than 45 km in diameter). The RMSE for eye sizes smaller than 40 km increases 12.0 knots. Therefore ATMS estimates for TC eyes with a diameter less than 40 km get less weight in SATCON. SATCON uses interpolated microwave estimates to increase the number of matches to the infrared-based Advanced Dvorak Technique and also to improve smoothness of the plots. Temporal variability and occasional large time gaps from microwave-based estimates require that those estimates have a limited range of influence with respect to time in SATCON. This problem defines the third weight. A weighting function was created that weights the interpolated microwave estimates (interpolated between each estimate as a post-processing step) based on estimate age. Beyond three hours, the estimate influence decays by the square of the distance in time between estimates resulting in the least amount of weighting at the mid-point.



Milestone 2. CIRA MIRS-based ATMS estimates are now available in near real-time. A complete evaluation of the CIRA ATMS estimates using cases from 2012-2015 is ongoing to determine inclusion in SATCON. CIRA ATMS estimates are now being plotted on the CIMSS SATCON plots for reference with the other objective intensity estimates.

**Table 7. CIMSS ATMS-derived TC intensity estimates: Dependent results from 169 TC cases in 2012-2015 as compared to operational Best Track estimates. MSLP is estimated TC minimum sea-level pressure, and MSW is estimated maximum sustained 1-min. surface winds. DVK MSW is the average of all available coincident operational Dvorak estimates.**

N=169	ATMS MSLP (hPa)	ATMS MSW (kts)	DVK MSW (kts)
Bias	-0.2	0.1	-2.7
Abs Error	5.6	8.8	7.7
RMSE	7.1	11.0	10.0

**Table 8. As in Table 7, except for independent sample of 58 cases from 2012-2015.**

N=58	ATMS MSLP (hPa)	ATMS MSW (kts)	DVK MSW (kts)
Bias	0.2	2.2	-4.4
Abs Error	5.3	7.5	8.7
RMSE	7.2	9.5	10.4

### Publications and Conference Reports

Velden, C., D. Herndon and T. Olander, 2015: Estimating Tropical Cyclone Intensity in the GOES-R/JPSS Era. 2015 NOAA Satellite Science Week, 23-28 February, 2015, Boulder, CO.

### 22.2 Strengthening TPW Visualization in the OCONUS Domain with JPSS Data Products

**CIMSS Task Leader: Anthony Wimmers**

**CIMSS Support Scientists: Christopher Velden, Jordan Gerth**

**NOAA Collaborators: Bill Ward, Carven Scott, Kennard Kasper, Xiwu Zhan**

**Budget: \$214,176 (2 years)**

### NOAA Long Term Goals:

- Weather-Ready Nation
- Healthy Oceans
- Resilient Coastal Communities and Economies



### **NOAA Strategic Goals:**

- Serve society's needs for weather and water
- Understand climate variability and change to enhance society's ability to plan and respond
- Support the nation's commerce with information for safe, efficient and environmentally sound transportation
- Provide critical support for the NOAA mission

### **CIMSS Research Themes:**

- Satellite Meteorology Research and Applications
- Satellite Sensors and Techniques
- Environmental Models and Data Assimilation
- Education and Outreach

### **Objective**

To produce an enhanced, state-of-the-art visualization (morphed animation) of total precipitable water (TPW) that incorporates JPSS retrievals to ensure the product's viability far into the future, delivered over AWIPS, and ready to be incorporated as a major enhancement to NOAA's operational capabilities.

### **Project Overview**

MIMIC-TPW is an experimental real-time product that uses data advection with background model winds in order to present an accurate over-ocean visualization of TPW at hourly intervals. This product has been valuable for OCONUS stakeholders forecasting tropical weather, atmospheric rivers and aerosol transport. For expediency, the existing algorithm utilizes only TPW retrievals from SSMI/SSMIS sources, but this limits the product to using older retrieval methods and leaves the product vulnerable to future data outages. This work will innovate the MIMIC-TPW algorithm to incorporate TPW retrievals from the JPSS constellation, and also improve the algorithm to rapidly process as many satellite sources as necessary. New algorithm development will be directed toward compatibility with NOAA's current operational Blended TPW product, so that a following iteration of work can more easily achieve a merger of the two systems.

The next generation product will be made available on a website and through an AWIPS pathway similar to the existing MIMIC-TPW product, and the product will be evaluated with feedback from NWS collaborators and their forecaster colleagues.

### **Milestones with Summary of Accomplishments and Findings**

The previous seven months have been directed toward testing new methods of data retrieval and full-globe compositing, in order to run a new real-time algorithm by September 2016. The major milestones in this effort are the following:

- *Run MIRS Ver.11 locally on real-time data.*  
Test a local run of MIRS Ver 11 on real-time SNPP ATMS, POES/Metop AMSU/MHS and DMSP SSMIS to prepare for a rapid, local TPW retrieval in near real-time.
- *Upgrade trajectory calculation with Reverse Domain Filling method.*  
Perform global domain trajectory calculations for Reverse Domain Filling, to speed up the data interpolation method by a factor of 10.



- *Apply morphological composite to global retrieval of TPW.*  
Test the morphological composite scheme in the global domain using these new sources of data (Figure 64).

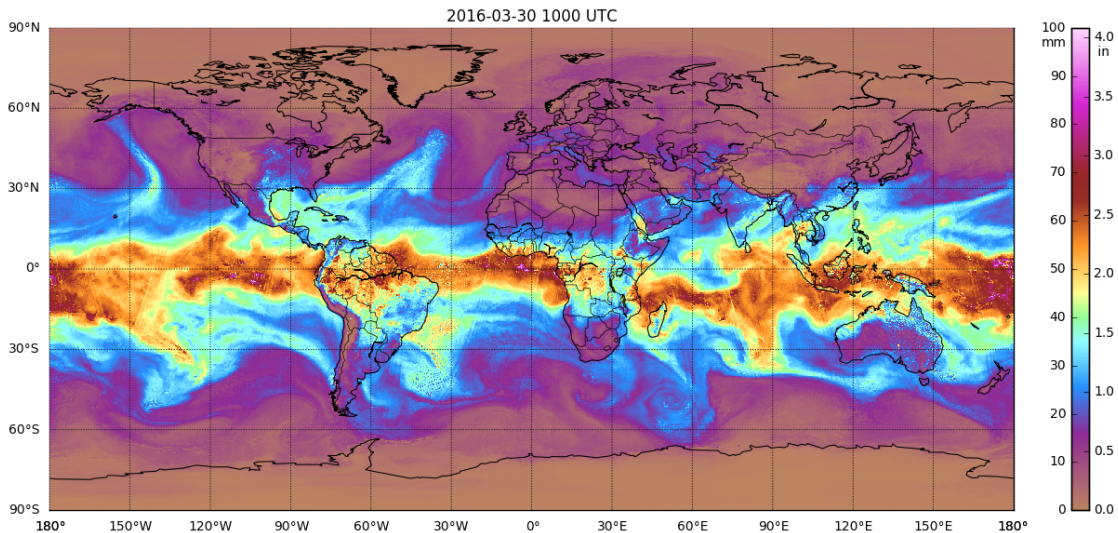

Figure 64. Morphological composite of TPW from SNPP ATMS, POES/Metop AMSU/MHS and DMSP SSMIS using the MIRS retrieval.

### Publications and Conference Reports

Wimmers, Anthony, Chris Velden, Jordan Gerth, Bill Ward, Carven Scott, Kennard Kasper, Xiwu Zhan, 2016: The global circulation of TPW at high temporal resolution from microwave satellites, American Meteorological Society 32nd Conference on Hurricanes and Tropical Meteorology, San Juan, Puerto Rico.

### 23. Polar Satellite Antenna for the National Weather Service in Guam

**CIMSS Task Leaders: Liam Gumley and Jordan Gerth**

**NOAA Collaborator: Bill Ward, National Weather Service Pacific Region Headquarters**

**Budget: \$300,000**

#### NOAA Long Term Goals:

- Weather-Ready Nation

#### NOAA Strategic Goals:

- Serve society's needs for weather and water
- Provide critical support for the NOAA mission

#### CIMSS Research Themes:

- Satellite Meteorology Research and Applications
- Education and Outreach

#### Objective

With NOAA, CIMSS/SSEC endeavors to install and operate a direct broadcast satellite data reception station at the National Weather Service (NWS) office in Guam to (a) acquire real-time



visible and infrared imagery, (b) serve imagery and related derived products to NWS meteorologists in Guam, (c) acquire and process infrared and microwave sounder data from polar-orbiting meteorological satellites, and (d) deliver the resulting products to NOAA with low latency for assimilation in numerical weather prediction (NWP) models.

### **Project Overview**

CIMSS/SSEC is working with the NWS to procure and install a polar satellite direct broadcast reception station in Guam for the benefit of the NWS forecast office there, and to provide real-time advanced infrared and microwave sounder data to NOAA National Centers for Environmental Prediction (NCEP) Environmental Modeling Center (EMC) for timely assimilation into their NWP models.

The NWS has demonstrated significant benefits of polar-satellite imagery and products in the forecast decision-making process, particularly in geographic areas that GOES does not serve well (e.g., Alaska), or in situations where geostationary satellite data do not provide sufficient spatial or spectral information (e.g., detecting low clouds and fog and night). For this purpose, advanced imagery and products from polar-orbiting satellites have provided new information to NWS forecasters to help with situational awareness. The Suomi National Polar-orbiting Partnership (NPP) satellite hosts the Visible Infrared Imaging Radiometer Suite (VIIRS). The VIIRS multispectral imager provides a rich source of new data for the NWS to apply to the operational weather forecast and analysis process. For example, NWS meteorologists have applied the VIIRS Day/Night Band (DNB) to detect low cloud and sea ice at night. The combination of imagery from Suomi NPP, Metop-A/B, NOAA-18/19, and Terra/Aqua, among others, means that data from at least seven satellites are available throughout the day to provide good temporal coverage. The Guam reception station scheduled for installation will provide imagery and higher-level products (e.g., sea surface temperature) from all these satellites with low latency and high reliability.

At present, NCEP EMC use of advanced infrared and microwave sounder data over North America and adjacent oceans in NWP data assimilation is limited because of the latency of the products in relation to the arrival deadlines for assimilation. The Guam reception station will deliver infrared and microwave sounder data to NCEP with the lowest latency possible, via the reception and processing of data received via direct broadcast. The goal is to reduce latency for advanced infrared and microwave sounder data to less than 15 minutes.

The reception system will include a polar satellite tracking antenna capable of acquiring data via direct broadcast on X-band and L-band from operational satellites including, but not limited to, Suomi NPP, Metop-A/B, NOAA-18/19, and Terra/Aqua. A dedicated processing system at the Guam station will create Level 1B (Satellite Data Record) and Level 2 (Environmental Data Record) products automatically in real time. Raw data from the station will be downloaded to SSEC where it will be processed upon arrival. SSEC will quality control and security scan the data and then transmit it to NCEP EMC using established secure Internet channels.

### **Milestones with Summary of Accomplishments and Findings**

The antenna procurement process is underway, and the antenna is scheduled for installation at the Guam forecast office by the end of 2016, subject to NWS progress in readying the site. The specific milestones, including those accomplished, and yet to be accomplished, related to this project, include efforts to:

1. Establish agreements with project partners (NOAA Joint Polar Satellite System Program Office and NWS) and draft interface control documents;



2. Procure a satellite data reception system from the vendor;
3. Procure a satellite data processing system from the vendor;
4. Install and test satellite data processing software;
5. Coordinate site preparation and installation planning with the vendor and NWS;
6. Travel to Guam for system installation and testing, as well as to train NWS staff in processing system operation and maintenance;
7. Install and test Advanced Weather Interactive Processing System (AWIPS) product delivery systems at the Guam forecast office; and
8. Provide additional derived products and imagery for AWIPS, and deliver associated training and support, as the NWS requires.

### **Publications and Conference Reports**

Increased Satellite Reception and Utilization Capabilities in NWS Pacific Region  
Talk, American Meteorological Society Annual Meeting—12th Symposium on New Generation  
Operational Environmental Satellite Systems (New Orleans, Louisiana)  
January 12, 2016.

## **24. The Development of the High Performance JPSS Analysis Facility for Instrument Impacts on Requirements (JAFIR)**

**CIMSS Task Leader: Allen Huang**

**CIMSS Support Scientists: Agnes Lim, Mat Gunshor, Zhenglong Li, Hong Zhang**

**Budget: \$300,000**

### **NOAA Long Term Goals:**

- Weather-Ready Nation

### **NOAA Strategic Goals:**

- Provide critical support for the NOAA mission

### **CIMSS Research Themes:**

- Satellite Meteorology Research and Applications
- Satellite Sensors and Techniques
- Environmental Models and Data Assimilation

### **Objective**

Evaluating the impact on forecasts from improved spatial resolution of field-of-view size (FOV) for CrIS and potential VIIRS instrument waiver analyses.

### **Project Overview**

This project consists of two tasks. The first is to evaluate the impact on forecast models from improved spatial resolution for CrIS and the second is to assist the science teams in assessment of instrument waivers on products for. For Task 1, reduced errors in the initial conditions and improved forecast models have led to steady improvements of forecast skill in the past three decades. Some of the reductions in initial condition errors come from increases in the quality and quantity of satellite observations. The spatial resolution of satellite observations must increase to maintain its positive influence on forecast skill as Numerical Weather Prediction (NWP) Centers move to higher resolution forecast models. Increasing the spatial resolution of satellite observations provide a higher probability that the observation is cloud free and decreasing spatial inhomogeneity in satellite observations is crucial for satellite radiance assimilation. This project



supports the National Oceanic and Atmospheric Administration's Joint Polar Satellite System (NOAA/JPSS) Program in planning for the next generation hyperspectral sounder where the forecast impact due to FOV size of the hyperspectral infrared sounder such as Cross-track Infrared Sounder CrIS instrument on NWP will be assessed.

The NOAA National Centers for Environmental Prediction's (NCEP) Global Data Assimilation system/Global Forecast System (GDAS/GFS) will be used. The forecast impact of the CrIS sensor with a smaller FOV will be assessed in the presence of the existing observing network to assess. Impact assessment will be performed in a simulated environment, also known as an Observing System Simulation Experiment (OSSE). Forecasts from two different scenarios will be compared to assess the forecast performance. The primary difference between these two scenarios will be the FOV size of CrIS observations. One scenario assimilates CrIS observations at the current spatial resolution whereas the other assimilates CrIS observations at half the current spatial resolution.

The second task proposed under this project was to continue the design and implementation of an analysis facility for VIIRS instrument waivers. The JPSS Analysis Facility for Instrument Impacts on Requirements (JAFIIR) project has been designed to conduct sensor modeling, measurement simulation, EDR algorithm adaptation and VIIRS instrument impact assessments on system requirements. This task follows the successful GOES-R Analysis Facility for Instrument Impacts on Requirements project (GOES-R AWG GRAFIIR).

The JAFIIR system leverages efforts from project activities of 1) GOES-R AWG GRAFIIR, 2) Community Satellite Processing Package (CSPP), 3) NPP proving ground, 4) VIIRS and CrIS calibration/validation, and 5) LEO Cloud Algorithm Testbed (LEOCAT).

### **Milestones with Summary of Accomplishments and Findings**

Task 1 milestones were generally met within the timeline proposed. The simulation of current observing data types has been split into a few components: simulation of conventional data (excluding dropsondes, NEXRAD and satellite winds), simulation of satellite observations, and simulation of GPSRO observations. Observations location and time were identical to those in the real world. Further development had been carried out on the orbit simulator to support all a7 sensors on 7 different satellites required in the OSSE. The orbit simulator had been verified to generate data coverage very similar to that of real observations. Figure 65 shows a comparison of the distribution of detectors across one scanline for both the current and the next generation CrIS simulated using the orbit simulator. Simulated satellite radiances were carried out using the Community Radiative Transfer Model (CARTM). Figure 66 shows simulated brightness temperatures for CrIS. Simulation of all observations required for the OSSE study (5 months) had been completed. These observations were all noise free.

Differences between the nature run and the NWP model will be introduced into the initial conditions, hindering the assessment of the impact of the candidate observing system (Masutani et al, 2010). An initial atmospheric state that did not deviate too far from the nature run had to be generated from a real analysis. We adopted a similar method as that used by Errico et al (2013). The initial conditions for the OSSE will be generated through the assimilation of high density rawinsonde observations at every 0.5 degree latitude/longitude drawn from the NR, without errors added, for 12 days to bring the real analysis close to the NR but not exactly the same. Comparison of statistics from the assimilation results and nature run showed that the real analysis had been nudged close to the nature run after a week.



Utility packages to add noise to ideal observations (observational noise simulator) and an encoder to write satellite observations into the BUFR format so that the observations can be read into the assimilation system are nearly completed. Refinement is still in progress, as it needs feedback from the calibration step.

For calibration, statistics are compared between real world and simulated world. Real world OSEs needed have been run with the latest data usage (November 2015) as in the operation and planned statistics to be used in the calibration process have also been derived. OSSE experiment using noise free observations (to act as a reference) has also been completed. Currently the experiment using simulated observations with one factor of noise added is in progress. Figure 67 shows the progress of the project up until March 2016.

Task 2 milestones, related to JPSS waiver activity, were to attend JPS waiver meetings via telephone and web-meeting software, to collaborate with JPSS science teams on implementation and interpretation of algorithm outputs during waiver analysis, and to follow CSPP software development to acquire up-to-date SDR and EDR packages. There was no JPSS waiver activity during the reporting period. CSPP software development has continued and the JAFIIR team continued to maintain their software and tools in the event of a waiver request.

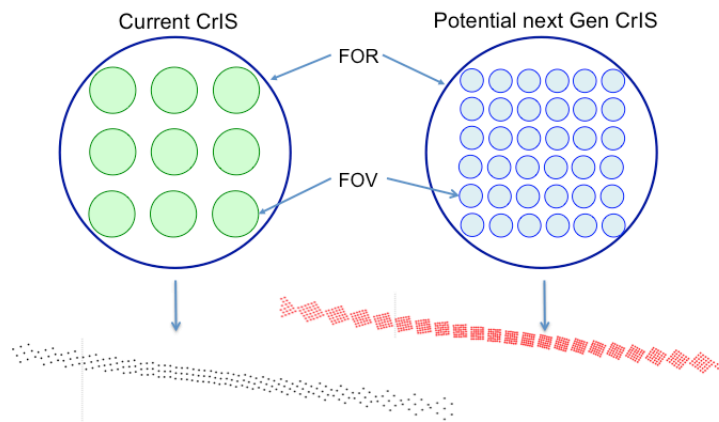

Figure 65. Layout of detectors for current and next generation CrIS.

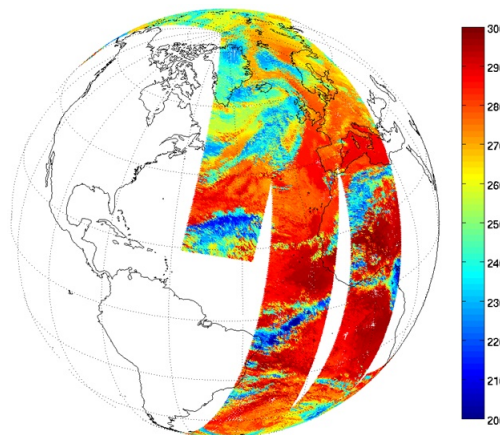

Figure 66. Simulated brightness temperatures using the orbit simulator to generate satellite geometry information for S-NPP CrIS channel 482 (CO<sub>2</sub>).



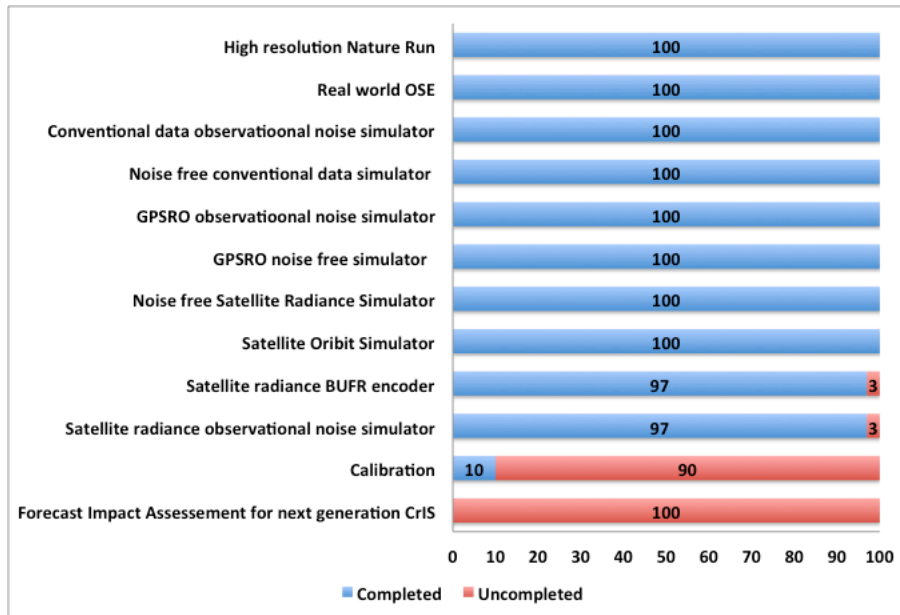

Figure 67. Progress of various components of the OSSE as of March 2016.

### Publications and Conference Reports

Lim, Agnes; Li, Z.; Jung, J. A.; Huang, A.; Woolen, J.; Quinn, G.; Nagle, F. W.; Healy, S. B.; Otkin, J. A.; Goldberg, M. and Atlas, R. Impact analysis of LEO hyperspectral sensor IFOV size on the next generation high-resolution NWP model forecast performance. 20th International TOVS Study Conference. Lake Geneva, Wisconsin, 27 October – 3 November 2015.

Lim, Agnes; Li, Z.; Jung, J. A.; Huang, A.; Woolen, J.; Quinn, G.; Nagle, F. W.; Healy, S. B.; Otkin, J. A.; Goldberg, M. and Atlas, R. Next Generation LEO Hyperspectral Sensor IFOV Size Impact on the High-Resolution NWP Model Forecast Performance - An OSSE Study. The Sixth Asia/Oceania Meteorological Satellite Users' Conference, Tokyo, Japan, 9-13 November 2015.

Lim, Agnes; Li, Z.; Jung, J. A.; Huang, A.; Woolen, J.; Quinn, G.; Nagle, F. W.; Healy, S. B.; Otkin, J. A.; Goldberg, M. and Atlas, R. Impact analysis of LEO hyperspectral sensor IFOV size on the next generation high-resolution NWP model forecast performance. Boston, MA, American Meteorological Society, 2016.

Lim, Agnes; Li, Z.; Jung, J. A.; Huang, A.; Woolen, J.; Quinn, G.; Nagle, F. W.; Healy, S. B.; Otkin, J. A.; Goldberg, M. and Atlas, R. Analysis of CrIS FOV sizes on the next generation high-resolution NWP model forecast performance through an OSSE. Boston, MA, American Meteorological Society, 2016.

### References

Errico R.M., R. Yang, N. Prive, K-S Tai, R. Todling, M. E. Sienkewicz and J. Gao, 2013: Development and validation of observing system simulation experiments at NASA Global Modelling and Assimilation Office, Q. J. R. Meteorol. Soc., 139, 1162-1178.

Masutani M. T. W. Schlatter, R. M. Errico, A. Stoffelen, E. Anderson, W. Lahoz, J.S. Woolen, G. D. Emmitt, L.P. Risshojguard and S. J. Lord, 2010: Observing System Simulation Experiments, in Data Assimilation: Making Sense of Observations, edited by W. Lahoz, B. Khattatov and R. Menard, 2010, Springer.



## **25. The Development of a Community Satellite Processing Package (CSPP) in Support of Suomi NPP/JPSS Real Time regional (RTR) Applications for 2015**

### **25.1 The Development of a Community Satellite Processing Package (CSPP) in Support of Suomi NPP/JPSS for 2015**

**CIMSS Task Leaders: Allen Huang (PI), Liam Gumley (PM)**

**CIMSS Support Scientists: Scott Mindock, Ray Garcia, Graeme Martin, Geoff Cureton, Kathy Strabala, Nick Bearson, Jim Davies, Jess Braun**

**NOAA Collaborator: Mitch Goldberg**

**Budget: 300K**

#### **NOAA Long Term Goals**

- Weather-Ready Nation

#### **NOAA Strategic Goals**

- Serve society's needs for weather and water
- Provide critical support for the NOAA mission

#### **CIMSS Research Themes**

- Satellite Meteorology Research and Applications
- Satellite Sensors and Techniques

#### **Objective**

To continue to support and update existing capabilities and add new capabilities of the Community Satellite Processing Package (CSPP) for imager and sounder data received via direct broadcast from polar orbiting satellites including primary satellite Suomi NPP, but also the NOAA-18/19, Metop-A/B, and Terra/Aqua satellites. A particular focus is the release of NOAA-developed algorithms and software for creating products from these satellites.

#### **Project Overview**

The Community Satellite Processing Package (CSPP) supports the Direct Broadcast (DB) meteorological and environmental satellite community through the packaging and distribution of open source science software. CSPP supports DB users of both polar orbiting and geostationary satellite data processing and regional real-time applications through distribution of free open source software, and through training in local product applications.

The Suomi NPP/JPSS component of the Community Satellite Processing Package (CSPP) for DB transforms VIIRS, CrIS, and ATMS RDRs to SDRs and selected EDRs and Level 2 products, and is optimized for real-time processing and regional applications. The CSPP software has the following capabilities:

- Ingest CCSDS packet files from VIIRS, CrIS, ATMS and NPP spacecraft diary;
- Create SDR, EDR, and Level 2 products for VIIRS, CrIS, and ATMS;
- Produce SDR output files in the HDF5 formats defined by the JPSS Common Data Format Control Books;
- Retrieve all required dynamic non-spacecraft ancillary data automatically;
- Run natively on 64-bit Intel Linux host platforms;
- Run on Microsoft Windows and Apple OS X platforms via a Virtual Appliance;



- Allow the end user to customize which EDR products are created;
- Provide a simple algorithm chaining capability to run algorithms in sequence;
- Provide detailed logs of all processing operations and give clear indications of where and when failures occur;
- Provide products optimized for NWS which are AWIPS and/or NOAA NextGen compatible; and
- Provide value-added products for end users that are not part of the JPSS operational suite, such as images in KML format for Google Earth; Night Fog Detection; Volcanic Ash; and Aviation Safety products.

### Milestones with Summary of Accomplishments and Findings

As of April 2016, the CSPP suite includes software for generating the following products on CentOS 64-bit Linux for Intel platforms:

1. SDR	VIIRS, CrIS, and ATMS geolocated and calibrated earth observations.
2. VIIRS EDR	VIIRS imager cloud mask, active fires, surface reflectance, vegetation indices, sea surface temperature, land surface temperature, and aerosol optical depth.
3. HSRTV	Hyperspectral infrared sounder retrievals of temperature and moisture profiles, cloud properties, total ozone, and surface properties.
4. Polar2grid	Reprojected imagery (single and multi-band) in GeoTIFF and AWIPS formats.
5. Hydra	Interactive visualization and interrogation of multispectral imagery and hyper spectral soundings.
6. MIRS	Microwave sounder retrievals of temperature and moisture profiles; surface properties; snow and ice cover; rain rate; and cloud/rain water paths.
7. CLAVR-x	Multispectral imager retrievals of cloud properties; aerosol optical depth; surface properties; ocean properties.
8. NUCAPS	Combined hyperspectral infrared sounder and microwave sounder retrievals of temperature and moisture profiles, cloud cleared radiances, and trace gases.
9. IAPP	Combined infrared sounder and microwave sounder retrievals of temperature and moisture profiles, water vapor, total ozone, and cloud properties.
10. ACSPO	Multispectral imager retrievals of sea surface temperature.
11. Sounder Quicklook	Quicklook images (maps and Skew-T plots) from CSPP temperature and moisture profile products.

The CSPP SDR and VIIRS EDR software for Suomi NPP is based on the Algorithm Development Library (ADL) developed by Raytheon and the JPSS project. This means that the CSPP software is the same software that runs in the operational processing facility at NOAA/NESDIS. SSEC has packaged the software to run from the Linux command line in real-time direct broadcast mode, however the underlying processing software, algorithms, and data



formats are unchanged. The output files from the CSPP SDR processing software are identical in naming, format, and structure to the corresponding files from NOAA/NESDIS. The native format for NPP SDR products is HDF5, and descriptions of the NPP file formats are available in the “Common Data Format Control Books.”

CSPP also distributes a number of third-party software packages developed by NOAA and the DB community, including the SSEC/CIMSS Dual Regression Retrievals, NOAA Microwave Integrated Retrieval System, and Hydra2 Multispectral Data Analysis Toolkit.

The CSPP project created the following software releases and updates during the reporting period:

- *April 7, 2016: CSPP CLAVRx VIIRS, MODIS and AVHRR Cloud Retrieval Software Version 2.0.*  
Updated release of the NOAA Clouds from AVHRR Extended (CLAVR-x) Retrieval Software Package in support of Suomi-NPP VIIRS, Aqua and Terra MODIS and NOAA-18, NOAA-19, MetOP-A and MetOP-B AVHRR imagers. CLAVRx retrieval software produces a suite of cloud products at single field-of-view resolution. This update includes a new VIIRS nighttime cloud retrieval algorithm that utilizes the Day/Night band lunar reflectances.
- *April 1, 2016: CSPP Suomi NPP CrIS, VIIRS and ATMS SDR Software Version 2.2.*  
New version of the calibration and geolocation Sensor Data Record (SDR) software for the Visible Infrared Imaging Radiometer Suite (VIIRS), Advanced Technology Microwave Sounder (ATMS), and the Cross-track Infrared Sounder (CrIS) instruments that includes an update to the ADL 4.2.11 (IDPS Mx8.11) code base.
- *February 24, 2016: CSPP Advanced Clear-Sky Processor for Oceans (ACSPO) Software Version 1.1.*  
Updated release of the of the NOAA/NESDIS/STAR ACSPO software that retrieves sea surface temperatures from input S-NPP VIIRS, NOAA-15, 16, 17, 18 and 19 and Metop-A and B AVHRR, and Aqua and Terra MODIS imagers. This version (ACSPO 2.40) includes significant upgrades to the sensor-specific error statistics (SSES) algorithm.
- *February 22, 2016: CSPP Suomi NPP HYDRA2 Multispectral Data Analysis Toolkit Version 2.0.*  
New release of the HYDRA2 visualization and analysis toolkit for interrogating JPSS S-NPP, NASA EOS Aqua and Terra instrument data. This toolkit was developed to assist research and development of remote sensing applications as well as education and training of remote sensing scientists. Among other updates, the satellites supported now include NOAA, Metop and FY-3.

## **25.2 Improving Access to Full Resolution VIIRS Imagery in AWIPS**

**CIMSS Task Leaders: Kathleen Strabala, Liam Gumley**

**CIMSS Support Scientists: David Hoese, Ray Garcia, Lee Cronce**

**NOAA Collaborator: Mitch Goldberg**

**Budget: \$50,000**

### **NOAA Long Term Goals:**

- Climate Adaptation and Mitigation
- Weather-Ready Nation



### **NOAA Strategic Goals:**

- Serve society's needs for weather and water
- Understand climate variability and change to enhance society's ability to plan and respond
- Provide critical support for the NOAA mission

### **CIMSS Research Themes:**

- Satellite Meteorology Research and Applications
- Satellite Sensors and Techniques

### **Objective**

The objective of this investigation is to determine the most efficient and robust way for JPSS S-NPP VIIRS full spectral and spatial resolution direct broadcast data to be reprojected and displayed in AWIPS in support of National Weather Service forecasters.

### **Project Overview**

Our aim is to present the full spatial and spectral resolution high quality VIIRS Sensor Data Record (SDR) reflectance and brightness temperature data in the National Weather Service (NWS) visualization and analysis AWIPS toolkit. Several methods have been previously employed to supply S-NPP VIIRS data for display in AWIPS, but these are limited in scope (small subset of bands), spatial resolution (AWIPS full resolution NWP grids are too large for AWIPS display), bit resolution (RGB products have been provided at 8 bit resolution), supported products (for example, no corrected reflectance products available) and timeliness.

### **Milestones with Summary of Accomplishments and Findings**

To date, two separate methods of reaching the goal of high quality full resolution VIIRS images in AWIPS have been employed. The first involves modifying the VIIRS IDPS Imagery EDR software to output all 5 I-Bands and all 16 M-Bands, as opposed to the official product that includes all I-Bands but only 6 M-Bands. The Imagery EDR software was chosen because with a simple modification, the files can be directly displayed in the VIIRS AWIPS-II plug-in at full resolution. The outcome of his effort is a stand alone software package that is portable but not flexible. The Imagery EDR software is complicated and not well documented, which means it was not possible to modify the code in a reasonable amount of time to generate corrected reflectances in the output Ground Track Mercator (GTM) format in order to combine into 24 bit true color imagery. This solution does work, but will not meet all of the project goals during the proposed time period. An example of this technique applied to VIIRS M-Band 11 data from 16 April 2016 is shown in Figure 68, as displayed in AWIPS-II.

The second effort involved creating a stand along simple transformation computer application that will create a bare bones GTM projection AWIPS-II compatible NetCDF file when provided with any VIIRS HDF5 SDRs or VIIRS Corrected Reflectance HDF4 files. This stand alone software creates files that are not identical to VIIRS Imagery EDR files in that they do not include all of the metadata fields, but contain enough information to be accepted and displayed properly by the VIIRS AWIPS-II plug-in.

We have begun work on the development of a third option for displaying full resolution VIIRS data in AWIPS using direct broadcast data. This work utilizes the CSPP VIIRS Polar2Grid (P2G) software package for efficiently and easily creating high quality reprojections. The idea is to break down the individual AWIPS grid file currently used for 1km reprojection and display in AWIPS, into finer scale tiles at full resolution. The current limitation at 1km resolution is the



output VIIRS reprojected grid file sizes. By breaking down the grid into smaller tiles, and with the new capabilities of AWIPS-II, we should be able to write efficient software with the logic to create the tiles at the antenna site and re-assemble the tiles on the AWIPS client side. This work will be completed by the end of the funding period. At the end of this process, the best method will be chosen and implemented in Wisconsin, at the SSEC for support of CONUS forecasters, and then in Alaska and the Pacific region for support of OCONUS forecast offices.

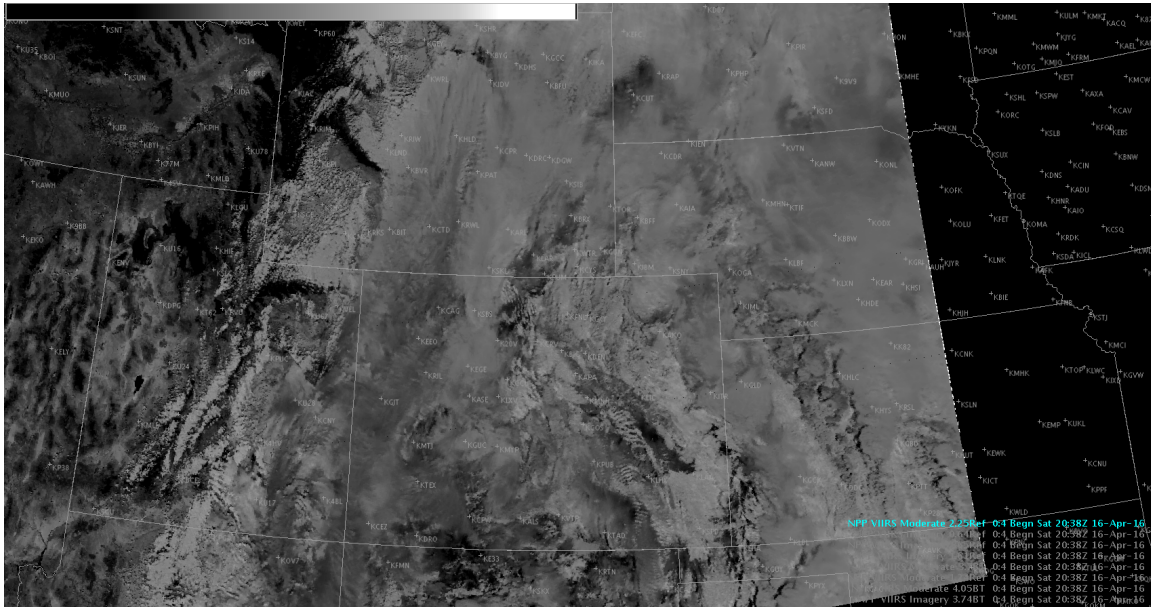

**Figure 68. VIIRS M-Band 11 (2.25 micron) reflectance full resolution (740 m) image as displayed in AWIPS-II. The image was created using direct broadcast data acquired and processed at UW-Madison/CIMSS/SSEC using modified VIIRS Imagery EDR software. This band is currently not produced by the operational Imagery EDR software, and is therefore not available to forecasters using the AWIPS-II plug-in at this time. It is useful for snow and ice discrimination as well as cloud microphysical property identification.**

### **Publications and Conference Reports**

Hoese, D., K. Strabala, L. Gumley, H.-L. Huang and R. Garcia, *Polar2Grid Version 2.0: Reprojecting VIIRS Satellite Data Made Easy*. 96<sup>th</sup> AMS Annual Meeting, 14 January 2016, New Orleans, LA.

### **25.3 GOES-R Support for International TOVS Study Conference (ITSC-20)**

**CIMSS Task Leader: Allen Huang**  
**NOAA Collaborator: Mitch Goldberg**  
**Budget: \$20,000**

#### **NOAA Long Term Goals:**

- Weather-Ready Nation

#### **NOAA Strategic Goals:**

- Serve society's needs for weather and water
- Provide critical support for the NOAA mission

#### **CIMSS Research Themes:**

- Education and Outreach



## Objective

The objective of this was to provide partial support for the ITSC-20 Conference to be held in Lake Geneva, Wisconsin in 2015. The funding supported the conference organization efforts at CIMSS and also support the publication of the Working Group Report and an update to the ITWG Web pages regarding conference activities.

## Milestones with Summary of Accomplishments and Findings

The International TOVS Working Group (ITWG) is convened as a sub-group of the International Radiation Commission (IRC) of the International Association of Meteorology and Atmospheric Physics (IAMAP). The ITWG organizes International TOVS Study Conferences which have met approximately every 18 months since 1983. The most recent conference, the Twentieth International TOVS Study Conference (ITSC-20) was held in Lake Geneva, Wisconsin in November 2015.

Through the ITWG forum operational and research users of TOVS/ATOVS/AIRS/IASI and other atmospheric sounding data have exchanged information on data processing methods, derived products, and the impacts of radiances and inferred atmospheric temperature and moisture fields on numerical weather prediction, and weather and climate studies.

The conferences include oral and poster presentations, and the formation of working sub-groups to discuss issues and provide actions and recommendations to share with the international community in the following areas important to the science:

- Radiative Transfer and Surface Property Modelling,
- ATOVS/TOVS and other Sounder Data in Numerical Weather Prediction,
- Satellite Sounder Science and Products,
- TOVS/ATOVS in Climate Studies,
- Advanced Infrared Sounders, and
- International Issues and Future Systems.

There are also technical sub-groups which meet informally to co-ordinate ATOVS and EOS direct broadcast processing software, radiative transfer models and frequency protection issues relevant to the ITWG community.

The conference Working Group Report summarizes the recommendations and actions of these working groups. Technical Proceedings of the scientific presentations and posters are also published. The ITWG web site (<http://cimss.ssec.wisc.edu/itwg/>) contains electronic versions of the conference papers, presentations and posters. Together, these documents and web pages reflect the conduct of highly successful international meetings.

This funding provided partial resource to conduct the 20<sup>th</sup> ITSC in Lake Geneva, WI on 28 October - 3 November 2015. The agenda and presentations from this meeting are located at: <https://cimss.ssec.wisc.edu/itwg/itsc/itsc20/program/>

Over 200 participants attended the Conference from 35 organizations, providing a wide range of scientific contributions. Fifteen countries and three international organizations were represented: Brazil, Canada, China, Taiwan, France, Germany, India, Japan, Norway, Russia, South Korea, Sweden, Switzerland, United Kingdom, United States, ECMWF, EUMETSAT, and the WMO. For the fourth successive meeting the number of attendees broke the record for the highest ever attendance. The Working Groups had very productive discussions and it was again encouraging



to see a large number of new, younger scientists participating. This was the first time that ITWG met formally as sub-group of CGMS, and the group warmly appreciated this formal recognition, while continuing the important ties with the International Radiation Commission (IRC).

## **25.4 Assessing the Impact of Assimilating Clear and Cloudy Sky CrIS Radiances in a Regional-scale Ensemble Data Assimilation System**

**CIMSS Task Leader: Jason Otkin**

**Budget: \$60,000 (FY16)**

### **NOAA Long Term Goals:**

- Weather-Ready Nation

### **NOAA Strategic Goals:**

- Serve society's needs for weather and water

### **CIMSS Research Themes:**

- Satellite Meteorology Research and Applications
- Environmental Models and Data Assimilation

### **Objective**

The primary objective of this project is to explore the impact of assimilating clear and cloudy sky infrared brightness temperatures in a regional-scale ensemble data assimilation system.

### **Project Overview**

For this project, high-resolution assimilation experiments will be performed using the COSMO numerical weather prediction model (Baldauf et al. 2011) and the KENDA ensemble data assimilation system (Schraff et al. 2016) being developed by the German Deutscher Wetterdienst (DWD). These experiments will assess the impact of assimilating clear and cloudy sky infrared radiances from the CrIS sensor onboard the Suomi NPP satellite and from the SEVIRI sensor (Schmetz et al. 2002) onboard the MSG satellite. Because the KENDA system will become operational at the DWD in 2017, the proposed experiments provide a valuable opportunity to examine the impact of assimilating all-sky infrared brightness temperatures within an operational ensemble data assimilation system run over a regional-scale domain.

Assimilation experiments will be performed for a select case study on the COSMO\_DE domain that covers most of central Europe with 2.8-km horizontal resolution. The experiments will focus on assimilating observations from the water vapor sensitive infrared bands given their more Gaussian error characteristics. Before the brightness temperatures can be assimilated, however, it will first be necessary to develop a bias correction scheme suitable for both clear and cloudy sky observations because prior work has shown that observation-background bias errors can vary for different cloud types. Thus, to effectively assimilate cloud-affected infrared radiances, a bias correction scheme should account for potential cloud-dependent error relationships instead of simply applying uniform bias corrections to all cloudy observations regardless of cloud type.

### **Milestones with Summary of Accomplishments and Findings**

- *Install KENDA system on the S4 supercomputer*  
During the first stage of the project, substantial efforts were undertaken to port the entire KENDA system to the S4 supercomputer located at the University of Wisconsin-Madison. This included compiling the COSMO model, the RTTOV radiative transfer





model, the local ensemble transform Kalman filter (LETKF) that performs the data assimilation, and numerous supporting libraries, such as the GRIB\_API and the DWD GRIB libraries. In addition, substantial modifications were made to the basic cycling (BACY) scripts provided by the DWD to perform the data assimilation experiments. This was necessary because of vastly different job submission environments and directory structures. Numerous tests were subsequently performed to ensure that the assimilation system was working correctly.

- *Passive monitoring of cloud-dependent satellite observation errors*  
After installing the KENDA system, several assimilation experiments in which clear and cloudy-sky infrared brightness temperatures were passively monitored were performed for a 5-day period from 16-21 May 2014. This period contained a wide array of cloud types and weather regimes and thus serves as a good case study to assess if cloud-dependent observation errors are present in the simulated data. Sensitivity tests are currently being performed to evaluate errors in the simulated brightness temperatures for the 6.2 and 7.3  $\mu\text{m}$  water vapor sensitive bands when different cloud habits and ice content to effective diameter equations are used by the RTTOV model when computing the simulated brightness temperatures. Preliminary results show that the error statistics can change rapidly with time due to changes in the prevailing cloud regime. Results from these sensitivity tests will be used to identify which RTTOV settings produce the most accurate simulated brightness temperatures. Methods will then be developed to account for cloud-dependent observation biases in the data prior to their assimilation.

## References

Baldauf M, A. Seifert, J. Forstner, D. Majewski, M. Raschendorfer, T. Reinhardt T, 2011: Operational convective-scale numerical weather prediction with the COSMO model: Description and sensitivities. *Mon. Wea. Rev.*, **139**, 3887-3905.

Schraff, C., H. Reich, A. Rhodin, A. Schomburg, K. Stephan, A. Perianez, and R. Potthast, 2016: Kilometer Scale Ensemble Data Assimilation for the COSMO Model (KENDA). Accepted for publication in the *Quarterly Journal of the Royal Meteorological Society*.

## 25.5 JPSS Support for Direct Readout Site at University of Puerto Rico-Mayaguez

**CIMSS Task Leader: Liam Gumley (PM)**

**NOAA Collaborator: Mitch Goldberg**

**Budget: \$30K**

### NOAA Long Term Goals

- Weather-Ready Nation

### NOAA Strategic Goals

- Serve society's needs for weather and water
- Provide critical support for the NOAA mission

### CIMSS Research Themes

- Satellite Meteorology Research and Applications
- Satellite Sensors and Techniques

### Objective

To continue to support and JPSS Puerto Rico antenna installation.



## Project Overview

CIMSS/SSEC at UW-Madison is responsible for installing turnkey X/L-band polar orbiting satellite receiving stations at (a) the NOAA Atlantic Oceanic and Meteorological Laboratory (AOML) in Miami, Florida and (b) the Tropical Center for Earth and Space Studies at the University of Puerto Rico-Mayaguez (UPRM) under NOAA funding obtained via a Hurricane Sandy Supplement grant. The primary purpose of the antenna systems is to provide real-time infrared and microwave sounder data NOAA to support rapid data assimilation for NOAA/NCEP operational numerical weather prediction models. CIMSS/SSEC is managing the procurement and installation of the antenna systems at the two host sites, and will operate the stations remotely. In return for providing a host location for the antenna systems, NOAA AOML and UPRM will have full access to all data collected by the systems, including Level 0/1/2 and derived products, via a HTTP interface. NOAA will establish the reception priorities (Metop and SNPP will be at the highest priority) and SSEC will set the reception schedule to acquire data from these satellites, and any other satellites at lower priority as determined jointly by NOAA, CIMSS/SSEC, and AOML or UPRM. The complete list of satellites supported by the antenna systems will include Metop A/B, Suomi NPP, POES, Terra, Aqua, and FY-3 A/B. CIMSS/SSEC will provide a production generation server as part of the installed hardware to create satellite products in real-time. The host locations (AOML and UPRM) will provide the necessary network resources to enable the infrared sounder (CrIS and IASI) and microwave sounder (ATMS and AMSU) data to be sent back to SSEC (and hence to NOAA) with acceptable latency. The AOML station was successfully installed and commissioned in September 2014. The UPRM station will be installed in June 2015. This proposal seeks funding for personnel to provide support for the antenna system in the first year of operation, in order to ensure reliable system operation and remote diagnosis and testing in the event of system anomalies.

## Implementation Approach

This request seeks funding for an operator to support the UPRM antenna operations, maintenance, diagnosis, and data processing. Tasks expected to be supported by the system operator include:

- Daily monitoring of antenna system expected and actual performance,
- Adjusting satellite reception schedules when requested by CIMSS/SSEC,
- Daily monitoring of computer system health and status,
- Reporting of system problems to CIMSS/SSEC and/or antenna vendor as appropriate,
- Daily monitoring of product generation on the local processing system,
- Daily monitoring of Level-0 data delivery to CIMSS/SSEC,
- Daily monitoring of imagery products to the National Weather Service office in San Juan PR,
- Coordinating hardware support with local vendors as needed for repairs or upgrades,
- Coordinating with UPRM IT security and network managers to ensure reliable and secure system operation, and
- Monthly hardware inspections.

Having a system operator will ensure that the system successfully meets its' goal of providing reliable low latency infrared and microwave sounder data to NOAA for NWP. It will also assist in providing imagery from the JPSS satellites to the local NWS forecasters in Puerto Rico without taxing the limited bandwidth available from the NWS forecast office to the United States.

This funding resource is in the process of a subcontract implementation to provide local maintenance support at UPRM.



## **25.6 The Development of ISEE: An “Innovative Satellite Enhancement Exploration”**

**CIMSS Task Leader: Sam Batzli**

**CIMSS Support Scientists: Allen Huang, Dave Parker, Nick Bearson, Russ Dengel,  
Tommy Jasmin**

**NOAA Collaborator: Mitch Goldberg**

**Budget: \$168K**

### **NOAA Long Term Goals:**

- Climate Adaptation and Mitigation
- Weather-Ready Nation

### **NOAA Strategic Goals:**

- Serve society’s needs for weather and water
- Understand climate variability and change to enhance society’s ability to plan and respond
- Provide critical support for the NOAA mission

### **CIMSS Research Themes:**

- Satellite Meteorology Research and Applications
- Education and Outreach

### **Objective**

To extend the awareness, knowledge, and understanding of the societal value of JPSS satellites.

### **Project Overview**

ISEE is a web page and native mobile app that will monitor environmental events and conditions observed by S-NPP/JPSS satellites in near real-time, based on user-defined locations and subjects. The app will notify the user of a noteworthy event, display it on their mobile device, and extend a social media capability for sharing the discovered event with Twitter, Facebook, Email, or others.

### **Milestones with Summary of Accomplishments and Findings**

Milestone 1: Identify and develop flow of current S-NPP/JPSS operational products.

During this year, developers worked on creating the flow of current S-NPP/JPSS satellite imagery products for automated “newest-image” display in the RealEarth desktop browser environment. Establishing the automated processes that build imagery products is a critical step in the development of ISEE. It is from these data that we will develop the display and notification elements of ISEE in the mobile devices. Several products are now available for viewing, including the following:

#### **True and False Color:**

- NPP Land Surface True Color (GLOBALnpptc)
- NPP True Color (npptc)
- NPP False Color (nppfc)

#### **Day/Night Band:**

- NPP VIIRS Day/Night Band Composites (Day) (nppdnb-day)
- NPP VIIRS Day/Night Band Composites (Night) (nppdnb-night)

#### **IR Bands:**

- NPP VIIRS Near Infrared Composites (Day) (nppnir-day)



- NPP VIIRS Short Wave Infrared Composites (Day) (nppswir-day)
- NPP VIIRS Short Wave Infrared Composites (Night) (nppswir-night)
- NPP VIIRS Long Wave Infrared Composites (Day) (npplwir-day)
- NPP VIIRS Long Wave Infrared Composites (Night) (npplwir-night)

**Visible:**

- NPP VIIRS Visible-1 Composites (Day) (nppvis1-day)
- NPP VIIRS Visible-2 Composites (Day) (nppvis2-day)

**Metadata:**

- NPP Orbit tracks (POESNAV-NPPtrack)
- NPP Orbit times (POESNAV-NPPpoint)

**Derived Products:**

- NPP Sea Surface Temperature (nppsst)
- VIIRS Satellite Detected Fire Locations (VIIRSFire)
- Global Black Marble (VIIRS-MASK-54000x27000) – static
- Total Column Sulphur Dioxide (AURA-SO2) – for future comparison to NPP

Any of these products can be visualized in the RealEarth web mapping browser in any combination and order, with or without transparency. For example, VIIRS Active Fires can be overlaid on NPP True Color (Figure 69) then shared with a short URL like this:

<http://realearth.ssec.wisc.edu:80/s/uaYAq>

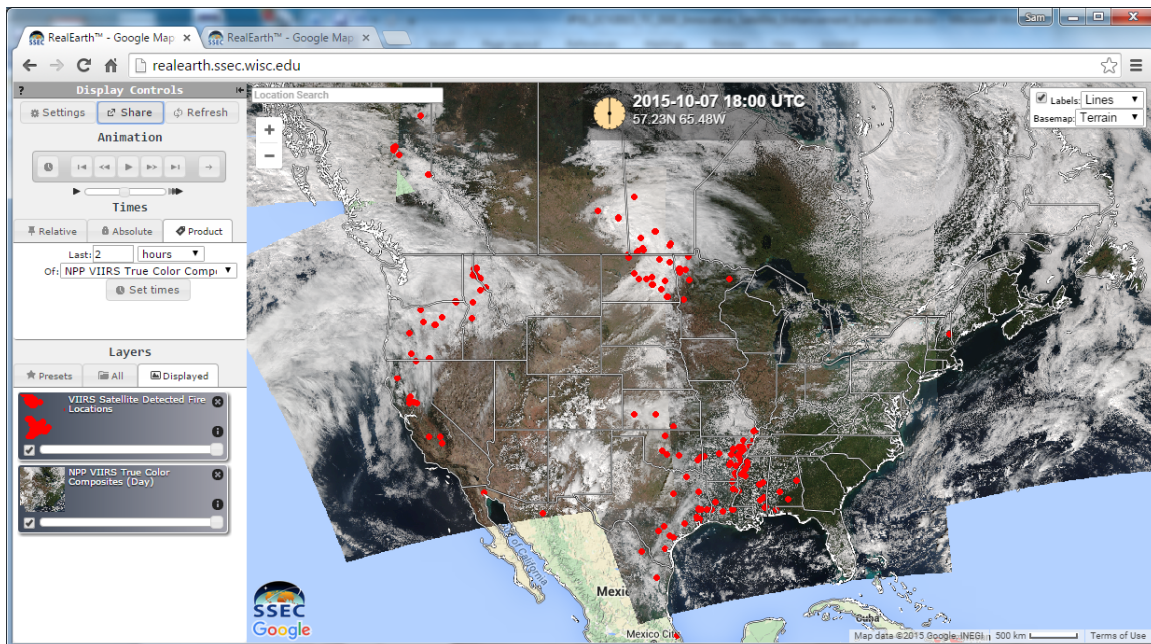

**Figure 69. RealEarth browser display of daily S-NPP VIIRS True Color Composite with VIIRS Satellite Detected Fire Locations (newest available) from VIIRS Active Fire team at University of Maryland (<http://viirsfire.geog.umd.edu/>).**

**Milestone 2: Identify and implement initial customizations for ISEE-specific, JPSS-branded browser interface from dedicated VM.**

The modular design of the RealEarth system of virtual machines (VMs) makes it easy to spin-up a dedicated processing system for visualization. Each VM includes all the components necessary to support visualization of satellite imagery and data products in both a unique browser and corresponding mobile apps. Our technical computing team is in the process of installing two new servers in support of the larger RealEarth system. These new servers will host the RealEarth head



node VMs that direct traffic, balancing the load and distributing jobs to the appropriate VMs. These new servers will free-up space on one of our current servers. Once the new head nodes are in place, we will spin-up a new VM dedicated to ISEE product visualization with its own customized RealEarth browser. It will be branded with the JPSS and ISEE logos. By the end of November, we expect to have the dedicated ISEE VM up and running with the products listed above transferred over to it.

Milestone 3: Open ISEE Browser to beta testers at SSEC, NOAA NESDIS and PGRR program managers.

Milestone 3 follows directly from Milestone 2 and will mark the soft-release of the ISEE web browser for beta testers at the end of the next reporting period.

Milestone 4: Identify and develop flow of S-NPP/JPSS research products in RealEarth.

Milestone 4 is ongoing and in progress. As new products become available, the team adds them to the RealEarth processing stream.

Milestone 5: Offer beta version of iOS and Android Apps for testing with SSEC and NOAA NESDIS personnel.

The team has some early progress to report a little ahead of schedule on Milestone 5. The development team has begun the early design phase of the ISEE App. In meetings regarding the RealEarth/ISEE browser component and the mechanisms that we will use to generate notifications of events through the mobile app, the team decided it would be useful to start the ISEE App design process. This has resulted in a very early basic functional prototype for the product selection and display elements of the app. Here is an example showing VIIRS Active Fires and NPP True Color on an iPhone. Note the user's location is indicated with the blue dot. Fires are indicated in red. Bringing these two kinds of components together (the location of an environmental event – in this case fires, and the user's location) demonstrate how potentially valuable the mobile apps will be, even with this simple example (Figure 70). When the notification capability is added for pre-selected events and user locations, and social media sharing is enabled, the power of this tool will expand tremendously.



Figure 70. ISEE iOS Prototype App display of daily S-NPP VIIRS True Color Composite with VIIRS Satellite Detected Fire Locations (newest available) from VIIRS Active Fire team at University of Maryland (<http://viirsfire.geog.umd.edu/>). This is an actual screenshot from an iPhone 5s.

## 25.7 Incorporating the GMU Flood and CCNY Ice Products Algorithms into the CSPP

**CIMSS Task Leader:** Jay Hoffman

**CIMSS Support Scientists:** David Santek, Russell Dengel

**Budget:** \$60,000

### NOAA Long Term Goals:

- Weather-Ready Nation

### CIMSS Research Themes:

- Satellite Meteorology Research and Applications
- Satellite Sensors and Techniques

### Objective

Evaluation and maintenance of the routine generation of the GMU flood and CCNY ice products at CIMSS.

### Project Overview

CIMSS hosts a river ice product developed at City College of New York (CCNY) and a river flood product



developed at George Mason University (GMU), both product algorithms are derived from VIIRS. The GMU product provides an estimate of flooding water fractions, regions of ice, cloud, snow cover, and shadows. The CCNY algorithm produces an enhanced river ice mapping product with river ice location, extent, and concentration. Products are generated with direct broadcast VIIRS data in near real-time and sent to AWIPS and for those without access to AWIPS - SSEC's RealEarth Web Map Service. The success of the product has sparked interest from several river forecast centers (APRFC, NERFC, MBRFC, and WGRFC). These products could be useful to other institutions that monitor river ice and flooding conditions, especially in mid- and high-latitude locations.

## **Milestones with Summary of Accomplishments and Findings**

### ***Maintenance of CCNY's River Ice Algorithm***

The CIMSS CSPP team is generating this product routinely and providing it to NWS River Forecast Centers (RFC). During the reporting period, CCNY did not deliver any product changes to CIMSS, however CIMSS is anticipating the imminent delivery of an algorithm update that will increase the number of ice classes. The product has run routinely at CIMSS, however, a hardware problem at the Geographic Network of Alaska (GINA) caused an extended product interruption. After a re-installing the software on new GINA hardware, the product is once again on-line. The CCNY river ice product is displayed in AWIPS and RealEarth through the following links:

- Alaska: <http://realearth.ssec.wisc.edu/?products=RIVER-ICE-AP>
- Missouri Basin: <http://realearth.ssec.wisc.edu/?products=RIVER-ICE-MB>
- North Central: <http://realearth.ssec.wisc.edu/?products=RIVER-ICE-NC>
- North East: <http://realearth.ssec.wisc.edu/?products=RIVER-ICE-NE>

### ***Maintenance of GMU's River Flood Algorithm***

GMU delivered a product update to CIMSS. The product is running routinely at CIMSS; the same hardware outage at GINA that interrupted ice product generation in Alasaka also interrupted the flood product. After a re-installation, the product is running routinely on the GINA hardware. The product is displayed in AWIPs and RealEarth (Figure 71) through the following links:

- US: <http://realearth.ssec.wisc.edu/?products=RIVER-FLDall-US>
- Alaska: <http://realearth.ssec.wisc.edu/?products=RIVER-FLDall-AP>
- Missouri Basin: <http://realearth.ssec.wisc.edu/?products=RIVER-FLDall-MB>
- North East: <http://realearth.ssec.wisc.edu/?products=RIVER-FLDall-NE>
- North Central: <http://realearth.ssec.wisc.edu/?products=RIVER-FLDall-NC>
- West Gulf: <http://realearth.ssec.wisc.edu/?products=RIVER-FLDall-WG>

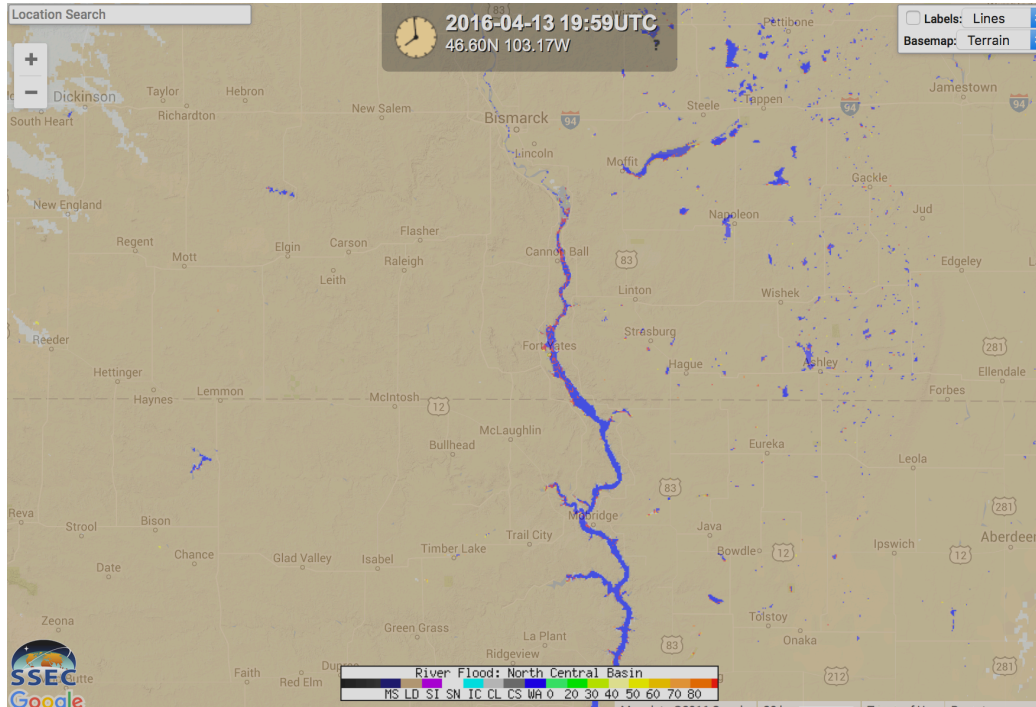

Figure 71. Example of the flood product for 13 April 2016 at 1959 UTC for the Missouri River. The majority of the river is open water (blue); shades of red indicate potential flooding areas.

Working with the RealEarth development group, CIMSS has developed a new flood notification tool as shown in Figure 72. The tool allows a subscribed user to use map drawing tools to define a region of interest and receive email notifications whenever the user-defined flood conditions are detected.

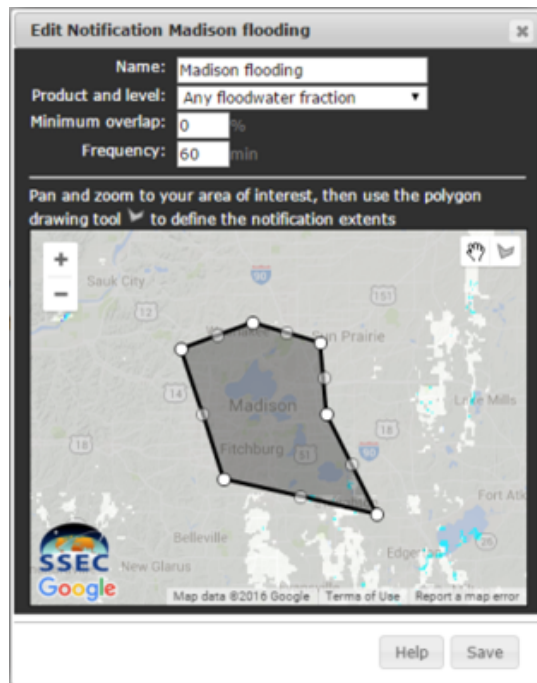

Figure 72. Example of flood notification tool in RealEarth used to define conditions that will generate email notifications.





### **Software Evaluation**

There are challenges in the possible future effort to transition the code into the CSPP package. The software packages require a significant amount of time and storage resources to process the VIIRS granules. Additionally, the algorithms use licensed software packages (Matlab, IDL) that will need to be removed to be packaged in the CSPP. Algorithm developers are still developing product updates; a transition to CSPP will not be worthwhile while algorithm development is still ongoing.

### **Publications and Conference Reports**

Santek, D., S. Li, N. Chaoch, J. Gerth, J. Hoffman, P. Alabi, (2015). Real-time generation of river ice and flood products derived from VIIRS imagery. CSPP/IMAPP Users' Group Meeting, Eumetsat, Darmstadt, Germany, 14-16 April 2015.

### **References**

Chaouch, N., M. Temimi, P. Romanov, R. Cabrera, G. Mckillop, R. Khanbilvardi. (2014). An Automated Algorithm for the Monitoring of River Ice over the Susquehanna River Basin using MODIS data. Hydrol. Process.. 28, Issue: 1, 62-73.

Li, S., D. Sun, M. Goldberg, A. Stefanidis (2013). Derivation of 30-m-resolution Water Maps from TERRA/MODIS and SRTM. Remote Sens. Environ. 134, 417–430.

Li, Sanmei, DonglianSun, YunyueYu, Ivan Csiszar, Antony Stefanidis, & Mitch D. Goldberg (2012). A New Shortwave Infrared (SWIR) Method for Quantitative Water Fraction Derivation and Evaluation with EOS/MODIS and Landsat/TM data. IEEE Transactions on Geoscience and Remote Sensing, 51, Issue 3.

Sun, D. L., W. Zheng, S. Li, and M. Goldberg, 2015: Mapping Flood Induced by Hurricane Storm Surge Using the NPP/JPSS ATMS Data, AMS annual meeting, January 04 - 08, 2015, Phoenix, AZ.

## **26. SSEC/CIMSS Participation on the Algorithm Development Library (ADL) Team**

**CIMSS Task Leader: Liam Gumley**

**CIMSS Support Scientist: Scott Mindock, Ray Garcia, Graeme Martin**

**NOAA Collaborator: Pat Purcell**

**Budget: \$359K**

### **NOAA Long Term Goals**

- Weather-Ready Nation

### **NOAA Strategic Goals**

- Serve society's needs for weather and water
- Provide critical support for the NOAA mission

### **CIMSS Research Themes**

- Satellite Meteorology Research and Applications
- Satellite Sensors and Techniques



## Objective

SSEC/CIMSS supports the JPSS Project by providing a public release point for the Algorithm Development Library, ensuring that all users inside and outside JPSS have access to the latest version of ADL and can download, install, and run the ADL system.

## Project Overview

SSEC supports the JPSS project as a member of the Algorithm Development Library (ADL) Team by

- Acting as the release point for ADL to the JPSS user community,
- Maintaining the ADL Website and User Forum,
- Providing user support for installing and operating ADL,
- Providing training material and courses for end users of ADL,
- Developing a Docker-based distribution of ADL,
- Developing an ingest and pre-processing capability for dynamic ancillary data in ADL,
- Verify compatibility with RDRs from Direct Broadcast sources,
- Check compatibility of Direct Broadcast produced SDRs with the corresponding IDPS SDRs, and
- Verify robustness of ADL distributions before public release.

SSEC works closely with the Raytheon ADL development team and the JPSS project to ensure that ADL meets the needs of users who wish to execute and modify IDPS PRO algorithms outside the operational IDPS environment.

## Milestones with Summary of Accomplishments and Findings

SSEC provided support to the JPSS community for ADL 4.2 and ADL 5.0 during 2015. The JPSS MX builds associated with this release included 5.8.06 (Feb 2015) to 5.8.11 (Jan 2016) and Block 2 releases to 2.0.00.00.16 (March 2016). Each of these MX releases initiated several activities at SSEC. These activities included:

- Staging of ADL release DVD contents;
- Updates of installation scripts for ADL and COTS;
- Testing of installation scripts on several platforms;
- Updates to ADL installation instructions including COTS version updates;
- Building and testing ADL using a variety of compiler versions on supported platforms;
- Identification and ingest of ancillary data required for SDR algorithms, including calibration LUTs;
- Improvements to ancillary ingest QC; and
- A CSPP SDR version based on ADL 4.2 mx 5.8.11 was developed and tested, and released in early April 2016.

SSEC provided distribution of ADL and end-user support at <https://jpss.ssec.wisc.edu/> (Figure 73). The ADL website includes information on ADL Software and Downloads, Installation Instructions, Scripts and Helper Applications, ADL Virtual Appliance, HOWTOs, Add-Ons, and a link to the ADL help desk email address. The website also contains links to the ADL ancillary data website.

SSEC continued to host and support the online ADL User Forum available at <https://forums.ssec.wisc.edu/viewforum.php?f=23> (Figure 74). The ADL forum allows ADL users to interact directly with the development team, and each other, with or without the involvement of SSEC. Raytheon has proven to be especially helpful and diligent in monitoring and answering ADL user questions on the forum site.



SSEC continued to operate a real-time ancillary data ingest and distribution site to provide a one-stop shop for ADL users to obtain the ancillary data needed to run SDR and EDR algorithms. The website is available at <http://jpssdb.ssec.wisc.edu/ancillary/>

Files distributed include:

- GFS model grib2 forecast files,
- GDAS model grib2 analysis files,
- NISE Snow and Ice Extent HDF4 files,
- NAAPS aerosol forecast grib2 files,
- Polar Wander blob and ascii files,
- TLE internal text and ascii files, and
- LUTs needed for SDR processing.

The screenshot shows a web browser window with the address bar at [download.ssec.wisc.edu](http://download.ssec.wisc.edu). The page title is "SSEC Downloads". Below the header, there is a note: "Download ADL software - NOTE: All ADL software is distributed under the [GNU Public License Agreement](#) unless otherwise specified." A table lists various download items with corresponding links:

ADL Workshop Materials	<a href="#">ADL 4.2 Workshop Materials</a>
JPSS ADL Software - RAYTHEON - ADL Version 4.2	<a href="#">ADL DVDs</a>
JPSS ADL Software - RAYTHEON - ADL Version 5.x	<a href="#">ADL DVDs</a>
ADL Manual Part 1	<a href="#">ADL_BLOCK2_Pt1.docx</a>
ADL Manual Part 2	<a href="#">ADL_BLOCK2_Pt2.docx</a>
Release Notes	<a href="#">README_ADL.txt</a>
ADL and COTS Installation instructions	<a href="#">ADL_Cots_Installation.pdf</a>
COTS Installation Scripts - UW Madison, SSEC - Use command below to retrieve all support scripts (recommended)	<a href="#">ADL support scripts</a>
<code>wget --no-check-certificate -t 5 -T 15 -r -l -l -nH -nd -c -A *.sh https://jpss.ssec.wisc.edu/jpss-data/httpsFiles/SSEC-Support/ADL4.2/scripts</code>	
Download and install the COTS required for ADL 4.2. Run it or use it as a reference.	<a href="#">adl_cots_install.sh</a>
Science Appliance - UW Madison, SSEC; Reference build of ADL packaged in VMWare virtual appliance User: RH6B pw: RH6B! NOTE: The appliance is not supported with Block 2 beta	<a href="#">ADL Virtual Appliance</a>
COTS - Various Providers	<a href="#">all COTS</a>

At the bottom of the page, there is a link: "Problems with the website? [Contact the webmaster](#)"

Figure 73. SSEC ADL Website showing ADL installation instructions.



**JPSS CGS Algorithm Development Library**

ADL

FORUM	TOPICS	POSTS	LAST POST
<b>Announcements</b>	24	25	by scottm Mon Jan 25, 2016 10:27 am
<b>Installation</b> Issues related to installation of ADL	71	333	by thalamusinc Fri Apr 01, 2016 4:25 pm
<b>Runtime</b> Issues related to runtime execution of algorithms in ADL	35	200	by ronrogers Mon Mar 14, 2016 11:27 pm
<b>Input and Output</b> Data formats, HDF5, XML profiles, etc.	70	352	by besteyelash Sat Apr 02, 2016 12:23 pm
<b>VIIRS SDR</b> Issues related to the VIIRS SDR algorithm and data	17	96	by houchin Mon Aug 17, 2015 8:01 am
<b>VIIRS EDRs</b> Issues related to VIIRS EDR algorithms and data	43	276	by justinjcruz Sat Mar 12, 2016 4:23 am
<b>CrIS SDR</b> Issues related to the CrIS SDR algorithm and data	5	24	by bhenders Wed May 22, 2013 10:54 am
<b>ATMS SDR</b> Issues related to the ATMS SDR algorithm and data	3	7	by rantisat Mon Dec 14, 2015 9:01 pm
<b>CrIMSS EDR</b> Issues related to the CrIMSS EDR algorithm and data	1	5	by aunfci Sun Nov 30, 2014 2:00 am
<b>XML Editor</b>	2	9	by freedytom Sat Oct 10, 2015 1:31 am
<b>OMPS SDR</b>	2	5	by tsimpson Tue Oct 14, 2014 11:53 am
<b>OMPS EDR</b>	0	0	No posts

NEWTOPIC\* Search this forum... Search 0 topics • Page 1 of 1

There are no topics or posts in this forum.

Display topics from previous: All Topics Sort by Post time Descending Go

Return to Board index Jump to: ADL Go

Figure 74. SSEC Forum for ADL.

## 27. CIMSS Visiting Scientist on Tropical Cyclone Monitoring and Predicting with Satellite Measurements

CIMSS Task Leader: Jun Li

CIMSS Support Scientist: Hyojin Han

NOAA Collaborator: Mitch Goldberg

Budget:

### NOAA Long Term Goals:

- Climate Adaptation and Mitigation
- Weather-Ready Nation



### **NOAA Strategic Goals:**

- Serve society's needs for weather and water
- Understand climate variability and change to enhance society's ability to plan and respond
- Support the nation's commerce with information for safe, efficient and environmentally sound transportation
- Provide critical support for the NOAA mission

### **CIMSS Research Themes:**

- Satellite Meteorology Research and Applications
- Satellite Sensors and Techniques
- Environmental Models and Data Assimilation

### **Objective**

The objective is to study the better use of microwave data from JPSS for NWP.

### **Project Overview**

In order to understand the better use of satellite data for tropical cyclone (TC) forecasts, a Postdoc scientist is proposed to work at the Cooperative Institute for Meteorological Satellite Studies (CIMSS) at the University of Wisconsin-Madison on the application of S-NPP/JPSS sounder (CrIS, ATMS) data for Hurricane and Typhoon forecast improvement, CIMSS Satellite Data Assimilation for Tropical Storm forecasts (SDAT) with domain over Pacific Ocean will be used as the testbed, focus will be on the use of dynamic and thermodynamic information from S-NPP/JPSS for Typhoon Haiyan (2013) forecast improvement. Since Typhoon Haiyan is considered the strongest landed Typhoon even in the history; this research is expect to maximize the benefit of satellite data in monitoring and predicting strong TCs such as Haiyan (2013).

### **Milestones with Summary of Accomplishments and Findings**

#### ***GPM Assimilation Tested with SDAT as Testbed (July 2015 – December 2016)***

Follow guidance from Dr. Mitch Goldberg, we have started the assimilation of GPM data, the purpose is to evaluate the relative impact of advanced IR sounders, advanced microwave sounders and GPM on tropical cyclone impact. GPM data will provide detailed 3D information on atmospheric water (vapor, cloud and precipitation) over vast regions of the ocean, which is important in understanding and predicting the genesis, intensity, movement, rainfall potential, and landfall impacts of tropical weather systems, particularly hurricanes. Although satellite data have been used by NWP centers for decades and have shown positive impact on global weather forecasting (Le Marshall et al. 2006; McNally et al. 2006), most information provided by these data for TC forecasting comes from the surrounding environment, due mainly to the limited use of both IR and microwave sounding data in cloudy regions by most data assimilation systems. Incorporating greater information in precipitating areas from GPM data, especially within the TC inner core, may help to improve intensity forecasts (Zhang et al. 2013). Demonstrating the value-added impact of assimilating GPM data in all-sky conditions on TC forecasts is therefore of keen interest to both research and operational communities and is an essential goal of this study.

Initial work has been done on converting the GPM rainrate into BUFR format that GSI can assimilate (see Figure 75). Initial testing shows slight positive impact from adding GPM rain rate to GTS data. Works are ongoing on optimal assimilation schemes/strategies for GPM data assimilation including direct assimilation of GMI. After assimilate schemes have set up, impact studies on CrIS, ATMS, and GPM will be conducted on top of GTS data.

### GPM Rain Rate Assimilation

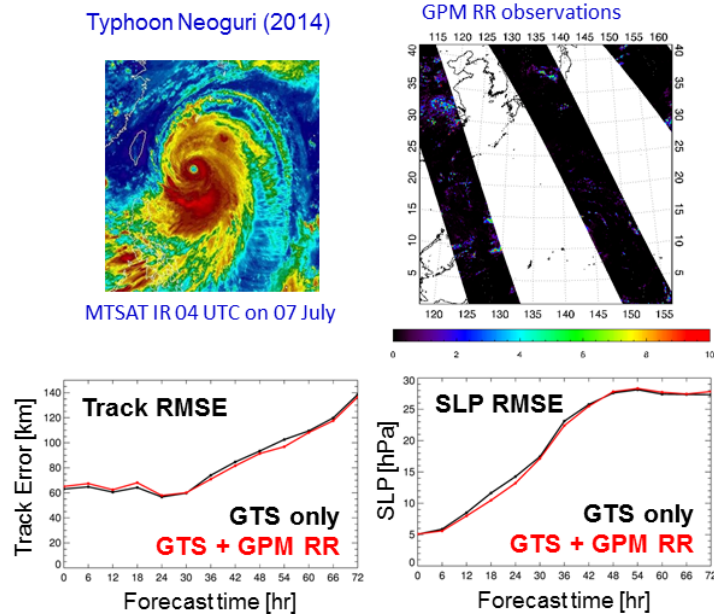

Figure 75. IR image at 04 UTC (upper left), GPM rainrate measurements at 06 UTC (upper right) on 07 July 2014 for Typhoon Neoguri. Track (lower left) and central sea level pressure (SLP) forecast RMSE from 06 UTC 04 July valid to 00 UTC 06 July, 2014. Eight groups of forecasts (updated every 6 hours) are included in the statistics.

### ***Improved ATMS Cloud Screening with Collocated VIIRS Cloud Mask for Radiance Assimilation (October 2015 – February 2016)***

Cloud screening is one of the most important steps in microwave sounder radiance assimilation. Since microwave and VIS/IR sense clouds quite differently, it is necessary to study on how to use VIIRS cloud properties to screen out clouds in microwave sounder radiances. To improve ATMS radiance assimilation for tropical cyclone (TC) forecasts, ATMS measurements are collocated with high spatial resolution VIIRS cloud products (cloud mask, cloud optical thickness, cloud-top height), and the cloud-screened ATMS radiance measurements are assimilated for Hurricane Sandy (2012) and Typhoon Haiyan (2013) forecasts using SDAT as testbed. It is found that cloud optical thickness (COT) from VIIRS is good parameter for ATMS cloud screening.

The results indicate that the use of VIIRS high spatial resolution cloud products can improve the accuracy of hurricane forecasts by correctly eliminating cloud contaminated ATMS pixels. Figure 76 shows the track and SLP RMSEs of Typhoon Neoguri (2014) forecasts from assimilation of ATMS radiances with VIIRS cloud detection (COT<5) (green line), ATMS and CrIS radiances with VIIRS cloud detection (blue line), and ATMS and CrIS radiances with GSI cloud detection (red line). The cloud fraction (CF) within CrIS sub-pixel from VIIRS cloud mask can help CrIS radiance assimilation while the COT within ATMS sub-pixel from VIIRS can improve ATMS radiance assimilation.



## ATMS & CrIS assimilation experiments with imager cloud products

### Collocation btw MW/IR and imager cloud products:

- ATMS/VIIRS COT onboard NPP
- CrIS/VIIRS cloud mask onboard NPP

### WRF-ARW v3.6:

- 12 km horizontal resolution
- 51 vertical layers from surface to 10 hPa

### GSI v3.3:

- 3-Dvar Data Assimilation Method
- GFS background error covariance matrix
- Cycled bias correction
- Conventional Data: GTS
- Satellite radiances: ATMS, CrIS

### Typhoon Neoguri

- Assimilation : July 4 06z to July 7 00z, 2014
- Forecasts: July 4 06z to July 10 00z, 2014
- Assimilation every 6 hour
- Assimilation window: 150 min

Note that ATMS and CrIS radiances with VIIRS cloud detection provide best track forecasts in this case (blue line). GTS is the conventional dataset in the experiments.

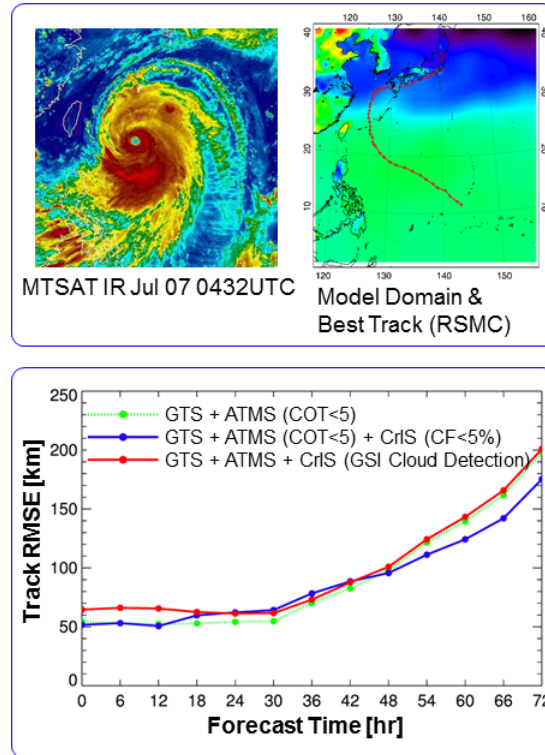

Figure 76. The track RMSEs of Typhoon Neoguri (2014) forecasts from assimilation of ATMS radiances with VIIRS cloud detection (COT<5) (green line), ATMS and CrIS radiances with VIIRS cloud detection (blue line), and ATMS and CrIS radiances with GSI cloud detection (red line), respectively.

### Publications and Conference Reports

Han, Hyojin, Jun Li, Mitch Goldberg, Pei Wang, Jinlong Li, Zhenglong Li, B.-J. Sohn, and Juan Li, 2015: Microwave sounder cloud detection using a collocated high resolution imager and its impact on radiance assimilation in tropical cyclone forecasts, *Journal of Geophysical Research – Atmosphere* (under revision).

Han, Hyojin, Jun Li et al. 2015: Han Improving tropical cyclone forecasts by assimilating microwave sounder cloud-screened radiances and the GPM precipitation measurements, ITSC20, 28 October – 03 November 2015, Lake Geneva, Wisconsin, U.S.A.

## 28. Implementation of GCOM-W1 AMSR2 Snow Products

**CIMSS Task Leader: Yong-Keun Lee**

**NOAA and other collaborators: Jeffrey R. Key and Cezar Kongoli (CICS)**

**Budget: \$50K**

### NOAA Long Term Goals:

- Climate Adaptation and Mitigation
- Weather-Ready Nation



### **NOAA Strategic Goals:**

- Serve society's needs for weather and water
- Understand climate variability and change to enhance society's ability to plan and respond
- Support the nation's commerce with information for safe, efficient and environmentally sound transportation
- Provide critical support for the NOAA mission

### **CIMSS Research Themes:**

- Satellite Meteorology Research and Applications
- Satellite Sensors and Techniques
- Environmental Models and Data Assimilation
- Education and Outreach

### **Objective**

The objectives of this project include continuous testing and validation of the selected snow algorithm and routine snow product generation with AMSR2 data. The selected heritage algorithms are being modified as necessary.

### **Project Overview**

Snow is one of the most dynamic hydrological variables on the Earth's surface and the cryospheric component with the largest seasonal variation in spatial extent. It also plays a key role in the global energy and water budget. Since microwave radiation is unhindered by darkness and clouds and penetrates a deeper layer of snow cover at certain frequencies, satellite passive microwave measurements have been used to detect snow cover and snow depth globally in nearly all weather conditions. The Advanced Microwave Scanning Radiometer 2 (AMSR2) instrument launched on the Japan Aerospace Exploration Agency (JAXA) Global Change Observation Mission 1st – Water "SHIZUKU" (GCOM-W1) satellite. NOAA is supporting work with AMSR2 as part of the Joint Polar Satellite System (JPSS) program.

Monitoring of cryosphere, and in particular of the Earth's snow cover, is among primary applications of the AMSR2 instrument. AMSR2 cryosphere environmental data records (EDRs) are Ice Characterization, Snow Cover/Depth, and Snow Water Equivalent (SWE). Ice Characterization includes ice "age" (ice free, first-year, and multiyear ice) and ice concentration. Snow Cover/Depth includes a binary snow/no snow mask and the depth of snow on land. Snow Water Equivalent is the liquid equivalent depth of the snow cover.

The objectives of this project include testing and validation of the selected snow algorithm and routine snow product generation with AMSR2 data. The selected heritage algorithms are being modified as necessary.

### **Milestones with Summary of Accomplishments and Findings**

The suite of AMSR2 algorithms developed for the retrieval of snow cover and snow depth is comprised of well-established methods. They are being modified, as necessary, to adapt them to AMSR2 and to improve their accuracy. The snow cover detection algorithm is based on a brightness temperature-based decision tree approach (Grody, 1991; Grody and Basist, 1996) with additional climatology tests as enhancements. The snow depth algorithm is based on a dynamic empirical approach (Kelly, 2009) blended with a routine for dry/wet snow differentiation.





Accomplishments for this project year include helping NOAA to set up the AMSR2 snow algorithm correctly which is being delivered for the operational use. Table 9 shows one day comparison of the retrieved AMSR2 snow cover, snow depth, and SWE comparison between NOAA GCOM-W1 AMSR2 Algorithm Software Processor (GAASP) and CIMSS.

During the next project year we will further refine the snow detection, snow depth methodologies and snow water equivalent algorithm.

**Table 9. One day comparison of GAASP outputs with corrected and uncorrected BT and CIMSS output with uncorrected BT for Jan. 15, 2015.**

	GAASP : correct BT	GAASP : uncorrected BT	CIMSS : uncorrected BT
Snow Cover			
Overall accuracy	81.17 %	79.84 %	79.75 %
Snow detection rate	78.34 %	76.40 %	76.35 %
Commission error	1.78 %	1.59 %	1.57 %
Omission error	17.05 %	18.57 %	18.68 %
Number of pixels	1504245	1504245	1524368
Snow Depth			
Bias	-0.50 cm	-0.46 cm	-0.48 cm
RMSE	18.7 cm	19.40 cm	19.23 cm
Number of pixels	2432	2144	2162
Snow Water Equivalent			
Bias	-0.22 mm	-0.16 mm	-0.17 mm
RMSE	31.35 mm	31.61 mm	31.62 mm
Number of pixels	26639	22279	21609
Mean (AMSR2)	62.06 mm	61.68 mm	61.68 mm

### Publications and Conference Reports

Lee, Y.-K., C. Kongoli, and J. R. Key, 2015, "An in-depth evaluation of heritage algorithms for snow cover and snow depth using AMSR-E and AMSR2 measurements", *J. Atmos. Oceanic Technol.*, 32, 2319-2336. doi: 10.1175/JTECH-D-15-0100.1.

### References

Brown, R. D. and P. W. Mote, (2009), The Response of Northern Hemisphere Snow Cover to a Changing Climate. *J. of Climate* 22, 2124–2145.

Grody, N. C., (1991), Classification of snow cover and precipitation using the special sensor microwave imager, *J. Geophys. Res.*, 96 (D4), pp 7423-7435.



Grody, N. C., and A. N. Basist, (1996), Global identification of snowcover using SSM/I measurements, *IEEE Trans. Geosci. Remote Sens.*, 34 (1), pp 237-249.

Kelly, R., (2009), The AMSR-E snow depth algorithm: description and initial results, *J. Remote Sensing Soc. Japan*, 29 (1), pp 307-317.

Sturm, M, J. Holmgren, and G. E. Liston, (1995), A seasonal snow cover classification system for local to global applications, *J. of Climate*, 8, 1261-1283.

## **29. CIMSS Participation in VIIRS Cloud Products Using DNB the JPSS Risk Reduction Program for 2014**

**CIMSS Task Leader: Andi Walther**

**NOAA Collaborator: Andrew Heidinger**

**Budget: \$32K**

### **NOAA Long Term Goals:**

- Climate Adaptation and Mitigation
- Weather-Ready Nation

### **NOAA Strategic Goals:**

- Serve society's needs for weather and water
- Understand climate variability and change to enhance society's ability to plan and respond
- Provide critical support for the NOAA mission

### **CIMSS Research Themes:**

- Satellite Meteorology Research and Applications
- Satellite Sensors and Techniques

### **Objective**

This project aims to extend the developments of VIIRS Nighttime Lunar reflectance-derived cloud products to meteorological applications.

### **Project Overview**

The primary goal of this project is to continue advancing the use of the DNB lunar reflectance and the associated quantitative cloud property retrievals. Capitalizing on this unique and unprecedented capability, we use these cloud properties to develop proof-of-concept nocturnal precipitation and icing threat applications. This new source of nighttime information holds important value to NWP applications in high-latitude regions challenged by extensive nighttime periods, such as Alaska. These cloud properties can be incorporated into the official NOAA precipitation and icing applications in the future.

In support of this effort, we will conduct research in the following core elements:

- Further improvements and refinements to a lunar reflectance based nighttime cloud optical retrieval scheme;
- Use lunar reflectance for improved cloud cover and cloud type retrievals at night;
- Show the consistency of these products to the daytime equivalent;

- Explore application of the retrieved nocturnal cloud products to precipitation and ice threat products, yielding new capabilities for these operationally important products; and
- Introduce the retrievals to operational and quasi-operational environment CSPP, NOAA framework and CLAVR-x.

### Milestones with Summary of Accomplishments and Findings

Efforts in this period focused on drafting first versions of precipitation rate retrieval from existing cloud products from NLCOMP. The product “rain rate” is now output of level-2 CLAVR-x output. Figure 77 shows comparison of NLCOMP derived rain rate to MIRS ATMS rain rate.

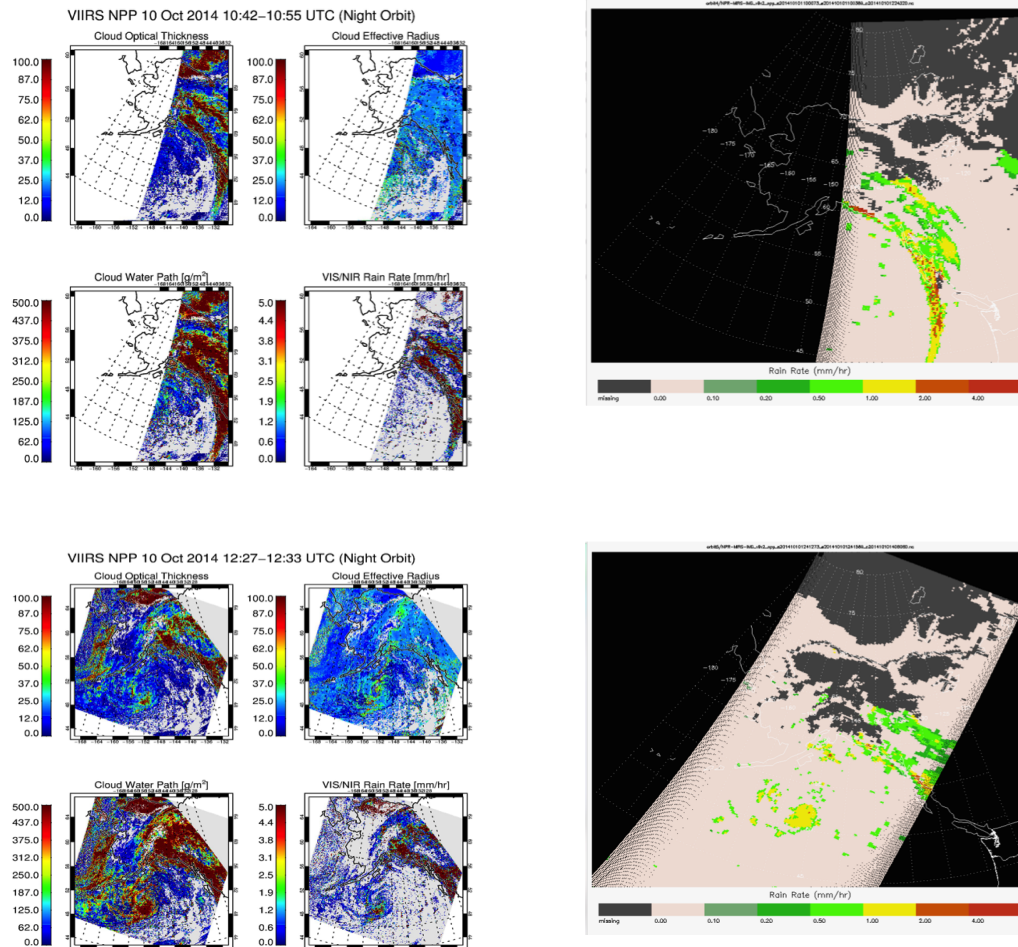

Figure 77. NLCOMP cloud products and provisional rain rate retrieval from VIIRS Day/Night Band Lunar reflectance (left) and MIRS ATMS microwave based passive (right) for 10th October 2014 for two night orbits.

### Publications and Conference Reports

- Andi Walther presented NLCOMP algorithm at the CSPP meeting in Darmstadt/ Germany in April 2015.
- Andi Walther presented NLCOMP algorithm at EUMETSAT conference in Toulouse, at ITOVS conference in Lake Geneva, WI and at AGU Fall meeting in San Francisco Dec 2015.



- Andi Walther presented new applications at TOVS conference at Lake Geneva, Wisconsin in October 2015.

### **30. Support CIMSS JPSS and AWIPS II OCONUS Satellite Liaison**

**CIMSS Task Leader: Jordan Gerth**

**NOAA Collaborator: Bill Ward and Eric Lau, National Weather Service Pacific Region Headquarters, and Carven Scott, National Weather Service Alaska Region Headquarters**

**Budget: \$160,000**

#### **NOAA Long Term Goals:**

- Weather-Ready Nation

#### **NOAA Strategic Goals:**

- Serve society's needs for weather and water
- Provide critical support for the NOAA mission

#### **CIMSS Research Themes:**

- Satellite Meteorology Research and Applications
- Satellite Sensors and Techniques
- Environmental Models and Data Assimilation
- Education and Outreach

#### **Objective**

This project entails a designated scientist focusing on improving NOAA's research to operations (R2O) mechanisms and maximizing the operational value of geostationary and polar-orbiting satellite data and research products, particularly through activities centered on National Weather Service (NWS) weather forecast offices to improve services in states and territories beyond the contiguous United States, such as Hawaii, Guam, American Samoa, Micronesia, and Alaska.

#### **Project Overview**

The Outside CONTiguous United States (OCONUS) satellite scientist serves three primary functions beyond his capacity as a satellite meteorologist and remote sensing scientist for NWS forecast offices in the states of Alaska and Hawaii, and the territories of Guam, American Samoa, and Puerto Rico. First, the scientist is a software developer and technical consultant, focusing on Advanced Weather Interactive Processing System (AWIPS) and the NWS technical infrastructure, including networking, data flow, and antenna systems, to assure satellite imagery and products are making it to the field and meeting the needs of operational meteorologists throughout the United States. Second, the scientist is a coordinator of regional satellite proving ground and related activities, including the visiting scientist program in NWS Pacific Region, which introduces new capabilities of OCONUS value to the relevant field offices. Third, the scientist is a liaison for meteorologists and office management in NWS Pacific Region and NWS Alaska Region to assist in the development and delivery of training and addressing specific questions about the capabilities of current and future meteorological satellites, particularly the Geostationary Operational Environmental Satellite R-Series (GOES-R) and Joint Polar Satellite System (JPSS).

#### **Milestones with Summary of Accomplishments and Findings**

The scientist funded under this project:



- conducts scientific investigations and serving as the coordinator for demonstrating JPSS science products in NWS Pacific Region and NWS Alaska Region operations;
- integrates GOES-R, Himawari, and JPSS imagery and science products into the AWIPS II; and
- acts as a technical coordinator and AWIPS II developer for GOES-R and JPSS proving ground partners.

The major milestones and related accomplishments between 1 July 2015 and 31 March 2016 are indicative of the value of this project. Specifically, the scientist:

- worked with the Community Satellite Processing Package (CSPP) package development team to establish output formats that are compatible with AWIPS, and conducted related testing;
- configured AWIPS at NWS Pacific Region to display Himawari imagery at the highest spatial, spectral, and temporal resolution available, with Eric Lau;
- served as part of the Satellite Enhancement Team (SET) to ensure that “day one” visualization of imagery from GOES-R, and related training containing imagery examples, is satisfactory;
- participated in the Satellite Training Advisory Team (STAT) to recommend foundational course content for all NWS meteorologists related to GOES-R;
- participated in the Experimental Products Development Team (EPDT) to finish development of the active fires plug-in for AWIPS II;
- conducted independent research related to visualizing multi-spectral composite imagery;
- began planning for the June 2016 OCONUS meeting in Honolulu, Hawaii;
- maintained the L/X-band antenna at Honolulu Community College and assured that imagery and products from the antenna system were available to the NWS Pacific Region and Honolulu forecast office; and
- supported the JPSS river ice and flooding initiative, with Dave Santek, increasing the use of Visible Infrared Imaging Radiometer Suite (VIIRS) imagery and products in certain the NWS River Forecast Centers (RFCs).

The scientist attended the following meetings during the award period:

- JPSS Science Team Meeting (College Park, Maryland);
- National Weather Association Annual Meeting (Oklahoma City, Oklahoma);
- Asia/Oceania Meteorological Satellite Users’ Conference (Tokyo, Japan); and
- American Meteorological Society Annual Meeting (New Orleans, Louisiana).

### **Publications and Conference Reports**

GOES-R: The New Generation Begins with Himawari-8

Talk, National Weather Association Annual Meeting—Plenary Session II (Oklahoma City, Oklahoma)

October 19, 2015

The Himawari training program for NWS Pacific Region meteorologists

Talk, Asia/Oceania Meteorological Satellite Users’ Conference—Capacity development and training activities (Tokyo, Japan)

November 12, 2015

Developing AWIPS to support forecaster demands in the new generation of satellites

Talk, American Meteorological Society Annual Meeting—32nd Conference on Environmental



Information Processing Technologies (New Orleans, Louisiana)  
January 11, 2016

Increased Satellite Reception and Utilization Capabilities in NWS Pacific Region  
Talk, American Meteorological Society Annual Meeting—12th Symposium on New Generation  
Operational Environmental Satellite Systems (New Orleans, Louisiana)  
January 12, 2016

### **31. JPSS Ground Project Field Terminal Node Support 2015**

**CIMSS Task Leader: Liam Gumley**

**CIMSS Support Scientists: Scott Mindock, Ray Garcia, Graeme Martin, Kathy  
Strabala, Jess Braun**

**NOAA Collaborator: Mitch Goldberg**

**Budget: \$449K**

#### **NOAA Long Term Goals**

- Weather-Ready Nation

#### **NOAA Strategic Goals**

- Serve society's needs for weather and water
- Provide critical support for the NOAA mission

#### **CIMSS Research Themes**

- Satellite Meteorology Research and Applications
- Satellite Sensors and Techniques

#### **Objective**

Provide the following deliverables and services to the DB community:

- JPSS SDR software for Suomi NPP in a package ready to use for real time applications,
- All necessary lookup tables and ancillary data needed to run the SDR software,
- Quality control for the DB SDR products to ensure they are in agreement with the SDR products from IDPS, and
- Support desk service for the DB user community for the SDR software.

#### **Project Overview**

CIMSS/SSEC supports JPSS FTS by providing algorithm and software integration services to enable users to integrate the algorithms into their remote terminals through the development of user-friendly software packages. The support from the JPSS Program for the development and maintenance of these software packages will demonstrate the ability to create ready-to-use products from the HRD link and provide risk reduction effort at a minimal cost. CIMSS/SSEC will provide software packages, supporting ancillary data, documentation and training, end user support, and value added products and software as part of this effort. CIMSS/SSEC will acquire and process HRD from SNPP and JPSS using its existing 2.4-meter X/L-band antenna system to track the quality of the HRD transmission and monitor the validity of the products created from the HRD broadcast.

#### **Milestones with Summary of Accomplishments and Findings**

The CSPP SDR software package is based on the Algorithm Development Library (ADL) software developed by Raytheon for the JPSS Project. ADL allows the operational processing



algorithms for Suomi NPP to run without modification in a Linux environment. SSEC has packaged the ADL versions of the Suomi NPP algorithms so they can run from the Linux command line in real-time direct broadcast mode, but we have not changed the underlying processing software, algorithms, or data formats. The output files from the CSPP SDR processing software are identical in naming, format, and structure to the corresponding files from NOAA/NESDIS. The native format for SNPP SDR products is IDPS HDF5.

On 1 April 2016, a new CSPP SDR package was released supporting the calibration and geolocation of the Visible Infrared Imaging Radiometer Suite (VIIRS), Advanced Technology Microwave Sounder (ATMS), and the Cross-track Infrared Sounder (CrIS) instruments onboard the JPSS S-NPP satellite.

New features in CSPP SDR Version 2.2 include:

- Updated code base to ADL 4.2.11 (Mx8.11);
- Updated ancillary data scripts;
- Added new VIIRS ancillary data set dependence - a daily reflective solar calibration coefficients file;
- VIIRS M-Band 6 SDR radiance to reflectance changes;
- Quick look display and execution performance improvements including CrIS image interpolation through deleted direct broadcast FOVs; and
- CSPP SDR Version 2.2 can be used for creating VIIRS, CrIS and ATMS SDRs from historical data sets beginning on 5 July 2014 to the present.

The CSPP team performed exhaustive quality control checks on the VIIRS, CrIS, and ATMS SDR products from the CSPP SDR package, to verify that they were in agreement with the same products from IDPS.

CIMSS/SSEC produced VIIRS imagery throughout the reporting period and provided it in real time to the National Weather Service for display in AWIPS.

CIMSS/SSEC continued to maintain and enhance the website for the CSPP software packages. CSPP registration statistics and download statistics via the website were collected throughout the reporting period. As of April 2016, there were more than 1100 registered users of CSPP, and more than 7000 individual downloads had been tracked via the website.

CIMSS/SSEC continued to ingest all required ancillary data for the VIIRS, CrIS, and ATMS SDRs and to make them available for download to users of the CSPP SDR software. End users are able to run an automated script that will check for new LUTs on the CIMSS/SSEC FTP site, and if necessary download, unpack, and install the LUTs without user intervention. CIMSS/SSEC obtained the LUTs from the JPSS Common CM and from the NASA Land PEATE for this purpose.

CIMSS/SSEC provided prompt support to CSPP users throughout the reporting period, successfully resolving various installation and operational issues at DB sites around the world including NRL Monterey, NRL Stennis, EUMETSAT, FMI, and University of Alaska.

### **Publications and Conference Reports**

“CSPP Polar Orbiting Satellite Software and Products” was presented at the CSPP/IMAPP Users Group meeting at EUMETSAT in Darmstadt Germany by Liam Gumley in April 2015.



“Community Satellite Processing Package (CSPP): Support for multiple satellites and sensors for real-time decisions” was presented at the American Meteorological Society Annual Meeting in New Orleans by Liam Gumley in January 2016.

## **32. CIMSS Participation in Upgrade and Extension of NOAA’s OSSE Capabilities**

**CIMSS Task Leaders: Jun Li, Zhenglong Li**

**CIMSS Support Scientists: Feng Zhu, Agnes Lim, Kevin Baggett**

**NOAA Collaborators: Tim Schmit, NOAA/NESDIS/STAR, Robert Atlas, NOAA/AOML**

**Budget: \$200,000**

### **NOAA Long Term Goals:**

- Weather-Ready Nation

### **NOAA Strategic Goals:**

- Serve society’s needs for weather and water
- Support the nation’s commerce with information for safe, efficient and environmentally sound transportation
- Provide critical support for the NOAA mission

### **CIMSS Research Themes:**

- Satellite Meteorology Research and Applications
- Satellite Sensors and Techniques
- Environmental Models and Data Assimilation

### **Objective**

The objective is to use quick r-OSSE to explore the value added impact from future advanced IR sounder on hurricane forecast.

### **Project Overview**

The main focus of this project is for CIMSS to participate the upgrade and extension of NOAA OSSE capabilities. The CIMSS scientists will focus on two tasks: 1) enhancing the quick r-OSSE framework to include more capabilities, and 2) using quick r-OSSE to explore the better assimilation of future advanced sounder observations. The ultimate goal is to develop a comprehensive quick r-OSSE framework that can be used for quick assessment of instrument’s impact. Under this proposal, CIMSS will continue providing expertise and support of simulated satellite observations to AOML, JCSDA and NSSL for their OSSE work.

### **Milestones with Summary of Accomplishments and Findings**

#### ***Orbit Simulator for Common Satellite Instruments (July – November 2015)***

An orbit simulator was developed for 16 common satellite sounder instruments, including IASI, CrIS, AIRS, AMSU-A, ATMS, the High Resolution Infrared Radiation Sounder (HIRS) and the Microwave Humidity Sounder (MHS). It is capable of accurately predicting needed orbital information for synthetic observation simulations, including geolocation, satellite geometry, solar geometry, time and etc (Nagle and Holz 2009). Validation shows an excellent agreement with real observations. Based on this orbit simulator, a radiance simulator was developed to simulate synthetic satellite radiances with the Goddard Earth Observing System Model, Version 5 (GEOS-





5) Nature Run (G5NR, Gelaro et al 2014). The Community Radiative Transfer Model (CRTM, Weng and Liu 2003) with ODAS coefficients is used for forward simulation. The noise was added based on instrument specification of Noise Equivalent Delta Radiance (NeDR). Other components included in the radiance simulator are a Binary Universal Form for the Representation of meteorological data (BUFR) encoder, an IR hyperspectral sounding retrieval software, and a PrepBUFR encoder.

### ***GEO VS LEO on Hurricane Forecast (October 2015 – February 2016)***

Migliorini (2012) showed that there exists equivalence between radiance and retrieval assimilation. However, the retrieval assimilation might be advantageous for advanced IR sounders because of the usage of more channels than radiance assimilation. Previous experiments have shown that retrieval assimilation has advantage for tropical cyclone forecasts when all channels are used in retrieval process (Li et al. 2015). Sounding retrievals from GEO AIRS (representing the future GEO hyperspectral IR sounders) are assimilated into Gridpoint Statistical Interpolation (GSI) along with conventional data (the Radiosonde observations (RAOB)). The hurricane forecast from the Weather Research and Forecasting (WRF) - ARW is compared with that from assimilating LEO AIRS sounding plus conventional data. The results (Figure 78) show that the GEO AIRS is able to provide additional benefit to the hurricane track forecast. Over a 48-hour forecast, the averaged track error is significantly reduced from 91.7 to 73.4 km. Figure 78 shows results based on 6-hour cycling; none cycling and 3-hour cycling show similar results. These results indicate that the increased spatial coverage from GEO provides positive impact on hurricane track forecast.

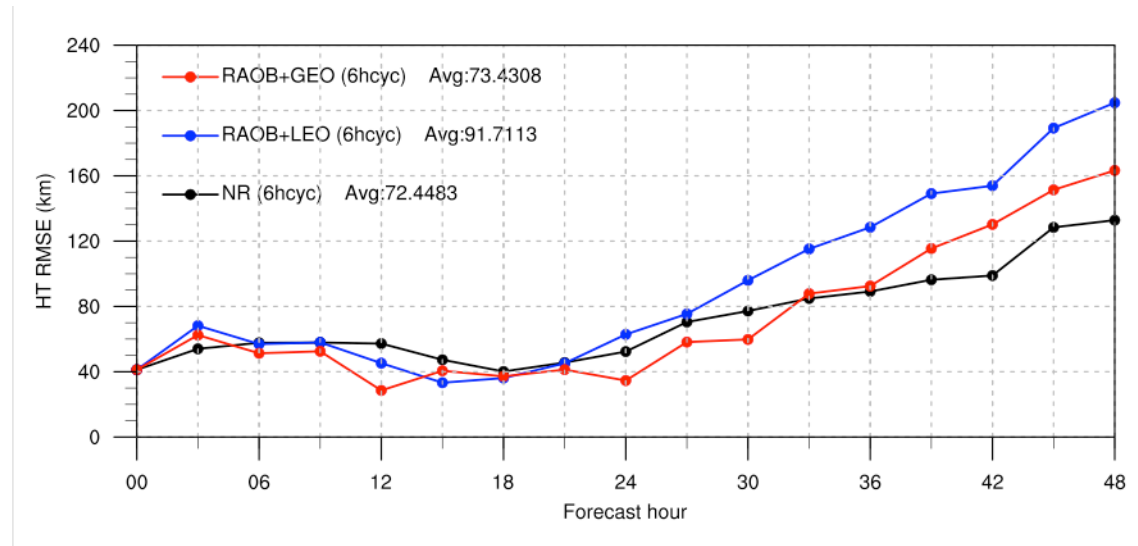

**Figure 78. Impact of GEO AIRS on Hurricane Sandy track forecast versus that of LEO AIRS. Notice the overall improvement by GEO AIRS over the whole forecast period. The black line is the forecast ceiling of the track error from assimilating the NR. Note how the GEO AIRS is approaching the forecast ceiling (72.45 km).**

### ***Exploring GEO High Temporal Resolution (December 2015 – March 2016)***

The GEO AIRS soundings are assimilated at different cycles, such as hourly, 3-hourly, 6-hourly and none cycles. The results from Figure 79 show that hourly cycling yields best hurricane track forecast; the averaged track error is 66.4 km, smaller than all other three experiments (69.6 km for 3h cycling, 73.4 km for 6h cycling, and 95.6 km for none cycling). These results indicate that high temporal resolution from GEO is able to provide positive impact on the hurricane track forecast.

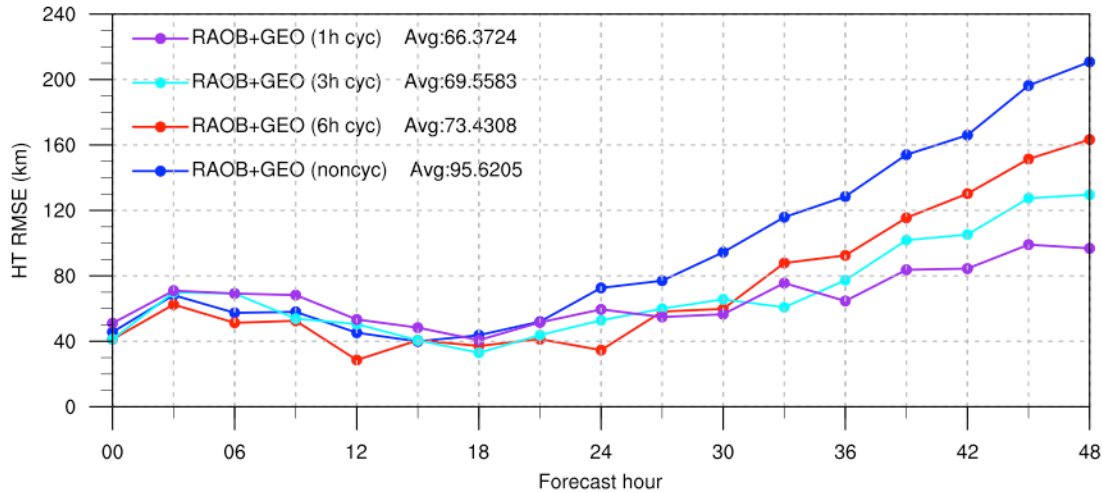

Figure 79. Impact of high temporal resolution from GEO AIRS on Hurricane Sandy track forecast. Notice that more frequent assimilation leads to better track forecast: 1hcyc > 3hcyc > 6hcyc > noncyc.

### Forecast Ceiling (November 2015 – January 2016)

It is important to understand how good the forecast is, meaning how much room left for further improvement. For each GEO experiment, there exists a forecast ceiling, which is the best forecast one may get by assimilating the NR. No experiments are expected to exceed the forecast ceiling because no observations have higher accuracy than the NR. In Figure 78, the forecast ceiling at 6h cycling is also shown. While slightly worse, the results from the GEO AIRS is very close to the forecast ceiling, indicating the GEO is capable of providing most of the sounding information for NWP models.

### Forecast Ceiling (February 2016 - now)

A new relocation technique is under development to adjust the initial position of the hurricane center. Due to the lack of observations of hurricane center position, the assimilation is not able to fix the initial position error. The relocation technique is expected to reduce that error and improve the track forecast.

### Publications and Conference Reports

Li, Zhenglong; Li, J.; Schmit, T. J.; Zhu, F.; Wang, P.; Lim, A.; Li, J.; Atlas, R. and Hoffman, R. N. A quick regional OSSE impact study on geostationary hyperspectral infrared sounder for hurricane forecasts. Conference on Integrated Observing and Assimilation Systems for the Atmosphere, Oceans, and Land Surface (IOAS-AOLS), 20th, New Orleans, LA, 10-14 January 2016.

Li, Jun; Schmit, Timothy J.; Li, Zhenglong; Zhu, Feng; Lim, Agnes; Atlas, Robert and John, Pereira. Value-added impact from future geostationary hyperspectral infrared sounder observations on hurricane forecasts. AGU Fall Meeting, San Francisco, CA, 14-18 December 2015. American Geophysical Union, Washington, DC, 2015.

Li, Zhenglong; Li, J.; Schmit, T. J.; Zhu, F.; Wang, P.; Lim, A.; Li, J.; Atlas, R. and Hoffman, R. N. Exploring Value-added Impact from Geostationary Hyperspectral Infrared Sounder on Hurricane Forecasts. International TOVS Study Conference, 20th, Lake Geneva, Wisconsin, 28 October - 3 November 2015.



## References

Gelaro, R.; Putman, W.M.; Pawson, S.; Draper, C.; Molod, A.; Norris, P.M.; Ott, L.; Prive, N.; Reale, O.; Achuthavariar, D.; et al. Evaluation of the 7-km GEOS-5 Nature Run; Technical Report Series on Global Modeling and Data Assimilation 36; NASA Global Modeling and Assimilation Office: Greenbelt, MD, USA, 2014.

Migliorini, S., (2012): On the equivalence between radiance and retrieval assimilation, *Mon. Wea. Rev.*, 140, 258-265.

Nagle, F. W., and R. E. Holz (2009), Computationally efficient methods of collocating satellite, aircraft, and ground observations, *J. Atmos. Oceanic Technol.*, 26, 1585–1595, *doi:10.1175/2008JTECHA1189.1*.

Weng, F., and Q. Liu, 2003: Satellite Data Assimilation in Numerical Weather Prediction Models. Part I: Forward Radiative Transfer and Jacobin Modeling in Cloudy Atmospheres. *J. Atmos. Sci.*, 60, 2633–2646.

## 33. Radiance and Retrieval Simulation for NSSL Regional OSSE

**CIMSS Task Leader: Jun Li, Zhenglong Li**

**NOAA Collaborators: Tim Schmit (NOAA/NESDIS/STAR), Steven Koch (NOAA/OAR/NSSL), Thomas Jones (NOAA/OAR/NSSL)**

**Budget: \$15,000**

### NOAA Long Term Goals:

- Weather-Ready Nation

### NOAA Strategic Goals:

- Serve society's needs for weather and water
- Support the nation's commerce with information for safe, efficient and environmentally sound transportation
- Provide critical support for the NOAA mission

### CIMSS Research Themes:

- Satellite Meteorology Research and Applications
- Satellite Sensors and Techniques
- Environmental Models and Data Assimilation

## Objective

The objective is to simulate satellite radiances for NSSL/CIMMS on regional OSSE studies.

## Project Overview

This project is for the University of Wisconsin-Madison (UW-Madison) Cooperative Institute for Meteorological Satellite Studies (CIMSS) to support the Cooperative Institute for Mesoscale Meteorological Studies (NSSL/CIMMS) of University of Oklahoma (OU) on regional Observing System Simulation Experiments (R-OSSEs). CIMSS role includes simulating the advanced infrared (IR) sounder radiances along with sounding retrievals through inverse process from a high resolution nature run, for a typical case selected by CIMMS/OU.



## Milestones with Summary of Accomplishments and Findings

### ***Generating Synthetic GEO AIRS Radiance Observations and Sounding Retrievals (July 2015 - now)***

NSSL found a potential serious issue with the nature run from previous year. They decided to reprocess it. The new NR uses WRF-ARM instead of NMM. After changing the simulation code to adjust to ARW, the GEO AIRS radiances were generated using the clear sky Stand-alone AIRS Radiative Transfer Algorithm (SARTA, Strow et al. 2003) for clear sky only, and SARTA coupled with the single layer cloudy model by Wei et al. (2004) for cloudy region. A quick regression scheme was developed to retrieve temperature and moisture profiles from the simulated radiances in clear skies (Li et al., 2008; 2009) and part of cloudy regions. 5% of all available data were used as training to generate the regression coefficients, which were then applied to all data to generate atmospheric sounding retrievals. The retrievals were quality controlled to remove bad retrievals by comparing the calculated radiances from the regression retrieval with the synthetic radiances. Figure 80 shows the retrieval standard deviation error of temperature and moisture profiles as compared with NR. Based on the retrieval results and evaluation, CIMSS has advised NSSL to assimilate sounding profiles away from surface and stratosphere, such as between 150 hPa and 8 levels above surface.

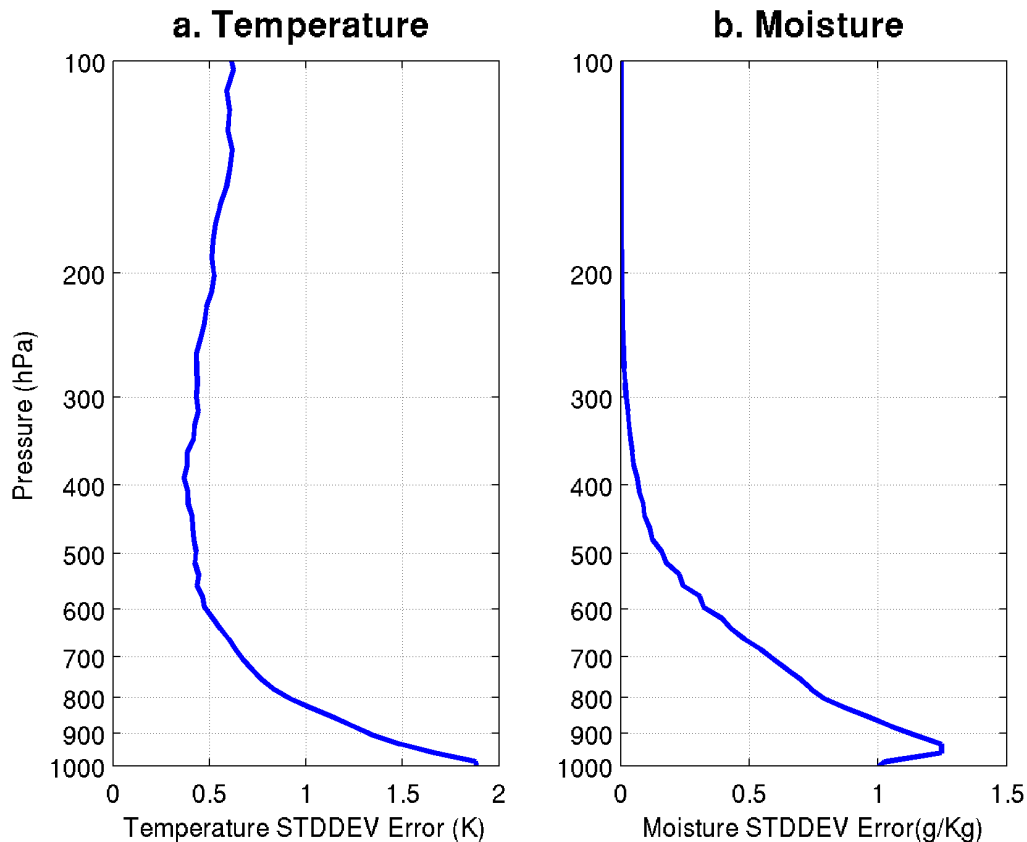

Figure 80. The standard deviation error of the synthetic sounding retrievals from the GEO AIRS of a) temperature and b) moisture.

### ***Collaborating Work on the OSSE Manuscript (October 2015 – December 2015)***

A manuscript (titled: Assimilating synthetic hyperspectral sounder temperature and humidity retrievals to improve severe weather forecasts) was written based on the findings of the OSSE experiments conducted by NSSL with Dr. Thomas Jones as the leading author. CIMSS provided



writing for the section of synthetic radiance simulation and generation of synthetic atmospheric sounding retrievals. The manuscript was submitted to Tellus and now under review.

### **Publications and Conference Reports**

Jones, Thomas; Koch S. ; Li, Z. Assimilating synthetic hyperspectral sounder temperature and humidity retrievals to improve severe weather forecasts. Submitted to Tellus. 2016

### **References**

Li, Z., J. Li, W. P. Menzel, J. P. Nelson III, T. J. Schmit, Elisabeth Weisz, and S. A. Ackerman, 2009: Forecasting and nowcasting improvement in cloudy regions with high temporal GOES Sounder infrared radiance measurements, *Journal of Geophysical Research. - Atmospheres*, 114, D09216, doi:10.1029/2008JD010596.

Li, Z., J. Li, W. P. Menzel, T. J. Schmit, J. P. Nelson, III, J. Daniels, and S. A. Ackerman, 2008: GOES sounding improvement and applications to severe storm nowcasting, *Geophys. Res. Lett.*, 35, L03806, doi:10.1029/2007GL032797.

Strow, L. L., S. E. Hannon, S. De Souza-Machado, H. E. Motteler, and D. Tobin (2003), An overview of the AIRS radiative transfer model, *IEEE Trans. Geosci. Remote Sens.*, 41, 303–313.

Wei, H., P. Yang, J. Li, B. B. Baum, H.-L. Huang, S. Platnick, Y. Hu, and L. Strow (2004), Retrieval of semitransparent ice cloud optical thickness from Atmospheric Infrared Sounder (AIRS) measurements, *IEEE Trans. Geosci. Remote Sens.*, 42, 2254– 2267.

## **34. Support for NPP and JPSS Data Assimilation Improvements and Data Denial Experiments**

**CIMSS Task Leader: James Jung**

**NOAA Collaborator: John Derber, Dennis Keyser, Walter Wolf**

**Budget: \$149K**

### **NOAA Long Term Goals:**

- Weather-Ready Nation

### **NOAA Strategic Goals:**

- Serve society's needs for weather and water
- Support the nation's commerce with information for safe, efficient and environmentally sound transportation
- Provide critical support for the NOAA mission

### **CIMSS Research Themes:**

- Satellite Meteorology Research and Applications
- Satellite Sensors and Techniques
- Environmental Models and Data Assimilation

### **Objective**

Improve the use of CrIS on SNPP and prepare for CrIS on JPSS1 in the NOAA/NCEP Global Forecast System.



## **Project Overview**

This project proposed to switch the National Centers for Environmental Prediction (NCEP) Global Data Assimilation System / Global Forecast System (GDAS/GFS) from assimilating a subset of the current 1305 Joint Polar Satellite System/National Polar-orbiting Partnership (JPSS/NPP) Cross-track Infrared Sounder (CrIS) channels to assimilating the 2211 channel (higher spectral resolution) CrIS dataset. We also proposed to improve the use of the longwave channels and exploit the information from the higher spectral resolution midwave and shortwave channels from the higher spectral resolution CrIS. Improvements in obtaining information from this instrument will improve the weather model initialization and potentially the forecasts.

The first activity will be to transition from the current CrIS configuration to using the higher spectral resolution CrIS and moving these changes into NCEP and National Environmental Satellite, Data and Information Service (NESDIS) operations. This transition work will involve coordination and logistics between NESDIS/STAR, NESDIS/OSPO, NCEP/EMC and NCEP/NCO. While helping with the transition, we will be reviewing the current CrIS channel selection and testing new channel combinations in the longwave region this first year. We will be reviewing the channels in the midwave and shortwave regions and making recommendations to NCEP on useful water vapor and other channels as follow on work.

## **Milestones with Summary of Accomplishments and Findings**

The changes to the GDAS software, to use the new CrIS full spectral resolution data, are currently being reviewed by NCEP. Various changes to help with performance and memory conservation have been incorporated due to recommendations from these reviews. These changes affect the performance and memory usage of the Atmospheric Infrared Sounder (AIRS) and the Infrared Atmospheric Sounding Interferometer (IASI) as well as CrIS. Modifications were also incorporated in preparation for the CrIS direct broadcast data. The GDAS software modifications are still in review and other fundamental changes may be requested. Once modifications are made to accommodate NCEP's operational requirements, the software will be reviewed by other agencies (ESRL, DTC, AFWA, and NASA.) to be considered for inclusion in the official Gridpoint Statistical Interpolation (GSI) code.

We are working with NCEP/EMC and NESDIS/STAR in reviewing the new CrIS Binary Universal Form for the Representation of meteorological data (BUFR) table. A flag was added to identify the BUFR with the CrIS full spectral resolution (FSR) data. Other edits were required to incorporate the extra 12 'guard' channels used to remove the channel apodization, if required. The cloud information from the Visible Infrared Imaging Radiometer Suite (VIIRS) has also been added in the BUFR file. Several content and timing tests were conducted with NESDIS/STAR and NCEP/EMC to improve data processing within NCEP. These improvements should allow NCEP to receive and process all 2211 CrIS full spectral resolution channels.

## **Publications and Conference Reports**

Jung, J. A., and M. D. Goldberg 2015: Infrared and Microwave Data Addition Observing System Experiment Impacts, *20<sup>th</sup> International TOVS Study Conference*, Madison WI, 28 Oct – 3 Nov 2015.

Jung, J. A., and M. Goldberg, 2015: Forecast Impact Studies from Data Addition Experiments Using the NCEP Global Forecast System. 13th JCSDA Technical Review Meeting & Science Workshop, College Park MD, 13-15 May 2015.



Jung, J. A., A. D. Collard, and M. D. Goldberg 2016: Infrared and Microwave Data Addition Observing System Experiment Impacts Using the NCEP Global Forecast System., Accepted *Wea. and Forecasting*.

### **35. CIMSS Cal/Val Activities in Support of the Calibration Work Group**

**CIMSS Task Leader: Mathew Gunshor**

**CIMSS Support Scientist: Jim Nelson**

**NOAA Collaborator: Tim Schmit**

**Budget: \$90,000**

#### **NOAA Long Term Goals:**

- Weather-Ready Nation

#### **NOAA Strategic Goals:**

- Serve society's needs for weather and water
- Provide critical support for the NOAA mission

#### **CIMSS Research Themes:**

- Satellite Meteorology Research and Applications
- Satellite Sensors and Techniques

#### **Objective**

Assist the GOES-R Calibration Working Group (CWG) on GOES-R pre-launch calibration/validation activities and preparing for post-launch calibration/validation activities.

#### **Project Overview**

CIMSS proposed to assist the GOES-R CWG in preparing for the GOES-R era. Experience with the current GOES-series on science checkouts and radiance quality assurance, as well as involvement on the GOES-R AWG developing a system for analyzing ABI product output, would be valuable to the CWG. CIMSS proposed to report to the CWG on issues affecting current GOES radiance quality. Knowledge gained from monitoring current GOES can be applied to GOES-R. CIMSS also proposed to continue to provide assistance to CWG analyzing JMA's AHI calibration and navigation.

#### **Milestones with Summary of Accomplishments and Findings**

Proposed activities for this project year were:

1. Assist CWG in preparation for ABI PLT:
  - a. Consult on the development of McIDAS for ABI applications and facilitate its utilities at CIMSS and STAR.
  - b. Analyze JMA's AHI data and report on
    - i. AHI performance and, by analogy, what can be expected for ABI.
    - ii. Based on AHI experience, what to watch out for during ABI PLT.
2. Assist CWG in analysis of calibration and navigation issues:
  - a. Support GOES-R ABI INR efforts.
  - b. Support GOES-R ABI calibration efforts.
  - c. Support analysis of the impacts of L1b issues on L2 products
3. Communicate with CWG:
  - a. Report via PSE Weekly when appropriate;
  - b. Regularly attend CWG meetings via phone/internet;



- c. Report on findings when appropriate, e.g., issues addressed by CIMSS that affect current GOES radiance quality.

CIMSS has had a representative at most Calibration Working Group (CWG) bi-weekly meetings (teleconferences). There have been various presentations from CIMSS periodically at these meetings. Topics have covered ABI, AHI, and current GOES, all with the focus on preparing for GOES-R. When appropriate, information was submitted to the CWG weekly status report to relay information about the team's activities.

A major anomaly with AHI data on Nov 12 was discovered and presented to CWG at the bi-weekly meeting. Imagery was severely affected and at least some bands would have been completely unusable for products. This turned out to be an issue with the AHI cryo-cooler, as reported by JMA later to CWG (Figure 81).

A subset of DOE-3 CMIP files were made available and were analyzed. There is a large offset of about 5% (or 0.05 reflectance factor) in the VIS/Near-IR bands. Starting with L1b radiances and using the coefficients stored in the files to convert to reflectance factor, CIMSS is unable to reproduce a close match of what is contained in corresponding CMIP files. There is a small offset in the brightness temperatures of the IR bands on the order of 0.01K. This is a scientifically small value but it is a large value computationally as we have discovered previously that machine precision is about  $10^{-6}$  when we use the same coefficients in the same equations calculating real numbers. We have seen and reported differences of this amount in previous tests and it is not clear if this is due to differences in how temperature is calculated from radiance, if the ground system rounds prematurely, or if it is something related to truncated values that can occur when storing real values as integers (using `scale_factor` and `add_offset`).

The CWG was provided a brief on how Data Quality Flags (DQFs) would be assigned for L1b ABI data and CIMSS reviewed this document. The DQF procedure was tied into aspects of the remapping process that were unknown to us previously. The remapping procedure as explained was non-optimal regarding saturated or under-saturated (negative) radiances and would negatively impact certain products, especially fire detection and characterization. This was reported to the CWG.

Other accomplishments reported to CWG, either via Weekly Report or meetings included:

- Reported to CWG on DOE-1/2 data set analysis (L1b converted to L2 inconsistencies discovered, metadata analysis);
- Checking AWG-generated proxy data that flows into AWIPS-II during the Ground Readiness Exercise (GRE). The proxy data are all 16 ABI channels simulated from WRF-CHEM; and
- Analyzed a subset of DOE-3 CMIP files and discovered discrepancies in reflectance factor calculations (approximately 5% or 0.05).



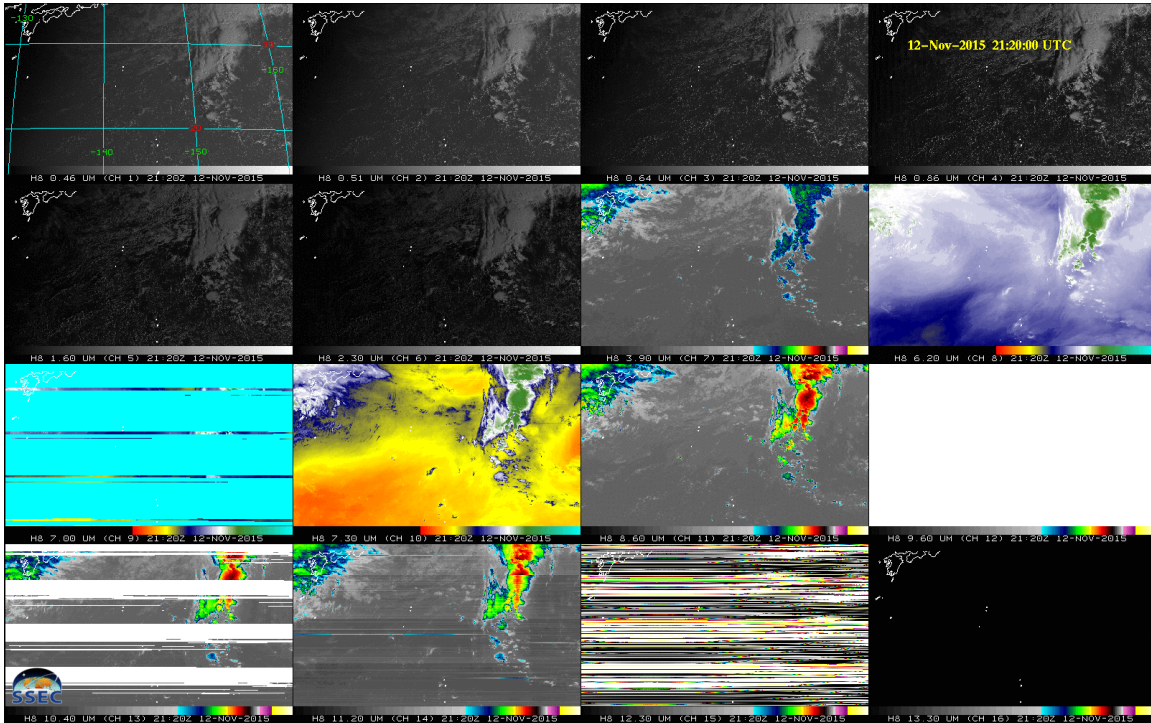

Figure 81. AVHRR 16 panel from November 12, 2015 at 21:20 UTC showing a major anomaly occurred to affect data. This turned out to be an issue with the cryo-cooler.

### 36. Support for Improving the Use of Air Borne Observations (ABO) in Daily Forecasting within NOAA NWS

CIMSS Task Leader: Timothy Wagner

CIMSS Support Scientists: Ralph Petersen, Jordan Gerth, Lee Cronce

NOAA Collaborators: Steve Pritchett, NOAA HQ; Rich Mamrosh, NOAA NWS WFO  
Green Bay

Budget: \$166,000

#### NOAA Long Term Goals:

- Weather-Ready Nation

#### NOAA Strategic Goals:

- Serve society's needs for weather and water
- Support the nation's commerce with information for safe, efficient and environmentally sound transportation
- Provide critical support for the NOAA mission

#### CIMSS Research Themes

- Satellite Sensors and Techniques
- Environmental Models and Data Assimilation

#### Objective

To increase the operational use of airborne observations in the National Weather Service (NWS) by creating new AWIPS display tools for aircraft-made soundings, by quantifying the impact of



ABO soundings on the Global Forecast Systems (GFS) numerical weather prediction model, and by validating the Water Vapor Sensing System II (WVSS-II) sensor in operational use.

### **Project Overview**

The WVSS-II is a small sensor mounted on the exterior of commercial aircraft that measures the water vapor mixing ratio throughout its flight and transmits it through the Aircraft Meteorological Data Relay (AMDAR). When coupled with the temperature, pressure, and wind observations typically recorded during flight, a complete thermodynamic and kinematic profile of the lower atmosphere is obtained every time an airplane takes off or lands. Data from these sensors can then be used by operational forecasters to monitor the evolution of the atmospheric state, and they can also be assimilated by forecast models in order to fill in the spatial and temporal gaps of the operational upper air observing network. WVSS-II has been shown to have good agreement with collocated radiosonde launches during field validation studies (Mamrosh et al. 2006).

This particular project has several tasks associated with it. The first is to develop a plugin for the Advanced Weather Interactive Processing System (AWIPS) computing environment used in NWS Weather Forecast Offices so that operational forecasters have one-click access to the latest profiles. While the data are currently available within AWIPS, it is a laborious process to display that data and few forecasters avail themselves of the opportunity to look at it. A related task, once the plugin has been rolled out, is to develop training materials for forecasters so that they can become familiar with the data, its strengths and limitations, and how it can inform their forecast process. It is anticipated that the training will be done through asynchronous webinars to allow for efficient training of a large number of forecasters now and into the future.

The remaining two tasks have more of a research and development focus as opposed to an immediate operational benefit. One is conducting a large-scale validation of the WVSS-II sensor through intercomparisons with collocated radiosonde launches. While the WVSS-II has undergone validation testing during short term single-location field experiments, no large scale validation has been accomplished. By comparing WVSS-II profiles with the operational radiosonde network, seasonal and geographic variations in sensor accuracy can be assessed. The final task is to use the Global Data Assimilation System (GDAS) to assimilate WVSS-II profiles into the GFS to assess the impact of this assimilation on the quantitative precipitation forecast (QPF) skill for warm season convective rain events. It is hypothesized that the additional information about low-level stability and moisture will increase QPF skill by improving the timing and intensity of rain events.

### **Milestones with Summary of Accomplishments and Findings**

The primary accomplishment thus far has been the development of a point-and-click interface for AWIPS that allows for the simple display of AMDAR profiles. This has been tested both on an in-house AWIPS workstation as well as a workstation at the NWS WFO Green Bay. A highly productive daylong workshop at the NWS WFO Green Bay brought together NWS and CIMSS personnel to discuss specifications for the plugin and to outline the format and direction of the training.

Simultaneously, a graduate student has been working on the infrastructure necessary to conduct the intercomparison study. Figure 82 shows a map of the locations of routine radiosonde launches (either NWS or outside agencies) as well as airports that hosted a WVSS-equipped airplane at some point in the first seven months of 2015. Of particular interest are the locations marked in blue, which are airports within 50 km of a radiosonde site and thus well-suited for intercomparisons. The previous validation efforts focused on short term field operations in either



Rockford, Illinois, or Louisville, Kentucky. This new intercomparison provides a much broader overview of all CONUS and will encompass seasonal variability.

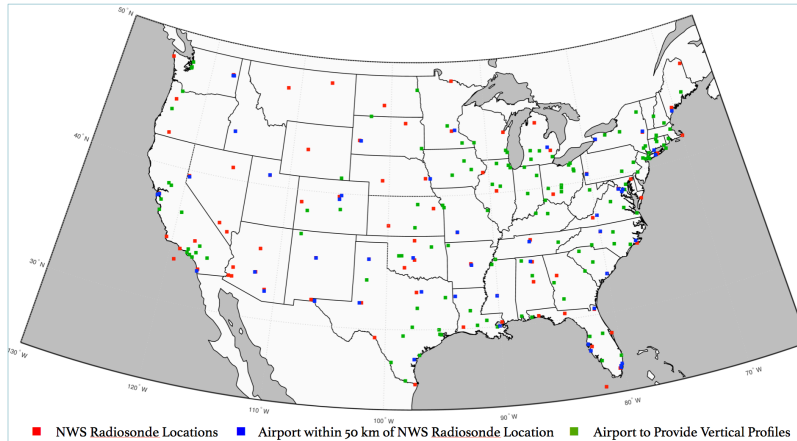

**Figure 82.** Locations of routine radiosonde launch sites (red), WVSS-visited airports within 50 km of a radiosonde (blue), and other WVSS-visited airports (green). The close proximity of radiosondes to aircraft profiles at the blue sites makes them ideal for intercomparing the two instruments.

However, there are two significant roadblocks to further success at the current stage of the project. The first is an AWIPS issue that has been known for five years: the system separately stores mixing ratio and dew point for aircraft soundings. In order to display a profile, it looks for the dew point and if it finds none, returns an empty profile instead. As a result, using the current AWIPS codebase, it is not possible to directly display WVSS-II profiles in AWIPS since the sensor measures water vapor mixing ratio directly. Our researchers are looking into a way to run a conversion within the plugin itself. Until this issue is resolved, however, the plugin cannot be distributed to other offices and the training materials cannot be developed.

The second significant issue is that after months of communication with NOAA’s high performance computing operations and several attempts at completing the proper documentation, our modeler has still not been able to gain access to the datasets and computers she needs to carry out the GFS. As a result, no progress has been made on the modeling portion of the project.

## References

Mamrosh, R., J. Gillis, R. Petersen, and R. Baker 2006: A comparison of WVSS-II and NWS radiosonde temperature and moisture data. *10<sup>th</sup> Symp. on Integrated Observing and Assimilation Systems for the Atmosphere, Oceans, and Land Surface (IOAS-AOLS)*. Atlanta, GA, Amer. Meteor. Soc. P3.9.

## 37. CIMSS End of Year Research Task Proposal

### 37.1 Real-time Monitoring of Lightning Detection Network Performance

**CIMSS Task Leader: John Cintineo**

**CIMSS Support Scientist: Justin Sieglaff**

**NOAA Collaborator: Michael Pavolonis**

**Budget: \$15,000**

#### NOAA Long Term Goals:

- Weather-Ready Nation



### **NOAA Strategic Goals:**

- Serve society's needs for weather and water
- Support the nation's commerce with information for safe, efficient and environmentally sound transportation
- Provide critical support for the NOAA mission

### **CIMSS Research Themes:**

- Satellite Meteorology Research and Applications
- Satellite Sensors and Techniques

### **Objective**

Total lightning flash data are being integrated and evaluated as part of the NOAA/CIMSS ProbSevere model, in an effort to expand its utility to OCONUS.

### **Project Overview**

Meaningful expansion of the ProbSevere model to regions outside CONUS (OCONUS) introduces several challenges, the most apparent being the lack of severe storm reports. Lightning data presents obvious advantages for forecasting thunderstorm intensity/severity. Private vendors presently provide several lightning data sources, each with their own benefits and limitations. The ProbSevere team is working to incorporate data from the Earth Networks Total Lightning Network (ENTLN) over CONUS. However, the ENTLN performance varies geographically, and the non-uniformity is most pronounced between CONUS and OCONUS. The Global Lightning Dataset 360 (GLD360) generally outperforms the ENTLN over the oceans and provides more consistent coverage overall. The proposed research seeks to investigate how to best incorporate lightning data into the ProbSevere model, and investigate its potential as a severe storm report proxy in the OCONUS. This seed funding will support closer coordination between different areas of expertise within STAR/CoRP on a visible and impactful forecasting tool. The project includes contributions from three STAR/CoRP scientists at three Cooperative Institutes (CIs).

### **Milestones with Summary of Accomplishments and Findings**

- *Advise CICS-MD as they implement the ProSevere components.*  
Travel has been arranged for a CIMSS researcher to install the ProbSevere code on a CICS-MD server and teach users how to run the code and use its output. The ProbSevere code is also being optimized for better usability and portability for end-users.
- *Contribute data and insights from the ENTLN ProbSevere analyses.*  
Analyses have been performed to test the impact of different aspects of the ENTLN data, including the Lightning Jump Algorithm (LJA), different flash rates, and different percentiles of flash density. The best performing metric was chosen to incorporate into the ProbSevere model for 2016, and these analyses will be shared with CICS-MD. However, GLD360 data may also be later evaluated, pending conversations with NOAA and university experts at CICS-MD.

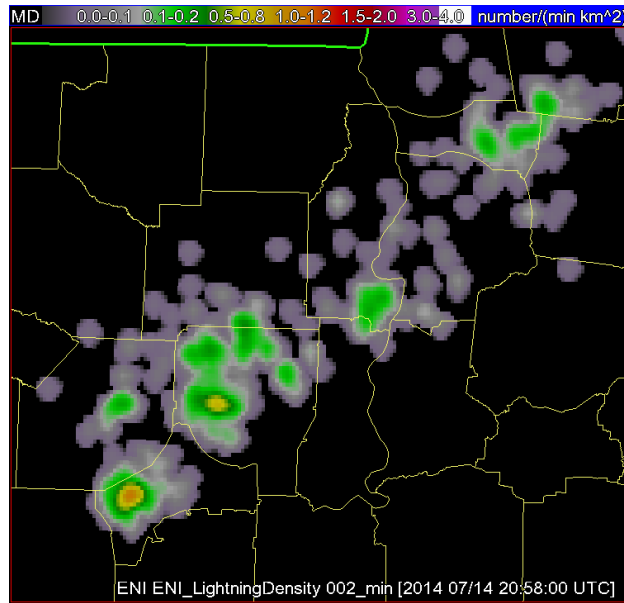

**Figure 83.** A smoothed representation of ENI total lightning flash density (units of flashes  $\text{min}^{-1} \text{km}^2$ ). This field was extracted from within the bounds of radar-identified and tracked storm objects, and used to train n

### **Publications and Conference Reports**

Pavolonis, M. J., J. L. Cintineo, and J. M. Sieglaff, 2016: The NOAA/CIMSS ProbSevere Model – Integration of NWP, Satellite, Lightning, and Radar data for Improved Severe Weather Warnings. 12th Annual Symposium on New Generation Operational Environmental Satellite Systems, New Orleans, LA, 8.2

### **References**

Cintineo, J. L., M. J. Pavolonis, J. M. Sieglaff, and D.T. Lindsey, 2014: An empirical model for assessing the severe weather potential of developing convection. *Weather and Forecasting.*, 29, 639-653.

Cintineo, J. L., M. J. Pavolonis, J. M. Sieglaff, and A. K. Heidinger, 2013: Evolution of severe and non-severe convection inferred from GOES-derived cloud properties. *J. Appl. Meteorol. Climatol.*, 52, 2009-2023.

Sieglaff, Justin M., D. C. Hartung, W. F. Feltz, L. M. Counce, V. Lakshmanan, 2013: A satellite-based convective cloud object tracking and multipurpose data fusion tool with application to developing convection. *J. Atmos. Oceanic Technol.*, 30, 510–525.

### **37.2 EOY Funding: Filling the Gaps in the HIRS Cloud and Moisture Reprocessing**

**CIMSS Task Leader: W. Paul Menzel**

**CIMSS Support Scientist: Richard Grey, Eva Borbas**

**NOAA Collaborator: Mitch Goldberg**

**Budget: \$70K**

### **NOAA Long Term Goals:**

- Climate Adaptation and Mitigation
- Weather-Ready Nation



### **NOAA Strategic Goals:**

- Serve society's needs for weather and water
- Understand climate variability and change to enhance society's ability to plan and respond
- Provide critical support for the NOAA mission

### **CIMSS Research Themes:**

- Satellite Meteorology Research and Applications
- Satellite Sensors and Techniques

### **Objective**

To fill gaps in the HIRS cloud and Moisture data record.

### **Project Overview**

Measurements from 1979 through 2014 from the series of HIRS (High resolution Infrared Radiation Sounder) sensors, that has flown on 16 different polar-orbiting platforms has been started, provide a unique opportunity to record the global cloud and moisture properties from month to month. The HIRS sensors are generally available on both morning and afternoon platforms. Often there are multiple sensors in each orbit, especially in recent years. Thus the inference of cloud properties and total precipitable water (TPW) with HIRS involves analysis of over 80 satellite years, or partial years, of data. The unique feature the HIRS record offers is that it provides the only 40-year satellite-based infrared (IR) measurements in the 4.3- and 15- $\mu\text{m}$  CO<sub>2</sub> absorbing bands and in the 6.7- $\mu\text{m}$  H<sub>2</sub>O absorbing band.

The cloud properties pertinent to this study are the cloud-top pressure (CTP), temperature (CTT), height (CTH), and cloud effective emissivity ( $\epsilon_f$ , which is cloud fraction  $f$  multiplied by cloud emissivity  $\epsilon$ ). These parameters are derived using the 15- $\mu\text{m}$  spectral bands in the CO<sub>2</sub> slicing approach, which is effective for characterizing high altitude, transmissive ice clouds. The moisture properties include TPW and three layers (high, middle, and low) of moisture; the algorithm is a statistical regression developed from the SeaBor data base (Borbas et al. 2005) that consists of geographically and seasonally distributed radiosonde, ozonesonde, and ECMWF ReAnalysis data. TPW are determined for clear sky radiances measured by HIRS over land and ocean both day and night. There is strong reliance on radiances from 6.5, 11, 12  $\mu\text{m}$ . The PATMOS-x cloud mask is used to characterize HIRS sub-pixel cloud cover. Both the cloud and the moisture algorithms have been adopted for operational Moderate resolution Imaging Spectroradiometer (MODIS) measurements (for clouds see Menzel et al. 2008, Baum et al. 2012; for moisture see Seemann et al. 2003, Seemann et al. 2008) from the National Aeronautics and Space Administration (NASA) Terra and Aqua platforms. The specific implementation used for this analysis is patterned after that of MODIS Collection 6.

### **Milestones with Summary of Accomplishments and Findings**

Cloud and moisture records have been completed (see the figures below for the hemispheric records). To accommodate orbit drift, only the operational time periods for the HIRS are included in the time records and the orbit contributions are divided into four segments (with sunlight before and after noon; without sunlight before and after midnight). Major gaps in the HIRS data (pre 1989 from NOAA 6, 7, 8, 9, 10, and 11) have been reduced.

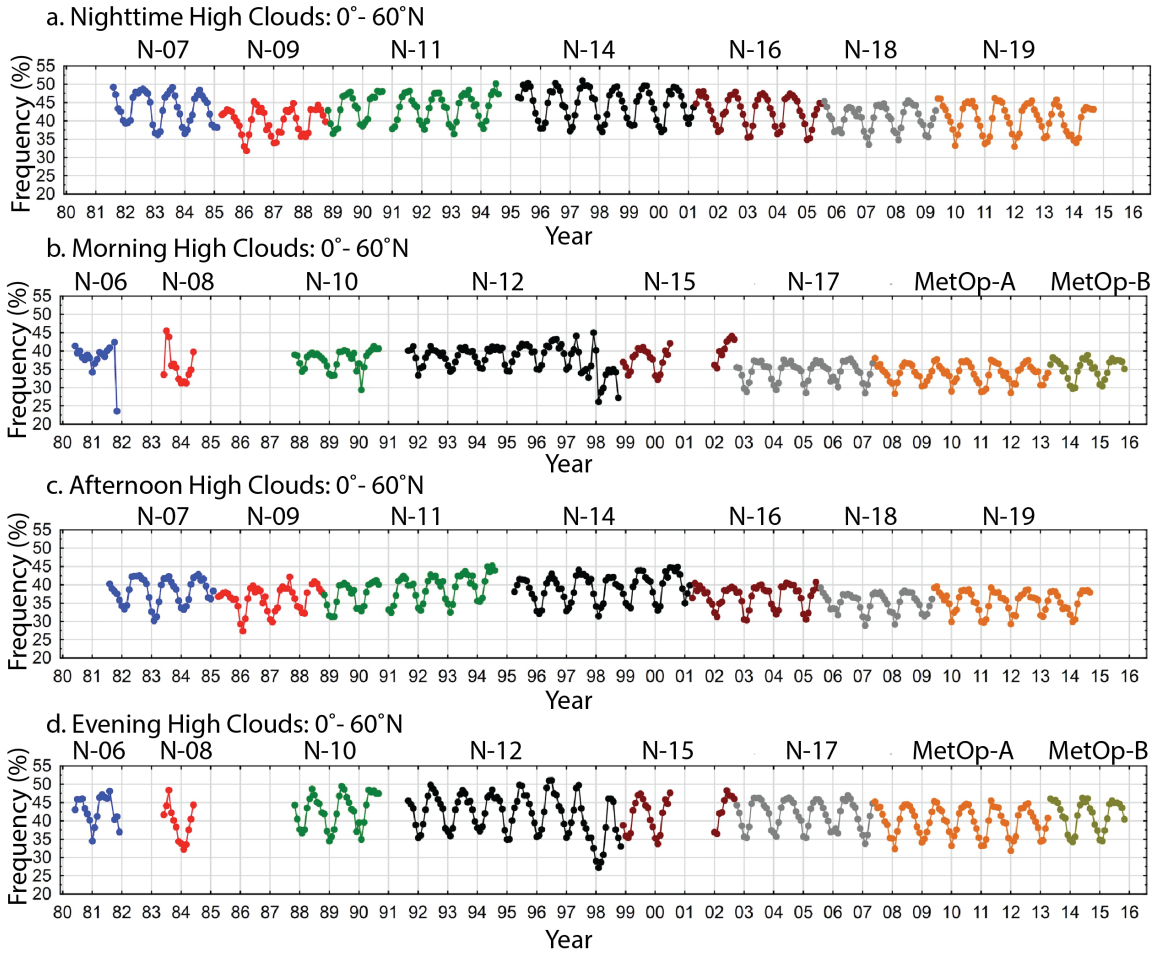

Figure 84. Percentage of HIRS observations that found high clouds in the northern hemisphere 0° to 60°N from 1980 to 2015.

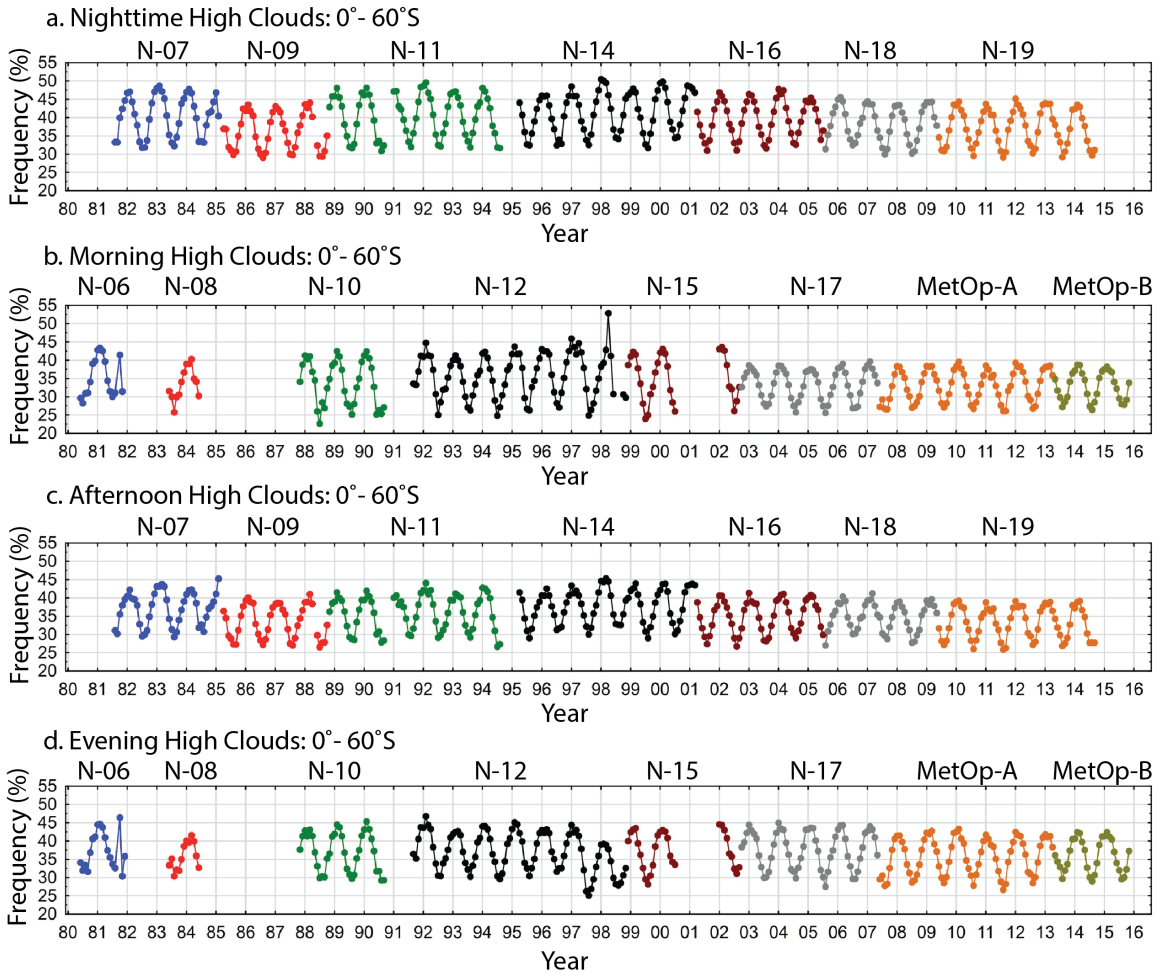

Figure 85. Percentage of HIRS observations that found high clouds in the southern hemisphere 0° to 60°S from 1980 to 2015.



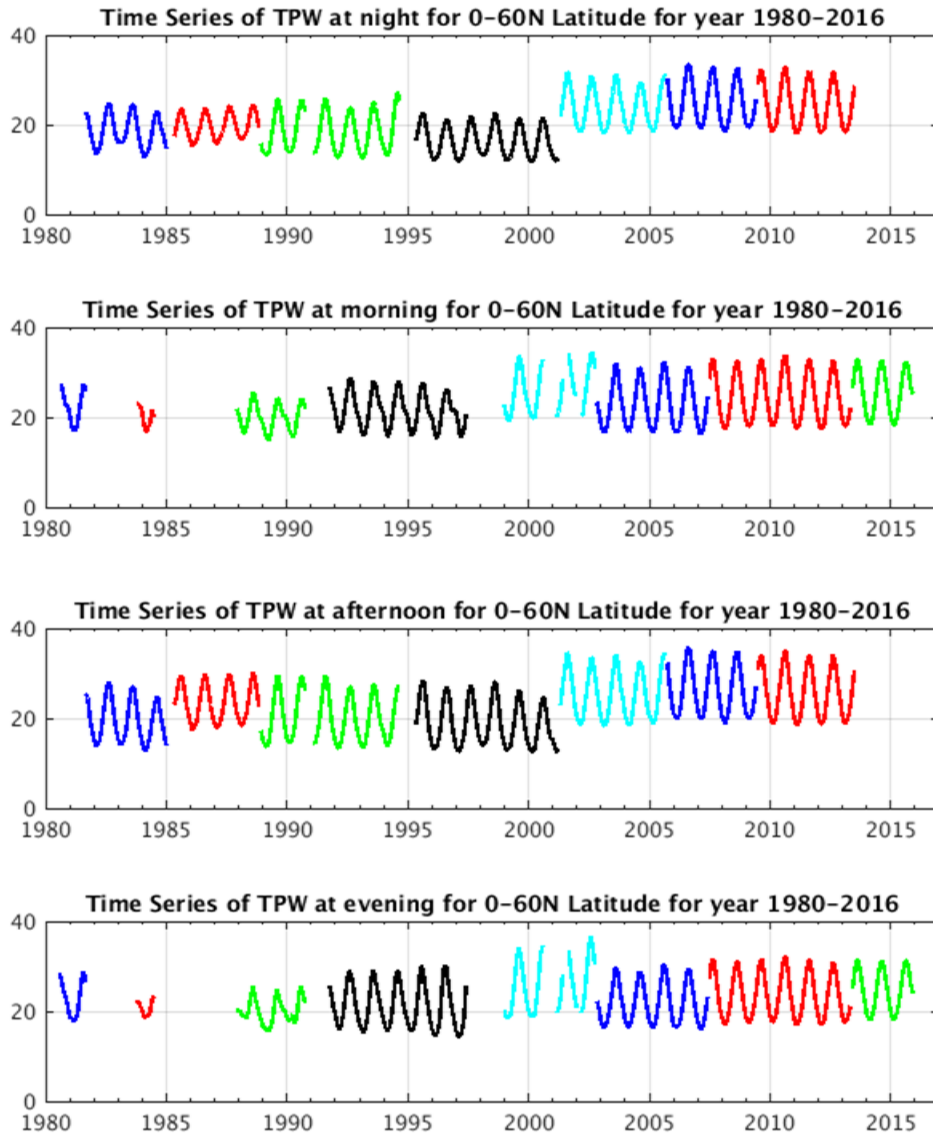

Figure 86. HIRS observations of TPW in the northern hemisphere 0° to 60°N from 1980 to 2015.

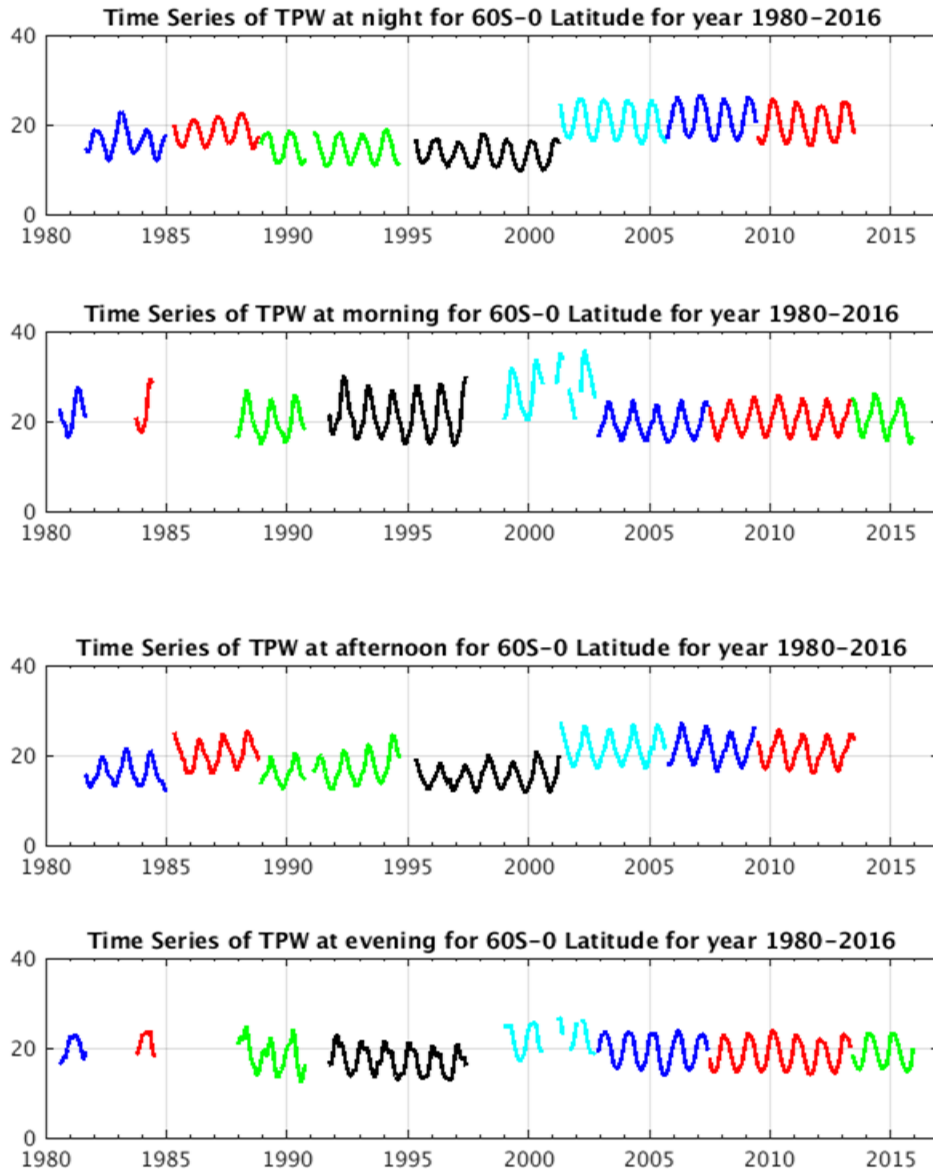

Figure 87. HIRS observations of TPW in the southern hemisphere 0° to 60°S from 1980 to 2015.



Thirty five year trends in detection of high clouds and estimation of total column precipitable water vapor (TPW) have been reprocessed. Results indicate that (1) hemispheric (NH and SH) seasonal high clouds are exactly out of phase, with seasonal high cloud fluctuation greater in SH than NH, (2) TPW is highest in tropics and the seasonal TPW cycle is strongest in northern mid-latitudes and weakest in the tropics, (3) hemispheric seasonal TPW are exactly out of phase, with the seasonal TPW fluctuation greater in NH than SH, and (4) hemispheric seasonal TPW and high clouds are exactly in phase.

## References

- Baum, B. A., W. P. Menzel, R. A. Frey, D. C. Tobin, R. E. Holz, S. A. Ackerman, A. K. Heidinger, and P. Yang, 2012: MODIS cloud top property refinements for Collection 6. *Jour. Appl. Meteor. Clim.*, 51, No. 6, 1145-1163.
- Borbas, E., S. W. Seemann, H.-L. Huang, J. Li, and W. P. Menzel, 2005: Global profile training database for satellite regression retrievals with estimates of skin temperature and emissivity. *Proc. of the Int. ATOVS Study Conference-XIV, Beijing, China, 25-31 May 2005*, pp763-770.
- Menzel, W. P., R. A. Frey, H. Zhang, D. P. Wylie., C. C. Moeller, R. A. Holz, B. Maddux, B. A. Baum, K. I. Strabala, and L. E. Gumley, 2008: MODIS global cloud-top pressure and amount estimation: algorithm description and results. *J. Appl. Meteor. Clim.*, 47, 1175-1198.
- Seemann, S. W., J. Li, W. P. Menzel, and L. E. Gumley, 2003. Operational retrieval of atmospheric temperature, moisture, and ozone from MODIS infrared radiances. *J. Appl. Meteor.*, 42, 1072-1091.
- \_\_\_\_\_, Borbas, E.E., Knuteson, R.O., Stephenson, G.R., and Huang, H-L., 2008: Development of a global infrared emissivity database for application to clear sky sounding retrievals from multi-spectral satellite radiances measurements. *J. Appl. Meteorol. and Clim.* 47, 108-123

## **37.3 Creation and Validation of a Climatology of CAPE and CIN in the U.S. East of the Rockies from JPSS and METOP Polar Sounders**

**CIMSS Task Leader: Robert Knuteson**

**CIMSS Support Scientist: Jessica Gartzke (Undergrad Student)**

**Budget: \$50K**

### **NOAA Long Term Goals:**

- Climate Adaptation and Mitigation
- Weather-Ready Nation
- Resilient Coastal Communities and Economies

### **NOAA Strategic Goals:**

- Serve society's needs for weather and water
- Understand climate variability and change to enhance society's ability to plan and respond
- Support the nation's commerce with information for safe, efficient and environmentally sound transportation
- Provide critical support for the NOAA mission



### **CIMSS Research Themes:**

- Satellite Meteorology Research and Applications
- Satellite Sensors and Techniques
- Environmental Models and Data Assimilation
- Education and Outreach

### **Objective**

This project will produce a useful reference database for NOAA science projects, particularly for the Suomi NPP/JPSS polar orbiting satellite program, by providing a validated CAPE and CIN climatological dataset for use in probabilistic interpretation of convective weather.

### **Project Overview**

This project will produce a useful reference database for NOAA science projects, particularly for the Suomi NPP/JPSS polar orbiting satellite program, by providing a validated CAPE and CIN climatological dataset for use in probabilistic interpretation of convective weather. The funding will be used to analyze ten years of Aqua AIRS data to develop a climatology of the convective indices CAPE and CIN under all weather conditions for the U.S. east of the Rocky mountains. A journal publication will be submitted that describes the dataset and validation in the southern Great Plains region using ARM site radiosondes. The CAPE and CIN climatology from AIRS will be used to assess the same convective indices derived from S-NPP NUCAPS retrievals of temperature and water vapor profile. ECWMF reanalysis fields will also be used to assess the NUCAPS convective indices, esp. spatial coverage gaps. This project will lay the groundwork for potential real-time severe weather applications of JPSS satellite data by developing critical algorithm software compatible with the CSPP direct broadcast capability at SSEC in Madison, WI.

### **Milestones with Summary of Accomplishments and Findings**

Preliminary investigation shows that the satellite products provide timely (late morning and early afternoon) sampling of unstable atmospheres (note the operational NWS upper air soundings are at 6am and 6pm only in the Great Plains region) and accurate. The CAPE and CIN variable are sensitive to vertical resolution however the hyperspectral IR soundings have been shown to reproduce the CAPE and CIN from radiosonde data to within about 10%. The main limitations are areas of overcast clouds where the AIRS (and NUCAPS) algorithm where the vertical resolution is degraded below cloud top. The figure illustrates the CAPE values derived from AIRS temperature and water vapor profiles with the highest CAPE directly west of El Reno, Oklahoma a few hours prior to the tornado touchdown on 31 May 2013.

A climatology of CAPE values derived from Vaisala radiosondes launched at the ARM site near the 1:30 pm local time satellite overpass of Aqua and SNPP has been computed using the SHARPPy software (Halbert et al. 2015; Hart et al. 1999). Detailed comparison of ARM sonde derived CAPE and CAPE computed from ERA model profiles and from AIRS satellite retrievals was performed. A conference paper (Oral and extended abstract) was presented at the Annual AMS meeting in New Orleans.

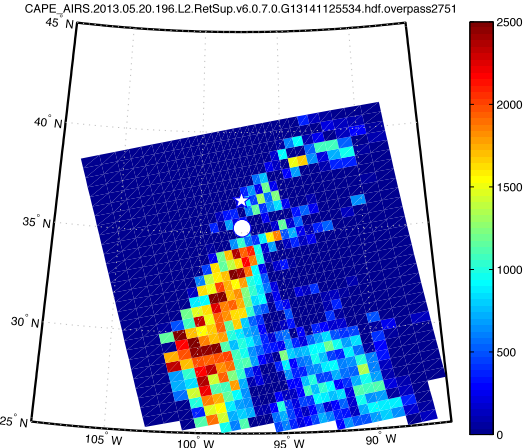
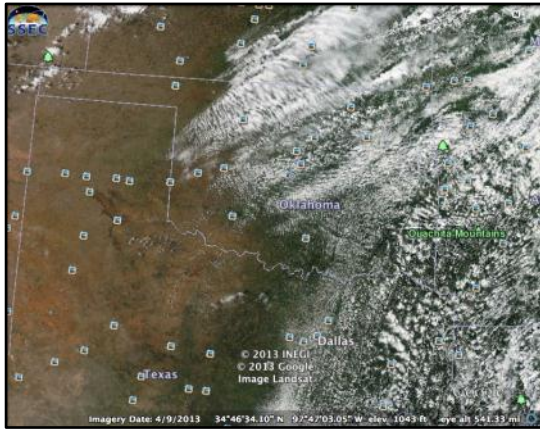

Figure 88. The MODIS satellite image above was taken 4.5 hours before the El Reno event on May 31, 2013. The right panel shows the CAPE value detected by AIRS at the same time. El Reno/Norman Oklahoma is shown as a white dot and the SGP ARM site as a star. (from Gartzke et al. 2015, <https://ams.confex.com/ams/27SLS/webprogram/Paper255450.html>)

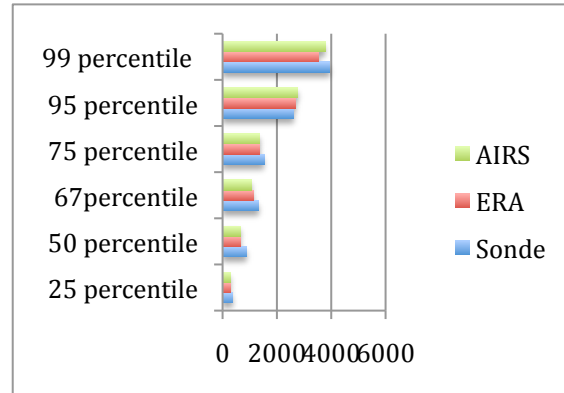
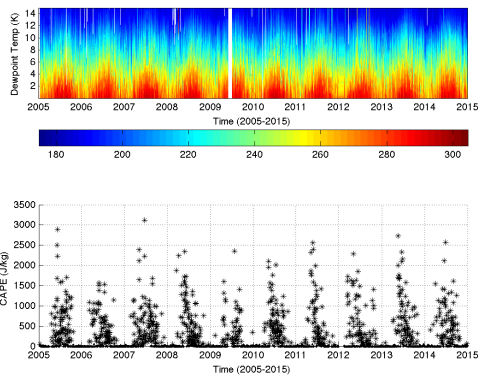

Figure 89. Seasonal variation in dewpoint (left top) and surface CAPE (left bottom) at the ARM SGP site. The right panel is the distribution of CAPE values for AIRS, ERA, and Sonde showing a 10% reduction in CAPE due to lower vertical resolution of the IR sounder profiles.

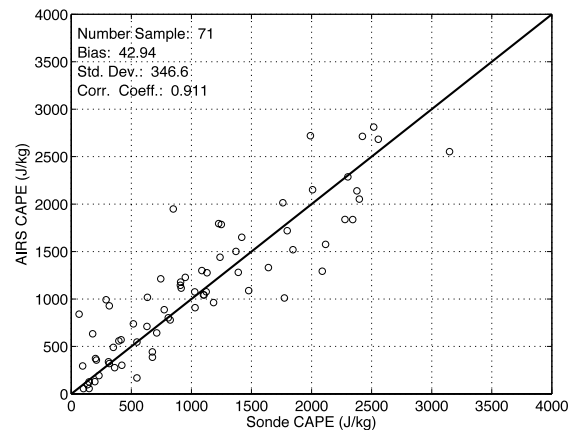
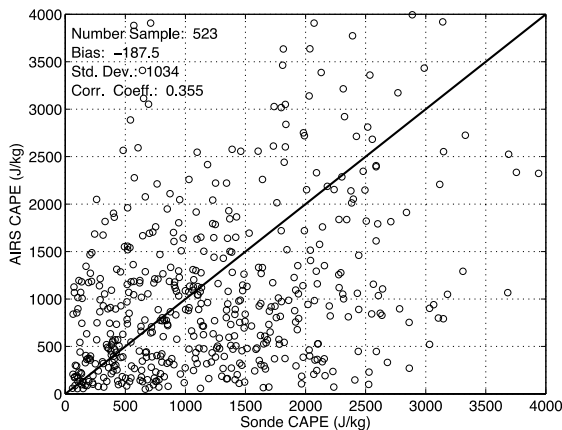

Figure 90. AIRS vs. ARM radiosonde all data with AIRS cloud fraction less than 0.8 (left) and a subset with surface dew point within one degree (right). This implies that the large scatter in the AIRS CAPE is due to errors in the estimate of the surface dewpoint temperature using in the CAPE parcel.



## Findings

1. The lower vertical resolution of IR satellite soundings leads to a bias toward lower CAPE values of about 10% relative to high vertical resolution radiosonde data. The AIRS and ERA have nearly the same bias relative to the DOE ARM site radiosondes.
2. Poor correlation of the CAPE computed from AIRS satellite soundings with CAPE computed from ARM Vaisala soundings was identified to be caused by error in the estimate of the surface parcel. Similar poor correlation was found with the CAPE derived from NWP ERA for the same reason.
3. Similar results have been found with the EUMETSAT IASI version 6 product.
4. The use of ASOS station surface observations was found to improve the CAPE estimates suggesting that the satellite profiles merged with surface observations will provide a significant improvement in the near-real time estimate of CAPE from IR sounders, e.g. the NUCAPS product from the CrIS sounder on Suomi-NPP.

## Accomplishments

- The AIRS CAPE was evaluated to assess observations at 1:30pm daily.
- The METOP IASI CAPE was evaluated to provide observations at 10:30 am.
- Progress has been made with the use of ASOS data for improving satellite CAPE estimates in near real-time over the Eastern U.S..
- This work was reported at the AMS annual meeting in January 2016.
- A journal publication was submitted with the key findings of this work (listed below)

## Publications and Conference Reports

- Gartzke et al. 2016, TEN YEAR CLIMATOLOGY OF CAPE OBSERVATIONS EAST OF THE ROCKY MOUNTAINS FROM HYPERSPECTRAL IR SOUNDERS, AMS Annual Meeting, New Orleans, January 2016.  
<https://ams.confex.com/ams/27SLS/webprogram/Paper255450.html>
- Gartzke et al 2016, COMPARISON OF SATELLITE, MODEL, AND RADIOSONDE DERIVED CONVECTIVE AVAILABLE CONVECTIVE ENERGY (CAPE) IN THE SOUTHERN GREAT PLAINS REGION, Journal of Applied Meteorology and Climatology (in review).

## References

Halbert, K. T., W. G. Blumberg, and P. T. Marsh, 2015: SHARPPy: Fueling the Python Cult. *Prepr. 5th Symp. Adv. Model. Anal. Using Python*, 1–3.

Hart, J. A., J. Whistler, R. Lindsay, and M. K., 1999: NSHARP, version 3.10. *Storm Predict. Center, Natl. Centers Environ. Predict.*.

## 37.4 Stratospheric Warming and Tropospheric Cold Pool Studies Using NUCAPS/AIRS and GPS RO

**CIMSS Task Leader: Robert Knuteson**

**CIMSS Support Scientist: Michelle Feltz**

**Budget: \$50K**

## NOAA Long Term Goals:

- Climate Adaptation and Mitigation
- Weather-Ready Nation



### **NOAA Strategic Goals:**

- Serve society's needs for weather and water
- Understand climate variability and change to enhance society's ability to plan and respond
- Support the nation's commerce with information for safe, efficient and environmentally sound transportation
- Provide critical support for the NOAA mission

### **CIMSS Research Themes:**

- Satellite Meteorology Research and Applications
- Satellite Sensors and Techniques
- Environmental Models and Data Assimilation
- Education and Outreach

### **Objective**

The use of near-real time RO data will be studied to see whether it can provide a precise definition of the lower boundary of the cold pool region to complement the horizontal coverage provided by the IR sounder

### **Project Overview**

This project will validate the use of IR hyperspectral retrievals of temperature in the middle troposphere through the stratosphere using COSMIC and GRAS dry temperature profiles obtained from GPS Radio Occultation. A particular emphasis will be placed on Northern Hemisphere high latitudes where commercial aircraft routinely operate between the U.S. and Asia and the U.S. and Europe. This project will complement existing JPSS PGRR projects to use AIRS, CrIS, and IASI infrared sounding profiles in support of the NWS Alaska forecasts of the "cold pool" affecting aircraft operating at about 30,000 foot altitude. This project will quantify the temperature accuracy and the vertical resolution of the IR sounder vertical profiles from the NUCAPS and AIRS algorithms using GPS RO profiles from COSMIC and GRAS. In addition, **the use of near-real time RO data will be studied to see whether it can provide a precise definition of the lower boundary of the cold pool region to complement the horizontal coverage provided by the IR sounder.** This work builds upon two publications from CIMSS graduate student Michelle Feltz which describe the methodology used in the GPS RO and MW/IR Sounder comparison and results comparing COSMIC RO profiles with soundings from AIRS, IASI, and CrIS (Feltz et al. JGR 2014; Feltz et al. AMT 2014).

### **Milestones with Summary of Accomplishments and Findings**

Milestones:

- Oral presentation and extended abstract at the AMS 2016 Annual Meeting in New Orleans, LA in January 2016 by M. Feltz.
- Coordination with JPSS polar aviation working group in support of NWS Alaska.

Finding #1. The GPS RO Temperature profile has the vertical resolution to identify the lower boundary of the Cold Air aloft and to capture the coldest air temperatures within the cold pool. The IR sounder data under-estimates the cold air temperatures due to lower vertical resolution.

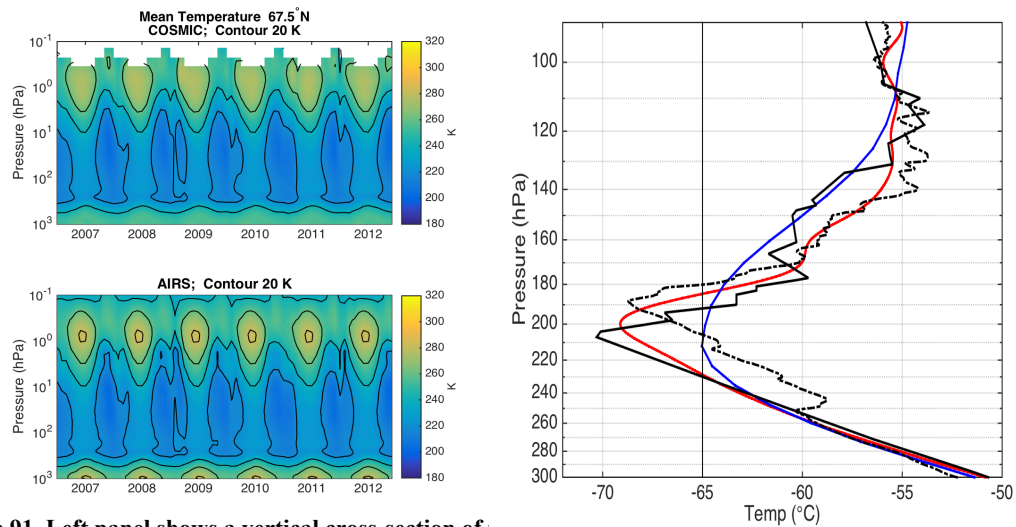

**Figure 91.** Left panel shows a vertical cross-section of mean temperature at 67.5°N from 2007 to 2012 for COSMIC (top) and AIRS (bottom). Right panel is an example showing how the higher vertical resolution of the COSMIC data can be used to determine the precise lower boundary of the cold air aloft. Overlaid temperature profiles from an example COSMIC (red), AIRS (blue), NWS sonde (solid black), and ARM sonde (dashed black) matchup over the Barrow, AK ARM site on 24 Feb 2014.

**Finding #2.** The GPS RO Temperature profiles only sparsely sample the Alaska region whereas the IR sounder cross-track scanning provides good characterization of the spatial extent of the Cold Pool. The GPS RO provides sampling throughout the diurnal cycle while the IR sounders sample at fixed times per day.

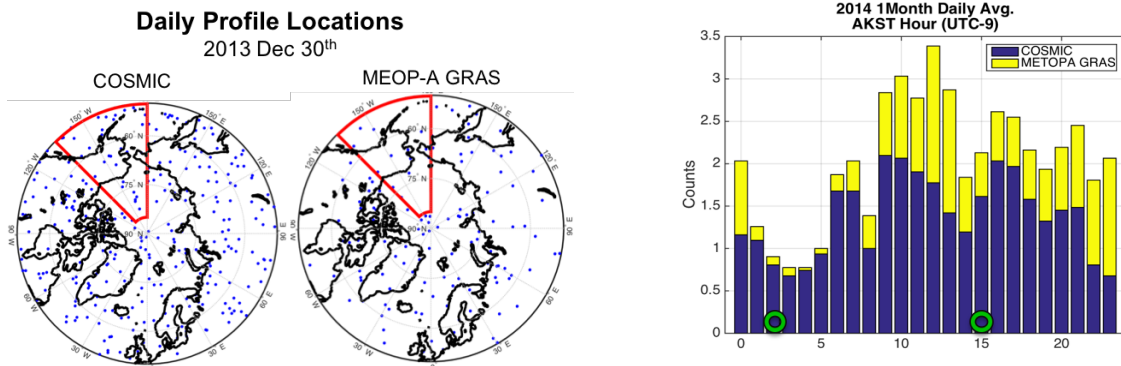

**Figure 92.** (left) Spatial coverage of the two GPS RO systems considered in this study. (right) A bar graph of the daily average number of profiles from COSMIC and METOP-A GRAS for each AK Standard Time hour over the month of January 2014 for the AK region defined by red boxes in Fig 7. NWS 00Z and 12Z radiosonde launch times are marked by green circles. (Right) Subjective evaluation of various measurement systems contributions to cold air aloft over the Alaska region.

**Finding #3.** The GPS RO Temperature profiles are more consistent with GFS model temperatures than the NUCAPS product which shows a seasonally varying bias. This suggests that GPS RO can be used to improve the estimates of the temperature of cold air aloft.



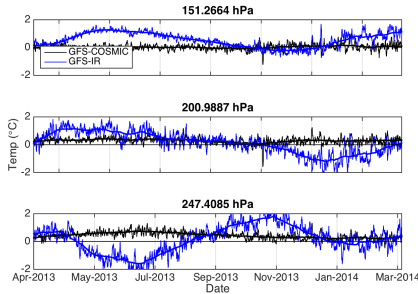

	HYPERSPECTRAL IR SOUNDERS	RADIO OCCULTATION	RADIOSONDES
VERTICAL RESOLUTION	Fair	Good	Good
HORIZONTAL COVERAGE	Good	Poor	Poor
TIME FREQUENCY	Fair	Fair	Poor

**Figure 93. (Left) Overview GFS-COSMIC and GFS-NUCAPS monthly and daily averaged temperature biases for 60°N-90°N at 3 different pressure levels showing seasonal biases in the NUCAPS product relative to both GFS and GPS RO. (Right) Subjective evaluation of various measurement systems contributions to cold air aloft over the Alaska region.**

**Accomplishment.** An evaluation of the relative merits of Hyperspectral IR Sounders, Radio Occultation, and Radiosondes was performed and the results are summarized in a table. The use of RO profiles in the real-time observational detection of cold air aloft in the Alaska region is recommended to provide a quality check on the IR sounding profiles, improve the estimate of the lower boundary of the cold air aloft, and improve the estimate of the minimum air temperature in the cold pool.

### Publications and Conference Reports

Towards Aiding Aviation Safety: Detection of Cold Air Aloft Using COSMIC RO and AIRS Hyperspectral IR Sounder, Michelle Feltz, Robert Knuteson, Elisabeth Weisz, Nadia Smith, Wayne Feltz, Steve Ackerman, AMS Annual Meeting, New Orleans, January 2016, <https://ams.confex.com/ams/96Annual/webprogram/Paper282900.html>

### References

- Feltz, M. et al., 2014a: A methodology for the validation of temperature profiles from hyperspectral infrared sounders using GPS radio occultation: Experience with AIRS and COSMIC, JGR, doi:10.1002/2013JD020853.
- Feltz, M et al., 2014b: Application of GPS radio occultation to the assessment of temperature profiles from microwave and infrared sounders, AMT.
- Kursinski, E.R., Hajj, G.A., Schofield, J.T., Linfields, R.P. and Hardy, K.R. 1997: Observing Earth's atmosphere with radio occultation measurement using the Global Positioning System. J. Geophys. Res., 102, 23,429-23,465.
- Smith, N. et al., 2015: Novel applications of temperature soundings in high latitude regions—Aviation in Alaska, ITSC-20, 28 Oct – 03 Nov, Lake Geneva, WI.
- Stevens, Eric. et al., 2015: Using Hyperspectral Sounders to Detect Cold Air Aloft over Alaska, Annual AMS 04 - 08 Jan, Phoenix, AZ.
- Weisz, E. et al., 2015: Assessing hyperspectral retrieval algorithms and their products for use in direct broadcast applications, ITSC-20, 28 Oct - 03 Nov, Lake Geneva, WI.



## **38. CIMSS Participation in Sensing Hazards with Operational Unmanned Technology (SHOUT)**

**CIMSS Task Leader: Chris Velden**

**CIMSS Support Scientists: Derrick Herndon, Sarah Griffin**

**NOAA Collaborator: Gary Wick (ESRL)**

**Budget: \$62,000**

### **NOAA Long Term Goals:**

- Weather-Ready Nation

### **NOAA Strategic Goals:**

- Serve society's needs for weather and water
- Provide critical support for the NOAA mission

### **CIMSS Research Themes:**

- Satellite Meteorology Research and Applications

### **Objective**

Provide tailored satellite data and products for weather hazard avoidance during SHOUT Global Hawk science and data collection missions.

### **Project Overview**

The CIMSS team has a strong history of supporting scientific field campaigns with crucial meteorological satellite data and tailored products. The CIMSS expertise extend into developing, interpreting and utilizing these satellite products to support research aircraft hazard avoidance, as well as general mission and project research analyses. The PI and his team have participated in many recent projects, including NASA's HS3 field campaign that also utilized the Global Hawk. Many of these were in very successful collaborations with NOAA and NESDIS. We have been asked by NOAA to collaborate and provide support for the upcoming 2015 SHOUT program. The field campaign will operate at times in a tough environment for aircraft reconnaissance, and the over-ocean nature will mean that real-time satellite data/products from a variety of platforms will be crucial to mission planning and safety. CIMSS can provide these satellite data in a timely manner to the project, and tailor the derived products to fit the needs of SHOUT.

### **Milestones with Summary of Accomplishments and Findings**

#### Milestone 1: Provide support for the SHOUT field campaign.

The SHOUT field campaign ran from Aug-Sept. 2015, encompassing many science missions with the Global Hawk. Since the primary targets of these missions were tropical cyclones, the airplane was operating in conditions that posed unique challenges in many ways. Remote-sensing imagery and derived products were crucial to successful mission planning, decision-making, and execution, and CIMSS made this data available to the mission operations center in real time from multiple satellite platforms, tailored specifically to the SHOUT region of interest.

CIMSS scientists also brought their expertise to the operations center, providing product training and also as mission support scientists. The CIMSS PI has extensive experience supporting field projects, and has often collaborated with NOAA in support of mission and forecast operations. Satellite data product development and interpretation added a key element to the mission planning through the CIMSS team expertise in this area. Examples of specific real-time CIMSS tailored satellite products made available for the field campaign were:



- High-density wind vectors from GOES processed at hourly intervals;
- Diagnostic fields (shear, divergence, vorticity) from these wind vector fields;
- Cloud-Top Heights using latest NESDIS algorithms;
- Overshooting Tops identification; and
- TPW analyses using the CIMSS MIMIC algorithm (continuously updating with seamless animation).

Specific tasks accomplished were:

- Provided 24/7 support of CIMSS satellite-derived products for real-time use during the field campaign missions,
- Derived meteorological variables from satellite data to help meet mission requirements and the research goals of SHOUT, and
- Participated in the SHOUT planning meetings.

### **39. Support for the NOAA Cloud Climate Data Records**

**CIMSS Task Leader: Michael Foster**

**CIMSS Support Scientist: Michael Hiley**

**NOAA Collaborator: Andrew Heidinger**

**Budget: \$156,000**

#### **NOAA Long Term Goals:**

- Climate Adaptation and Mitigation
- Weather-Ready Nation

#### **NOAA Strategic Goals:**

- Serve society's needs for weather and water
- Understand climate variability and change to enhance society's ability to plan and respond
- Provide critical support for the NOAA mission

#### **CIMSS Research Themes:**

- Satellite Meteorology Research and Applications
- Satellite Sensors and Techniques

#### **Objective**

Our primary objective is to support research-to-operations for NOAA's National Center for Environmental Information (NCEI) Climate Data Record (CDR) program. This is done through the near real-time delivery of the Pathfinder Atmospheres – Extended (PATMOS-x) AVHRR Reflectance Fundamental CDR (FCDR) and Cloud Properties Thematic CDR (TCDR), including the provision of quality assurance and periodic updating of calibration.

#### **Project Overview**

During previous reporting periods major tasks completed include the following:

- Bulk delivery of the entire PATMOS-x CDR. The AVHRR Reflectance FCDR record begins in 1978 while the AVHRR Cloud Properties TCDR begins in 1981, and both exist through present;
- Establish a mechanism of automated delivery to NCDC of near real-time FCDR and TCDR records as they become available;
- Delivery of reports, source code, ancillary data sets, and supporting documentation; and



- Development of a combined AVHRR + HIRS Cloud TCDR derived from the PATMOS-x AVHRR FCDR and the Menzel HIRS FCDR.

### Milestones with Summary of Accomplishments and Findings

In addition to providing quality assurance and general support, to maintain stability spanning over a dozen AVHRR sensors the visible channels require an inter-calibration process using stable earth targets, AVHRR-to-AVHRR SNOs, and AVHRR-to-MODIS SNOs (Heidinger et al. 2010). The switch from MODIS Collection 5 to Collection 6 complicated the inter-calibration performed during this reporting period. The process has been completed and analysis is being performed to characterize differences and effects on the PATMOS-x CDR.

Development of the AVHRR + HIRS TCDR is nearing completion. Milestones include:

1. Collocation of HIRS and AVHRR measurements and products,
2. Modification of the clavr-x processing system to process HIRS data,
3. Negotiation of the differing footprint and measurement spacing of the AVHRR and HIRS sensors,
4. Integration of the HIRS information into the AVHRR-based cloud detection and height algorithms, and
5. Generation of a full level2b merged AVHRR/HIRS record spanning 1979 – present.

Milestones 1-4 are complete. During this reporting period analysis of several years of AVHRR/HIRS PATMOS-x data was performed with the goal of characterizing the results and identifying shortcomings to be addressed. We expect this to be an iterative process whereas the end results is a consistent record spanning 1979 – present. Improved cloud detection over Polar Regions is one of the anticipated benefits of incorporating spectral information from the HIRS instrument. Figure 94 shows the difference in global cloud fraction produced by the PATMOS-x AVHRR/HIRS record versus AVHRR-only for the NOAA-19 satellite. Encouragingly the largest differences in cloudiness do occur over the Polar Regions.

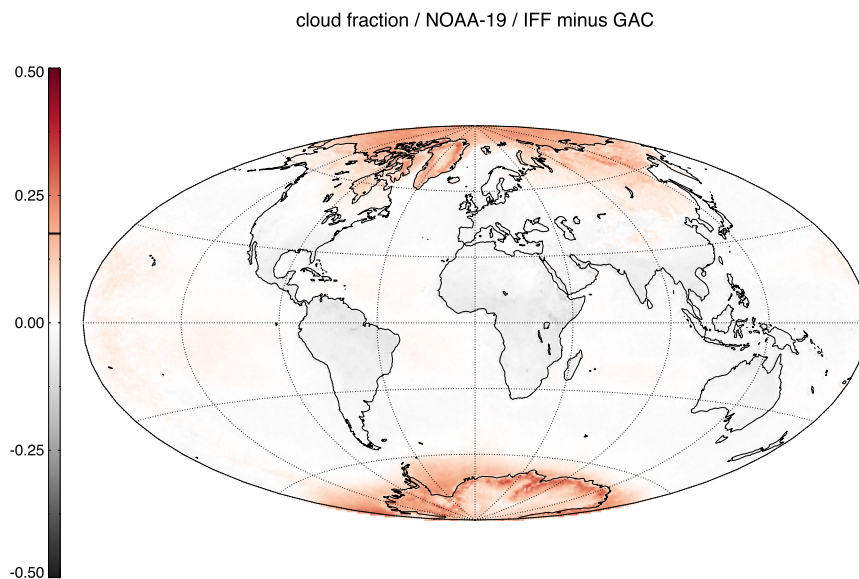

**Figure 94. Mean cloud fraction difference for the entire NOAA-19 PATMOS-x record calculated as IFF (AVHRR + HIRS) minus GAC (AVHRR-only).**



## Publications and Conference Reports

Foster, M. J., A. K. Heidinger, M. Hiley, S. Wanzong, A. Walther and D. Botambekov, 2016: PATMOS-x Cloud Climate Record Trend Sensitivity to Reanalysis Products. *Remote Sensing – Submitted*.

Heidinger, A. K., M. J. Foster, D. Botambekov, M. Hiley, Y. Li and A. Walther, 2016: Using the NASA EOS A-Train to Probe the Performance of the NOAA PATMOS-x Cloud Fraction CDR. *Remote Sensing – Submitted*.

“Characterizing Long-Term Stability in the PATMOS-x Record,” EUMETSAT conference, Toulouse, France, September, 2015.

## References

Heidinger, A. K., M. J. Foster, A. Walther and X. Zhao, 2013: The Pathfinder Atmospheres Extended (PATMOS-x) AVHRR Climate Data Set. ”]. *Bull. Amer. Meteor. Soc.*, doi: <http://dx.doi.org/10.1175/BAMS-D-12-00246.1>

Heidinger, A.K., Straka III, W.C., Molling, C.C., Sullivan, J.T. and Wu, X., 2010, Deriving an inter-sensor consistent calibration for the AVHRR solar reflectance data record. *International Journal of Remote Sensing*.

## 40. CIMSS support for Aura Chemical Reanalysis in Support of Air Quality Applications (NASA)

**CIMSS Task Leader: Allen Lenzen**

**CIMSS Support Scientist: Monica Harkey**

**NOAA Collaborator: R. Bradley Pierce (NOAA/NESDIS)**

**Budget: \$133K**

### NOAA Long Term Goals:

- Climate Adaptation and Mitigation
- Weather-Ready Nation
- Resilient Coastal Communities and Economies

### NOAA Strategic Goals:

- Serve society’s needs for weather and water
- Provide critical support for the NOAA mission

### CIMSS Research Themes:

- Satellite Meteorology Research and Applications
- Environmental Models and Data Assimilation

### Objective

Provide the air quality community with a multi-year global chemical and aerosol reanalysis using NASA Aura and A-Train measurements.

### Project Overview

We will provide the air quality community with a multi-year global chemical and aerosol reanalysis using NASA Aura and A-Train measurements. We will also conduct regional chemical



data assimilation experiments to quantify the influences of changes in NO<sub>x</sub> emissions on US air quality during the Aura period.

### **Milestones with Summary of Accomplishments and Findings**

- Implemented assimilation of OMI NO<sub>2</sub> into the GSI.
- Developed software to convert OMI TNO<sub>2</sub> to GSI BUFR format.
- Adapted DTC regional MODIS AOD assimilation capabilities for use within RAQMS/GSI analysis system.
- Currently evaluating the AOD assimilation through comparisons with CALIPSO aerosol extinction measurements.
- Implemented assimilation of AIRS CO into GSI.
- Testing Version 5.1 of Community Multi-scale Air Quality (CMAQ) modeling system for conducting 2011 regional OMI NO<sub>2</sub> data assimilations studies.

During this reporting period we adapted the NCEP Gridpoint Statistical Interpolation (GSI) analysis system (Kleist et al. 2009) to also assimilate OMI cloud cleared tropospheric NO<sub>2</sub> (TNO<sub>2</sub>) column retrievals and conducted a number of data denial experiments to optimize the assimilation of OMI NO<sub>2</sub> retrievals within the Real-time Air Quality Modeling System (RAQMS, Pierce, et al. 2007) GSI analysis system. The OMI NO<sub>2</sub> observation operator, which accounts for the scattering weights in the OMI NO<sub>2</sub> slant column retrieval and applies the air-mass factor (AMF) correction to account for surface reflectance, clouds, assumed NO<sub>2</sub> profile shape, and topography, was implemented within GSI and assimilation experiments were conducted to optimize the OMI TNO<sub>2</sub> column assimilation. We focused on July 2010 for these experiments to assess the impact of tropospheric NO<sub>2</sub> column assimilation on surface ozone during the period of peak North American surface ozone production. Figure 95 shows the July 2010 mean TNO<sub>2</sub> from the Aura Reanalysis. Elevated TNO<sub>2</sub> is found over the major industrialized regions (Europe, SE Asia, India, and the Continental US) as well as in regions of significant biomass burning (Africa, Siberia, Central America). The difference (assimilation-control) in TNO<sub>2</sub> column (not shown) due to assimilation of the OMI retrievals shows that slight reductions in TNO<sub>2</sub> column are found over the industrialized regions of the northern Hemisphere, suggesting that the HTAP NO<sub>x</sub> emission inventory is slightly high. Increases in TNO<sub>2</sub> columns are found at high latitudes of the northern Hemisphere and over the Pacific Islands. The largest reductions are found within the regions of biomass burning over Africa and South America suggesting that the RAQMS equatorial biomass burning NO<sub>x</sub> emission estimates are high. Since the GSI analysis system is a 3D-variational scheme we are not able to directly adjust the RAQMS NO<sub>x</sub> emissions. However, based on these assimilation experiments and also on comparisons between RAQMS and AIRS CO column retrievals, we have revised our biomass burning emissions by limiting the intensity of biomass burning in equatorial savanna regions to moderate, which will reduce the NO<sub>x</sub> and CO emissions in these regions.

Figure 96 shows the change in total column ozone (TCO) due to assimilation of the OMI TNO<sub>2</sub> column retrievals during July 2010. The largest response is downwind from the major NO<sub>x</sub> sources with overall reductions in TCO over Arctic and within Oceanic high pressure systems. The largest increase is over Gulf of Mexico and South of Atlantic High pressure system. These OMI TNO<sub>2</sub> column assimilation experiments show that, in spite of not being able to directly constrain the NO<sub>x</sub> emissions, the RAQMS/GSI analysis system shows a systematic remote response in TCO that needs to be accounted for within the Aura Reanalysis.



Tropospheric Column NO<sub>2</sub> (mol/cm<sup>2</sup>) July 2010  
(ASSIM.HTAPEMISS.GSINO2)

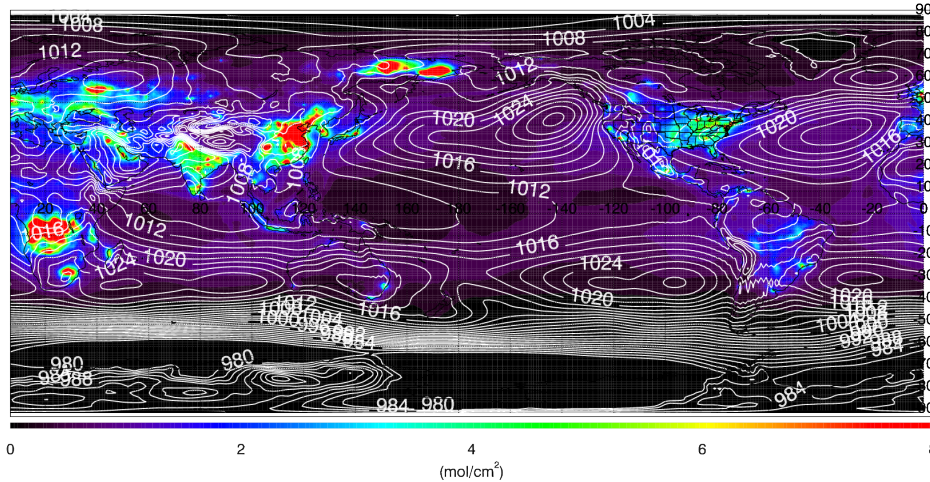

Figure 95. July 2010 Tropospheric NO<sub>2</sub> Column (10\*\*15 mol/cm<sup>2</sup>) from the RAQMS/GSI Aura Reanalysis. White contours show mean sea level pressure.

Change in Tropospheric Ozone Column (DU) July 2010  
(ASSIM.HTAPEMISS.GSINO2 - CONTROL)

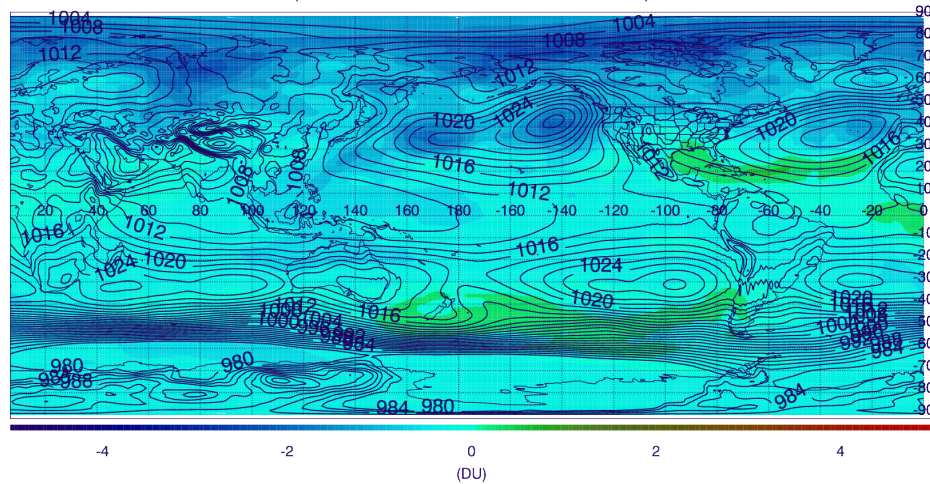

Figure 96. Change in July 2010 Tropospheric Ozone Column (DU) (assimilation-control) within the RAQMS/GSI Aura Reanalysis due to assimilation of OMI TNO<sub>2</sub> retrievals. Blue contours show mean sea level pressure.

### Publications and Conference Reports

“Nested Global and Regional Scale Modeling of the Impacts of Intercontinental Pollution Transport and Stratospheric Intrusion on Surface Air Quality in the Western US”, by R. Bradley Pierce, Todd Schaack, Allen Lenzen, Andrew Wentland, Georg Grell, Steve Peckham, Emma Yates, Laura Iraci, Thomas McGee, John Sullivan, Meteorology And Climate - Modeling for Air Quality (MAC-MAQ), September 16-18 2015, Sacramento, CA

“Development of an Aura Chemical Reanalysis in support Air Quality Applications”, by R. Bradley Pierce (NOAA/NESDIS/STAR), Allen Lenzen, Todd Schaack (UW-Madison SSEC) at the Fall AGU 2015: Data Assimilation and Inverse Modeling for Atmospheric Composition Applications Session. December 14-19, 2015, San Francisco, CA



## References

Kleist, D. T., et al., (2009) Introduction of the GSI into the NCEP Global Data Assimilation System. *Wea. Forecasting*, 24, 1691–1705. doi: <http://dx.doi.org/10.1175/2009WAF2222201.1>

Pierce, R. B., et al., (2007) Chemical data assimilation estimates of continental U.S. ozone and nitrogen budgets during the Intercontinental Chemical Transport Experiment–North America, J. *Geophys. Res.*, 112, D12S21, doi:10.1029/2006JD007722.

## 41. CIMSS Participation in SHyMet for 2015

**CIMSS Task Leader: Steve Ackerman**

**CIMSS Support Scientists: Scott Lindstrom, Scott Bachmeier**

**NOAA Collaborators: Tim Schmit, Tony Mostek, Brian Motta**

**Budget: \$150,000**

### NOAA Long Term Goals:

- Weather-Ready Nation

### NOAA Strategic Goals:

- Serve society's needs for weather and water
- Provide critical support for the NOAA mission

### CIMSS Research Themes:

- Satellite Meteorology Research and Applications
- Education and Outreach

## Objective

Assist in design and development of SHyMET course curriculum and teach courses as appropriate.

## Project Overview

CIMSS will further develop the Satellite Hydrology and Meteorology (SHyMet) training course through close collaboration with experts at the Cooperative Institute for Research in the Atmosphere (CIRA) at Colorado State University, Colorado. The role of CIMSS in SHyMet has been to 1) assist in the design and development of each satellite education course curriculum, 2) support the distance education activities component by conducting teaching of the courses as appropriate.

## Milestones with Summary of Accomplishments and Findings

CIMSS Scientists have continued working with CIRA scientists in preliminary planning for SHyMet Courses on GOES-R, Aviation Weather and Winter Weather. In addition, the recent change in the Department of Commerce Learning Management System Vendor required a re-tooling (to SCORM files from Quizmaker) of all SHyMet quizzes. This was accomplished in late 2015. CIMSS scientists also added a NOAA/CIMSS ProbSevere Product module to the SHyMet Severe Course.

Data for case studies/training modules continues to be placed on CIMSS Satellite Blog (<http://cimss.ssec.wisc.edu/goes/blog>); entries include data from MODIS and Suomi NPP VIIRS that can serve as a proxy for GOES-R and JPSS. See, for example, <http://cimss.ssec.wisc.edu/goes/blog/archives/15086> for Winter Weather and





<http://cimss.ssec.wisc.edu/goes/blog/archives/14795> or <http://cimss.ssec.wisc.edu/goes/blog/archives/20850> for Aviation training. Himawari-8 data (<http://cimss.ssec.wisc.edu/goes/blog/archives/category/himawari-8>) is an also excellent proxy for GOES-R and has provided useful data in preparation for GOES-R.

SHyMet has also leveraged AWIPS capabilities that have been further refined at CIMSS. A stable AWIPS platform at CIMSS allows for manipulation of CIMSS-produced datasets, especially GOES-R Products, into formats that are compatible with AWIPS. This allows quick development of training modules using data as it appears before the forecaster in the National Weather Service Forecast Office.

### **Publications and Conference Reports**

Lindstrom, S. S. and A. S. Bachmeier, 2016: Most Popular Blog posts of 2015 from CIMSS. Oral Presentation at 25<sup>th</sup> Symposium on Education, American Meteorological Society, New Orleans, LA, 10-14 January 2016.

Lindstrom, S. S., 2015: Fog and Low Stratus Training Resources: Blogs, Videos and Facts sheets (and how they complement each other), NOAA Satellite Proving Ground/User Readiness Meeting, Kansas City, KS, 15-19 June 2015. (Invited)

Lindstrom, S. S. and A. S. Bachmier, 2015: The Use of Blogs, Twitter and YouTube for outreach at CIMSS. Oral Presentation at 24<sup>th</sup> Symposium on Education, American Meteorological Society, Phoenix, AZ, 4-8 January 2015.

## **42. CIMSS Collaboration with the NWS Operations Proving Ground**

**CIMSS Task Leader: Chad Gravelle**

**CIMSS Support Scientist: Wayne Feltz**

**NOAA Collaborator: Tim Schmit**

**Budget: \$156K**

### **NOAA Long Term Goals:**

- Weather-Ready Nation

### **NOAA Strategic Goals:**

- Serve society's needs for weather and water
- Support the nation's commerce with information for safe, efficient and environmentally sound transportation
- Provide critical support for the NOAA mission

### **CIMSS Research Themes:**

- Satellite Meteorology Research and Applications
- Satellite Sensors and Techniques
- Education and Outreach

### **Objective**

The CIMSS collaboration with the NWS Operations Proving Ground focuses on maximizing analysis and forecast value of geostationary satellite data and products, particularly activities centered on NWS weather forecast office operations to improve forecast and warning services to the nation.



## Project Overview

This project entails activities focused on interactions with NWS forecasters at weather forecast offices to prepare them for new satellite dependent products that will become operational after the launch of the GOES-R satellite series.

## Milestones with Summary of Accomplishments and Findings

The following are recent milestones and accomplishments:

- 4-h GOES-R session for new NWS Science and Operations Officers during the 2015 COMET Mesoscale Analysis and Prediction course was organized and delivered;
- Manuscript submitted to the American Meteorological Society’s Weather, Analysis & Forecasting journal titled “Forecaster Evaluations of High-Temporal Satellite Imagery for the GOES-R Era at the NWS Operations Proving Ground”;
- Operations Proving Ground evaluation on operational applications of multispectral bands for the GOES-R era was coordinated and facilitated; and
- NWS Central and Eastern Region evaluation on the CIMSS ProbSevere Model is currently being coordinated and facilitated.

## Publications and Conference Reports

Gravelle, C. M., J. R. Mecikalski, W. E. Line, K. M. Bedka, R. A. Petersen, J.M. Sieglaff, G. T. Stano, and S. J. Goodman, 2016: Demonstration of a GOES-R satellite convective toolkit to “bridge the gap” between severe weather watches and warnings: An example from the 20 May 2013 Moore, Oklahoma, tornado outbreak. *Bull. Amer. Meteor. Soc.*, **97**, 69–84, doi:10.1175/BAMS-D-14-00054.1.

Gravelle, C. M., K. J. Runk, K. L. Crandall, and D. W. Snyder, 2016: Forecaster evaluations of high-temporal satellite imagery for the GOES-R era at the NWS Operations Proving Ground. *Wea. Forecasting*, In Press.

43<sup>rd</sup> American Meteorological Society Conference on Broadcast Meteorology. Raleigh, NC. *GOES-R Derived Products for Operational Meteorology*. 9 June 2015.

2015 Satellite Proving Ground/User Readiness Meeting. Kansas City, MO. *Preliminary Results from the Operations Proving Ground 1-minute Satellite Imagery Evaluation*. 17 June 2015.

2015 COMET Mesoscale Analysis and Prediction (COMAP) Course. Boulder, CO. *Capabilities of The Next-Generation Geostationary Environmental Satellite System for Operational Meteorology*. 17 July 2015.

2015 High Plains Conference. Goodland, KS. *Capabilities of The Next-Generation Geostationary Environmental Satellite System for Operational Meteorology*. 12 August 2015.

2016 American Meteorological Society Annual Meeting. New Orleans, LA. *Enhancing Impact-Based Decision Support Services in the GOES-R Era*. 13 January 2016.

St. Louis, MO AMS Chapter Local Meeting. *Capabilities of The Next-Generation Geostationary Environmental Satellite System for Operational Meteorology*. St. Louis, MO. 18 February 2016.

St. Louis, MO NWS Forecast Office Visit. St. Louis, MO. 19 February 2016.



Douglas County, KS Emergency Management Severe Weather Symposium. Lawrence, KS.  
*Observing the Initiation and Development of Convection in the GOES-R Era.* 5 March 2016.

### **43. CIMSS Collaboration with the Aviation Weather Center**

**CIMSS Task Leader: Wayne Feltz**

**CIMSS Support Scientist: Amanda Terborg**

**NOAA Collaborator: Jeff Key**

**Budget: \$130,000**

#### **NOAA Long Term Goals:**

- Weather-Ready Nation

#### **NOAA Strategic Goals:** Serve society's needs for weather and water

- Support the nation's commerce with information for safe, efficient and environmentally sound transportation
- Provide critical support for the NOAA mission

#### **CIMSS Research Themes:**

- Satellite Meteorology Research and Applications
- Satellite Sensors and Techniques
- Education and Outreach

#### **Objective**

This project entails activities focused at maximizing the forecast value of geostationary satellite data and products, particularly activities centered on aviation weather impacts to the National Airspace System and improving the safety of flight.

#### **Project Overview**

The Cooperative Institute for Meteorological Satellite Studies (CIMSS) at the University of Wisconsin-Madison is supporting the expanding use of satellite-based aviation weather products by placing a CIMSS research scientist at the Aviation Weather Center in Kansas City, MO. The CIMSS scientist is providing leadership, satellite expertise, and meteorological support for the GOES-R Proving Ground efforts based at the National Weather Service (NWS) Aviation Weather Center (AWC).

Amanda Terborg is working closely with the Aviation Weather team at CIMSS, researchers at the NOAA/NESDIS/STAR and GOES-R Program Office, and the staff at the Aviation Weather Center. The position is with the University of Wisconsin-Madison and the position's duty station is at the Aviation Weather Center in Kansas City, MO.

The position is embedded within the NOAA Aviation Weather Testbed (AWT) at the AWC. The AWT provides the infrastructure and facilities to develop, test and evaluate new and emerging scientific techniques, products, and services. The AWT actively engages in the research-to-operations process by supporting applied research, verifying the quality and scientific validity of new techniques and products, and providing a common venue for both forecasters and researchers to engage in developing and testing state-of-the-art aviation weather services.



## **Milestones with Summary of Accomplishments and Findings**

This project entails activities focused at maximizing the forecast value of geostationary satellite data and products, particularly activities centered on aviation weather impacts to the National Airspace System and improving the safety of flight. The CIMSS research scientist will interact with NWS operational forecasters and NESDIS satellite analysts to prepare them for new satellite dependent products that will become available operationally after the launch of the GOES-R satellite series.

The principal duties of this position are:

- Serve as a “Satellite Liaison” at the AWC, leading GOES-R Proving Ground efforts on satellite based hazardous aviation weather products and demonstrating the unique value of satellite information to forecasters;
- Lead in the GOES-R ground readiness effort at the AWC;
- Collaborate with Alaska Region in support of GOES-R Proving Ground activities at the Alaska Aviation Weather Unit;
- Serve as “implementation expert” for selected planned GOES-R and Himawari products and their proxies;
- Test and validate proposed new satellite dependent products and decision aids for operational forecasters with an emphasis on exploring the value of advanced satellite derived products for observing or predicting aviation hazards (e.g., turbulence, icing, convection, ceiling, visibility, volcanic ash);
- Develop and/or document how these satellite dependent products and decision aids may decrease the impact of weather on the National Airspace System by improving air traffic flow management and enhancing the safety of flight;
- Participate in routine experimental projects serving as the focal point for all satellite centered activities at the AWC;
- Lead in training operational forecasters on new and emerging satellite-based techniques and tools, particularly those for aviation developed or evaluated in the AWT;
- Provide satellite expertise in the logistical support of any special or field excursion experiments, such as the planned AWT Impact Decision Support Experiments (IDSE);
- Bridge satellite-related activities between the FAA’s NextGen Weather Program and the NWS by collaborating with the Aviation Weather Demonstration and Evaluation (AWDE) testbed at the FAA’s Tech Center in Atlantic City, NJ;
- Represent the GOES-R effort within the AWT by contributing to formal scientific publications or attending off-site conferences, symposia, and aviation weather-related outreach events;
- Develop synergy and shared accomplishments with the GOES-R Proving Ground at the Hazardous Weather Testbed (HWT) in Norman, Oklahoma and the NWS Proving Ground at the NWS Training Center (NWSTC) in Kansas City, Missouri; and
- Perform related duties as assigned.

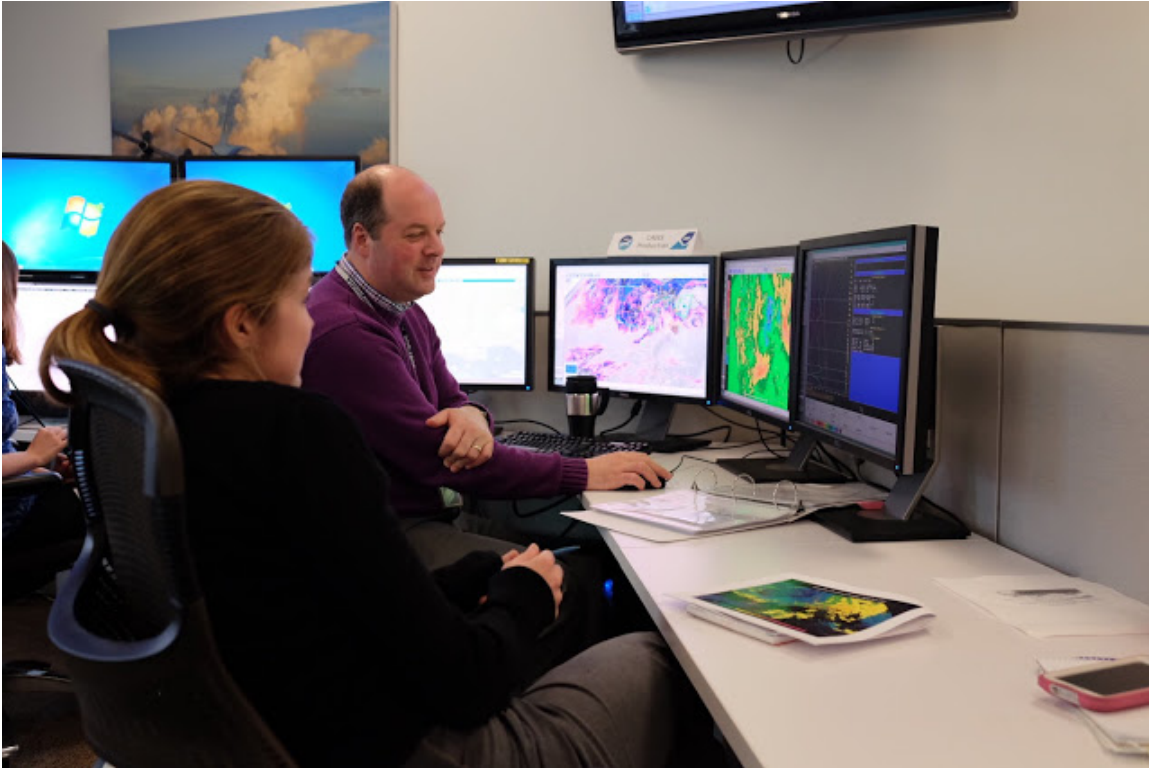

Figure 97. Discussion of satellite related icing products at the non-convective CAWS product desk during the AWT Winter Experiment 2016.

#### **Publications and Conference Reports**

Terborg, Amanda M.; Stano, Geoffrey T., 2016: *Impacts to Aviation Weather Center operations using total lightning observations from the pseudo-GLM*, submitted to *NWA J. Operational Meteorology*.

#### **44. GOES-R Education Proving Ground**

**CIMSS Task Leader: Margaret Mooney**

**CIMSS Support Scientist: Mat Gunshor**

**NOAA Collaborators: Tim Schmit, Steve Goodman, and Nina Jackson**

**Budget: \$80,000**

#### **NOAA Long Term Goals:**

- Climate Adaptation and Mitigation
- Weather-Ready Nation

#### **NOAA Strategic Goals:**

- Serve society's needs for weather and water
- Understand climate variability and change to enhance society's ability to plan and respond

#### **CIMSS Research Themes:**

- Education and Outreach



## Objective

Design and develop pre- and post-launch lesson plans and activities for G6-12 teachers and students for GOES-R.

## Project Overview

The GOES-R Education Proving Ground (<http://cimss.ssec.wisc.edu/education/goesr/>) features the design and development of pre- and post-launch lesson plans and activities for G6-12 teachers and students to ensure that the education community will be “launch ready” for new satellite imagery and improved products that will be available in the upcoming GOES-R era.

A key element of this effort is a core group of educators working with Education and Outreach staff at the Cooperative Institute for Meteorological Satellite Studies (CIMSS) in close coordination with NOAA scientists at the Advanced Satellite Products Branch (ASPB) and members of GOES-R Algorithm Working Group at CIMSS.

## Milestones with Summary of Accomplishments and Findings

Several new HTML5 webapps have been developed collaboratively by CIMSS and ASPB. These webapps support awareness around the new capabilities coming with GOES-R. The newest webapp, called RGB, (<http://cimss.ssec.wisc.edu/education/apps/satrgb/>) allows users to explore, via an interactive tool, how meteorologists combine satellite data from different spectral bands to create a blended colorized image that often provides more information than separate images. The app even has an option to blend spectral bands using real-time data processed at the Space Science and Engineering Center (SSEC) data center from seven different geostationary satellites. Other webapps allow exploration of temporal and spatial resolution improvements coming with GOES-R as well as the additional spectral bands (3 times) that will be available.

The biggest initiative this past year was an expansion of the GOES-R Education Proving Ground community from six educators from 3 states to 30 teachers from 13 states and Puerto Rico in advance of the October 2016 launch. These teachers are attending webinars, implementing the new webapps and previously existing lessons plans, and developing plans to promote the GOES-R launch in their schools and school districts.



Figure 98. GOES-R Educators.



Plans for a 2-day teacher workshop at Kennedy Space Center (KSC) for the October 2016 launch are also underway.

### **Publications, Reports, Presentations**

NOAA FY14 Education Accomplishments Report, page 44.

[http://www.oesd.noaa.gov/leadership/edcouncil/docs/FY15\\_NOAA\\_Education\\_Accomplishment\\_s.pdf](http://www.oesd.noaa.gov/leadership/edcouncil/docs/FY15_NOAA_Education_Accomplishment_s.pdf)

Mooney, Margaret; Schmit, Tim; Ackerman, Steve. GOES-R Education Proving Ground, EUMETSAT Meteorological Satellite Meeting. September 2015, Toulouse France.

Mooney, Margaret, Schmit, T., STEM connections to the GOES-R Satellite Series (Invited). Annual American Geophysical Union (AGU) meeting. San Francisco CA, 14-18 December 2015

Dorofy, Peter; Mooney, M. and Nazari, R. Pixel classification for pre-college students using GOES-R proxy data. Annual Symposium on New Generation Operational Environmental Satellite Systems, New Orleans, LA, 10-14 January 2016. American Meteorological Society.

Moore, John; Schmit, T. and Mooney, M. Global Weather Watchers Campaign: An Earth SySTEM project. Annual Symposium on New Generation Operational Environmental Satellite Systems, New Orleans, LA, 10-14 January 2016. American Meteorological Society.

Mooney, Margaret; Schmit, T. J.; Whittaker, T. M. and Ackerman, S. GOES-R education proving ground. Annual Symposium on New Generation Operational Environmental Satellite Systems, New Orleans, LA, 10-14 January 2016. American Meteorological Society.

Gunshor, Mathew M.; Schmit, T. J.; Schmidt, C. C.; Lindstrom, S. S.; Gerth, J. J.; Mooney, M.; Whittaker, T. M.; Goodman, S. J. and Gurka, J. J. Employing short courses to prepare for the GOES-R satellite series. Annual Symposium on New Generation Operational Environmental Satellite Systems, New Orleans, LA, 10-14 January 2016. American Meteorological Society, Boston, MA, 2016.

### **45. Project ABI Short Courses (CIMSS Support to GOES-R Program)**

**CIMSS Task Leader: Mathew M. Gunshor**

**CIMSS Support Scientists: Jordan Gerth, Scott Lindstrom, Chris Schmidt**

**NOAA Collaborator: Tim Schmit**

**Budget: \$50,000**

#### **NOAA Long Term Goals:**

- Weather-Ready Nation

#### **NOAA Strategic Goals:**

- Serve society's needs for weather and water
- Provide critical support for the NOAA mission

#### **CIMSS Research Themes:**

- Education and Outreach



## Objective

The purpose of this project is to communicate with the GOES user community on the upcoming enhancements that will be available with GOES-R.

## Project Overview

The Space Science and Engineering Center (SSEC) and the Cooperative Institute for Meteorological Satellite Studies (CIMSS) at the University of Wisconsin-Madison have a long history of training with environmental satellite data. In the past, CIMSS has developed multiple on-line tools, such as VISITView, AniS, FLANIS, and web-apps, specifically to help train users of satellite data. Most recently, this training has focused on getting users ready to understand and use data from the Advanced Baseline Imager (ABI) on GOES-R. The ABI represents a significant increase in observational capability with increased spatial, spectral, and temporal information. Users will have access to products and data from the geostationary orbit that they have not seen before. In addition there will be new products and uses that users must be made aware of.

Under this project, CIMSS anticipates has supported two short courses at American Meteorological Society meetings so far: at the 43rd Conference on Broadcast Meteorology (10-12 June 2015) and the 96th AMS Annual Meeting (9-10 January, 2016). The next meeting planned is the 44<sup>th</sup> Conference on Broadcast Meteorology (June 2016). Subsequent training events are to be determined, but may include the National Weather Association (NWA) Oct 2016 annual meeting and the January 2017 AMS Annual Meeting, both post-launch.

## Milestones with Summary of Accomplishments and Findings

CIMSS supported the GOES-R program's application to the American Meteorological Society (AMS) for a one-day short course at the 43rd Conference on Broadcast Meteorology (10-12 June 2015). Subject matter experts from CIMSS attended to present information and lead the attendees through hands-on exercise developed at CIMSS.

CIMSS leveraged material previously developed at CIMSS for the GOES-R program, prepared some new material, and merged the materials to fit the hands-on nature of a short course. Collectively the participants from CIMSS have extensive experience with training on satellite data and products, meteorology education, and development of products. These products include those that are interesting to broadcasters (severe weather, fires and other hazards).

Pre- and post-test assessments, arranged primarily by the COMET team, were given to assess the effectiveness of course material and receive feedback from the participants. The short course was well-received.

Similarly, CIMSS also supported a short course at the 96<sup>th</sup> AMS Annual Meeting in New Orleans, LA on January 9, 2016. This all day course had high attendance with nearly 50 people signing up, including Certified Consulting Meteorologists (CCMs), broadcast meteorologists, researchers, forecasters, and international partners including from Canada, Mexico, and Japan. Presentations, including links to hands-on activities are available at <http://cimss.ssec.wisc.edu/goes/shortcourse/links.html>.

Short course agenda items CIMSS either presented, prepared, or as demonstrated were:

- The GOES-R Advanced Baseline Imager (ABI) capabilities, products and concept of operations;
- Hands-on Exercise showcasing ABI's 16 channels with improved spatial resolution and temporal refresh rate;





- Hands-on Exercise, the COMET RGB Module; and
- Hands-on exercises using GOES-R derived products.



Figure 99. Dr. Marshall Shepherd delivering the lunch-time presentation at the GOES-R/JPSS AMS Short Course in New Orleans.

### **Publications and Conference Reports**

Poster “Employing Short Courses to Prepare for the GOES-R Satellite Series” at the 96th Annual AMS Meeting, New Orleans, LA, 11 January 2016. By Mathew M. Gunshor, CIMSS/Univ. of Wisconsin, Madison, WI; and T. J. Schmit, C. C. Schmidt, S. S. Lindstrom, J. J. Gerth, M. Mooney, T. M. Whittaker, S. J. Goodman, and J. J. Gurka.

### **46. Development and Delivery of Himawari Training Workshop for NWS Forecast Office in Guam**

**CIMSS Task Leader: Jordan Gerth**

**CIMSS Support Scientist: Scott Lindstrom and Kathleen Strabala**

**NOAA Collaborators: Tim Schmit, National Environmental Satellite, Data, and Information Service Advanced Satellite Products Branch, and Bill Ward, National Weather Service Pacific Region Headquarters**

**Budget: \$135,000**

### **NOAA Long Term Goals:**

- Weather-Ready Nation



### **NOAA Strategic Goals:**

- Serve society's needs for weather and water
- Provide critical support for the NOAA mission

### **CIMSS Research Themes:**

- Satellite Meteorology Research and Applications
- Education and Outreach

### **Objective**

In order to prepare meteorologists at the National Weather Service (NWS) forecast office in Guam for the capabilities of the Advanced Himawari Imager (AHI), CIMSS scientists prepared operationally oriented training, with supporting visualization software to increase learning during lab exercises, to conduct several interactive sessions.

### **Project Overview**

Three scientists from the CIMSS, Jordan Gerth, Scott Lindstrom, and Kathleen Strabala, led two two-day workshops on the AHI at the NWS forecast office in Tiyan, Guam, from 16 through 19 November 2015. Most participants were NWS meteorologists based on Guam, though two were from Micronesia (Palau and Chuuk). The NWS funded the workshops, and development of training materials related to tropical meteorology forecast challenges, as part of the Science and Technology Integration (STI) portfolio to assure "day one" readiness of NWS staff in the western Pacific Basin because the Himawari-8 launch preceded other new generation geostationary satellites.

The objectives of the training included: reaffirming understanding of core principles in radiation science, developing familiarity with the spatial, spectral, and temporal resolution of the Himawari imager, and increasing ability to select and use certain bands of satellite imagery from the Himawari imager to solve short-term weather analysis and forecast challenges. The training was specifically tailored to operational meteorologists in Guam, with examples from the tropical and subtropical Pacific.

The meteorologists at the Weather Forecast Office (WFO) in Guam were the first in the NWS to receive training on the new generation weather satellites and basic applications. The AHI is very similar to the Geostationary Operational Environmental Satellite R-Series (GOES-R) Advanced Baseline Imager. Since the operational geostationary satellite from the Japan Meteorological Agency transitioned from MTSAT-2 to Himawari-8 in early December, this timely training event ensured readiness for applying the spatial, spectral, and temporal enhancements of the AHI to forecast operations in a way that has not been done elsewhere in the United States.

### **Milestones with Summary of Accomplishments and Findings**

#### ***Workshop Logistics***

Approximately five to ten meteorologists participated in each workshop. Participants were encouraged to work together. Given that the participants were colleagues of each other, and familiar with their individual strengths and weaknesses, the environment was conducive for learning and asking questions. Among the participants, there was a diverse amount of previous knowledge on satellite meteorology. At least one participant had previously reviewed the GOES-R training materials available from COMET, but there was no prerequisite reading or other work for workshop participants.



The ratio of participants to instructors was approximately 2:1 or 3:1. This enabled instructors to quickly respond to questions and assist students in need of extra attention. It also promoted a greater degree of interaction between the instructors and participants that allowed instructors to learn about forecast challenges in the western Pacific Ocean.

### **Workshop Content**

The workshop was arranged in four four-hour segments. Each segment had a specific topic with a lecture component (approximately 30 to 60 minutes in duration), and a lab exercise component (approximately two to three hours in duration). The topics for the segments in the workshop included: introduction to the spectral bands, weighting functions and red-green-blue (RGB) composites, water vapor feature identification, and water vapor imagery for weather analysis and forecasting. Furthermore, an introduction to the workshop provided information on the operation of the Himawari-8 satellite and imager, and a capstone exercise allowed students to explore the imagery for a final time prior to finishing the workshop.

### **Special Software**

A satellite imagery visualization software application, the Satellite Imagery Familiarization Tool (SIFT), was designed for this workshop. SIFT was designed to run on consumer-grade notebook computers. Five notebook computers were procured for this workshop in order to run SIFT. Some lab exercises incorporated SIFT in order to afford the participants better looping, interrogation, and data manipulation capabilities than single or animated images provide. SIFT loads GeoTIFF files of Himawari-8 imagery. The imagery preloaded on the notebook computers that were used during the workshop came from cases that the instructors preselected.

Current capabilities of SIFT allow users to: loop through multiple bands for a single time, or multiple times for a single band; change the color enhancement by band, with transparent gradients available to visualize two bands at once; seamlessly pan and zoom across entire full disk images, even while looping; probe a point to determine the reflectance or brightness temperature for all loaded bands; and create histograms (single band) and density maps (two bands) based on a user-defined polygon on an image.

### **Publications and Conference Reports**

The Himawari training program for NWS Pacific Region meteorologists  
Talk, Asia/Oceania Meteorological Satellite Users' Conference—Capacity development and training activities (Tokyo, Japan)  
November 12, 2015

Increased Satellite Reception and Utilization Capabilities in NWS Pacific Region  
Talk, American Meteorological Society Annual Meeting—12th Symposium on New Generation Operational Environmental Satellite Systems (New Orleans, Louisiana)  
January 12, 2016

## **47. CIMSS Research Activities in the VISIT Program for 2015**

**CIMSS Task Leader: Steve Ackerman**

**CIMSS Support Scientists: Scott Lindstrom, Scott Bachmeier**

**NOAA Collaborators: Tim Schmit, Tony Mostek, Brian Motta**

### **NOAA Long Term Goals:**

- Weather-Ready Nation



### **NOAA Strategic Goals:**

- Serve society's needs for weather and water
- Provide critical support for the NOAA mission

### **CIMSS Research Themes:**

- Satellite Meteorology Research and Applications
- Education and Outreach

### **Objective**

Create training modules and provide training to NWS forecasters through the VISIT Program.

### **Project Overview**

The Virtual Institute for Satellite Integration Training (VISIT) Program is a major interaction between CIMSS and Forecast Offices of the National Weather Service. CIMSS Scientists provide training for NWS Forecasters on a variety of topics that relate to satellite topics. Increasingly this training is focused on Day 1 Readiness for the GOES-R Launch, and considerable activity in late 2015 centered on that topic.

### **Milestones with Summary of Accomplishments and Findings**

Two new training modules were created in 2015: “NOAA/CIMSS ProbSevere Product” and “NUCAPS Data in AWIPS”. In addition, the “GOES Sounder Data” Module was revised and modernized. Live VISIT Teletraining occurred on the following topics: GOES-R Fog/Low Stratus Products (training given 10 times to 10 different Weather Forecast Offices (WFOs)); Suomi-NPP Data in AWIPS (training given 2 times to 2 different WFOs); TROWAL Identification (training given 1 time to 1 office); Mesoscale Convective Vortices (training given 1 time to 1 office); NUCAPS Soundings (training given 10 times to 10 offices); Basic Satellite Principles (training given 1 time to 1 office); NOAA/CIMSS ProbSevere Product (training given 4 times to 4 offices); GOES Sounder Data (training given 1 time to 1 office). In addition, forecasters were able to take recorded Teletraining Modules at the Dept. of Commerce Learning Management System (LMS).

VISIT Satellite Chats were ~monthly wrap-ups on Satellite Topics; the chats typically centered on recent notable weather events or occurrences. The 11 monthly topics in 2015 were: “[Northeast Winter Storm and heavy snow over Amarillo](#)” (January), “[West Texas Total Lightning Mapping Array by Jason Jordan](#)” (February), “[25 March 2015 Severe Weather Event](#)” (Early April), “[16 April 2015 western trough](#)” (Mid-April), “[GOES-14 SRSOR 1-minute imagery information](#)” (May), “[Recent GOES SRSOR 1-minute imagery events](#)” (June), “[Dolores impacts in the San Diego area](#)” (July), “[GOES-14 SRSOR 1-minute imagery information](#)” (August), “[3-4 October 2015 flood event over South Carolina](#)” (October), “[African Easterly Wave Identification by satellite imagery](#)” (November) and “[Introduction to VIIRS DNB NCC imagery](#)” (December).

Data for case studies/training modules continues to be placed on CIMSS Satellite Blog (<http://cimss.ssec.wisc.edu/goes/blog>); entries include data from MODIS and Suomi NPP VIIRS that can serve as a proxy for GOES-R and JPSS. See, for example, <http://cimss.ssec.wisc.edu/goes/blog/archives/15086> for Winter Weather and <http://cimss.ssec.wisc.edu/goes/blog/archives/14795> or <http://cimss.ssec.wisc.edu/goes/blog/archives/20850> for Aviation training. Himawari-8 data (<http://cimss.ssec.wisc.edu/goes/blog/archives/category/himawari-8>) is an also excellent proxy for GOES-R and has provided useful data in preparation for GOES-R.



VISIT continues to support AWIPS capabilities that have been further refined at CIMSS. A stable AWIPS platform at CIMSS allows for manipulation of CIMSS-produced datasets, especially GOES-R Products, into formats that are compatible with AWIPS. This allows quick development of training modules using data as it appears before the forecaster in the National Weather Service Forecast Office.

### **Publications and Conference Reports**

Lindstrom, S. S. and A. S. Bachmeier, 2016: Most Popular Blog posts of 2015 from CIMSS. Oral Presentation at 25<sup>th</sup> Symposium on Education, American Meteorological Society, New Orleans, LA, 10-14 January 2016.

Lindstrom, S. S., 2015: Fog and Low Stratus Training Resources: Blogs, Videos and Facts sheets (and how they complement each other), NOAA Satellite Proving Ground/User Readiness Meeting, Kansas City, KS, 15-19 June 2015. (Invited)

Lindstrom, S. S. and A. S. Bachmeier, 2015: The Use of Blogs, Twitter and YouTube for outreach at CIMSS. Oral Presentation at 24<sup>th</sup> Symposium on Education, American Meteorological Society, Phoenix, AZ, 4-8 January 2015.



## Appendix 1: List of Awards to Staff Members

### 2016

**Jun Li:** University of Wisconsin-Madison Distinguished Scientist, a "title reserved for a small number of academic staff whose superlative accomplishments are evidenced by peer recognition."

**Michael Pavolonis,** 2015 Earth Science and Applications Award from the American Astronautical Society "for developing cutting-edge methods to convert satellite data into actionable information for mitigating hazards caused by volcanic eruptions and severe convection."

**Bill Smith,** 2016 Losey Atmospheric Sciences Award

### 2015

**Bob Aune, Brad Pierce:** STAR Recognition for 25 Years of Government Service

**Fred Best, Bob Holz, Bob Knuteson, Hank Revercomb, Bill Smith, Dave Tobin:** NASA Langley 2015 H. J. E. Reid Award

**Ankur Desai:** AMS Clarence Leroy Meisinger Award

**Ankur Desai:** AMS Award for Early Career Achievement

**Anne Sophie Daloz:** WARF Discovery Challenge Research Symposium Award

**Jessica Gartzke:** Reid Bryson Award Undergraduate Scholarship

**Jessica Gartzke:** ITSC Silver Award, Poster Presentation

**Sarah Griffin, Derrick Herndon, John Sears, Chris Velden:** NASA Group Achievement Award

**Sarah Griffin, Derrick Herndon, Tim Olander, John Sears, Dave Stettner, Chris Velden, Steve Wanzong, and Tony Wimmers:** AMS Special Award for CIMSS Tropical Cyclones website

**Allen Huang, James P Nelson III, Tom Rink, Christopher Schmidt, Anthony Schreiner, Kathleen Strabala, and the Data Center:** NOAA-CIMSS Collaboration Award: "For outstanding critical support that extended the beneficial life of an aging geostationary weather satellites, greatly improving coverage over South America"

**Jim Kossin:** Department of Commerce Bronze Medal Award: "For the development and transfer to operations of novel hurricane forecast techniques for eyewall replacement cycles"

**Mark Kulie:** NASA Group Achievement Award

**Mark Kulie:** NASA RHG Exceptional Achievement Awards for Science Teams

**Jun Li:** UW-Madison Chancellor's Award for Excellence in Research as independent investigator

**Margaret Mooney:** AMS Distinguished Educator Recognition Award for Outstanding Service to Precollege Education

**Mike Pavolonis:** AMS David Johnson Award

**Brad Pierce, Andy Heidinger, Jason Otkin, Todd Schaack:** STAR Award for Best Paper

**Jacola Roman:** ITSC Gold Award, Oral Presentation

**Tim Schmit:** Department of Commerce Gold Medal Award: For "orchestrating the use of retired geostationary weather satellites for improved coverage of South America. These unique efforts included international agreements, satellite processing research and updates, international training and satellite operations. They took what would have been retired satellites and gained an additional six total satellite years of operations from



Geostationary Operational Environmental Satellite (GOES)-10 and then GOES-12 imager and sounders for international and domestic uses”

**Christopher Rozoff:** NOAA-CIMSS Collaboration Award: “For novel hurricane forecast techniques for eyewall replacement cycles”

**Walter Sessions:** NASA Group Achievement Award for the SEAC4RS mission (Biomass Forecasting Team)

**Chris Velden:** AMS STAC Committee on Satellite Meteorology award for outstanding scientific contributions

**Pei Wang:** AMS Best Oral Presentation

**Andi Walther:** ITSC Bronze Award, Poster Presentation



## Appendix 2: Publications Summary

**Table 1** below indicates the number of reviewed and non-reviewed papers that include a CIMSS or ASPB scientist as first author during the period 2013-2015. Two additional columns show lead authorship of NOAA scientists outside of ASPB or lead authors from other institutions or organizations. When summed, peer reviewed totals for each year (in Table 1) will equal peer reviewed totals in Table 3, a longitudinal graphic.

**Table 2** below shows collaborations on papers between or among Institute, ASPB and NOAA authors outside of ASPB. Because there may be many collaborators on a given paper, the by-year totals in Table 2 will not match the actual published paper totals in Table 1 (or in Table 3); they will be greater.

A bibliography of Advanced Satellite Products Branch (ASPB) publications is available at: [http://library.ssec.wisc.edu/research\\_Resources/bibliographies/aspb](http://library.ssec.wisc.edu/research_Resources/bibliographies/aspb)

**Table 1.** Peer Reviewed and Non Peer Reviewed journal articles having CIMSS, ASPB, NOAA or Other lead authors, 2013-2015.

	Inst Lead			ASPB Lead			NOAA Lead			Other Lead		
	2013	2014	2015	2013	2014	2015	2013	2014	2015	2013	2014	2015
<b>Peer Reviewed</b>	16	21	20	4	1	4	11	4	10	34	42	50
<b>Non Peer Reviewed</b>	2	0	0	0	0	0	0	0	0	0	0	0

**Table 2.** Peer Reviewed and Non Peer Reviewed journal articles having one or more CIMSS, ASPB, or NOAA co-authors, 2013-2015.\*

	Institute Co-Author			ASPB Co-Author			NOAA Co-Author		
	2013	2014	2015*	2013	2014	2015	2013	2014	2015
<b>Peer Reviewed</b>	108	91	99	25	17	27	68	23	64
<b>Non Peer Reviewed</b>	1	0	0	2	0	0	1	0	0





**Table 3.** CIMSS Publishing History, showing peer reviewed and conference publications for the period 1995-2015.

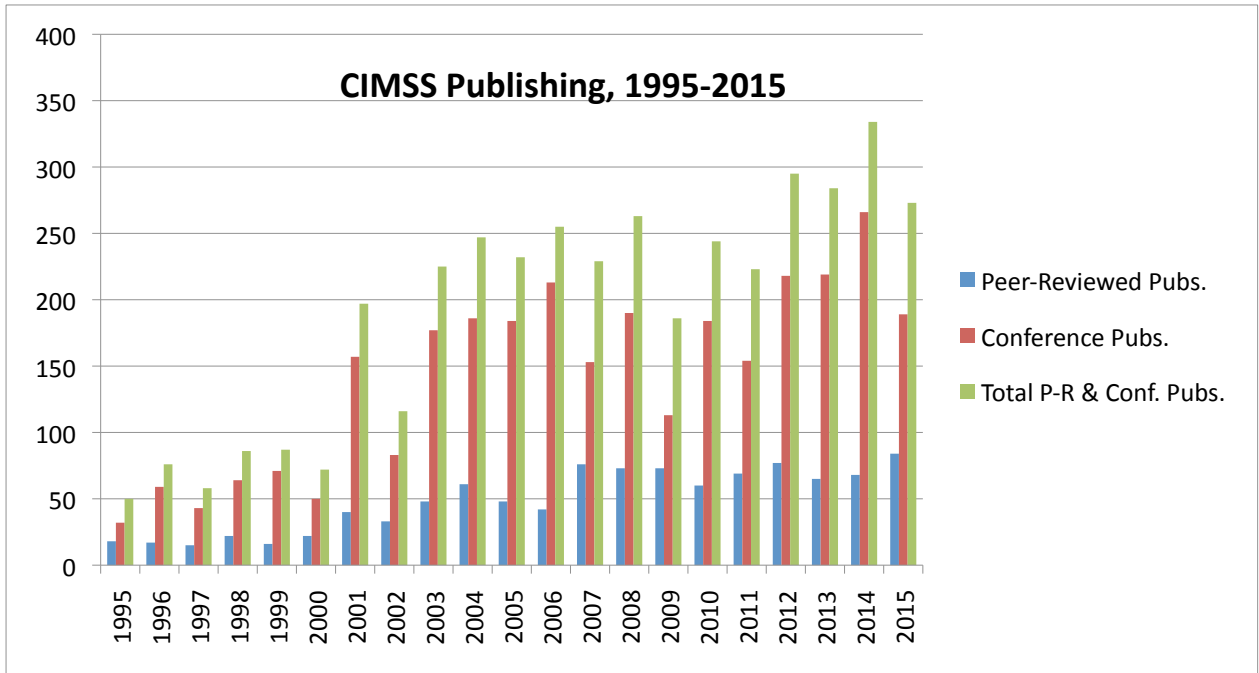



### Appendix 3: Employee Support Documentation

Personnel				
Category	Number	B.S.	M.S.	Ph.D.
Research Scientist	5	0	1	4
Visiting Scientist	0	0	0	0
Postdoctoral Fellow	1	0	0	1
Research Support Staff	24	2	14	8
Administrative	1	1	0	0
<b>Total</b> (≥ 50% Support)	31	3	15	13
Undergraduate Students	5			
Graduate Students	4			
Employees that received <50% NOAA Funding (not including students)	77	7	40	25
Located at Lab (include name of lab)	2 AWC, 1 NCWCP			
Obtained NOAA employment within the last year				



## **Appendix 4: Research Topics of Current CIMSS Graduate Students and Post-Doctors**

### **NOAA Funded Graduate Students**

#### ***Kaba Bah***

Ph.D Thesis topic: This study will focus on using nested global-to-regional air quality forecast and chemical data assimilation models, satellite, airborne and ground based in situ and remote measurements to interpret air quality in the Denver, CO region during the NSF sponsored Front Range Air Pollution and Photochemistry Experiment (FRAPPÉ) field campaign (July 2014). CIMSS, in collaboration with the LASP at the University of Colorado- Boulder will be deploying ground based remote sensing instruments during FRAPPE including the SSEC Automated High Spectral Resolution Lidar (AHSRL), Atmospheric Emitted Radiance Interferometer (AERI), and LASP Solar Spectral Flux Radiometer (SSFR) which will be used to provide continuous measurements of clouds, aerosols, ozone, carbon monoxide, and atmospheric temperature and water vapor. These measurements will be assimilated within nested RAQMS/WRF-CHEM.

#### ***Michelle Feltz***

M.S. Title: “The Use of GPS Radio Occultation and Hyperspectral Infrared Sounder Data in Stratospheric Temperature Monitoring.” This research explores the utility of the combination of GPS radio occultation (RO) and hyperspectral infrared sounder data. A sounder and RO profile-to-profile matchup methodology is employed for comparison of the sounder and RO temperature profiles. RO and sounder radiances are computed using a radiative transfer model from the matchup temperature dataset and are compared to the measured IR sounder radiances which can be used as a validation reference due to their low measurement uncertainty. This work focuses on the stratospheric region and is motivated in part by the need for instruments that can provide climate quality datasets.

#### ***Amanda Gumber***

The research is focused on studying the 3D radiative effects of clouds using MODIS satellite data. Using a timeseries of global MODIS data from both Aqua and Terra, areas will be identified as being susceptible to the influence of internal and external cloud inhomogeneity based on using a spatial heterogeneity index based on the 0.65  $\mu\text{m}$  reflectance, solar zenith angle, and viewing zenith angle. After identifying these regions, perform 3D radiative transfer calculations using a Monte Carlo model and compare the results against plane-parallel calculations for the Independent Column Approximation(ICA) and non-ICA. From this, estimate the magnitude of retrieval bias of the optical properties and the horizontal movement of photons. With those results, identify the magnitude of the visible reflectance measurements that can be attributed to the internal and external inhomogeneity of clouds. Another part of the research is helping produce a MODIS maritime water cloud record which will account for the influence of external and internal cloud inhomogeneity and calculated statistics of in-cloud distributions of cloud properties that conserve solar reflectance.

#### ***Kyle Hosley***

Research focuses on examining the trajectories of high aerosol optical depth (AOD) signals, as seen by the MODIS satellite, using the Infusing satellite Data into Environmental Applications - International (IDEA-I) software. So far, the Rim Fire from August of 2013 has been analyzed using the forecast trajectories to determine the sphere of influence of trajectories from each day



and to determine the cumulative influence on each day from trajectories initiated up to 2 days prior. Future research will include looking at other fires to determine their sphere of influence and looking at similar trajectories for ozone to diagnose stratospheric intrusion events.

***Xiaowei Jiang***

M.S. Title: "Evaluation of environmental moisture from NWP models with measurements from advanced geostationary satellite imager." The atmospheric moisture in the environment is associated with storm development, and it is important to evaluate the uncertainty of moisture fields in the environment from numerical weather prediction (NWP) models for better understanding the associate of the environmental moisture with storm prediction. This study develop a new methodology on evaluate moisture in environment from NWP models and associated with tropical cyclone forecast. This methodology can be applied to improve the TC forecasts.

***Aaron Letterly***

Research focuses on using AVHRR sea ice concentrations and ERA-Interim reanalysis output to assess factors contributing to winter sea ice growth. Particularly interested in creating a climatology of winter cloud anomaly and determining its lagged correlation with fluctuations in sea ice area anomaly. The absence of arctic sunlight throughout the winter months doesn't "turn off" the melting of sea ice, but rather sets the stage for longwave re-emission by clouds to dominate the surface energy budget in marginal ice areas (i.e., the Beaufort Sea). Comparing the 32 years of AVHRR-sensed sea ice concentration records in conjunction with anomalously clear or cloudy years allows the determination of just when winter clouds were a major contributor to changes in the sea ice record. Through extensive analysis, would like to determine seasonal cloud amount's role as a predictor on future sea ice area anomaly.

***Yue Li***

Post Doc Research: We studied the diurnal variations of land surface emissivities (LSE) using geostationary satellite data observations. Better understanding of LSE change can improve the retrieval accuracy from satellite observations and reduce uncertainties in number weather predictions. So the aim of this study is to investigate the magnitude and factors resulting variations of the LSE change.

b. We assessed the quality of CrIMSS post-launch EDR product. This assessment is important to report possible biases and deficiencies prior to the official release of CrIMSS product.

***Jacola Roman (Graduated, started on Ph.D.)***

M.S. Thesis title: "Climatological Analysis and Assessment in Global Climate Models and Observations of Precipitable Water Vapor (PWV) and Sea Surface Temperature (SST)". This study examines regional monthly mean and seasonal trends in PWV using ground-based GPS measurements as well as satellite (AIRS and AMSR-E) observations and reanalysis (NARR). Additionally, the study examines the simulations of the GCMs of SST for two different scenarios (decadal run 1980 and decadal run 2000). A comparison to observations will be done, in an attempt to show which scenario best stimulates the observations from 2000-2010. Once a scenario is distinguished, the assessment of GCMs at simulating the PWV observations will be examined and evaluated, similar to the analysis done on the observations.

***Gary Wade***

Extending work of Ralph Petersen and Richard J. Dworak (CIMSS), research analyzes the accuracy of the moisture gradients in the GOES (Geostationary Operational Environmental Satellite) Sounder retrieved moisture fields, primarily employing comparison with independent, remotely sensed GPS (Global Positioning System) moisture data. With spatial and temporal



scales comparable with GOES, GPS affords a measure of comparison that can be examined for gradients. Although retrieved moisture data from the GOES Sounder, with its limited spectral resolution, have traditionally had small impact and have been underutilized, gradient information avoids the issue of simple biases in the data. As low spectral resolution moisture data from geostationary orbit will continue in the near future with GOES-R, this study remains relevant in attempting to exploit the current and future GOES moisture measurements. As forecasters currently examine and assess the CIMSS GOES Nearcast system, where in one approach GOES layered moisture fields are advected ahead to estimate atmospheric stability, this study may help legitimize how unique and accurate one might consider the Nearcast products.

### ***Pei Wang***

Ph.D. research focuses on the assimilation of the Cross-track Infrared Sounder (CrIS) data and its impact on hurricane forecast in regional NWP model. CrIS is onboard the Suomi National Polar-Orbiting Operational Environmental Satellite System Preparatory Project satellite (S-NPP) and the Joint Polar Satellite System (JPSS). To reduce the cloud contamination for CrIS assimilation, the collocated high resolution cloud mask from the Visible Infrared Imaging Radiometer Suite (VIIRS) is used to help CrIS cloud detection. The cloud contamination is reduced with the collocated VIIRS cloud mask, which improves the analysis fields and the track forecast of Hurricane Joaquin (2015). The cloud-clearing method is to get the equivalent clear radiances under partially cloudy regions. The assimilation of cloud-cleared radiances is an alternative way to assimilate the thermodynamic and hydrometric information under partially cloudy regions. The assimilation of cloud-cleared CrIS radiances data need to be further studied in the future.

### ***Feng Zhu***

Ph.D. research topic is high temporal resolution geostationary satellite data assimilation for tropical storms, aiming at better utilizing the satellite observations to improve the forecast of tropical storms. One part of my research is evaluating and quantifying the impact of potential high temporal resolution geostationary satellite data sets on tropical cyclone (TC) forecasting with the method of observation system simulation experiments (OSSE). I am also working on developing a new method of tropical cyclone relocation to improve the initialization of TC and, meanwhile, to evaluate the impact of relocation on satellite data assimilation. Besides, I have an independent research topic, that is, regarding the atmospheric system as a dynamical system, investigating the relationship between initial error, model error, and forecast error from both theoretical and practical sides. Conducting ideal experiments with toy models such as Lorenz63 and Lorenz96, and realistic experiments with WRF/GSI system, with the method of data assimilation and OSSE.

## **Students Funded on other projects than NOAA**

### ***David Loveless***

M.S. Title: “Composite Bore Analysis Using Ground-based Remote Sensing Instruments during the PECAN Campaign.” Atmospheric bores are a type of gravity wave that commonly form as a result of the interaction between a stable layer and thunderstorm outflow. Bores propagate ahead of the thunderstorm outflow, along the interface between the stable surface layer and the free troposphere. Atmospheric bores were a focal point of the Plains Elevated Convection at Night (PECAN) field campaign, which took place during the summer of 2015. Atmospheric Emitted Radiance Interferometers (AERI) and Doppler wind lidars were deployed at both fixed locations and with two mobile units during PECAN, forming an integrated sounding array. Combined, these instruments observe thermodynamic and kinematic profiles within the boundary layer.



These instruments will be used to construct a composite analysis of atmospheric bore passages. This work is conducted with the goal of better characterizing bore ducting layers, and understanding the boundary layer evolution during bore passages. By understanding boundary layer evolution during bore passages, the potential role of atmospheric bores in nocturnal convective initiation can be described.

***Brent Maddux***

Ph.D. Thesis title: "Analyses of the MODIS Global to Regional Cloud Properties and Uncertainty." This study analyzes the MODIS global and regional cloud property data records. Cloud property histograms and statistics are utilized to characterize the global cloud property fields and attribute systematic errors and biases to their source. In conjunction with the GEWEX Cloud Climatology Comparison working group, this effort will help characterize the MODIS data records for future improvement and potential merger with other satellite data records.

***Marian Mateling***

M.S. title: "Spaceborne Snowfall Retrievals: Information gained from Day 1 GPM GPROF Empirical Databases" This research compares multiple independent global snowfall datasets (e.g., CloudSat, ERA-Interim, GPM) to identify global snowfall characteristics based on environmental and cloud microphysical properties, illustrate regional biases - and possible causes for these biases - within the independent snowfall datasets, and highlight certain regions or snowfall modes that may be challenging for the Global Precipitation Measurement (GPM) Goddard Profiling (GPROF) precipitation retrieval algorithm due to inherent GPM observational limitations. Results from this research will be used to quantify global snowfall and improve multi-sensor spaceborne snowfall retrievals.

***Jacob Miller***

M.S. Research topic: This research is looking at the temporal and spatial extent of Arctic Leads, located north of Alaska. This is done by using MODIS retrieved data in an algorithm to detect the cloud cover, and find open "windows" with no clouds. In these windows another algorithm determines the coverage of ice and the orientation and width of leads based off a 95% threshold, which is then mapped, and later to be projected back on to a common grid. Currently the research involves case studies covering the time from Feb-April on selected years, in order to further improve/test the algorithms and research hypothesis.

***Kyle Nelson***

M.S. Thesis title: "Optically Thin Liquid Clouds: Detection and Assessment of Contribution to Greenland Melt Events Using Satellite Data." Clouds play a fundamental role in the mass budget of the world's major ice sheets both as a source, via precipitation, and as a sink, via surface melt due to radiative forcing. To understand present and future effects of changes to the world's ice sheets requires a robust understanding of the macro and microphysical properties of polar cloud systems, including their radiative effects on the surface. For this study, the TERRA Moderate Resolution Imaging Spectroradiometer (TERRA-MODIS) is used to diagnose the spatial extent and frequency of occurrence of optically thin, liquid clouds over the Greenland Ice Sheet (GIS). Results from the Integrated Characterization of Energy, Clouds, Atmospheric State and Precipitation at Summit (ICECAPS) campaign noted a historically rare period of extended surface melting observed across the entire Greenland ice sheet in July 2012. A study by Bennartz et al. (2013), using ICECAPS surface instrument data and simple radiative transfer modeling, determined that low-level liquid clouds played a key role in that melt event by helping to increase surface temperatures above freezing. Preliminary results show similar geographic coverage of thin, liquid clouds in July 2011 and July 2012. A qualitative analysis of low-level



warm air advection for both years will be combined with satellite data and radiative transfer modeling to determine why melting occurred over such a large area in July 2012 as compared to July 2011.

### ***Alexa Ross***

Research involves understanding the relationship between cloud ice orientation and precipitation over maritime regions. By examining CloudSat reflectivities and CALIOP depolarization ratios side by side, I hope to confirm whether or not signatures of horizontally oriented ice crystals in low clouds increase the chances of precipitation. The experiment will also look into whether or not there are seasonal and/or geographic dependencies on the correlation of ice orientation and precipitation.

### ***Walter Sessions***

M.S. Thesis title: "Exploitation of Hyperspectral Infrared Radiance and Retrieval Product data to improve Numerical Dust Modeling through Ensemble Kalman Filter Assimilation Techniques". Aerosols represent a poorly constrained yet highly influential atmospheric component. With highly discretized sources and sinks, aerosols require as many observation channels as possible. Despite this, many of the current generation of satellite assimilation products rely on the visible spectrum limiting observations to half orbits. We are looking to infrared bands to remove this constraint. The multispectral sensors often used for aerosol retrievals have had limited success with this task. We are first building a database of the spectral signatures of mineral dust in the infrared and using the higher spectral resolution found in hyperspectral sounders (space, aircraft, and ground based), to try and produce an assimilation grade product. Verification and validation will be done through the Naval Research Laboratory's Ensemble Kalman Filter Assimilation System to evaluate efficacy.

### ***Skylar Williams***

This research focuses on support for improving the use of airborne observations in daily forecasting within NOAA NWS. Commercial aircraft measurements from the AMDAR dataset include pressure, temperature, and relative humidity allow for a vertical profile of the atmosphere to be created when aircraft takeoff and land. While the Water Vapor Sensing System II (WVSS-II) sensor has been validated against rawinsonde launches during short-term localized validation experiments, this research promises a CONUS-wide comparison of this sensor to balloon-based observations that can account for different seasons and climates. This will allow for a basis to find when aircraft profiles can be used as an alternative to rawinsonde launches.

### ***Keiko Yamamoto***

M.S. Title: "Dust Detection Using IR Channels of Himawari-8" The main focus of this research is to detect dust over land and ocean all day. The previous research showed that it is possible to detect dust using 8  $\mu\text{m}$ , 11  $\mu\text{m}$  and 12  $\mu\text{m}$  channels over land; however, these channels alone cannot detect dust over ocean. If visible or near infra-red channels are used, it can detect dust quite well over land and ocean during daytime but the accuracy drops drastically during nighttime. In this study, 8.6  $\mu\text{m}$ , 10.4  $\mu\text{m}$ , 11.2  $\mu\text{m}$ , and 12.4  $\mu\text{m}$  channels on Himawari-8 are used, and a new algorithm for dust detection was developed. There are still noise especially during nighttime; however, the new algorithm improved the accuracy of dust detection over land and ocean, and during both daytime and nighttime.



## Appendix 5: Visitors at CIMSS 2015-2016 (visits of 3 days or more and key visitors)

Yufei <b>Ai</b>	Peking University
Jay <b>Cable</b>	Geographic Information Network of Alaska (GINA), University of Alaska
Yi-Chun <b>Chen</b>	JPL/CalTech
Dehui <b>Cheng</b>	Chief Engineer, China Meteorological Administration (CMA) Numerical Weather Prediction Center (NWPC)
Carl <b>Dierking</b>	Geographic Information Network of Alaska (GINA), University of Alaska
Laura <b>Dobor</b>	Eotvos Lorand University, Department of Meteorology, Hungary
Iliana <b>Genkova</b>	I. M. Systems Group
Jiandong <b>Gong</b>	Deputy Director, China Meteorological Administration (CMA) Numerical Weather Prediction Center (NWPC)
Xinya <b>Gong</b>	Institute of Atmospheric Physics, Chinese Academy of Sciences
Kelton <b>Halbert</b>	Oklahoma University
Wei <b>Han</b> CMA/NWPC	Deputy Director, Division of Modeling and Data Assimilation,
Hyo-Jin <b>Han</b>	Seoul National University
Burcu <b>Kabatas</b>	Istanbul Technical University
Mike <b>Kalb</b>	Acting Director, NOAA/NESDIS/STAR
Satya <b>Kalluri</b>	Chief, NOAA/NESDIS/STAR Cooperative Research Program Division
Hye-Sil <b>Kim</b>	Ewha Women's University (Korea)
Bo-Ram <b>Kim</b>	Ewha Women's University (Korea)
Alexander <b>Koltunov</b>	CSTARS, University of California-Davis
Paul <b>Kucera</b>	National Center for Atmospheric Research (NCAR)
Juan <b>Li</b>	China Meteorological Administration (CMA) Numerical Weather Prediction Center (NWPC)
Wen <b>Liu</b>	Xi'an Institute of Optics and Precision Mechanics, Chinese Academy of Sciences
Johannes <b>Nielsen</b>	Danish Meteorological Institute
Aku <b>Riihela</b>	Finnish Meteorological Institute
Kirsti <b>Salonen</b>	European Center for Medium-range Weather Forecasting (ECMWF)
Yasuhiko <b>Sumida</b>	Meteorological Satellite Center of the Japan Meteorological Agency (JMA)





<b>David Turner</b>	NOAA National Severe Storms Laboratory
<b>Susan Ustin</b>	Director, CSTARS, University of California-Davis
<b>Lu Wang</b>	Chengdu University of Technology
<b>Tao Yu</b>	Xi'an Institute of Optics and Precision Mechanics, Chinese Academy of Sciences
<b>Hua Zhang</b>	Senior Scientist, China Meteorological Administration (CMA) Numerical Weather Prediction Center (NWPC)
<b>Cong Zhou</b>	East China Normal University
<b>Lin Zhu</b>	National Satellite Meteorological Center of China Meteorological Administration



## **Appendix 6: List of Staff/Students hired by NOAA in the past years**

**None.**



## Appendix 7: CIMSS Board of Directors and Science Council

### CIMSS Board of Directors

The Board of Directors meets formally approximately once a year to review the policies, research themes, and priorities of CIMSS, including budget and scientific activities. The Board is also responsible for approving the appointment of members to the Science Advisory Council. The most recent Board of Directors meeting was held in July 2014. Current Board of Directors members include:

Marsha Mailick	Associate Vice Chancellor for Research and Graduate Education, UW–Madison
Steven A. Ackerman	Director, CIMSS, UW–Madison
Henry E. Revercomb	Director, SSEC, UW–Madison
Grant Petty	Chair, Department of Atmospheric and Oceanic Sciences, UW–Madison
Steven Volz	Assistant Administrator for Satellite and Information Services, NOAA/NESDIS
Alfred Powell	Director, Center for Satellite Applications and Research, NOAA/NESDIS
Jeff Key	Chief, Advanced Satellite Products Branch, NOAA/NESDIS
Jack A. Kaye	Associate Director for Research, NASA
Peter Hildebrand	Director, Earth-Sun Exploration Division of the Sciences and Exploration Directorate, NASA Goddard Space Flight Center
David F. Young	Director, Science Directorate, NASA Langley Research Center

### CIMSS Science Advisory Council

The Science Advisory Council advising the CIMSS Director in establishing the broad scientific content of CIMSS programs, promoting cooperation among CIMSS, NOAA, and NASA, maintaining high scientific and professional standards, and preparing reports of CIMSS activities. The Science Council normally meets every 1-2 years; however, the last Council meeting was held in November 2009. Science Council members include:

Allen Huang	Distinguished Scientist, CIMSS, UW–Madison
Chris Velden	Senior Scientist, CIMSS, UW–Madison
Trina McMahon	Professor, College of Engineering, UW–Madison
Annemarie Schneider	Professor, SAGE, UW–Madison
Ralf Bennartz	Professor, Vanderbilt University
Chris Kummerow	Professor, Department of Atmospheric Science, Colorado State University
Steve Goodman	GOES-R Program Scientist, NOAA/NESDIS/ORA
Christopher Brown	Chief, Atmospheric Research and Applications Division, NOAA/NESDIS/ORA
Steve Platnick	Aqua Deputy Project Scientist, EOS Senior Project Scientist (acting), NASA Goddard Space Flight Center
Pat Minnis	Senior Research Scientist, NASA Langley Research Center



## Appendix 8: CIMSS Publications, 2013-2016

### CIMSS Peer-Reviewed Publications, 2013-16

#### 2016: In Press, Accepted, or In Review

Boukabara, S., Zhu, T., Hendrik, T., Lord, S., Goodman, S., Atlas, R., Goldberg, M., Auligne, T., Pierce, B., et al. S4: An O2R/R2O infrastructure for optimizing satellite data utilization in NOAA numerical modeling systems: A step toward bridging the gap between research and operations. *Bulletin of the American Meteorological Society*, accepted for publication.

Heymsfield, A., Matrosov, S., and Wood, N. toward improving ice water content and snow rate retrievals from radars, Part I: X and W bands, emphasizing CloudSat. *Journal of Applied Meteorology and Climatology*, in press.

Hioki, S., P. Yang, B. A. Baum, S. E. Platnick, K. G. Meyer, M. D. King, and J. Riedi, 2015: Inference of the ice cloud particle roughness parameter in polarimetric data. *Atmospheric Chemistry and Physics Discussion*, in revision.

Kossin, J. P., K. A. Emanuel, and S. J. Camargo, 2016: Past and projected changes in western North Pacific tropical cyclone exposure. *Journal of Climate*, in review.

Kossin, J. P., K. A. Emanuel, and G. A. Vecchi, 2016: Comment on 'Roles of interbasin frequency changes in the poleward shifts of the maximum intensity location of tropical cyclones'. *Environmental Research Letters*, in press.

Kulie, M. S., L. Milani, N. Wood, S. Tushaus, and T. L'Ecuyer. A shallow cumuliform snowfall census using spaceborne radar. *Journal of Hydrometeorology*, in Press.

Menzel, W. P., R. A. Frey, E. E. Borbas, B. A. Baum, G. Cureton, and N. Bearson. Reanalysis of HIRS satellite measurements from 1980-2015: Development of a consistent decadal cloud record. *Journal of Applied Meteorology and Climatology*, in review.

Miller, D. J., Zhang, Z., Ackerman, S., Platnick, S., and Baum, B.A. The impact of cloud vertical structure on cloud liquid water path retrieval based on the bi-spectral method: A theoretical study based on large-eddy simulations of shallow marine boundary-layer clouds. *Journal of Geophysical Research*, in press.

Orf, L., Wilhelmson, R., and Wicker, L. Visualization of a simulated long-track EF5 tornado embedded within a supercell thunderstorm. *Parallel Computing*, in press.

Palermé, C., Genthon, C., Claud, C., Kay, J.E., Wood, N.B., and L'Ecuyer, T. Evaluation of current and projected Antarctic precipitation in CMIP5 models. *Climate Dynamics*, in press.

Petersen, R.A. On the impact and future benefits of AMDAR observations in operational forecasts. Part 1: A review of the impact of automated aircraft wind and temperature reports. *Bulletin of the American Meteorological Society*, accepted for publication.

Petersen, R.A., Cronicé, R., Mamrosh, R., Baker, R., and Pauley, P. On the impact and future benefits of AMDAR observations in operational forecasting. Part 2: Water vapor observations. *Bulletin of the American Meteorological Society*, accepted for publication.

Rink, T., Menzel, W.P., Gumley, L., and Strabala, K. HYDRA2 – A multispectral data analysis toolkit for sensors on Suomi NPP and other current satellite platforms. *Bulletin of the American Meteorological*



Society, accepted for publication.

Wang, X., Key, J., Kwok, R., Zhang, J. Comparison of Sea Ice Thickness from Satellites, Aircraft, and PIOMAS Data. *Remote Sensing*, submitted.

**2016**

Anderson, M.C., Zolin, C.A., Sentelhas, P.C., Hain, C.R., Semmens, K., Yilmaz, M.T., Gao, F., Otkin, J.A., and Tetrault, R., 2016. The Evaporative Stress Index as an indicator of agricultural drought in Brazil: An assessment based on crop yield impacts. *Remote Sensing of Environment*, 174(1): 82-99.

Brunner, J., Pierce, R.B., and Lenzen, A., 2016. Development and validation of satellite-based estimates of surface visibility. *Atmospheric Measurement Techniques*, 9(2): 409-422.

Gravelle, C.M., Mecikalski, J.R., Line, W.E., Bedka, K.M., Petersen, R.A., Sieglaff, J.M., Stano, G.T., and Goodman, S.J., 2016. Demonstration of a GOES-R satellite convective toolkit to "bridge the gap" between severe weather watches and warnings: An example from the 20 May 2013 Moore, Oklahoma, tornado outbreak. *Bulletin of the American Meteorological Society*, 97(1): 69-84.

Greenwald, T.J., Pierce, R.B., Schaack, T., Otkin, J., Rogal, M., Bah, K., Lenzen, A., Nelson, J., Li, J., and Huang, H.-L., 2016. Real-time simulation of the GOES-R ABI for user readiness and product evaluation. *Bulletin of the American Meteorological Society*, 97(2): 245-261.

Griffin, S.M., Bedka, K.M., and Velden, C.S., 2016. A method for calculating the height of overshooting convective cloud tops using satellite-based IR imager and CloudSat cloud profiling radar observations. *Journal of Applied Meteorology and Climatology*, 55(2): 479-491.

Key, J., Wang, X., Liu, Y., Dworak, R., and Letterly, A., 2016. The AVHRR Polar Pathfinder climate data records. *Remote Sensing*, 8(3): doi:10.3390/rs8030167 .

Kossin, J.P. and DeMaria, M., 2016. Reducing operational hurricane intensity forecast errors during eyewall replacement cycles. *Weather and Forecasting*, 31(2): 601-608.

Kulie, M.S., Milani, L., Wood, N.B., Tushaus, S.A., Bennartz, R., and L'Ecuyer, T., 2016. A shallow cumuliform snowfall census using spaceborne radar. *Journal of Hydrometeorology*, 17(4): 1261-1279.

Letterly, A., Key, J., and Liu, Y., 2016. The influence of winter cloud on summer sea ice in the Arctic, 1983-2013. *Journal of Geophysical Research-Atmospheres*, 121(5): 2178-2187.

Liu, C.-Y., Li, J., Ho, S.-P., Liu, G.-R., Lin, T.-H., and Young, C.-C., 2016. Retrieval of atmospheric thermodynamic state from synergistic use of radio occultation and hyperspectral infrared radiances. *IEEE Journal of Selected Topics in Applied Earth Observations and Remote Sensing*, 9(2): 744-756.

Mielikainen, J., Huang, B., and Huang, H.-L.A., 2016. Optimizing Purdue-Lin microphysics scheme for Intel Xeon Phi coprocessor. *IEEE Journal of Selected Topics in Applied Earth Observations and Remote Sensing*, 9(1): 425-438.

Mielikainen, J., Price, E., Huang, B., Huang, H.-L.A., and Lee, T., 2016. GPU Compute Unified Device Architecture (CUDA)-based parallelization of the RRTMG shortwave rapid radiative transfer model. *IEEE Journal of Selected Topics in Applied Earth Observations and Remote Sensing*, 9(2): 921-931.

Otkin, J.A., Anderson, M.C., Hain, C., Svoboda, M., Johnson, D., Mueller, R., Tadesse, T., Wardlow, B., and Brown, J., 2016. Assessing the evolution of soil moisture and vegetation conditions during the 2012 United States flash drought. *Agricultural and Forest Meteorology*, 218-219: 230-242.



Pettersen, C., Bennartz, R., Kulie, M.S., Merrelli, A.J., Shupe, M.D., and Turner, D.D., 2016. Microwave signatures of ice hydrometeors from ground-based observations above Summit, Greenland. *Atmospheric Chemistry and Physics*, 16(7): 4743-4756.

Plokhenko, Y., Menzel, W.P., Knuteson, R., and Revercomb, H.E., 2016. Plokhenko, Youri//Menzel, W. Paul//Knuteson, Robert//Revercomb, Henry E. *International Journal of Remote Sensing*, 37(7): 1601-1619.

Thompson, G., Tewari, M., Ikeda, K., Tessoroff, S., Weeks, C., Otkin, J., and Kong, F., 2016. Explicitly-coupled cloud physics and radiation parameterizations and subsequent evaluation of WFR high-resolution convective forecasts. *Atmospheric Research*, 168(1): 92-104.

Walsh, K.J.E., McBride, J.L., Klotzbach, P.J., Balachandran, S., Camargo, S.J., Holland, G., Knutson, T.R., Kossin, J.P., Lee, T., Sobel, A., and Sugi, M., 2016. Tropical cyclones and climate change. *Wiley Interdisciplinary Reviews-Climatic Change*, 7(1): 65-89.

Wimmers, A.J. and Velden, C.S., 2016. Advancements in objective multisatellite tropical cyclone center fixing. *Journal of Applied Meteorology and Climatology*, 55(1): 197–212.

## 2015

Azeem, I., Yue, J., Hoffmann, L., Miller, S.D., Straka, W.C.I., and Crowley, G., 2015. Multisensor profiling of a concentric gravity wave event propagating from the troposphere to the ionosphere. *Geophysical Research Letters*, 42(19): 7874-7880.

Baldassarre, G., Pozzoli, L., Schmidt, C.C., Unal, A., Kindap, T., Menzel, W.P., Whitburn, S., Coheur, P.-F., Kavgaci, A., and Kaiser, J.W., 2015. Using SEVIRI fire observations to drive smoke plumes in the CMAQ air quality model: a case study over Antalya in 2008. *Atmospheric Chemistry and Physics*, 15(14): 8539-8558.

Barnes, R.A., Brown, S.W., Lykke, K.R., Guenther, B., Butler, J.J., Schwarting, T., Turpie, K., Moyer, D., DeLuccia, F., and Moeller, C., 2015. Comparison of two methodologies for calibrating satellite instruments in the visible and near-infrared. *Applied Optics*, 54(35): 10376-10396.

Bedka, K.M., Wang, C., Rogers, R., Carey, L.D., Feltz, W., and Kanak, J., 2015. Examining deep convective cloud evolution using total lightning, WSR-88D, and GOES-14 super rapid scan datasets. *Weather and Forecasting*, 30(3): 571–590.

Campbell, J.R., Vaughan, M.A., Oo, M., Holz, R.E., Lewis, J.R., and Welton, E.J., 2015. Distinguishing cirrus cloud presence in autonomous lidar measurements. *Atmospheric Measurement Techniques*, 8(1): 435-449.

Chang, Y.-L., Wang, Y.C., Fu, Y.-S., Han, C.-C., Chansot Jocelyn, and Huang, B., 2015. Multisource data fusion and Fisher criterion-based nearest feature space approach to landslide classification. *IEEE Journal of Selected Topics in Applied Earth Observations and Remote Sensing*, 8(2): 576-588.

Cho, H.-M., Zhang, Z., Meyer, K., Lebsock, M., Platnick, S., Ackerman, A.S., Di Girolamo, L., C.-Labonnote, L., Cornet, C., Riedi, J., and Holz, R.E., 2015. Frequency and causes of failed MODIS cloud property retrievals for liquid phase clouds over global oceans. *Journal of Geophysical Research-Atmospheres*, 120(9): 4132–4154.

Cureton, G.P., 2015. Retrieval of higher order ocean spectral information from sunglint. *IEEE Transactions on Geoscience and Remote Sensing*, 53(1): 36-50.



Daloz, A.S., Camargo, S.J., Kossin, J.P., Emanuel, K., Horn, M., Jonas J. A., Kim, D., LaRow, T., Kim, Y.-K., Patricola, C.M., Roberts, M., Scoccimarro, E., Shaevitz, D., Vidale, P.L., Wang, H., Wehner, M., and Zhao, M., 2015. Cluster analysis of downscaled and explicitly simulated North Atlantic tropical cyclone tracks. *Journal of Climate*, 28(4): 1333–1361.

Daniels, T., Smith, W.L.Sr., and Kireev, S., 2015. Simulation of airborne radiometric detection of wake vortices. *IEEE Transactions on Geoscience and Remote Sensing*, 53(12): 6336-6343.

Fine, R., Miller, M.B., Burley, J., Jaffe, D.A., Pierce, R.B., Lin, M., and Gustin, M.S., 2015. Variability and sources of surface ozone at rural sites in Nevada, USA: Results from two years of the Nevada Rural Ozone Initiative. *Science of the Total Environment*, 530: 471-482.

Folmer, M.J., DeMaria, M., Ferraro, R., Beven, J., Brennan, M., Daniels, J., Kuligowski, R., Meng, H., Rudlosky, S., Zhao, L., Knaff, J., Kusselson, S., Miller, S.D., Schmit, T.J., Velden, C., and Zavodsky, B., 2015. Satellite tools to monitor and predict Hurricane Sandy (2012): Current and emerging products. *Atmospheric Research*, 166: 165-181.

Foster, M., Ackerman, S.A., Heidinger, A.K., and Maddux, B.C., 2015. State of the climate in 2014: Cloudiness. *Bulletin of the American Meteorological Society*, 96(7, supplement ): S24-S26.

Gu, L., Zhao, K., and Huang, B., 2015. Microwave unmixing with video segmentation for inferring broadleaf and needleleaf brightness temperatures and abundances from mixed forest observations. *IEEE Transactions on Geoscience and Remote Sensing*, 54(1): 279-286.

Gultepe, I., Zhou, B., Milbrandt, J., Bott, A., Li, Y., Heymsfield, A.J., Ferrier, B., Ware, R., Pavolonis, M., Kuhn, T., Gurka, J., Liu, P., and Cermak, J., 2015. A review on ice fog measurements and modeling. *Atmospheric Research*, 151: 2-19.

He, J., Zhang, Y., Glotfelty, T., He, R., Bennartz, R., Rausch, J., and Sartelet, K., 2015. Decadal simulation and comprehensive evaluation of CESM/CAM5.1 with advanced chemistry, aerosol microphysics, and aerosol-cloud interactions. *Journal of Advances in Modeling Earth Systems*, 7(1): 110–141.

Heidinger, A.K., Li, Y., Baum, B.A., Holz, R.E., Platnick, S., and Yang, P., 2015. Retrieval of cirrus cloud optical depth under day and night conditions from MODIS Collection 6 cloud property data. *Remote Sensing*, 7: 7257-7271.

Hennon, C.C., Knapp, K.R., Schreck, C.J.I., Stevens, S.E., Kossin, J.P., Thorne, P.W., Hennon, P.A., Kruk, M.C., Rennie, J., Gadea, J.-M., Striagl, M., and Carley, I., 2015. Cyclone center: Can citizen scientists improve tropical cyclone intensity records? *Bulletin of the American Meteorological Society*, 96(4): 591–607.

Herring, S.C., Hoerling, M.P., Kossin, J.P., Peterson, T.C., and Stott, P.A., 2015. Introduction to explaining extreme events of 2014 from a climate perspective. *Bulletin of the American Meteorological Society*, 96(12): S1-S4, S168-S169.

Herring, S.C., Hoerling, M.P., Kossin, J.P., Peterson, T.C., and Stott, P.A., 2015. Summary and broader context. *Bulletin of the American Meteorological Society*, 96(12): S168-S172.

Heymsfield, A.J., Bansemer, A., Poellot, M.R., and Wood, N., 2015. Observations of ice microphysics through the melting layer. *Journal of the Atmospheric Sciences*, 72(8): 2902–2928.

Hoover, B.T., 2015. Identifying a barotropic growth mechanism in East Pacific tropical cyclogenesis using adjoint-derived sensitivity gradients. *Journal of the Atmospheric Sciences*, 72(3): 1215–1234.

Huang, M., Mielkainen, J., Huang, B., Chen, H., Huang, H.-L.A., and Goldberg, M.D., 2015. Development



of efficient GPU parallelization of WRF Yonsei University planetary boundary layer scheme. *Geoscientific Model Development*, 8(9): 2977-2990.

Huang, M., Huang, B., Chang, Y.-L., Mielikeinen, J., Huang, H.-L.A., and Goldberg, M.D., 2015. Efficient parallel GPU design on WRF five-layer thermal diffusion scheme. *IEEE Journal of Selected Topics in Applied Earth Observations and Remote Sensing*, 8(5): 2249-2259.

Huang, M., Huang, B., Gu, L., Huang, H.-L.A., and Goldberg, M.D., 2015. Parallel GPU architecture framework for the WRF single moment 6-class microphysics scheme. *Computers and Geosciences*, 83: 17-26.

Huang, M., Huang, B., Li, X., Huang, H.-L.A., Goldberg, M.D., and Mehta, A., 2015. Massive parallelization of the WRF GCE model toward a GPU-based end-to-end satellite data simulator unit. *IEEE Journal of Selected Topics in Applied Earth Observations and Remote Sensing*, 8(5): 2260-2272.

Jing, Z., Li, J., Schmit, T.J., and Liu, Z., 2015. The impact of AIRS atmospheric temperature and moisture profiles on hurricane forecasts: Ike (2008) and Irene (2011). *Advances in Atmospheric Sciences*, 32(3): 319-335.

Kabatas, B., Unal, A., Pierce, R.B., Kindap, T., and Pozzoli, L., 2015. The contribution of Saharan dust in PM10 concentration levels in Anatolian Peninsula of Turkey. *Science of the Total Environment*, 488-489: 413-421.

Kaplan, J., Rozoff, C.M., DeMaria, M., Sampson, C.R., Kossin, J.P., Velden, C.S., Cione, J.J., Dunion, J.P., Knaff, J.A., Zhang, J.A., Dostalek, J.F., Hawkins, J.D., Lee, T.F., and Solbrig, J.E., 2015. Evaluating environmental impacts on tropical cyclone rapid intensification predictability utilizing statistical models. *Weather and Forecasting*, 30(5): 1374-1396.

Kossin, J.P., 2015. Hurricane wind-pressure relationship and eyewall replacement cycles. *Weather and Forecasting*, 30(1): 177-181.

Kossin, J.P., 2015. Validating atmospheric reanalysis data using tropical cyclones as thermometers. *Bulletin of the American Meteorological Society*, 96(7): 1089-1096.

Kossin, J.P., Karl, T.R., Knutson, T.R., Emanuel, K.A., Kunkel, K.E., and O'Brien, J.J., 2015. Reply to "Comments on 'Monitoring and understanding trends in extreme storms: State of Knowledge'". *Bulletin of the American Meteorological Society*, 96(7): 1177-1179.

Kruk, M.C., Schreck, C.J., and Griffin, K.S., 2015. State of the climate in 2014: Remnant Eastern Pacific storms drive wacky weather across the US. *Bulletin of the American Meteorological Society*, 96(7, supplement): S108-S109.

Kummerow, C.D., Randel, D.L., Kulie, M., Wang, N.-Y., Ferraro, R., Munchak, S.J., and Petkovic, V., 2015. The evolution of the Goddard Profiling Algorithm to a fully parametric scheme. *Journal of Atmospheric and Oceanic Technology*, 32(12): 2265-2280.

Langford, A.O., Pierce, R.B., and Schultz, P.J., 2015. Stratospheric intrusions, the Santa Ana winds, and wildland fires in Southern California. *Geophysical Research Letters*, 42(14): 6091-6097.

Langford, A.O., Senff, C.J., Alvarez III, R.J., Brioude, J., Cooper, O.R., Holloway, J.S., Lin, M.Y., Marchbanks, R.D., Pierce, R.B., Sandberg, S.P., Weickmann, A.M., and Williams, E.J., 2015. An overview of the 2013 Las Vegas Ozone Study (LVOS): Impact of stratospheric intrusion and long-range transport on surface air quality. *Atmospheric Environment*, 109: 305-322.

Lattanzio, A., Fell, F., Bennartz, R., Trigo, I.F., and Schulz, J., 2015. Quality assessment and improvement





of the EUMETSAT Meteosat Surface Albedo Climate Data Record. *Atmospheric Measurement Techniques*, 8(10): 4561-4571.

Lee, Y.-K., Kongoli, C., and Key, J., 2015. An in-depth evaluation of heritage algorithms for snow cover and snow depth using AMSR-E and AMSR2 measurements. *Journal of Atmospheric and Oceanic Technology*, 32(12): 2319–2336.

Levy, R.C., Munchak, L.A., Mattoo, S., Patadia, F., Remer, L.A., and Holz, R.E., 2015. Towards a long-term global aerosol optical depth record: Applying a consistent aerosol retrieval algorithm to MODIS and VIIRS-observed reflectance. *Atmospheric Measurement Techniques*, 8(10): 4083-4110.

Li, X., Huang, B., and Zhao, K., 2015. Massively parallel GPU design of automatic target generation process in hyperspectral imagery. *IEEE Journal of Selected Topics in Applied Earth Observations and Remote Sensing*, 8(6): 2862-2869.

Liu, Y.-A., Huang, H.-L.A., Gao, W., Lim, A.H.N., Liu, C., and Shi, R., 2015. Tuning of background error statistics through sensitivity experiments and its impact on typhoon forecast. *Journal of Applied Remote Sensing*, 9(1): doi:10.1117/1.JRS.9.096051.

Liu, Y., 2015. Estimating errors in cloud amount and cloud optical thickness due to limited spatial sampling using a satellite imager as a proxy for nadir-view sensors. *Journal of Geophysical Research-Atmospheres*, 120(14): 6980-6991.

Lui, Y., Key, J., Tschudi, M., Dworak, R., Mahoney, R., and Baldwin, D., 2015. Validation of the Suomi NPP VIIRS ice surface temperature environmental data record. *Remote Sensing*, 7(12): 17258-17271.

Ma, Y., Wu, H., Wang, L., Huang, B., Ranjan, R., Zomaya, A., and Jie Wei, 2015. Remote sensing big data computing: Challenges and opportunities. *Future Generation Computer Systems*, 51: 47-60.

Manion, A., Evans, C., Olander, T.L., Velden, C.S., and Grasso, L.D., 2015. An evaluation of advanced Dvorak Technique-derived tropical cyclone intensity estimates during extratropical transition using synthetic satellite imagery. *Weather and Forecasting*, 30(4): 984–1009.

Merrelli, A., Bennartz, R., O'Dell, C.W., and Taylor, T.E., 2015. Estimating bias in the OCO-2 retrieval algorithm caused by 3-D radiation scattering from unresolved boundary layer clouds. *Atmospheric Measurement Techniques*, 8(4): 1641-1656.

Mielikainen, J., Huang, B., and Huang, H.-L.A., 2015. Optimizing Total Energy-Mass Flux (TEMF) planetary boundary layer scheme for Intel's Many Integrated Core (MIC) architecture. *IEEE Journal of Selected Topics in Applied Earth Observations and Remote Sensing*, 8(8): 4196-4119.

Mielikainen, J., Huang, B., Huang, H.-L.A., and Lee, T., 2015. Performance and scalability of the JCSDA Community Radiative Transfer Model (CRTM) on NVIDIA GPUs. *IEEE Journal of Selected Topics in Applied Earth Observations and Remote Sensing*, 8(4): 1519-1527.

Miller, S.D., Straka, W.C.I., Yue, J., Smith, S.M., Alexander, M.J., Hoffmann, L., Setvak, M., and Partain, P.T., 2015. Upper atmospheric gravity wave details revealed in nightglow satellite imagery. *Proceedings of the National Academy of Sciences (PNAS)*, 112(49): E6728–E6735.

Norin, L., Devasthale, A., L'Ecuyer, T.S., Wood, N.B., and Smalley, M., 2015. Intercomparison of snowfall estimates derived from the CloudSat Cloud Profiling Radar and the ground-based weather radar network over Sweden. *Atmospheric Measurement Techniques*, 8(12): 5009-5021.

Otkin, J.A., Anderson, M.C., Hain, C., and Svoboda, m., 2015. Using Temporal Changes in Drought Indices to Generate Probabilistic Drought Intensification Forecasts. *Journal of Hydrometeorology*, 16(1):



88–105.

Otkin, J.A., Shafer, M., Svobada, M., Wardlow, B., Anderson, M.C., Hain, C., and Basara, J., 2015. Facilitating the use of drought early warning information through interactions with agricultural stakeholders. *Bulletin of the American Meteorological Society*, 96(7): 1073–1078.

Pavlonis, M.J., Sieglaff, J., and Cintineo, J., 2015. Spectrally Enhanced Cloud Objects - A generalized framework for automated detection of volcanic ash and dust clouds using passive satellite measurements: 2. Cloud object analysis and global application. *Journal of Geophysical Research-Atmospheres*, 120(15): 7842-7870.

Pavlonis, M.J., Sieglaff, J., and Cintineo, J., 2015. Spectrally Enhanced Cloud Objects - A generalized framework for automated detection of volcanic ash and dust clouds using passive satellite measurements: 1. Multispectral analysis. *Journal of Geophysical Research-Atmospheres*, 120(15): 7813-7841.

Posselt, D.J., Li, X., Tushaus, S.A., and Mecikalski, J.R., 2015. Assimilation of dual-polarization radar observations in mixed- and ice-phase regions of convective storms: Information content and forward model errors. *Monthly Weather Review*, 143(7): 2611–2636.

Rathore, M.M.U., Paul, A., Ahmed, A., Chen, B.-W., Huang, B., and Ji, W., 2015. Real-time big data analytical architecture for remote sensing application. *IEEE Journal of Selected Topics in Applied Earth Observations and Remote Sensing*, 8(10): 4610-4621.

Reid, J.S., Lagrosas, N.D., Jonsson, H.H., Reid, E.A., Sessions, W.R., Simpas, J.B., Uy, S.N., Boyd, T.J., Atwood, S.A., Blake, D.R., Campbell, J.R., Cliff, S.S., Holben, B.N., Holz, R.E., Hyer, E.J., Lynch, P., Meinardi, S., Posselt, D.J., Richardson, K.A., Salinas, S.V., Smirnov, A., Wang, Q., Yu, L., and Zhang, J., 2015. Observations of the temporal variability in aerosol properties and their relationships to meteorology in the summer monsoonal South China Sea/East Sea: the scale-dependent role of monsoonal flows, the Madden-Julian Oscillation, tropical cyclones, squall lines and cold pools. *Atmospheric Chemistry and Physics*, 15(4): 1745-1768.

Roebing, R., Baum, B., Bennartz, R., Hamann, U., Heidinger, A., Meirink, J.F., Stengle, M., Thoss, A., Walther, A., and Watts, P., 2015. Summary of the fourth Cloud Retrieval Evaluation Workshop. *Bulletin of the American Meteorological Society*, 96(4): ES71–ES74.

Roman, J., Knuteson, R., Ackerman, S., and Revercomb, H., 2015. Predicted changes in the frequency of extreme precipitable water vapor events. *Journal of Climate*, 28(18): 7057–7070.

Rozoff, C.M., Velden, C.S., Kaplan, J., Kossin, J.P., and Wimmers, A.J., 2015. Improvements in the probabilistic prediction of tropical cyclone rapid intensification with passive microwave observations. *Weather and Forecasting*, 30(4): 1016-1038.

Saide, P.E., Spak, S.N., Pierce, R.B., Otkin, J.A., Schaack, T.K., Heidinger, A.K., da Silva, A.M., Kacenenbogen, M., Redemann, J., and Carmichael, G.R., 2015. Central American biomass burning smoke can increase tornado severity in the U.S. *Geophysical Research Letters*, 42(3): 956-965.

Schmetz, J. and Menzel, W.P., 2015. A look at the evolution of meteorological satellites: Advancing capabilities and meeting user requirements. *Weather, Climate, and Society*, 7(4): 309–320.

Schmit, T.J., Goodman, S.J., Gunshor, M.M., Sieglaff, J., Heidinger, A.K., Bachmeier, A.S., Lindstrom, S.S., Terborg, A., Feltz, J., Bah, K., Rudlosky, S., Lindsey, D.T., Rabin, R.M., and Schmidt, C.C., 2015. Rapid refresh information of significant events: Preparing users for the next generation of geostationary operational satellites. *Bulletin of the American Meteorological Society*, 96(4): 561–576, supplement.

Shapiro, A., Rahimi, S., Rotvin, C.K., and Orf, L., 2015. On the use of advection correction in trajectory



calculations. *Journal of the Atmospheric Sciences*, 72(11): 4261–4280.

Smith, N., Smith, W.L.Sr., Weisz, E., and Revercomb, H.E., 2015. AIRS, IASI, and CrIS retrieval records at climate scales: An investigation into the propagation of systematic uncertainty. *Journal of Applied Meteorology and Climatology*, 54(7): 1465-1481.

Stengel, M., Mieruch, S., Jerg, M., Karlsson, C.-G., Scheirer, R., Maddux, B., Meirink, J.F., Poulsen, C., Siddans, R., Walther, A., and Hollman, R., 2015. The Cloud Climate Change Initiative: Assessment of state-of-the-art cloud property retrieval schemes applied to AVHRR heritage measurements. *Remote Sensing of Environment*, 162: 363-379.

Straka, W.C.I., Seaman, C.J., Baugh, K., Cole, K., Stevens, E., and Miller, S.D., 2015. Utilization of the Suomi National Polar-Orbiting Partnership (NPP) Visible Infrared Imaging Radiometer Suite (VIIRS) day/night band for Arctic ship tracking and fisheries management. *Remote Sensing*, 7(1): 971-989.

Sullivan, J.T., McGee, T.J., Thompson, A.M., Pierce, R.B., Sumnicht, G.K., Twigg, L.W., Eloranta, E., and Hoff, R.M., 2015. Characterizing the lifetime and occurrence of stratospheric-tropospheric exchange events in the rocky mountain region using high-resolution ozone measurements. *Journal of Geophysical Research-Atmospheres*, 120(24): 12410–12424.

Sun, B., Free, M., You, H.L., Foster, M.J., Heidinger, A., and Karlsson, K.-G. , 2015. Variability and trends in US cloud cover: ISCCP, PATMOS-x, and CLARA-A1 compared to homogeneity-adjusted weather observations. *Journal of Climate*, 28(11): 4373–4389.

Volkamer, R., Baidar, S., Campos, T.L., Coburn, S., DiGangi, J.P., Dix, B., Eloranta, E.W., Koenig, T.K., Morley, B., Ortega, I., Pierce, B.R., Reeves, M., Sinreich, R., Wang, S., Zondlo, M.A., and Romanshkin, P.A., 2015. Aircraft measurements of BrO, IO, glyoxal, NO<sub>2</sub>, H<sub>2</sub>O, O<sub>2</sub>-O<sub>2</sub> and aerosol extinction profiles in the tropics: Comparison with aircraft-/ship-based in situ and lidar measurements. *Atmospheric Measurement Techniques*, 8(5): 2121-2148, supplement.

Volkamer, R., Baidar, S., Campos, T.L., Coburn, S., DiGangi, J.P., Dix, B., Eloranta, E.W., Koenig, T.K., Morley, B., Ortega, I., Pierce, B.R., Reeves, M., Sinreich, R., Wang, S., Zondlo, M.A., and Romanshkin, P.A., 2015. Supplement to: Aircraft measurements of BrO, IO, glyoxal, NO<sub>2</sub>, H<sub>2</sub>O, O<sub>2</sub>-O<sub>2</sub> and aerosol extinction profiles in the tropics: Comparison with aircraft-/ship-based in situ and lidar measurements. *Atmospheric Measurement Techniques*, 8(5): 2121-2148, supplement.

Walsh, K.J.E., Camargo, S.J., Vechhi, G.A. , Daloz, A.S., Elsner, J., Emanuel, K., Horn, M., Lim, Y.-K., Roberts, M., Patricola, C., Scoccimarro, E., Sobel, A.H. , Strazzo, S., Villarini, G., Wehner, M. , Zhao, M., Kossin, J.P., LaRow, T., Oouchi, K., Schubert, S., Wang, H., Bachmeister, J., Chang, P., Chauvin, F., Jablonowski, C., Kumar, A., Murakami, K., Ose, T., Reeed, K.A., Saravanan, R., Yamada, Y., Zarzycki, C.M., Vidale, P.L., Honas, J.A., and Henderson, N., 2015. Hurricanes and climate: The US CLIVAR Working Group on Hurricanes. *Bulletin of the American Meteorological Society*, 96(6): 997–1017.

Wang, K., Yahya, K., Zhang, Y., Hogrefe, C., Pouliot, G., Knote, C., Hodzic, A., San Jose, R., Perez, J.L., Jimenez-Guerrero, P., Baro, R., Makar, P., and Bennartz, R., 2015. A multi-model assessment for the 2006 and 2010 simulations under the Air Quality Model Evaluation International Initiative (AQMEII) Phase 2 over North America: Part II. Evaluation of column variable predictions using satellite data. *Atmospheric Environment*, 115: 587-603.

Wang, P., Li, J., Goldberg, M.D., Schmit, T.J., Lim, A.H.N., Li, Z., Han, H., Li, J., and Ackerman, S.A., 2015. Assimilation of thermodynamic information from advanced infrared sounders under partially cloudy skies from regional NWP. *Journal of Geophysical Research-Atmospheres*, 120(16): 5469-5484.

Wang, S., Schmidt, J.A., Baidar, S., Coburn, S., Dix, B., Koenig, T.K., Apel, E., Bowdalo, D., Campos, T.L., Eloranta, E., Evans, M.J., DiGangi, J.P., Zondlo, M.A., Gao, R.-S., Haggerty, J.A., Hall, S.R.,



Hornbrook, R.S., Jacob, D., Morley, B., Pierce, B., Reeves, M., Romashkin, P., ter Schure, A., and Valkamer, R., 2015. Active and widespread halogen chemistry in the tropical and subtropical free troposphere. *Proceedings of the national Academy of Sciences of the United States of America*, 112(30): 9281-9286.

Weisz, E., Smith, N., and Smith, W.L.Sr., 2015. The use of hyperspectral sounding information to monitor atmospheric tendencies leading to severe local storms. *Earth and Space Science*, 2(9): 369–377.

Wood, N.B., L'Ecuyer, T.S., Heymsfield, A.J., and Stephens, G.L., 2015. Microphysical constraints on millimeter-wavelength scattering properties of snow particles. *Journal of Applied Meteorology and Climatology*, 54(4): 909–931.

Wu, J., Kong, W., Mielikainen, J., and Huang, B., 2015. Lossless compression of hyperspectral imagery via clustered differential pulse code modulation with removal of local spectral outliers. *IEEE Signal Processing Letters*, 23(12): 2194-2198.

Wu, T.-C., Velden, C.S., Majumdar, S.J., Liu, H., and Anderson, J.L., 2015. Understanding the influence of assimilating subsets of enhanced atmospheric motion vectors on numerical analyses and forecasts of tropical cyclone track and intensity with an ensemble Kalman filter. *Monthly Weather Review*, 143(7): 2506–2531 .

Xu, J., Li, Q., Yue, J., Hoffmann, L., Straka, W.C.I., Wang, C., Liu, M., Yuan, W., Han, S., Miller, S.D., Sun, L., Liu, X., Liu, W., Yang, J., and Ning, B., 2015. Concentric gravity waves over northern China observed by an airglow imager network and satellites. *Journal of Geophysical Research-Atmospheres*, 120(21): 11058-11078.

Yan, J., Wang, L., Chen, L., Zhao, L., and Huang, B., 2015. A dynamic remote sensing data-driven approach for oil spill simulation in the sea. *Remote Sensing*, 7(6): 7105-7125.

Yang, P., Liou, K.-N., Bi, L., Liu, C., Yi, B., and Baum, B.A., 2015. On the radiative properties of ice clouds: Light scattering, remote sensing, and radiation parameterization. *Advances in Atmospheric Sciences*, 32(1): 32-63.

Yao, Z., Li, J., and Zhao, Z., 2015. Synergistic use of AIRS and MODIS for dust top height retrieval over land. *Advances in Atmospheric Sciences*, 32: 470-476.

Yates, E.L., Iraci, L.T., Austerberry, D., Pierce, R.B., Roby, M.C., Tadic, J.M., Loewenstein, M., and Gore, W., 2015. Characterizing the impacts of vertical transport and photochemical ozone production on an exceedance area. *Atmospheric Environment*, 109: 342-350.

## 2014

Alfaro-Contreras, R., Zhang, J., Campbell, J.R., Holz, R.E., and Reid, J.S., 2014. Evaluating the impact of aerosol particles above cloud on cloud optical depth retrievals from MODIS. *Journal of Geophysical Research-Atmospheres*, 119(9): 5410–5423.

Bagley, J.E., Desai, A.R., Harding, K.J., Snyder, P.K., and Foley, J.A., 2014. Drought and deforestation: Has land cover change influenced recent precipitation extremes in the Amazon? *Journal of Climate*, 27(1): 345–361.

Bai, W., Wu, C., Li, J., and Wang, W., 2014. Impact of terrain altitude and cloud height on ozone remote sensing from satellite. *Journal of Atmospheric and Oceanic Technology*, 31(4): 903-912.



Baker, W.E., Atlas, R., Cardinali, C., Clement, A., Emmitt, G.D., Gentry, B.M., Hardesty, R.M., Kallen, E., Kavaya, M.J., Langland, R., Ma, Z., Masutani, M., McCarty, W., Pierce, R.B., Pu, Z., Riishojgaard, L.P., Ryan, J., Tucker, S., Weissmann, M., and Yoe, J.G., 2014. Lidar-Measured wind profiles: The missing link in the global observing system. *Bulletin of the American Meteorological Society*, 95(4): 543–564.

Ban-Weiss, G.A., Jin, L., Bauer, S.E., Bennartz, R., Liu, X., Zhang, K., Ming, Y., Guo, H., and Jiang, J.H., 2014. Evaluating clouds, aerosols, and their interactions in three global climate models using satellite simulators and observations. *Journal of Geophysical Research-Atmospheres*, 119(18): 10,876–10,901.

Baum, B.A., Yang, P., Heymsfield, A.J., Bansemmer, A., Cole, B.H., Merrelli, A., Schmitt, C., and Wang, C., 2014. Ice cloud single-scattering property models with the full phase matrix at wavelengths from 0.2 to 100 microns. *Journal of Quantitative Spectroscopy and Radiative Transfer*, 146: 123-139.

Bi, L., Yang, P., Liu, C., Yi, B., Baum, B.A., van Diedenhoven, B., and Iwabuchi, H., 2014. Assessment of the accuracy of the conventional ray-tracing technique: Implications in remote sensing and radiative transfer involving ice clouds. *Journal of Quantitative Spectroscopy and Radiative Transfer*, 146: 158-174.

Bormann, N., Hernandez-Carrascal, A., Borde, R., Lutz, H.-J., Otkin, J.A., and Wanzong, S., 2014. Atmospheric Motion Vectors from model simulations. Part I: Methods and characterization as single-level estimates of wind. *Journal of Applied Meteorology and Climatology*, 53(1): 47–64.

Cintineo, J.L., Pavolonis, M.J., Sieglaff, J.M., and Lindsey, D.T., 2014. An empirical model for assessing the severe weather potential of developing convection. *Weather and Forecasting*, 29(3): 639–653.

Cintineo, R., Otkin, J.A., Xue, M., and Kong, F., 2014. Evaluating the performance of planetary boundary layer and cloud microphysical parameterization schemes in convection-permitting ensemble forecasts using synthetic GOES-13 satellite observations. *Monthly Weather Review*, 142(1): 163-182.

Cole, B.H., Yang, P., Baum, B.A., Riedi, J., and Labonnote, L.C., 2014. Ice particle habit and surface roughness derived from PARASOL polarization measurements. *Atmospheric Chemistry and Physics*, 14(3739-3750).

Deb, S.K., Wanzong, S., Velden, C.S., Kaur, I., Kishtawal, C.M., Pal, P.K., and Menzel, W.P., 2014. Height assignment improvement in Kalpana-1 Atmospheric Motion Vectors. *Journal of the Indian Society of Remote Sensing*, doi:10.1007/s1254-013-0278-z.

Divakarla, M., Barnet, C., Liu, X., Gu, D., Wilson, M., Kizer, S., Xiong, X., Maddy, E., Ferraro, R., Knuteson, R., Hagan, D., Ma, X., Tan, C., Nalli, N., Reale, A., Mollner, A.K., Yang, W., Gambacorta, A., Feltz, M., Iturbide-Sanchez, F., Sun, B., and Guldborg, 2014. The CrIMSS EDR algorithm: Characterization, optimization, and validation. *Journal of Geophysical Research-Atmospheres*, 119(8): 4953–4977 .

Duncan, B.N., Prados, A.L., Lamsal, L.N., Liu, Y., Streets, D.G., Gupta, P., Hilsenrath, E., Kahn, R.A., Nielsen, J.E., Beyersdorf, A.J., Burton, S.P., Fiore, A.M., Fishman, J., Henze, D.K., Hostetler, C.A., Krotkov, N.A., Lee, P., Lin, M., Pawson, S., Pfister, G., Pickering, K.E., Pierce, R.B., Yoshida, Y., and Ziemba, L.D., 2014. Satellite data of atmospheric pollution for US air quality applications: Examples of applications, summary of data end-user resources, answers to FAQs, and common mistakes to avoid. *Atmospheric Environment*, 94: 647-662.

Dunion, J.P., Thorncroft, C.D., and Velden, C.S., 2014. The tropical cyclone diurnal cycle of mature hurricanes. *Monthly Weather Review*, 142(10): 3900–3919.

Feltz, M., Knuteson, R., Ackerman, S., and Revercomb, H., 2014. Application of GPS radio occultation to the assessment of temperature profile retrievals from microwave and infrared sounders. *Atmospheric Measurement Techniques*, 7(11): 3751-3762.



Feltz, M.L., Knuteson, R.O., Revercomb, H.E., and Tobin, D.C., 2014. A methodology for the validation of temperature profiles from hyperspectral infrared sounders using GPS radio occultation: Experience with AIRS and COSMIC. *Journal of Geophysical Research - Atmospheres*, 119(3): 1680-1691.

Foster, M.J. and Heidinger, A., 2014. Entering the era of +30-year satellite cloud climatologies: A North American case study. *Journal of Climate*, 27(17): 6687-6697.

Gultepe, I., Kuhn, T., Pavlonis, M., Calvert, C., Gurka, J., Heymsfield, A.J., Lui, P.S.K., Zhou, B., Ware, R., Ferrier, B., Milbrandt, J., and Bernstein, B., 2014. Ice fog in Arctic during FRAM-Ice Fog Project: Aviation and nowcasting applications. *Bulletin of the American Meteorological Society*, 95(2): 211–226.

Hamann, U., Walther, A., Baum, B., Bennartz, R., Bugliaro, L., Derrien, M., Francis, P.N., Heidinger, A., Joro, S., Kniffka, A., Le Gleau, H., Lockhoff, M., Lutz, H.-J., Meirink, J.F., Minnis, P., Palikonda, R., Roebeling, R., Thoss, A., Platnick, S., Watts, P., and Wind, G., 2014. Remote sensing of cloud top pressure/height from SEVIRI: Analysis of ten current retrieval algorithms. *Atmospheric Measurement Techniques*, 7(9): 2839-2867.

Heidinger, A.K., Foster, M.J., Walther, A., and Zhao, X.T., 2014. The Pathfinder-Atmospheres Extended AVHRR climate dataset. *Bulletin of the American Meteorological Society*, 95(6): 909-922.

Huang, M., Bowman, K.W., Carmichael, G.R., Chai, T., Pierce, R.B., Worden, J.R., Luo, M., Pollack, I.B., Ryerson, T.B., Nowak, J.B., Neuman, J.A., Roberts, J.M., Atlas, E.L., and Blake, D.R., 2014. Changes in nitrogen oxides emissions in California during 2005-2010 indicated from top-down and bottom-up emission estimates. *Journal of Geophysical Research-Atmospheres*, 119(22): 12,928–12,952.

Hutchison, K.D., Heidinger, A.K., Kopp, T.J., Iisager, B.D., and Frey, R.A., 2014. Comparisons between VIIRS cloud mask performance results from manually generated cloud masks of VIIRS imagery and CALIOP-VIIRS match-ups. *International Journal of Remote Sensing*, 35(13): 4905-4922.

Ibrahim, W.Y., Batzli, S., and Menzel, W.P., 2014. Agricultural policy effects on land cover and land use over 30 years in Tartous, Syria, as seen in Landsat imagery. *Journal of Applied Remote Sensing*, 8(1): doi:10.1117/1.JRS.8.083506.

Jie, Z., Li, Z., and Li, J., 2014. Ensemble retrieval of atmospheric temperature profiles from AIRS. *Advances in Atmospheric Sciences*, 31: 559-569.

Jones, T.A., Otkin, J.A., Stensrud, D.J., and Knopfmeier, K., 2014. Forecast evaluation of an observing system simulation experiment assimilating noth radar and satellite data. *Monthly Weather Review*, 142(1): 107-124.

Kataoka, F., Knuteson, R.O., Kuze, A., Suto, H., Shiomi, K., Harada, M., Garms, E.M., Roman, J.A., Robin, C., Taylor, J.K., Revercomb, H.E., Sekio, N., Higuchi, R., and Mitomi, Y., 2014. TIR spectral radiance calibration of the GOSAT satellite borne TANSO-FTS with the aircraft-based S-HIS and the ground-based S-AERI at the Railroad Valley Desert Playa. *IEEE Transactions on Geoscience and Remote Sensing*, 52(1): 89-105.

Kniffka, A., Stengle, M., Lockhoff, M., Bennartz, R., and Hollmann, R., 2014. Characteristics of cloud liquid water path from SEVIRI onboard the Meteosat Second Generation 2 satellite for several cloud types. *Atmospheric Measurement Techniques*, 7(4): 887-905.

Kohrs, R.A., Lazzara, M.A., Robaidek, J.O., Santek, D.A., and Knuth, S.L., 2014. Global satellite composites - 20 years of evolution. *Atmospheric Research*, 135-136: 8-24.

Kopp, T.J., Thomas, W., Heidinger, A.K., Botambekov, D., Frey, R.A., Hutchison, K.D., Iisager, B.D., Brueske, K., and Reed, B., 2014. The VIIRS cloud mask: Progress in the first year of S-NPP toward a



- common cloud detection scheme. *Journal of Geophysical Research-Atmospheres*, 119(5): 2441-2456.
- Kossin, J.P., Emanuel, K.A., and Vecchi, G.A., 2014. The poleward migration of the location of tropical cyclone maximum intensity. *Nature*, 509(7500): 349-352, appendix.
- Kulie, M.S., Hiley, M.J., Bennartz, R., Kneifel, S., and Tanelli, S., 2014. Triple-frequency radar reflectivity signatures of snow: Observations and comparisons with theoretical ice particle scattering models. *Journal of Applied Meteorology and Climatology*, 53(4): 1080-1098.
- Lazzara, M.A., Dworak, R., Santek, D.A., Hoover, B.T., Velden, C.S., and Key, J.R., 2014. High-latitude atmospheric motion vectors from composite satellite data. *Journal of Applied Meteorology and Climatology*, 53(2): 534–547.
- Lee, Y.-K., Li, Z., Li, J., and Schmit, T.J., 2014. Evaluation of the GOES-R ABI LAP retrieval algorithm using the GOES-13 sounder. *Journal of Atmospheric and Oceanic Technology*, 31(1): 3-19.
- Lee, Y.-K., Otkin, J.A., and Greenwald, T.J., 2014. Evaluating the accuracy of a high-resolution model simulation through comparison with MODIS observations. *Journal of Applied Meteorology and Climatology*, 53(4): 1046–1058.
- Li, Z., Grotenhuis, M., Wu, X., Schmit, T.J., Schmidt, C., Schreiner, A.J., Nelson, J.P.I., Yu, F., and Bysal, H., 2014. Geostationary Operational Environmental Satellite Imager infrared channel-to-channel co-registration characterization algorithm and its implementation in the ground system. *Journal of Applied Remote Sensing*, 8: doi:10.1117/1.JRS.8.083530.
- Lim, A.H.N., Jung, J.A., Huang, H.-L.A., Ackerman, S.A., and Otkin, J.A., 2014. Assimilation of clear sky Atmospheric Infrared Sounder radiances in short-term regional forecasts using community models. *Journal of Applied Remote Sensing*, 8(1): doi:10.1117/1.JRS.8.083655.
- Liu, H., Remer, L.A., Huang, J., Huang, H.-C., Kondragunta, S., Laszlo, I., Oo, M., and Jackson, J.M., 2014. Preliminary evaluation of S-NPP VIIRS aerosol optical thickness. *Journal of Geophysical Research-Atmospheres*, 119(7): 3942-3962.
- Liu, Y. and Key, J.R., 2014. Less winter cloud aids summer 2013 Arctic sea ice return from 2012 minimum. *Environmental Research Letters*, 9(4): doi:10.1088/1748-9326/9/4/044002.
- Masiello, G., Serio, C., Venafra, S., DeFeis, I., and Borbas, E.E., 2014. Diurnal variation in Sahara desert sand emissivity during the dry season from IASI observations. *Journal of Geophysical Research-Atmospheres*, 119(3): 1626-1638.
- Meier, W.N., Hovelsrud, G.K., van Oort, B.E.H., Key, J.R., Kovasc, K.M., Michel, C., Haas, C., Granskog, M.A., Gerland, S., Perovich, D.K., Makshtas, A., and Reist, J.D., 2014. Arctic sea ice in transformation: A review of recent observed changes and impacts on biology and human activity. *Reviews in Geophysics*, 51: doi:10.1002/2013RG000431.
- Mielikainen, J., Huang, M., Huang, B., and Huang, A.H.L., 2014. Comments on the paper by Huandong Xiao, Jing Sun, Xiaofeng Bian and Zhijun Dai, "GPU acceleration of the WSM6 cloud microphysics scheme in GRAPES model". *Computers and Geosciences*, 72: 262-263.
- Miller, S.D., Noh, Y.-Y., and Heidinger, A.K., 2014. Liquid-top mixed-phase cloud detection from shortwave-infrared satellite radiometer observations: A physical basis. *Journal of Geophysical Research-Atmospheres*, 119(13): 8245–8267.
- Monette, S.A. and Sieglaff, J.M., 2014. Probability of convectively induced turbulence associated with geostationary satellite-inferred cloud-top cooling. *Journal of Applied Meteorology and Climatology*, 53(2):



429–436.

Murino, L., Amato, U., Carfora, M.F., Antoniadis, A., Huang, B., Menzel, W.P., and Serio, C., 2014. Cloud detection of MODIS multispectral images. *Journal of Atmospheric and Oceanic Technology*, 31(2): 347–365.

Otkin, J.A., Anderson, M.C., Hain, C., and Svoboda, M., 2014. Examining the relationship between drought development and rapid changes in the Evaporative Stress Index. *Journal of Hydrometeorology*, 15(3): 938–956.

Price, E., Mielikainen, J., Huang, M., Huang, B., Huang, H.-L.A., and Lee, T., 2014. GPU-accelerated longwave radiation scheme of the Rapid Radiative Transfer Model for General Circulation Models (RRTMG). *IEEE Journal of Selected Topics in Applied Earth Observations and Remote Sensing*, 7(8): doi:10.1109/JSTARS.2014.2315771.

Roman, J., Knuteson, R., and Ackerman, S., 2014. Time-to-detect trends in precipitable water vapor with varying measurement error. *Journal of Climate*, 27(21): 8259–8275.

Schrenck, C.J.I., Knapp, K.R., and Kossin, J.P., 2014. The impact of best track discrepancies on global tropical cyclone climatologies using IBTrACS. *Monthly Weather Review*, 142(10): 3881–3899.

Sieglauff, J.M., Cronce, L.M., and Feltz, W.F., 2014. Improving satellite-based convective cloud growth monitoring with visible optical depth retrievals. *Journal of Applied Meteorology and Climatology*, 53(2): 506–520.

Split, M.E., Lazarus, S.M., Collins, S., Botambekov, D.N., and Roeder, W.P., 2014. Probability distributions and threshold selection for Monte Carlo-type tropical cyclone wind speed forecasts. *Weather and Forecasting*, 25(5): 1155–1168.

Stafanescu, E.R., Patra, A.K., Bursik, M.I., Mandankan, R., Pouget, S., Jones, M., Singla, P., Singh, T., Pitman, E.B., Pavolonis, M., Morton, D., Webley, P., and Dehn, J., 2014. Temporal, probabilistic mapping of ash clouds using wind field stochastic variability and uncertain eruption source parameters: Example of the 14 April 2010 Eyjafjallajökull eruption. *Journal of Advances in Modeling Earth Systems*, 6(4): 1173–1184.

Su, X., Huang, B., Plaza, A., Li, Y., and Wu, C., 2014. Real-time implementation of the pixel purity index algorithm for endmember identification on GPUs. *IEEE Geoscience and Remote Sensing Letters*, 11(5): 955–959.

Sun-Mack, S., Minnis, P., Chen, Y., Kato, S., Yi, Y., Gibson, S.C., Heck, P.W., and Winker, D.M., 2014. Regional apparent boundary layer lapse rates determined from CALIPSO and MODIS data for cloud-height determination. *Journal of Applied Meteorology and Climatology*, 53(4): 990–1011.

Terwey, W.D. and Rozoff, C.M., 2014. Objective convective updraft identification and tracking: Part 1. Structure and thermodynamics of convection in the rainband regions of two hurricane simulations. *Journal of Geophysical Research-Atmospheres*, 119(11): 6470–6496.

Velden, C.S. and Sears, J., 2014. Computing deep-tropospheric vertical wind shear analyses for tropical cyclone applications: Does the methodology matter? *Weather and Forecasting*, 25(5): 1169–1180.

Vidot, J. and Borbas, E., 2014. Land surface VIS/NIR BRDF atlas for RTTOV-11: Model and validation against SEVIRI land SAF albedo product. *Quarterly Journal of the Royal Meteorological Society*, 140(684): 2186–2196.

Walker, N.D., Leben, R.R., Pilley, C.T., Shannon, M., Herndon, D.C., Pun, I.-F., Lin, I.-I., and Gentemann,





C.L., 2014. Slow translation speed causes rapid collapse of northeast Pacific Hurricane Kenneth over cold core eddy. *Geophysical Research Letters*, 41(21): 7595-7601.

Wang, C., Yang, P., Dessler, A., Baum, B.A., and Hu, Y., 2014. Estimation of the cirrus cloud scattering phase function from satellite observations. *Journal of Quantitative Spectroscopy and Radiative Transfer*, 138: 36-49.

Wang, P., Li, J., Li, J., Li, Z., Schmit, T.J., and Bai, W., 2014. Advanced infrared sounder subpixel cloud detection with imagers and its impact on radiance assimilation in NWP. *Geophysical Research Letters*, 41(5): 1773-1780.

Wei, S.-C., Huang, B., and Huang, L.-L.A., 2014. Graphics processing unit implementation of the maximum likelihood solution to the inverse problem for retrieval of geophysical parameters from high-resolution sounder data. *Journal of Applied Remote Sensing*, 8(1): doi:10.1117/1.JRS.8.084799.

Wood, N.B., L'Ecuyer, T.S., Heymsfield, A.J., Stephens, G.L., Hudak, D.R., and Rodriguez, P., 2014. Estimating snow microphysical properties using collocated multisensor observations. *Journal of Geophysical Research-Atmospheres*, 119(14): 8941–8961.

Wu, T.-C., Liu, H., Majumdar, S.J., Velden, C.S., and Anderson, J.L., 2014. Influence of assimilating satellite-derived Atmospheric Motion Vector observations on numerical analyses and forecasts of tropical cyclone track and intensity. *Monthly Weather Review*, 142(1): 49-71.

Wu, W., Liu, Y., Jensen, M.P., Toto, T., Foster, M.J., and Long, C.N., 2014. A comparison of multiscale variations of decade-long cloud fractions from six different platforms over the Southern Great Plains in the United States. *Journal of Geophysical Research-Atmospheres*, 119(6): 3438–3459.

Yi, B., Huang, X., Yang, P., Baum, B.A., and Kattawar, G.W., 2014. Considering polarization in MODIS-based cloud property retrievals by using a vector radiative transfer code. *Journal of Quantitative Spectroscopy and Radiative Transfer*, 146: 540-548.

Yi, B., Yang, P., and Baum, B.A., 2014. Impact of pollution on the optical properties of trans-Pacific East Asian dust from satellite and ground-based measurements. *Journal of Geophysical Research-Atmospheres*, 119(9): 5397–5409.

Yue, J., Miller, S.D., Hoffmann, L., and Straka, W.C.I., 2014. Stratospheric and mesospheric concentric gravity waves over tropical cyclone Mahasen: Joint AIRS and VIIRS satellite observations. *Journal of Atmospheric and Solar-Terrestrial Physics*, 119: 83-90.

Zhang, Y., Li, Z., and Li, J., 2014. Comparisons of emissivity observations from satellites and the ground at the CRCS Dunhuang Gobi site. *Journal of Geophysical Research-Atmospheres*, 119(22): 13,026–13,041.

## 2013

Ackerman, S.A., Heidinger, A., Foster, M.J., and Maddux, B., 2013. Satellite regional cloud climatology over the Great Lakes. *Remote Sensing*, 5: 6223-6240.

Anderson, M.C., Hain, C., Otkin, J., Zhan, X., Mo, K., Svoboda, M., Wardlow, B., and Pimstein, A., 2013. An intercomparison of drought indicators based on thermal remote sensing and NLDAS-2 simulations with U.S. drought monitor classifications. *Journal of Hydrometeorology*, 14 (4): 1035–1056.

Bennartz, R., Shupe, M.D., Turner, D.D., Walden, V.P., Steffen, K., Cox, C.J., Kulie, M.S., Miller, N.B., and Pettersen, C., 2013. July 2012 Greenland melt extent enhanced by low-level liquid clouds. *Nature*,



496(7443): 83-86.

Chen, R., Cao, C., and Menzel, W.P., 2013. Intersatellite calibration of NOAA HIRS CO<sub>2</sub> channels for climate studies. *Journal of Geophysical Research-Atmospheres*, 118(11): doi:10.1002/jgrd.50447.

Cintineo, J.L., Pavolonis, M.J., Sieglaff, J.M., and Heidinger, A.K., 2013. Evolution of severe and nonsevere convection inferred from GOES-derived cloud properties. *Journal of Applied Meteorology and Climatology*, 52(9): 2009–2023.

Cole, B.H., Yang, P., Baum, B.A., Piedi, J., Labonnote, L.C., Thieuleux, F., and Platnick, S., 2013. Comparison of PARASOL observations with polarized reflectances simulated using different ice habit mixtures. *Journal of Applied Meteorology and Climatology*, 52(1): 186-196.

Cross, J., Gladkova, I., Menzel, W.P., Heidinger, A., and Grossberg, M.D., 2013. Statistical estimation of a 13.3 micron Visible Infrared Imaging Radiometer Suite channel using multisensor data fusion. *Journal of Applied Remote Sensing*, 7(1): doi:10.1117/1.JRS.7.073473.

Delcambre, S.C., Lorenz, D.J., Vimont, D.J., and Martin, J.E., 2013. Diagnosing Northern Hemisphere jet portrayal in 17 CMIP3 Global Climate Models: Twenty-first-century projections. *Journal of Climate*, 26(14): 4930-4946.

Ding, S., Yang, P., Baum, B.A., Heidinger, A., and Greenwald, T., 2013. Development of a GOES-R Advanced Baseline Imager solar channel radiance simulator for ice clouds. *Journal of Applied Meteorology and Climatology*, 52(4): 872–888.

Foster, M.J., Ackerman, S.A., Heidinger, A.K., and Maddux, B.C., 2013. State of the climate in 2012: Cloudiness. *Bulletin of the American Meteorological Society*, 94(8): S21-S22.

Foster, M.J. and Heidinger, A., 2013. PATMOS-x: Results from a diurnally corrected 30-yr satellite cloud climatology. *Journal of Climate*, 26(2): 414–425.

Gladkova, I., Shahriar, F., Grossberg, M., Frey, R.A., and Menzel, W.P., 2013. Impact of the Aqua MODIS Band 6 Restoration on Cloud/Snow Discrimination. *Journal of Climate*, 30(12): 2712–2719.

Han, Y., Revercomb, H., Cromp, M., Gu, D., Johnson, D., Mooney, D., Scott, D., Strow, L., Bingham, G., Borg, L., Chen, Y., DeSlover, D., Esplin, M., Hagan, D., Jin, X., Knuteson, R., Motteler, H., Predina, J., Suwinski, L., Taylor, J., Tobin, D., Tremblay, D., Wang, C., Wang, L., Wang, L., and Zavyalov, V., 2013. Suomi NPP CrIS measurements, sensor data record algorithm, calibration and validation activities, and record data quality. *Journal of Geophysical Research-Atmospheres*, 118(22): doi:10.1002/2013JD020344.

Hartung, D.C., Sieglaff, J.M., Crouce, L.M., and Feltz, W.F., 2013. An intercomparison of UW cloud-top cooling rates with WSR-88D radar data. *Weather and Forecasting*, 28(2): 463–480.

Heidinger, A.K., Laszlo, I., Molling, C.C., and Tarpley, D., 2013. Using SURFRAD to verify the NOAA single-channel land surface temperature algorithm. *Journal of Climate*, 30(12): 2868–2884.

Hillger, D., Kopp, T., Lee, T., Lindsey, D., Seaman, C., Miller, S., Solbrig, J., Kidder, S., Bachmeier, S., Jasmin, T., and Rink, T., 2013. First-light imagery from Suomi NPP VIIRS. *Bulletin of the American Meteorological Society*, 94(7): 1019-1029.

Hlavka, D.L., Yorks, J.E., Young, S.A., Vaughan, M.A., Kuehn, R.E., McGill, M.J., and Rodier, S., 2013. Airborne validation of cirrus cloud properties derived from CALIPSO lidar measurements: Optical properties. *Journal of Geophysical Research-Atmospheres*, 117(D19): doi:10.1029/2011JD017053.

Hoover, B.T., Velden, C.S., and Majumdar, S.J., 2013. Physical mechanisms underlying selected adaptive



sampling techniques for tropical cyclones. *Monthly Weather Review*, 141(11): 4008–4027.

Huang, M., Bowman, K.W., Carmichael, G.R., Pierce, R.B., Worden, H.M., Luo, M., Cooper, O.R., Pollack, I.B., Ryerson, T.B., and Brown, S.S., 2013. Impact of Southern California anthropogenic emissions on ozone pollution in the mountain states: model analysis and observational evidence from space. *Journal of Geophysical Research-Atmospheres*, 118(22): doi:10.1002/2013JD020205.

Hyer, E.J., Reid, J.S., Prins, E.M., Hoffman, J.P., Schmidt, C.C., Meittinen, J.I., and Giglio, L., 2013. Patterns of fire activity over Indonesia and Malaysia from polar and geostationary satellite observations. *Atmospheric Research*, 122: 504-519.

Jones, T.A., Otkin, J.A., Stensrud, D.J., and Knopfmeier, K., 2013. Assimilation of satellite infrared radiances and doppler radar observations during a cool season observing system simulation experiment. *Monthly Weather Review*, 141(10): 3273–3299.

Kabatas, B., Menzel, W.P., Bilgili, A., and Gumley, L.E., 2013. Comparing ship-track droplet sizes inferred from Terra and Aqua MODIS data. *Journal of Applied Meteorology and Climatology*, 52(1): 230-241.

Key, J.R., Maloney, R., Liu, Y., Romanov, P., Tschudi, M., Appel, I., Maslanik, J., Baldwin, D., Wang, X., and Meade, P., 2013. Snow and ice products from Suomi NPP VIIRS. *Journal of Geophysical Research-Atmospheres*, 118(23): doi:10.1002/2013JD020459.

King, M.D., Platnick, S., Menzel, W.P., Ackerman, S.A., and Hubanks, P.A., 2013. Spatial and temporal distribution of clouds observed by MODIS onboard the Terra and Aqua satellites. *IEEE Transactions on Geoscience and Remote Sensing*, 51(7): 3826-3852.

Kolat, U., Menzel, W.P., Olson, E., and Frey, R., 2013. Very high cloud detection in more than two decades of HIRS data. *Journal of Geophysical Research-Atmospheres*, 118(8): doi:10.1029/2012JD018496.

Kossin, J.P., Olander, T.L., and Knapp, K.R., 2013. Trend analysis with a new global record of tropical cyclone intensity. *Journal of Climate*, 26(24): 9960–9976.

Kunkel, K.E., Karl, T.R., Brooks, H., Kossin, J., Lawrimore, J.H., Arndt, D., Bosart, L., Changnon, D., Cutter, S.L., Doesken, N., Emanuel, K., Groisman, P.Ya., Katz, R.W., Knutson, T., O'Brien, J., Paciorek, C.J., Peterson, T.C., Redmond, K., Robinson, D., Trapp, J., Vose, R., Weaver, S., Wehner, M., Wolter, K., and Wuebbles, D., 2013. Monitoring and understanding trends in extreme storms: State of Knowledge. *Bulletin of the American Meteorological Society*, 94(4): 499-514.

Mielikainen, J., Huang, B., Huang, H.-L.A., Goldberg, M.D., and Mehta, A., 2013. Speeding up the computation of WRF double-moment 6-class microphysics scheme with GPU. *Journal of Atmospheric and Oceanic Technology*, 30(12): 2896–2906.

Mielikainen, J., Huang, B., Wang, J., Huang, H.-L.A., and Goldberg, M.D., 2013. Compute Unified Device Architecture (CUDA)-based parallelization of WRF Kessler cloud microphysics scheme. *Computers and Geosciences*, 52: 292-299.

Miller, N.B., Turner, D.D., Bennartz, R., Shupe, M.D., Kulie, M.S., Cadetdu, M.P., and Walden, V.P., 2013. Surface-based inversions above central Greenland. *Journal of Geophysical Research-Atmospheres*, 118(2): doi:10.1029/2012JD018867.

Miller, S.D., Straka, W.C.I., Bachmeier, A.S., Schmit, T.J., Partain, P.T., and Noh, Y.-J., 2013. Earth-viewing satellite perspectives on the Chelyabinsk meteor event. *Proceedings of the National Academy of Sciences of the United States of America*, 110(45): 18092-18097.



Miller, S.D., Straka, W.I., Mils, S.P., Elvidge, C.D., Lee, T.F., Solbrig, J., Walther, A., Heidinger, A.K., and Weiss, S.C., 2013. Illuminating the capabilities of the Suomi National Polar-orbiting Partnership (NPP) Visible Infrared Imaging Radiometer Suite (VIIRS) day/night band. *Remote Sensing*, 5: 6717-6766.

Nalli, N.R., Barnet, C.D., Reale, A., Tobin, D., Gambacorta, A., Maddy, E.S., Joseph, E., Sun, B., Borg, L., Mollner, A.K., Morris, V.R., Liu, X., Divakarla, M., Minnett, P.J., Knuteson, R.O., King, T.S., and Wolf, W.W., 2013. Validation of satellite sounder environmental data records: Application of the Cross-track Infrared Microwave Sounder Suite. *Journal of Geophysical Research-Atmospheres*, 118(24): doi:10.1002/2013JD020436.

Otkin, J.A., Anderson, M.C., Hain, C., Mladenova, I.E., Basara, J.B., and Svoboda, M., 2013. Examining rapid onset drought development using the thermal infrared-based evaporative stress index. *Journal of Hydrometeorology*, 14(4): 1057–1074.

Pavolonis, M.J., Heidinger, A.K., and Sieglaff, J., 2013. Automated retrievals of volcanic ash and dust cloud properties from upwelling infrared measurements. *Journal of Geophysical Research-Atmospheres*, 118(3): doi:10.1002/jgrd.50173.

Pennypacker, C.R., Jakubowski, M.K., Kelly, M., Lampton, M., Schmidt, C., Stephens, S., and Tripp, R., 2013. FUEGO - Fire Urgency Estimator in Geosynchronous Orbit - A proposed early-warning fire detection system. *Remote Sensing*, 5(10): doi:10.3390/rs5105173.

Peterson, T.C., Karl, T.R., Kossin, J.P., Kunkel, K.E., Lawrimore, J.H., McMahon, J.R., Vose, R.S., and Yin, X., 2013. Changes in weather and climate extremes: State of knowledge relevant to air and water quality in the United States. *Journal of the Air and Waste Management Association*, 64(2): 184-197.

Quan, X., Huang, H.-L., Zhang, L., Weisz, E., and Cao, X., 2013. Sensitive detection of aerosol effect on simulated IASI spectral radiance. *Journal of Quantitative Spectroscopy and Radiative Transfer*, 122: 214-242.

Reid, J.S., Hyer, E.J., Johnson, R.S., Holben, B.N., Yokelson, R.J., Zhang, J., Campbell, J.R., Christopher, S.A., De Girolamo, L., Giglio, L., Holz, R.E., Kearney, C., Miettinen, J., Reid, E.A., Turk, F.J., Wang, J., Xian, P., Zhao, G., Balasubramanian, R., Chew, B.N., Janjai/Serm, Lagrosas, N., Lestari, P., Lin, N.-H., Mahmud, M., Nguyen, A.X., Norris, B., Oanh, N.T.K., Oo, M., Salinas, S.V., Welton, E.J., and Liew, S.C., 2013. Observing and understanding the Southeast Asian aerosol system by remote sensing: An initial review and analysis for the Seven Southeast Asian Studies (7SEAS) program. *Atmospheric Research*, (403-468).

Reynolds, C.A., Langland, R., Pauley, P.M., and Velden, C., 2013. Tropical cyclone data impact studies: Influence of model bias and synthetic observations. *Monthly Weather Review*, 141(12): 4373–4394.

Roebeling, R., Baum, B., Bennartz, R., Hamann, U., Heidinger, A., Thoss, A., and Walther, A., 2013. Evaluating and improving cloud parameter retrievals. *Bulletin of the American Meteorological Society*, 94(4): ES41-ES44.

Ryerson, T.B., Andrews, A.E., Angevine, W.M., Bates, T.S., Brock, C.A., Cairns, B., Cohen, R.C., Cooper, O.R., de Gouw, J.A., Fehsenfeld, F.C., Ferrare, R.A., Fischer, M.L., Flagan, R.C., Goldstein, A.H., Hair, J.W., Hardesty, R.M., Hostetler, C.A., Jimenez, J.L., Langford, A.O., McCauley, E., McKeen, S.A., Molina, L.T., Nenes, A., Oltmans, S.J., Parrish, D.D., Pederson, J.R., Pierce, R.B., Prather, K., Quinn, P.K., Seinfeld, J.H., Senff, C.J., Sorooshian, A., Stutz, J., Surratt, J.D., Trainer, M., Volkamer, R., Williams, E.J., and Wofsy, S.C., 2013. The 2010 California research at the Nexus of air quality and climate change (CalNex) field study. *Journal of Geophysical Research-Atmospheres*, 118(11): doi:10.1002/jgrd.50331.

Schmit, T.J., Goodman, S.J., Lindsey, D.T., Rabin, R.M., Bedka, K.M., Gunshor, M.M., Cintineo, J.L., Velden, C.S., Bachmeier, A.S., Lindstrom, S.S., and Schmidt, C.C., 2013. Geostationary Operational



Environmental Satellite (GOES)-14 super rapid scan operations to prepare for GOES-R. *Journal of Applied Remote Sensing*, 7(1): doi:10.1117/1.JRS.7.073462.

Segal-Rosenheimer, M., Russell, P.B., Livingston, J.M., Ramachandran, S., Redemann, J., and Baum, B.A., 2013. Retrieval of cirrus properties by Sun photometry: A new perspective on an old issue. *Journal of Geophysical Research-Atmospheres*, 118(10): doi:10.1002/jgrd.50185.

Shuai, Y., Schaaf, C., Zhang, X., Strahler, A., Roy, D., Morisette, J., Wang, Z., Nightingale, J., Nickeson, J., Richardson, A.D., Xie, D., Wang, J., Li, X., Strabala, K., and Davies, J.E., 2013. Daily MODIS 500 m reflectance anisotropy direct broadcast (DB) products for monitoring vegetation phenology dynamics. *International Journal of Remote Sensing*, 34(16): 5997-6016.

Shupe, M.D., Turner, D.D., Walden, V.P., Bennartz, R., Cadeddu, M.P., Castellani, B.B., Cox, C.J., Hudak, D.R., Kulie, M.S., Miller, N.B., Neely, R.R.I., Neff, W.D., and Rowe, P.M., 2013. High and dry: New observations of tropospheric and cloud properties above the Greenland Ice Sheet. *Bulletin of the American Meteorological Society*, 94(2): 169-186.

Sieglauff, J.M., Hartung, D.C., Feltz, W.F., Crouce, L.M., and Lakshmanan, V., 2013. A satellite-based convective cloud object tracking and multipurpose data fusion tool with application to developing convection. *Journal of Atmospheric and Oceanic Technology*, 30(3): 510–525.

Smith, N., Menzel, W.P., Weisz, E., Heidinger, A.K., and Baum, B.A., 2013. A uniform space-time gridding algorithm for comparison of satellite data products: Characterization and sensitivity study. *Journal of Applied Meteorology and Climatology*, 52(1): 255-268.

Stebenrauch, C.J., Rossow, W.B., Kinne, S., Ackerman, S., Cesana, G., Chepfer, H., Di Girolamo, L., Getzewich, B., Guignard, A., Heidinger, A., Moddus, B.C., Menzel, W.P., Minnis, P., Pearls, C., Platnick, S., Poulsen, C., Riedi, J., Sun-Mack, S., Walther, A., Winker, D., Zeng, S., and Zhao, G., 2013. Assessment of global cloud datasets from satellites: Project and database initiated by the GEWEX Radiation Panel. *Bulletin of the American Meteorological Society*, 94(7): 1031–1049.

Strow, L.L., Motteler, H., Tobin, D., Revercomb, H., Hannon, S., Buijs, H., Predina, J., Sowinski, L., and Glumb, R., 2013. Spectral calibration and validation of the Cross-track Infrared Sounder on the Suomi NPP satellite. *Journal of Geophysical Research-Atmospheres*, 118(22): doi:10.1002/2013JD020480.

Studenrauch, C.J., Rossow, W.B., Kinne, S., Ackerman, S., Cesana, G., Chepfer, H., Di Girolamo, L., Getzewich, B., Guignard, A., Heidinger, A., Maddux, B.C., Menzel, W.P., Minnis, P., Pearl, C., Platnick, S., Poulsen, C., Riedi, J., Sun-Mack, S., Walther, A., Winker, D., Zeng, S., and Zhao, G., 2013. Evaluation des climatologies satellitaires globales des nuages. *La Meteorologie*, 8(82): 40-55.

Su, X., Wu, J., Huang, B., and Wu, Z., 2013. GPU-accelerated computation for electromagnetic scattering of a double-layer vegetation model. *IEEE Journal of Selected Topics in Applied Earth Observations and Remote Sensing*, 6(4): 1799-1806.

Tobin, D., Revercomb, H., Knuteson, R., Taylor, J., Best, F., Borg, L., DeSlover, D., Martin, G., Buijs, H., Esplin, M., Glumb, R., Han, Y., Mooney, D., Predina, J., Strow, L., Suwinski, L., and Wang, L., 2013. Suomi-NPP CrIS radiometric calibration uncertainty. *Journal of Geophysical Research-Atmospheres*, 118(18): doi:10.1002/jgrd.50809.

Verner, J.-P., Fairlie, T.D., Murray, J.J., Tupper, A., Trepte, C., Winker, D., Pelon, J., Garnier, A., Jumelet, J., Pavolonis, M., Omar, A.H., and Powell, K.A., 2013. An advanced system to monitor the 3D structure of diffuse volcanic ash clouds. *Journal of Applied Meteorology and Climatology*, 52(9): 2125–2138.

Walther, A., Heidinger, A.K., and Miller, S., 2013. The expected performance of cloud optical and microphysical properties derived from Suomi NPP VIIRS day/night band lunar reflectance. *Journal of*



Geophysical Research-Atmospheres, 118(23): doi:10.1002/2013JD020478.

Wang, C., Yang, P., Nasiri, S.L., Platnick, S., Baum, B.A., Heidinger, A.K., and Liu, X., 2013. A fast radiative transfer model for visible through shortwave infrared spectral reflectances in clear and cloudy atmospheres. *Journal of Quantitative Spectroscopy and Radiative Transfer*, 116: 122-131.

Wang, C., Yang, P., Platnick, S., Heidinger, A.K., Baum, B.A., Greenwald, T., Zhang, Z., and Holz, R.E., 2013. Retrieval of ice cloud properties from AIRS and MODIS observations based on a fast high-spectral-resolution radiative transfer model. *Journal of Applied Meteorology and Climatology*, 52(3): 710-726.

Weisz, E., Smith, W.L.Sr., and Smith, N., 2013. Advances in simultaneous atmospheric profile and cloud parameter regression based retrieval from high-spectral resolution radiance measurements. *Journal of Geophysical Research-Atmospheres*, 118(12): doi:10.1002/jgrd.50521.

Wielicki, B.A., Young, D.F., Mlynchak, M.G., Thome, K.J., Leroy, S., Corliss, J., Anderson, J.G., Ao, C.O., Bantges, R., Best, F., Bowman, K., Brindley, H., Butler, J.J., Collins, W., Dykema, J.A., Doelling, D.R., Feldman, D.R., Fox, N., Huang, X., Holz, R., Huang, Y., Jin, Z., Jennings, D., Johnson, D.G., Jucks, K., Kato, S., Kirk-Davidoff, D.B., Knuteson, R., Kopp, G., Kratz, D.P., Liu, X., Lukashin, C., Mannucci, A.J., Phojanamongkolkij, N., Pilewskie, P., Ramaswamy, V., Revercomb, H., Rice, J., Roberts, Y., Roithmayr, C.M., Rose, F., Sandford, S., Shirley, E.L., Smith, W.L.Sr., Soden, B., Speth, P.W., Sun, W., Taylor, P.C., Tobin, D., and Xiong, X., 2013. Achieving climate change absolute accuracy in orbit. *Bulletin of the American Meteorological Society*, 94(10): 1519–1539.

Xie, H., Nalli, N.R., Sampson, S., Wolf, W.W., Li, J., Schmit, T.J., Barnet, C.D., Joseph, E., Morris, V.R., and Yang, F., 2013. Integration and ocean-based prelaunch validation of GOES-R Advanced Baseline Imager legacy atmospheric products. *Journal of Atmospheric and Oceanic Technology*, 30(8): 1743–1756.

Yang, P., Li, L., Baum, B.A., Liou, K.-N., Kattawar, G.W., Mishchenko, M.I., and Cole, B., 2013. Spectrally consistent scattering, absorption, and polarization properties of atmospheric ice crystals at wavelengths from 0.2 to 100 microns. *Journal of the Atmospheric Sciences*, 70(1): 330-347.

Yao, Z., Li, J., Weisz, E., Heidinger, A., and Liu, C.-Y., 2013. Evaluation of single field-of-view cloud top height retrievals from hyperspectral infrared sounder radiances with CloudSat and CALIPSO measurements. *Journal of Geophysical Research-Atmospheres*, 118(16): doi:10.1002/jgrd.50681.

Yi, B., Yang, P., Baum, B.A., L'Ecuyer, T., Oreopoulos, L., Mlawer, E.J., Heymsfield, A.J., and Liou, K.-N., 2013. Influence of ice particle surface roughening on the global cloud radiative effect. *Journal of the Atmospheric Sciences*, 70(9): 2794–2807.

Zhang, Y. and Gunshor, M.M., 2013. Intercalibration of FY-2C/D/E infrared channels using AIRS. *IEEE Transactions on Geoscience and Remote Sensing*, 51(3): 1231-1244.

Zhao, T.X.P., Chan, P.K., and Heidinger, A.K., 2013. A global survey of the effect of cloud contamination on the aerosol optical thickness and its long-term trend derived from operational AVHRR satellite observations. *Journal of Geophysical Research-Atmospheres*, 118(7): doi:10.1002/jgrd.50278.

Zhou, D.K., Larar, A.M., Liu, X., Smith, W.L., and Strow, L.L., 2013. Error consistency analysis scheme for infrared ultraspectral sounding retrieval error budget estimation. *Remote Sensing Letters*, 4(3 ): 219-227.