

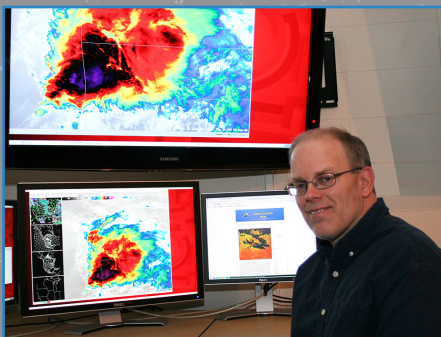
# Cooperative Agreement Annual Report

Submitted by the  
Cooperative Institute for  
Meteorological Satellite Studies  
University of Wisconsin-Madison



*Meeting our Mission's Goals*

*collaborating with NOAA,  
serving as a center of excellence,  
training the scientists  
and engineers of today  
and tomorrow...*



*30 April 2013*



**University of Wisconsin-Madison**

**Cooperative Institute for  
Meteorological Satellite Studies (CIMSS)**

<http://cimss.ssec.wisc.edu/>

---

# **Cooperative Agreement Annual Report**

**for the period**

**1 April 2012 to 31 March 2013**

**Cooperative Agreement Number: NA10NES4400013**

**Submitted to:  
National Oceanic and Atmospheric  
Administration  
(NOAA)**



# Cooperative Agreement Annual Report from the Cooperative Institute for Meteorological Satellite Studies University of Wisconsin-Madison

1 April 2012 to 31 March 2013

**Steven Ackerman**  
Director, CIMSS

**Wayne Feltz**  
Associate Director

**Thomas Achtor**  
Executive Director, SSEC

## CIMSS Contributing Task Leaders

Achter, Tom  
Ackerman, Steve  
Bachmeier, Scott  
Baum, Bryan  
Borbás, Eva  
Botambekov, Denis  
Calvert, Corey  
Cintineo, John  
Cureton, Geoff  
Feltz, Wayne  
Frey, Richard  
Foster, Mike  
Garcia, Ray  
Gerth, Jordan  
Greenwald, Tom  
Gumley, Liam  
Gunshor, Mat  
Holz, Bob  
Huang, Bormin  
Huang, Hung Lung  
Knuteson, Bob  
Kulie, Mar,  
Jasmin, Tommy  
Jung, Jim  
Lazzara, Matthew  
Lee, Yong-Keun,  
Lenzen, Allen  
Li, Jun  
Lindstrom, Scott,  
Liu, Yinghui  
Menzel, W. Paul  
Moeller, Chris  
Molling, Christine  
Mooney, Margaret  
Olander, Tim

Otkin, Jason  
Petersen, Ralph  
Revercomb, Hank  
Rink, Tom  
Rozoff, Chris  
Santek, Dave  
Schaack, Todd  
Schmidt, Chris  
Sieglaff, Justin  
Smith, Bill  
Straka, William  
Tobin, Dave  
Tripoli, Greg  
Velden, Chris  
Walther, Andi  
Wang, Xuanji  
Wanzong, Steve  
Weisz, Elisabeth  
Wimmers, Tony  
Zhang, Hong

## ASBP/NCDC Collaborators

Heidinger, Andy  
Key, Jeff  
Kossin, Jim  
Pavolonis, Mike  
Pierce, Brad  
Schmit, Tim  
Wade, Gary

## Additional Contributors

Avila, Leanne  
Hackel, Jenny  
Phillips, Jean  
Vasys, Maria



## Table of Contents

<b>I. Director’s Executive Summary .....</b>	<b>7</b>
1. Foster collaborative research between NOAA and UW-Madison in those aspects of atmospheric and earth science which exploit the use of satellite technology.....	7
2. Serve as a center at which scientists and engineers working on problems of mutual interest may focus on satellite related research in atmospheric studies and earth science.....	10
3. Stimulate the training of scientists and engineers in those disciplines comprising the atmospheric and earth sciences.....	13
<b>II. Background Information on the Cooperative Institute for Meteorological Satellite Studies (CIMSS).....</b>	<b>15</b>
1. Description of CIMSS, including research themes, vision statement and NOAA research collaborations.....	15
2. CIMSS Management and Administration.....	17
3. NOAA funding to CIMSS Cooperative Agreement NA10NES4400013 in FY2012 - summarized by Research Task, NOAA Strategic Goal and CIMSS Research and Education Themes.....	18
4. Board and Council Membership.....	22
<b>III. Project Reports.....</b>	<b>23</b>
1. CIMSS Task 1A Support.....	23
2. CIMSS Task 1B Support – Education and Outreach.....	23
3. CIMSS Participation in the 2012 GOES Improved Measurements and Product Assurance Plan (GIMPAP).....	25
3.1. Daytime Enhancement of UWCI/CTC Algorithm for Operation in Areas of Thin Cirrus.....	25
3.2. Fusing GOES Observations and RUC Model Output for Improved Cloud Remote Sensing.....	27
3.3. GOES Imager Sky Cover Analysis Product.....	30
3.4. Improvements to the Advanced Dvorak Technique (ADT).....	32
3.5. GOES Biomass Burning Research and Applications.....	35
3.6. Using GOES and NEXRAD Data to Improve Lake Effect Snowfall Estimates.....	38
3.7. Enhanced Downslope Windstorm Prediction with GOES Warning Indicators.....	41
3.8. Probabilistic Nearcasting of Severe Convection Using the Temporal Evolution of GOES-derived Deep Convective Properties, NEXRAD and NWP.....	44
4. CIMSS Participation in the Product Systems Development and Implementation (PSDI) for 2012.....	47
4.1. Operational Implementation of the CIMSS Advanced Dvorak Technique.....	47
4.2. Polar Wind Products.....	48
4.2.1. Metop-B Readiness for CLAVR-x.....	48
4.2.2. VIIRS Polar Winds.....	49
4.3. Arctic Composite Satellite Imagery.....	54
5. Cloud Products Update for NCEP and NWS Alaska (G-PSDI).....	56



6. CIMSS Infrastructure Support for Product Development, Demonstration and Operational Transition (Ground Systems) .....	59
7. Monitoring and Incorporating the Stray Light Correction Process into GOES Imager and Derived Products .....	60
8. CIMSS Participation in the GOES-R Algorithm Working Group (AWG) for 2012	63
8.1. Real-time Proxy Framework Support: CRTM Component and Validation .....	63
8.2. GOES-R Analysis Facility Instrument for Impacts on Requirements (GRAFIIR) .....	67
8.3. AIT Technical Support .....	71
8.4. GOES-R Collocation 2012 .....	73
8.5. ABI Cloud Products .....	75
8.6. Active Fire/Hot Spot Characterization (FIRE) .....	79
8.7. GOES-R Legacy Atmospheric Profile, Total Precipitable Water (TPW) and Atmospheric Instability Indices .....	81
8.8. GOES-R AWG ABI Winds .....	85
8.9. GOES-R AWG Hurricane Intensity Estimation (HIE) Algorithm .....	90
8.10. Volcanic Ash .....	91
8.11. CIMSS GOES-R Algorithm Working Group (AWG): Visibility .....	93
8.12. Imagery and Visualization .....	95
8.13. WRF-CHEM Aerosol and Ozone Proxy Data Simulations .....	97
9. CIMSS Participation in the GOES-R Risk Reduction Program for 2012 .....	100
9.1. Development of a GOES-R Automated Volcanic Cloud Alert System .....	100
9.2. Integrated GOES-R GLM/ABI Approaches for the Detection and Forecasting of Convectively Induced Turbulence .....	103
9.3. Investigating the Effects of Detector-Averaged SRFs .....	109
9.4. McIDAS-V Support for GOES-R Risk Reduction Projects .....	112
9.5. Improvements to QPE Using GOES Visible ABI and Model Data .....	113
9.6. Developing Assimilation Techniques for Atmospheric Motion Vectors Derived via a New Nested Tracking Algorithm Derived for the GOES-R Advanced Baseline Imager (ABI) .....	115
9.7. Improving GOES-R Temperature/Moisture Retrievals and Derived Products and NearCasts Using Hyper-spectral POES Soundings and Validating NearCast Products for GOES-R Proving Ground .....	117
9.8. Convective Storm Forecasting 1-6 Hours Prior to Initiation .....	124
9.9. Ensemble Simulation of GOES-R Proxy Radiance Data from CONUS Storm-Scale Ensemble Forecasts, Product Demonstration and Assessment at the Hazardous Weather Testbed GOES-R Proving Ground .....	126
9.10. Satellite Meteorology Resources and a GOES-R Education Proving Ground .....	128
9.11. Improved Understanding and Diagnosis of Tropical Cyclone Structure and Structure Changes .....	130
9.12. Continued Development of the GOES-R AWG Fog/Low Cloud Products .....	133
10. CIMSS Participation in the Development of GOES-R Proving Ground .....	137
11. X/L-Band Polar Orbiting Satellite Direct Broadcast Reception Station and Automated Processing System for the NWS, Hawaii .....	146
12. CIMSS High Impact Weather Studies with GOES-R and Advanced Soundings .....	151



13. Investigations in Support of the GOES-R Program Office.....	157
14. CIMSS Studies on Advanced IR Sounder for Geostationary Orbit.....	160
15. GOES-R Calibration/Validation Field Campaign Support.....	166
16. SSEC/CIMSS Cloud Research in Support of the Suomi NPP and JPSS Programs	
.....	173
16.1. VIIRS Cloud Mask Validation and Tool Development.....	173
16.2. VIIRS Cloud Mask Tuning and Software Support.....	175
16.3. VIIRS Cloud Mask Validation using Surface Sites.....	176
16.4. SSEC/CIMSS Cloud Research in Support of the Suomi NPP and JPSS	
Programs: Cloud Properties Algorithm .....	179
16.5. VIIRS Cloud Type Algorithm .....	181
16.6. VIIRS Cloud Team Computing Equipment Support.....	183
16.7. NPP-VIIRS Cloud Property EDR Validation Activities .....	185
16.8. CrIS/VIIRS Cloud Height Comparison .....	190
16.9. VIIRS Evaluation Using Satellite Observations .....	193
16.10. VIIRS Cloud Product ADL Support.....	194
16.11. McIDAS-V Support for Suomi NPP / JPSS .....	195
17. SSEC/CIMSS Research Tasks in Support of the Suomi NPP and JPSS Programs	
.....	198
17.1. A Broad Scope of Calibration/Validation and Independent Verification and	
Validation Activities in Support of JPSS, with Emphasis on CrIS SDRs .....	198
17.2. VIIRS Radiance Calibration/Validation .....	204
17.3. CrIMSS Post Launch EDR Assessment .....	210
17.4. CrIMSS EDR Cal/Val: ARM Site Support.....	214
17.5. Suomi NPP VIIRS Aerosol IP/EDR Evaluation.....	215
18. CIMSS Participation in the JPSS Algorithm Continuity Risk Reduction Program	
for 2012.....	219
18.1. NOAA Algorithm Continuity – Ice surface Temperature, Concentration, and	
Characterization .....	219
18.2. Transition of GOES-R AWG Cloud Algorithms to VIIRS/JPSS.....	222
18.3. Delivery of VIIRS Cloud Phase and Volcanic Ash Algorithms to NESDIS	
Operations .....	224
18.4. JPSS Algorithm Integration Team.....	226
19. Atmospheric Soundings from Suomi NPP/Aqua and Metop-A/Metop-B Sounding	
Pairs.....	228
20. CIMSS Participation in the JPSS Risk Reduction Program for 2012.....	231
20.1. Near Real-time Assimilation System Development for Improving Tropical	
Cyclone Forecasts with NPP/JPSS Sounding Measurements.....	231
20.2. Application of JPSS Imagers and Sounders to Tropical Cyclone Track and	
Intensity Forecasting.....	234
20.3. Advancing Nighttime VIIRS Cloud Products with the Day/Night Band .....	237
21. The Development of the High Performance JPSS Analysis Facility for Instrument	
Impacts on Requirements (JAFIIR).....	240
22. The Development of a Community Satellite Processing Package (CSPP) in Support	
of Suomi NPP/JPSS Real Time Regional (RTR) Applications .....	248



23. SSEC/CIMSS Participation on the Algorithm Development Library (ADL) Team .....	252
24. Science and Management Support for NPP VIIRS Snow and Ice EDRs .....	254
25. Sea Ice Thickness from Aqua and Terra Data Acquisition, Evaluation and Applications .....	257
26. Implementation of GCOM-W1 AMSR2 Snow Products .....	261
27. Detection and Characteristics of the Aurora from VIIRS on Board the Suomi NPP .....	264
28. CIMSS Science Support for the S4 Supercomputer .....	265
29. Implementation of Advanced Data Assimilation Techniques and Performance of Forecast Impact Assessment Experiments .....	267
30. Assimilation of Hyperspectral Ozone Retrievals and Radiances within GDAS to Improve Lateral Boundary Conditions for NAQFC .....	271
31. Updating the Secondary Eyewall Formation Probabilistic Model, Completing New Climatologies of Intensity and Structure Changes Associated with Eyewall Replacement Cycles .....	274
32. Real Time Prediction of Hurricanes and Investigation of Factors Influencing Numerical Intensity Prediction .....	278
33. CIMSS Cal/Val Activities in Support of the Calibration Working Group .....	282
34. CIMSS Support of STAR Calibration/Validation Activities for 2012 .....	284
35. Support for NOAA Cloud Climate Data Records .....	287
36. Reprocessing HIRS .....	289
37. CIMSS Research Activities in the VISIT Program .....	293
38. CIMSS Research Activities in the SHyMet Program .....	296
39. CIMSS Collaboration with the NWS Training Center .....	298
40. CIMSS Collaboration with the Aviation Weather Center .....	299
41. Holding Teacher Workshops in Conjunction with ESIP Meetings .....	300
<b>Appendix 1: List of Awards to Staff Members .....</b>	<b>302</b>
<b>Appendix 2: CIMSS Collaborations with other Cooperative Institutes .....</b>	<b>304</b>
<b>Appendix 3: Publications Summary .....</b>	<b>306</b>
<b>Appendix 4: CIMSS Staff and Student Hours on NOAA Cooperative Agreement Projects .....</b>	<b>308</b>
<b>Appendix 5: Research Topics of Current CIMSS Graduate Students and Post-Doctors .....</b>	<b>311</b>
<b>Appendix 6: Visitors at CIMSS 2012-2013 (visits of 3 days or more and key visitors) .....</b>	<b>317</b>
<b>Appendix 7. CIMSS Subcontracts Summary .....</b>	<b>319</b>
<b>Appendix 8. CIMSS Peer Reviewed Publications: 2011-2012 .....</b>	<b>320</b>
<b>Appendix 9. CIMSS Conference Papers and Presentations: 2011-2012 .....</b>	<b>331</b>



# **Cooperative Agreement Annual Report from the Cooperative Institute for Meteorological Satellite Studies University of Wisconsin-Madison**

**1 April 2012 to 31 March 2013**

**Steven Ackerman**  
**Director, CIMSS**

**Wayne Feltz**  
**Associate Director**

**Thomas Achtor**  
**Executive Director, SSEC**

## **I. Director's Executive Summary**

The Cooperative Institute for Meteorological Satellite Studies (CIMSS) is a collaborative relationship between the National Oceanic and Atmospheric Administration (NOAA) and the University of Wisconsin-Madison (UW-Madison). This partnership has and continues to provide outstanding benefits to the atmospheric science community and to the nation through improved use of remote sensing measurements for weather forecasting, climate analysis and monitoring environmental conditions. Under the auspices of CIMSS, scientists from NOAA/NESDIS and the UW-Madison Space Science and Engineering Center (SSEC) have a formal basis for ongoing collaborative research efforts. CIMSS scientists work closely with the NOAA/NESDIS Advanced Satellite Product Branch (ASPB) stationed at the UW-Madison campus. This collaboration includes a scientist from the National Climate Data Center (NCDC), who joined the NOAA NESDIS employees stationed at CIMSS.

CIMSS continues to excel at meeting the three components of its mission statement. We will briefly describe examples relevant to NOAA that demonstrate how CIMSS scientists, in collaboration with ASPB, are meeting our mission goals. Details on individual projects are provided later in the report; here we only refer to a few relevant examples.

### **1. Foster collaborative research between NOAA and UW-Madison in those aspects of atmospheric and earth science which exploit the use of satellite technology.**

The first element of the CIMSS mission is to foster collaborative research. One metric of success is to quantify the number of collaborative publications in general, and those with NOAA employees in particular. CIMSS has published more than 50% of its peer reviewed papers with NOAA co-authors (see Appendix 3), indicating the strong collaborations between the two organizations. For NOAA, another assessment strategy that CIMSS is meeting its goals is our ability to work with NOAA in transferring research to NOAA operations. We have over two dozen research algorithms that have been moved from our research community at CIMSS to NOAA operations. CIMSS scientists continue to collaborate with ASPB scientists in assessing new and current satellite instruments. For example, The GOES-13 Sounder and Imager experienced increased noise heading into the weekend of 22 September 2012. On 23 September 2012 both instruments were eventually disabled and no longer disseminating data. GOES-14 was moved toward the GOES-East position and GOES-14 data were disseminated to users via GOES-13, running the GOES-East schedule. ASPB/CIMSS was active in verifying satellite schedules and suggested that Puerto Rico should be covered in the CONUS frames. As diagnostics with GOES-13 continued, the suggestion was made to send out GOES-13 data via GOES-14 so that





GOES-13 data could be analyzed after the Imager and Sounder were reactivated. This is what happened for two 24-hour tests; CIMSS/SSEC received the GOES-13 data via GOES-14, generated products, and shared the results with GOES scientists and engineers.

The CIMSS has a long collaboration with ASPB in developing analysis methods for the GOES Sounder. CIMSS/ASPB worked with NOAA/NESDIS/Office of Satellite Products and Operations (OSPO) to update the GOES Sounder retrieval algorithm. These products are used operationally and flow into the NWS AWIPS. This collaboration demonstrates how the research to operations bridge can be crossed. This research-to-operations process, and accompanying product quality evaluation were accomplished by a collaborative effort among several organizations: CIMSS for algorithm development, assessment, and initial implementation; the NESDIS Center for SaTellite Applications and Research (STAR) and NESDIS OSPO for implementation within the operational environment; and the Office of Atmospheric Research (OAR) Earth Systems Research Laboratory (ESRL) for assessment with Global Positioning System (GPS)-Met co-located measurements.

GOES-14 1-minute Super Rapid Scan images occurred daily between mid-August and September 24th and late October 2012 (including Super Storm Sandy). The animations went “viral,” especially when the images were re-cast and posted on the NASA Earth Observatory page, where the YouTube videos were watched approximately a million times. We worked directly with the satellite operators to acquire the data over different locations. Many phenomena were observed: convection, hurricanes, fires, smoke, etc. These data are unique and will be used for years to better prepare for the mesoscale mode of the next generation advanced imager. For more information see:

<http://stratus.ssec.wisc.edu/aspb/weeklies/archive/12/11-02/>  
[http://cimss.ssec.wisc.edu/goes/srsor/GOES-14\\_SRSOR.html](http://cimss.ssec.wisc.edu/goes/srsor/GOES-14_SRSOR.html)

We have very long term collaborations with NOAA developing GOES imager and sounder products. In particular, CIMSS has been involved since the initiation of the NOAA GIMPAP (GOES Improved Measurements and Product Assurance Program) and continues to make important contributions to this program. GIMPAP supported projects have demonstrated that quantitative GOES satellite derived cloud properties are very valuable for predicting the short-term behavior of convective storms. An improved UW- Cloud Top Cooling (UWCI/CTC) algorithm is current being validated. The initial results indicate improved skill when validating against a variety of weather radar fields (e.g., reflectivity, radar estimated hail size, vertically integrated liquid). The improved UW-CTC algorithm output continues to be processed in real-time and is available to National Weather Service Weather Forecast Offices and National Weather Service Experiments/Testbeds, including the NOAA Hazardous Weather Testbed.

CIMSS scientists have a long and positive working relationship with NOAA on deriving GOES Atmospheric Motion Vectors (AMV). Although AMVs have had positive impacts on NWP, the representative vector heights have proven to be a relatively large source of observation uncertainty. Problems in data assimilation of AMVs can arise from the difficulty in accurately placing the height of the tracer. Thus, CIMSS is taking a fresh look at developing a specific quality indicator for AMV height assignment and validating this against collocated CALIOP observations.

CIMSS also has a strong partnership with NOAA in the GOES-R program. CIMSS scientists are producing high quality proxy ABI data sets derived from NWP model simulations for many GOES-R activities and teams, including the GOES-R Proving Ground Program, the Algorithm



Integration Team (AIT), the GRAFIIR, and the AWG Sounding, Winds, Clouds, Aviation, and Imagery/Visualization teams. The aerosol and ozone proxy data sets are generated with WRF-CHEM air quality simulations coupled to global chemical and aerosol analyses from the Real-time Air Quality Modeling System (RAQMS). Applications have included testing and evaluating AWG team algorithms, supplying data for responding to instrument waivers put forth by the GOES-R instrument vendors, and providing data to help train weather forecasters on the capabilities of ABI observations. CIMSS also assists NOAA when they respond to proposed changes in ABI instrument specifications. We help assess the potential effects on products and ABI waiver analysis when requested. The primary diagnostic tool, called Glance, was expanded and improved throughout the past year, and updates are provided to the AWG's Algorithm Integration Team (AIT). This GRAFIIR team continues to consult with the Integrated Modeling Working Group (IMWG) on behalf of the AWG. Additional examples of GOES-R activities at CIMSS in collaboration with NOAA include:

- During the past year CIMSS has focused on developing validation capabilities for GOES-R Advanced Baseline Imager (ABI) aerosol and cloud retrievals using airborne and surface measurements from the University of Wisconsin Autonomous High Spectral Resolution Lidar (AHSRL) under support from the GOES-R Program Office. Validation of the GOES-R AWG Cloud Height Algorithm (ACHA) and aerosol optical depth (AOD) algorithms using the Norman, OK AHSRL show that both retrievals are within the specification placed on the GOES-R algorithms. The ABI cloud retrieval was provided by the GOES-R Cloud Algorithm Working Group (AWG) using GOES-13 radiances and the ABI aerosol retrieval was provided by the GOES-R Aerosol AWG using MODIS Aqua radiances. The AHSRL airborne and surface validation tools and procedures developed using MODIS and GOES proxy measurements provide the foundation for post-launch ABI validation activities.
- The winds team conducted an evaluation of the GOES-R AMVs assimilation statistics from two short Global Forecast System (GFS) simulations during two different seasons. The usefulness of assimilating the GOES-R proxy AMVs within the GFS was confirmed and feedback has been provided to the algorithm development team as well as determining that adjustments to current geostationary AMV quality control.
- The CIMSS Advanced Dvorak Technique (ADT, Velden and Olander 2007) was selected to be the operational Hurricane Intensity Estimation (HIE) algorithm to operate within the GOES-R framework. The HIE will provide tropical cyclone (TC) intensity estimates using the GOES-R Advanced Baseline Imager (ABI) infrared imagery. The ADT was selected due to its longstanding use at several operational TC centers worldwide, and because of its proven record for accuracy and reliability in providing TC intensity estimates, especially where aircraft reconnaissance is not available.
- At CIMSS, the GOES-R ABI legacy atmospheric profile (LAP) algorithm has been developed under the GOES-R Algorithm Working Group (AWG) program, and the algorithm has been delivered for pre-operation implementation. The main focus now is the validation of the GOES-R LAP product with SEVIRI, the current GOES Sounder and the Moderate Resolution Imaging Spectroradiometer (MODIS) IR radiance measurements as proxy for GOES-R ABI, because of the spectral similarity between ABI and those instruments.
- CIMSS researchers are adapting the current GOES Wildfire Automated Biomass Burning Algorithm (WFABBA) to GOES-R ABI, building on our historical and current expertise in fire detection algorithm development for the GOES Imager and the global geostationary fire observation network. The revised WFABBA will address GOES-R ABI observational requirements.



- CIMSS participates and supports the GOES-R Proving Ground. The proving ground concept allows developers at CIMSS and other research centers to be involved at an early stage in product development with forecasters, providing the opportunity for interaction between developers and users. The proving ground activities include supporting multiple NOAA testbeds and Proving Ground demonstrations including the Hazardous Weather Testbed at the National Weather Center, the National Hurricane Center (NHC) PG demonstration, the Aviation Weather Testbed at the Aviation Weather Center (AWC), the NWS Training Center Testbed, the High Latitude PG demonstration at the Alaska Aviation Weather Unit, Satellite Applications Branch (SAB)/Ocean Prediction Center (OPC)/Hydrometeorological Prediction Center (HPC) PG demonstration, and Pacific Region PG demonstration.

Satellite-based volcanic ash products developed by scientists at the NOAA Center for Satellite Applications and Research (STAR) and the CIMSS are being used to improve operational volcanic ash advisories issued by Volcanic Ash Advisories Centers (VAACs) in the United States. The NOAA/STAR – CIMSS volcanic ash products provide users with critical information on ash cloud height, loading, and horizontal extent. For example, the NOAA/STAR – CIMSS volcanic ash products were utilized by the Washington VAAC to determine when a volcanic ash cloud from Mount Ruiz (Columbia) dissipated on May 29, 2012 (<http://www.ssd.noaa.gov/VAAC/ARCH12/RUIZ/2012E291926.html>). This algorithm is being transitioned to GOES-R.

CIMSS is heavily engaged with NOAA's ASPB in GOES-R and JPSS decision support satellite-based proving ground testing activities within demonstrations at eight NOAA National Centers and dozens of NOAA NWS Weather Forecast Offices. Between 2009 and 2013, new GOES-R proxy cloud properties, cloud low cloud/fog, convective cloud top cooling, fire, hurricane intensity estimate, icing, and convective over-shooting top detection information has been transmitted in near real-time to help guide products toward optimal use by NWS operations. Once the satellite-based decision support algorithms have been incrementally matured using the PG process, algorithms will then transition to operations.

## **2. Serve as a center at which scientists and engineers working on problems of mutual interest may focus on satellite related research in atmospheric studies and earth science.**

CIMSS and ASPB scientists continue to work side-by-side in assessing satellite instrument calibrations. CIMSS is active in the international effort to calibrate the world's environmental satellites: the Global Space-based Intercalibration System (GSICS). The primary goal of GSICS is to improve the use of space-based global observations for weather, climate and environmental applications through operational inter-calibration of the space component of the WMO Global Observing System (GOS) and Global Earth Observing System of Systems (GEOSS). CIMSS is an active partner with NOAA on this endeavor and much of the methodology developed at CIMSS was adopted by the international GSICS team. Through collaboration with the GSICS team, CIMSS is using AIRS to intercalibrate the GOES, Meteosat, FY-2, and MTSAT Imagers using the NESDIS GSICS algorithm retrospectively for the entire period of data record overlap between AIRS and these geostationary imagers. All of the data for the GOES Imagers has been delivered to NESDIS. Comparisons with METEOSAT-9 and METEOSAT-7 have been completed and delivered to NESDIS as well.



Sensor to sensor calibration differences continue to be studied in collaboration with the STAR calibration team. The hyper-spectral measurements from the Infrared Atmospheric Sounding Interferometer (IASI) on the MetOp satellite are used to simulate HIRS observations and to estimate the parameters in the linear models. The approach is to estimate radiance changes for a specific channel due to Spectral Response Function (SRF) modifications and related uncertainty. The linear models are applied to the NOAA and MetOp HIRS data at Simultaneous Nadir Overpass (SNO) locations to estimate the inter-satellite radiance differences. The inter-satellite mean radiance biases are minimized with residual maximum uncertainty less than 1% after the impacts of SRF differences and uncertainties are taken out. With use of the MetOp HIRS as a reference, the optimized SRFs for every NOAA HIRS instrument are found by minimizing the root-mean-square values of inter-satellite radiance difference. These recalibrated HIRS radiance measurements will be reprocessed using algorithms for cloud top properties (cloud amount, cloud top pressure, and associated error structures) and clear sky water vapor products (total precipitable water, TPW, and upper tropospheric humidity, UTH) that have been advanced in recent studies with the MODIS (Moderate resolution Imaging Spectroradiometer). Results from SNO recalibration will be compared with AIRS-IASI recalibration where possible. It has been found that relatively small changes in the HIRS radiances can translate into large differences in the cloud and water vapor products.

CIMSS continues to support NOAA's goal for infrared sounding data assimilation. We are working with personnel from the Atmospheric Infrared Sounder (AIRS) Science Team, the National Center for Environmental Prediction (NCEP), the National Environmental Satellite, Data and Information Service (NESDIS) and others in developing techniques to assimilate AIRS and the Infrared Atmospheric Sounding Interferometer (IASI) water vapor radiances.

In addition to supporting the next generation geostationary weather satellite, CIMSS scientists work closely with the NOAA/ASPB scientists to support the next generation polar satellite programs. The Joint Polar Satellite System (JPSS) is the successor to NOAA's Polar Orbiting Environmental Satellite series. SSEC/CIMSS has proposed to support a broad scope of activities aimed at providing the government with expertise in specific technical areas related to the JPSS mission. The general purpose of this work is to provide expertise that reduces schedule, cost, and performance risk, helps assess performance of industry, and points to feasible observing system improvements.

The first JPSS satellite, the Suomi NPP (National Polar Partnership), contains the Visible/Infrared Imager and Radiometer Suite (VIIRS) instrument. CIMSS personnel are collaborating with NOAA, CIRA, and Northrop Grumman, to create a suite of high quality satellite derived products. Working with NOAA scientists, CIMSS has created a local capability to execute algorithms that ingest VIIRS raw data, calibrate the data and produce various products, such as cloud presence, cloud water phase, cloud top height, cloud base height, and cloud water optical depth. Working with STAR leadership, tools were developed to plot global composites of that VIIRS Cloud Mask (VCM), validate them with the other cloud mask algorithm products (such as NOAA PATMOS-x, MODIS C5 and C6) and compare the performance of the VCM over all regions. This analysis helps to identify large scale errors and differences between the VIIRS and MODIS cloud masks. These tools are capable of processing large amounts of data and the comparison is accomplished by leveraging the processing capabilities of the NASA Atmospheric Product Evaluation And Test Element (PEATE) and the JPSS Algorithm Integration Team. The JPSS AIT at UW supports the NOAA JPSS AIT toward the goal of implementing pseudo-operational product generation, validation, and visualization capabilities for Suomi-NPP and follow-on polar satellites.



CIMSS scientists also work with the CrIS data on the Suomi-NPP. For example, VIIRS does not have any spectral bands located in H<sub>2</sub>O or CO<sub>2</sub> absorption bands, which degrades its ability to determine semi-transparent cloud properties. So, in addition to deriving cloud heights from VIIRS, the NPP CrIS hyperspectral IR sensor is used to generate accurate cloud heights for cirrus clouds, though at a lower spatial resolution. UW has also played a major role in various post-launch CrIS SDR (Sensor Data Records) cal/val tasks.

CIMSS scientists are recognized for their work in applying satellite observations to address aviation interests. Convectively induced turbulence (CIT), icing and lightning are all potential in-flight aviation hazards that require aircraft to avoid thunderstorms in order to mitigate the risk of passenger injury and/or aircraft damage. Research continues to refine relationships between GOES-R convective intensity metrics (lightning, IR, visible) and the occurrence of Convectively Induced Turbulence (CIT) in varied environments. In addition, work has been done to determine the predictability of CIT in the region of cloud-top cooling (CTC) events. The co-evolution of total-lightning, radar-derived fields, and GOES-14 1-minute SRSO observations and overshooting top (OT) detections were analyzed for two individual long-lived and severe convective storm cells. The analysis showed that rapid GOES IR cloud-top cooling (CTC) was well correlated with a rapid increase in total lightning flash rates in both storms. OTs were repeatedly detected while the storms were producing lightning and severe weather and discontinuation of OT detections signaled storm decay.

CIMSS scientists work collaboratively with ASPB scientists to develop global data sets of cloud amount and cloud properties from the Advanced Very High Resolution Radiometer (AVHRR) processing system, this research builds off the successful Pathfinder Atmospheres Extended (PATMOS-x) project data set, which recently delivered 30 years of cloud climate records from NOAA's POES Imager (AVHRR) to NOAA's National Climatic Data Center (NCDC). ASPB/CIMSS scientists have been active participants in international efforts of GEWEX to assess the capabilities of these polar orbiting satellites to define global cloudiness.

CIMSS scientists, working closely with ASPB scientists, also study the cryosphere with satellite observations, particularly in support of NPP VIIRS Snow and Ice EDRs (sea ice characterization, ice surface temperature, and snow cover/depth.). For example, the estimation of sea ice thickness is made using a One-dimensional Thermodynamic Ice Model (OTIM) with satellite-derived forcing fields. A suite of AMSR2 algorithms is being developed for the retrieval of snow cover and snow depth using AMSR-E data as a proxy using established methods.

As a final example of cross institute collaborations, CIMSS and ASPB scientists work with colleagues at NOAA/NESDIS, the University of Colorado, and the NASA Goddard Space Flight Center. CIMSS/ASPB, as part of a Cryosphere Product Development Team, is providing coordination for the generation, validation, and archival of fundamental and thematic snow and ice climate data records (FCDR and TCDR) that the scientific community can use to help answer the questions about a changing global climate.

CIMSS sponsored many national and international visitors during this time (Appendix 5). International visitors came from a wide array of countries, including Nario Kamekawas from the Japanese Meteorological Administration, Katja Hungershofer from Deutscher Wetterdienst, Andrzej Kotarba from the Space Research Centre of Polish Academy, Rodney Potts from the Centre for Australian Weather and Climate Research, Augusto Brandão d' Oliveira, CPTEC/INPE



in Brazil, Philip Frost from the Meraka Institute in South Africa and Wenguang Bai visiting from the China Meteorological Administration's National Satellite Meteorological Center.

### **3. Stimulate the training of scientists and engineers in those disciplines comprising the atmospheric and earth sciences.**

CIMSS continues to support NOAA's education goals. These activities span the landscape of education involving participation in K-12, undergraduate, graduate and professional training. To improve coordination of these activities we established the CIMSS Education and Public Outreach Office. CIMSS EPO is committed to promoting satellite meteorology resources and advancing weather and climate literacy. Above all, the new CIMSS Education and Public Outreach Office will strive to maintain excellence in education and outreach while working to ensure that CIMSS research products continue to provide maximum benefits to society.

NOAA and NASA grants support CIMSS graduate students in the UW-Madison Department of Atmospheric and Oceanic Sciences (see Appendix 5). The strong link between education and research at CIMSS provides an excellent path for young scientists entering careers in geophysical fields. Many of our former graduate students are now working for public and private industries to support NOAA activities.

CIMSS scientists work in collaboration with NOAA and other cooperative institutes in developing training resources for NOAA. The CIMSS involvement in the Virtual Institute for Satellite Integration Training (VISIT) program has involved research, development, and demonstration of new distance learning techniques and materials to address the utilization and integration of advanced meteorological data sources. In the past year we continued to create VISITview distance learning modules for a broad satellite meteorology audience, providing valuable satellite imagery interpretation materials that can be used in education and training, and also on maintenance and updates to existing satellite image lesson material. Forty-four "live" instructor-led VISITview teletraining sessions were given to a total of 58 NWS forecasters during this period, on eight topics. These lessons – and others – are also available for NWS staff to access via the US Department of Commerce Learning Center (CLC).

The presence of fully-functioning Advanced Weather Interactive Processing System (AWIPS I and AWIPS II) workstations at CIMSS allows for faster development of new educational materials that address these types of satellite interpretation topics (and also facilitates more frequent updates to pre-existing modules) as new case study examples are observed on a daily basis. This real-time AWIPS capability gives CIMSS the unique ability to present these satellite interpretation topics in a context and format that the National Weather Service (NWS) forecaster is familiar with. The Weather Event Simulator (WES) is an AWIPS training format that is widely used by NWS forecast offices. A pair of WES cases using simulated Advanced Baseline Imager (ABI) data have been developed at CIMSS as part of the GOES-R Proving Ground effort. New WES cases were developed for training NWS operational forecasters within their offices before participation in 2012 Hazardous Weather Testbed (HWT); specifically WES cases were developed for Cloud-Top-Cooling, Nearcasting, and Synthetic Imagery products. CIMSS remains committed to assuring a smooth transition of all CIMSS research to operations products from the existing AWIPS software to the upcoming AWIPS-II.

CIMSS contributed individual lessons that comprised the SHyMet Intern track, the SHyMet for Forecasters track, and the SHyMet: Severe Thunderstorm Forecasting track that comprise the overall SHyMet course. During the 01 April 2012 to 31 March 2013 period, 51 forecasters signed



up for these three particular SHyMet course tracks, with 30 forecasters successfully completing all the training material. Members of the CIMSS SHyMet team continued to participate in monthly VISIT/SHyMet teleconference calls, which were important to help in the identification and prioritization of new satellite training topics

Building on the success of the polar products in AWIPS work at CIMSS, the JPSS High Latitude Proving Ground aims to provide NPP/JPSS products to the National Weather Service as a means to improve local forecasts. CIMSS has completed initial testing of a training tool using data overpasses from the Suomi NPP Atmospheres Product Evaluation and Test Element (PEATE) covering Alaska. The data quality is very high and displays nicely in AWIPS using the CIMSS created AWIPS menus and enhancements. Future collaborations with Alaska are planned.

CIMSS continues to demonstrate learning the value of satellite observations using real time weather analysis distributed through the CIMSS Satellite Blog [<http://cimss.ssec.wisc.edu/goes/blog>]. The CIMSS Satellite Blog continues to serve as an expanding, searchable library of satellite products and meteorological case studies that can be used in future VISIT teletraining modules. During this past year, 190 new posts were added to the CIMSS Satellite blog. The CIMSS Satellite Blog also acts as an important source of “Just-In-Time” satellite training material for weather events that have recently occurred (or for important changes in operational satellites or satellite products).

CIMSS supported the expanding use of satellite-based weather products through positioning a CIMSS satellite scientist at the National Weather Service Training (NWS) Center and another at the Aviation Weather Center (AWC) in Kansas City, MO. The CIMSS scientists will provide leadership, satellite expertise, and meteorological support for the GOES-R Proving Ground efforts based at the NWS Training Center (NWSTC).

CIMSS is also active in outreach activities. CIMSS researchers are very active in NOAA’s Science on a Sphere (SOS) education program, both locally and nationally. The Aldo Leopold Nature Center has a SOS and we provide data and docent services to that organization to reach various public and school audiences. CIMSS writes the EarthNow blog (<http://sphere.ssec.wisc.edu/>), a resource for SOS docents, that develops and hosts datasets to explain recent weather and climate events, including connections to global climate change.

CIMSS also supports K-12 education. We continue to distribute our popular CDs on Satellite Applications for Geoscience Education and Satellite Meteorology for Grades 7-12 at various education focused conferences. CIMSS continues to offer a summer workshop through ESIP for science teachers that focus on the topics of satellite remote sensing, climate literacy and climate change. CIMSS supported the 2012 ESIP Teacher Workshop in Madison, Wisconsin where the new SatCam App was also presented to teachers in attendance and a new technology lending library was launched where teachers were able to borrow a CIMSS iPad, like a book, for the entire school year.

The stories above are but a few examples of how CIMSS worked with NOAA this year to achieve our mission goals. Details of these and additional projects follow. These events are shared among ourselves through this report, conference presentations, a building wide poster session and our CIMSS Science Symposiums.



## II. Background Information on the Cooperative Institute for Meteorological Satellite Studies (CIMSS)

### 1. Description of CIMSS, including research themes, vision statement and NOAA research collaborations

The Cooperative Institute for Meteorological Satellite Studies (CIMSS) was formed through a Memorandum of Understanding between the University of Wisconsin–Madison (UW–Madison) and the National Oceanic and Atmospheric Administration (NOAA). The CIMSS formal agreement with NOAA began in 1980 and was continued through a competitive review process in 2010. The CIMSS mission includes three goals:

- Foster collaborative research among NOAA, NASA, and the University in those aspects of atmospheric and earth system science that exploit the use of satellite technology;
- Serve as a center at which scientists and engineers working on problems of mutual interest can focus on satellite-related research in atmospheric and earth system science;
- Stimulate the training of scientists and engineers in the disciplines involved in atmospheric and earth sciences.

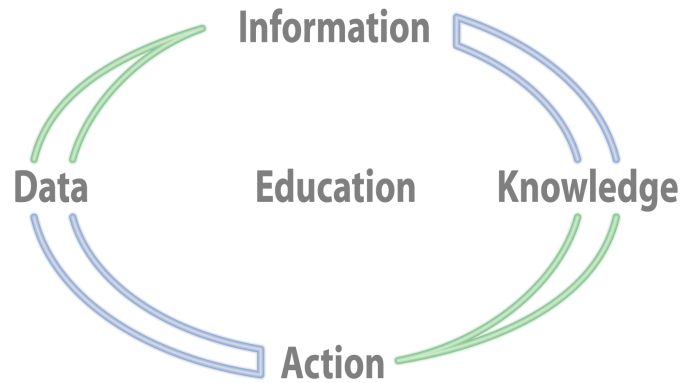
To achieve these mission goals CIMSS conducts a broad array of research and education activities, many of which are projects funded through this Cooperative Agreement with NOAA. This Cooperative Agreement identifies four CIMSS themes, three science research themes and one outreach theme:

1. Satellite Meteorology Research and Applications
2. Satellite Sensors and Techniques
3. Environmental Models and Data Assimilation
4. Education and Outreach

The collaborative relationship between NOAA and the UW-Madison which led to the establishment of CIMSS has provided outstanding benefits to the atmospheric science community and to the nation through improved use of remote sensing measurements for weather forecasting, climate analysis and environmental issues. CIMSS research investigations increase understanding of remote sensing and its numerous applications to weather and nowcasting/forecasting, clouds, aerosols and radiation, the global hydrological cycle, environmental trends, and climate, as well as education and outreach.

CIMSS scientists are engaged in a broad array of research activities ranging from using GOES measurements to estimate the intensity of Atlantic basin hurricanes to designing tools to analyze observations from the next generation satellite instruments. Our research process is represented in the figure below. Algorithms are developed and applied to observations (data) to yield information about Earth. We apply this information to gain knowledge about the Earth system, knowledge that can be utilized in decision-making processes. As we rely on this knowledge to take action we demonstrate the need for better observations, and work with our partners, particularly those in SSEC, in designing and testing improved instrumentation. At the center of this research process is education - the training of students, professionals and ourselves.





CIMSS conducts a broad array of activities that engages researchers and students in a variety of research and education endeavors.

CIMSS plays a unique role to NOAA as a non-profit partner, advisor, consultant and link to UW-Madison students and researchers. As a long-term partner of NOAA, CIMSS helps to serve as part of the NESDIS corporate memory, particularly when government staff change positions and roles. For example, original CIMSS/SSEC staff associated with GOES VAS (the first geostationary sounding instrument) and GOES-8/14 design, testing, and checkout are now assisting with similar activities in GOES-R. On the polar orbiting satellite side, our decades long work with the TOVS and ATOVS sounders and the aircraft HIS (High spectral resolution Interferometer Sounder) and scanning-HIS aided in the development of applications for the CrIS (Cross-track Infrared Sounder) hyperspectral sounder on Joint Polar Satellite System (JPSS). In addition to bringing “corporate memory” to these new GOES and JPSS programs, the senior staff help to train the next generation of CIMSS scientists who will support future partnerships between CIMSS and NOAA.

CIMSS scientists work side-by-side with the NESDIS/STAR/ASPB (Advanced Satellite Products Branch) scientists who are stationed at the University of Wisconsin-Madison. Being collocated in the same building and having similar research interests fosters powerful ties and collaborations. In addition to working with CIMSS scientists, ASPB scientists often mentor graduate students on research projects. These research projects address NOAA needs while helping to satisfy UW-Madison degree requirements. Based on this positive experience, some of these students go on to work with NOAA and supporting contractors. The National Climate Data Center (NCDC) has stationed a research scientist at CIMSS to further build collaborations. CIMSS plans to leverage this collaboration by providing expertise in using satellite data sets for climate studies. CIMSS and ASPB scientists have developed satellite data sets for climate studies including, a HIRS/2 cloud climatology data set, the PATMOS-X AVHRR data set, an AVHRR polar applications data set, and a GOES cloud properties data set. The polar orbiting satellite data sets extend back more than 30 years.

CIMSS maintains a close collaboration with the NOAA Office of Systems Development (OSD) as part of the NOAA support team for the future GOES-R ground system development systems. CIMSS also interacts with the Office of Satellite Products and Operations (OSPO) in the transfer of research techniques and algorithms developed at CIMSS in collaboration with ASPB, to NOAA operations. Nearly two dozen research algorithms developed at CIMSS have been utilized by NESDIS operations. Through specific research projects, CIMSS has a strong research collaboration with the JPSS, supporting the instrument design and algorithms of the next generation operational imager and sounder on polar satellites.



Within the NOAA National Weather Service (NWS), CIMSS collaborates on data assimilation projects with the National Centers for Environmental Prediction Environmental Monitoring Center (NCEP/EMC). The CIMSS tropical cyclone research team maintains close collaboration on new products development with the Tropical Prediction Center (NCEP/TPC) in Miami. CIMSS works with the Storm Prediction Center (NCEP/SPC) in Norman, OK on satellite applications to severe weather analysis and forecasting. CIMSS collaborates with the Aviation Weather Center (NCEP/AWC) in Kansas City on aviation safety projects that utilize weather satellite data. CIMSS scientists are involved with local NWS offices on specific projects, and maintain close ties with NWSFOs in Milwaukee/Sullivan, La Crosse and Green Bay. Finally, CIMSS works with CIRA and the COMET office through the NWS Training Center to participate in the VISIT and SHyMet programs.

## 2. CIMSS Management and Administration

CIMSS resides as an integral part of the UW-Madison Space Science and Engineering Center (SSEC). CIMSS is led by its Director, Dr. Steven Ackerman, who is also a faculty member within the UW-Madison Department of Atmospheric and Oceanic Sciences. Associate Director Wayne Feltz, with assistance from SSEC Science Director Thomas Achtor, provide day-to-day oversight of the CIMSS staff, science programs, and facilities. The individual science projects are led by University Principal Investigators (PIs) in conjunction with a strong and diverse support staff who provide additional expertise to the research programs. CIMSS is advised by a Board of Directors and a Science Advisory Council (Section II. 4 below).

The CIMSS administrative home is within the Space Science and Engineering Center (SSEC), a research and development center within the UW–Madison’s Graduate School. The SSEC mission focuses on geophysical research and technology to enhance understanding of the Earth, other planets in the Solar System, and the cosmos. To conduct its science mission on the UW-Madison campus, SSEC has developed a strong administrative and programmatic infrastructure. This infrastructure serves all SSEC/CIMSS staff.

SSEC support infrastructure includes:

- **Administrative support**  
The administrative support team includes 14 full-time staff and several students providing services that include human relations, proposal processing and publishing, grant and contract management, accounting, financial programming, purchasing and travel.
- **Technical Computing**  
The technical computing support team includes 6 full-time staff and several students providing consultation and implementation on system design, networking infrastructure, and full support for Unix and pc computing.
- **Data Center**  
The SSEC Data Center provides access, maintenance, and distribution of real-time and archive weather and weather satellite data. The Data Center currently receives data from 10 geostationary and 8 polar orbiting weather satellites in real time and provides a critical resource to SSEC/CIMSS researchers.
- **Library**  
SSEC maintains an atmospheric science library as part of the UW–Madison library system. A full time librarian is on staff and two part time assistants.



- **Media and Communications**  
SSEC has created a Media Team that includes a full time media specialist, two web masters (for SSEC and CIMSS) and a design specialist to support the dissemination of information on scientist activities and research results and to develop in-house publications.
- **Visualization Tools**  
SSEC is a leader in developing visualization tools for analyzing geophysical data. The Man-computer Interactive Data Access System (McIDAS), Vis5D and VisAD software are used worldwide in a variety of research and operational environments. The VISITView software is used extensively as a tele-training tool by the NWS and others. To further support NOAA NWS forecast offices, CIMSS develops satellite products for AWIPS and AWIPS2, maintaining both systems within our facilities.

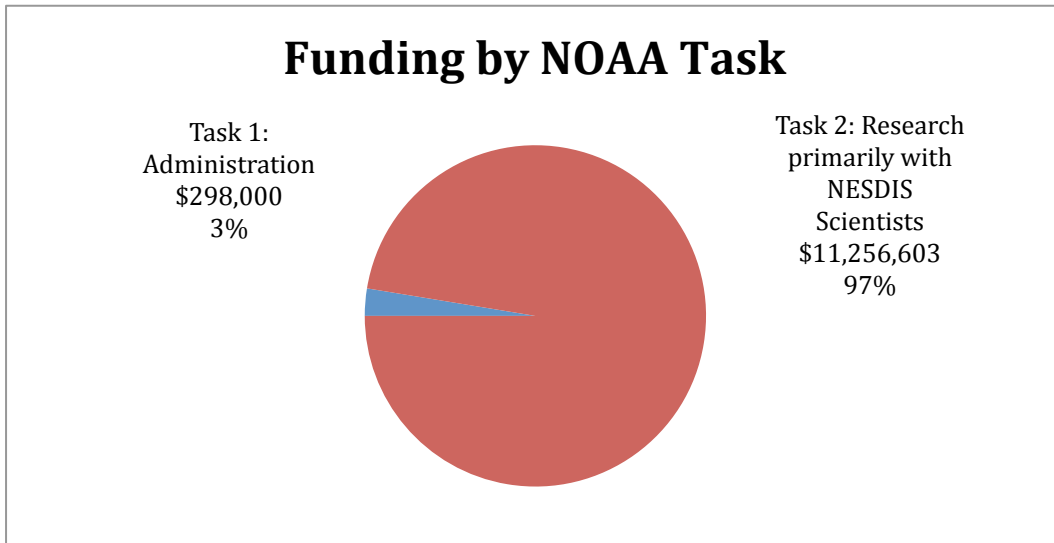
### **3. NOAA funding to CIMSS Cooperative Agreement NA10NES4400013 in FY2012 - summarized by Research Task, NOAA Strategic Goal and CIMSS Research and Education Themes**

In FY2012, funding to CIMSS through Cooperative Agreement NA10NES4400013 totaled \$11,554,603. FY2013 funding is not sufficiently known at this time to include in this report. The following tables and graphics show the distribution of these funds by Task, by NOAA Strategic Goal and by CIMSS Research and Outreach Theme. The total represents FY2012 funds provided to CIMSS under the Cooperative Agreement that began on 1 July 2010 and covers the 12 month period from 1 October 2011 to 30 September 2012.



### Funding by NOAA Task

CIMSS Task	Funding in dollars	Percentage
Task 1: Administration	\$ 298,000	3%
Task 2: Research primarily with NESDIS Scientists	\$ 11,256,603	97%
Task 3: Research with other NOAA Programs	\$ 0	0%
	\$11,554,603	

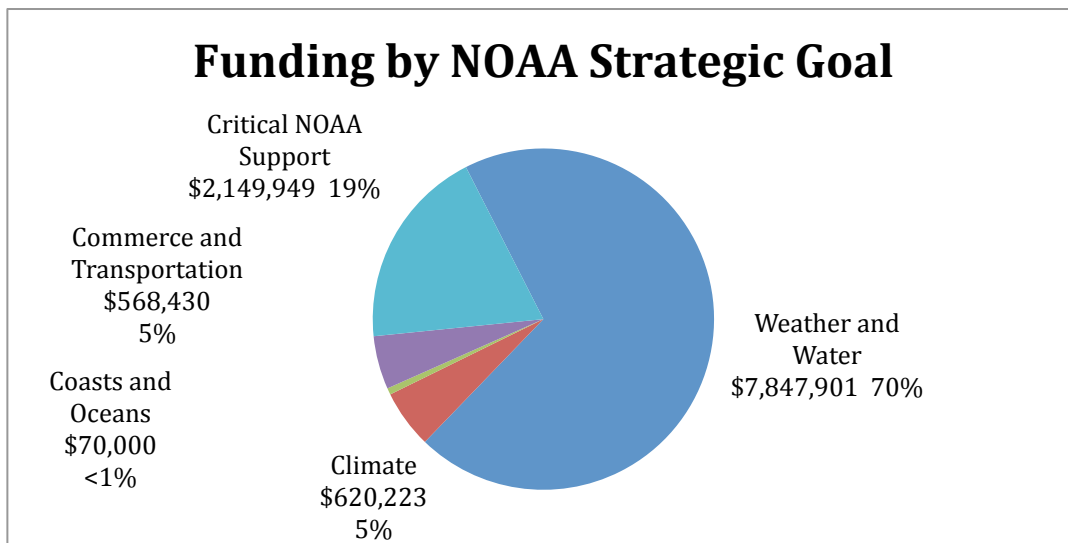




### Funding by NOAA Strategic Goal

NOAA Strategic Goal	Funding in dollars	Percentage
Weather and Water	\$7,847,901	70%
Climate	\$620,223	6%
Coasts and Oceans	\$70,000	<1%
Commerce and Transportation	\$ 568,430	5%
Critical NOAA Support	\$2,149,949	19%
	\$11,256,503*	

\* - does not include the Task 1 funding



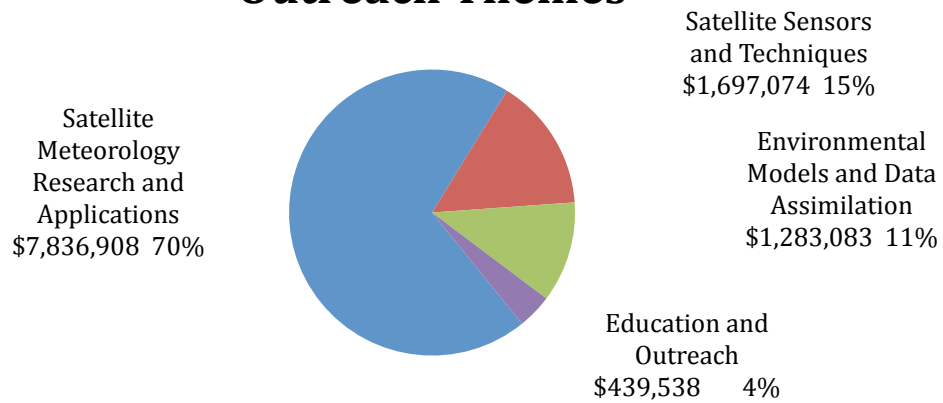


### Funding by CIMSS Research and Outreach Themes

CIMSS Theme	Funding in dollars	Percentage
Satellite Meteorology Research and Applications	\$7,836,908	69%
Satellite Sensors and Techniques	\$1,697,074	15%
Environmental Models and Data Assimilation	\$1,283,083	11%
Education and Outreach	\$ 439,538	4%
	\$11,256,503*	

\* - does not include the Task 1 funding

### Funding by CIMSS Research and Outreach Themes





## 4. Board and Council Membership

### CIMSS Board of Directors

The Board of Directors meets formally approximately once a year to review the policies, research themes, and priorities of CIMSS, including budget and scientific activities. The Board is also responsible for approving the appointment of members to the Science Advisory Council. The most recent Board of Directors meeting was held in June 2011. Current Board of Directors members include:

Martin Cadwallader, Chair	Dean, Graduate School, UW-Madison
Steven A. Ackerman	Director, CIMSS, UW-Madison
Henry E. Revercomb	Director, SSEC, UW-Madison
Jonathan Martin	Chair, Department of Atmospheric and Oceanic Sciences, UW-Madison
Mary Kicza	Assistant Administrator for Satellite & Information Services., NOAA/NESDIS
Alfred Powell	Director, Center for Satellite Applications and Research, NOAA/NESDIS
Jeff Key	Chief, Advanced Satellite Products Branch, NOAA/NESDIS
Jack Kaye	Associate Director for Research, NASA
Peter Hildebrand	Director, Earth-Sun Exploration Division of the Sciences and Exploration Directorate, NASA Goddard Space Flight Center
Lelia Vann	Director, Science Directorate, NASA Langley Research Center

### CIMSS Science Advisory Council

The Science Advisory Council advising the CIMSS Director in establishing the broad scientific content of CIMSS programs, promoting cooperation among CIMSS, NOAA, and NASA, maintaining high scientific and professional standards, and preparing reports of CIMSS activities. The Science Council normally meets every 1-2 years; however, the last Council meeting was held in November 2009. Science Council members include:

Allen Huang	Distinguished Scientist, CIMSS
Chris Velden	Senior Scientist, CIMSS
Trina McMahon	Professor, College of Engineering, UW-Madison
Annemarie Schneider	Professor, SAGE, UW-Madison,
Ralf Bennartz	Professor, Department of Atmospheric and Oceanic Sciences, UW-Madison
Christopher Kummerow	Professor, Department of Atmospheric Science, Colorado State University
Bob Ellingson	Professor, Department of Earth, Ocean, and Atmospheric Science, Florida State University
Steve Goodman	GOES-R Senior Scientist, GOES-R Program Office
Ingrid Guch	Chief, Atmospheric Research and Applications Division, NOAA/NESDIS/ORA
Pat Minnis	Senior Research Scientist, NASA Langley Research Center
Steve Platnick	Acting EOS Senior Project Scientist, NASA Goddard Space Flight Center



### III. Project Reports

#### 1. CIMSS Task 1A Support

**CIMSS Task Leaders: Steve Ackerman, Wayne Feltz, Tom Achtor**

**CIMSS Support: Maria Vasys, Leanne Avila, Wenhua Wu, Jenny Hackel**

**NOAA Strategic Goals**

- Provide critical support for the NOAA mission

**CIMSS Research Themes**

- Education and Outreach

**Proposed Work**

The CIMSS Task 1 funding supports activities related to CIMSS administration and non-research programs that are important to the workplace environment of CIMSS. Partial administrative support is provided for the CIMSS Director, Executive Director, the Program Assistant, and the CIMSS Webmaster. Task I activities also includes leveraging support for education and outreach projects, per diem support for visiting scientists, post doctoral positions and first year graduate students.

**Summary of Accomplishments and Findings**

The CIMSS Task I funds continue to support the administrative needs for the CIMSS Director, the CIMSS Associate Director and the CIMSS Staff. Program Assistant Maria Vasys provides that support and is also supported by student hourly employees to maintain a consistent presence in the CIMSS administrative office. SSEC administration provides the majority of administrative support for CIMSS contracting, accounting, purchases, human resources and travel at no cost to Task 1 funding.

Task I funding supports the development and updates of the CIMSS Web page (see <http://cimss.ssec.wisc.edu/>). The home page provides an innovative approach to the research pages by allowing users to access CIMSS research projects via three paths: alphabetically, by observing platform and by CIMSS research theme. The CIMSS Web page is closely linked to the NOAA ASPB Web site (<http://cimss.ssec.wisc.edu/aspb/>) and to the SSEC Web site (<http://www.ssec.wisc.edu>).

CIMSS has created the “NOAA-CIMSS Collaborative Award for developing NOAA’s Strategic Satellite Plan to balance requirements, observation capabilities, and resources.” These awards may be given to CIMSS scientists who have worked closely with NOAA scientists who have received a NOAA award. The CIMSS award is to recognize the partnership that occurs in research with ASPB and UW-Madison scientists.

#### 2. CIMSS Task 1B Support – Education and Outreach

**CIMSS Task Leaders: Margaret Mooney and Steve Ackerman**

**NOAA Long Term Goals**

- Climate Adaptation and Mitigation
- Weather-Ready Nation

**NOAA Strategic Goals**

- Serve society’s needs for weather and water





- Understand climate variability and change to enhance society's ability to plan and respond

### **CIMSS Research Themes**

- Education and Outreach

### **The New CIMSS Education and Public Outreach Office**

When NOAA established the Cooperative Institute for Meteorological Satellite Studies (CIMSS) in 1980 within the Space Science and Engineering Center (SSEC) at the University of Wisconsin-Madison, the location provided the perfect conduit to future generations of our scientific workforce. Since inception, CIMSS has supported NOAA and NASA sponsored student fellowships on an annual basis. In 1991 CIMSS established a summer workshop for high school students, one of the first in the country, further supporting the pipeline to college and careers. In 2002, CIMSS began offering workshops for science teachers around the topics of satellite remote sensing, climate literacy and climate change.

CIMSS has been a leader in educational software design for several decades, pioneering distance learning software and computer-based education tools while recently launching an innovative technology lending library for middle and high school science teachers. With so many programs and so many legacies, CIMSS recently decided to formally establish an Education and Public Outreach Office tapping Margaret Mooney to serve as the new Director. Mooney is a former National Weather Service (NWS) meteorologist and the last MIC (Meteorologist in Charge) of the Madison Weather Service Office. She is active in several education communities, both on and off the UW-Madison campus. As a certified GLOBE trainer and former NWS meteorologist, Mooney has decades of experience working with formal and informal audiences. She is the Education vice-chair of the Federation of Earth Science Information Partners (ESIP), a national community of science, data and information technology practitioners. More locally, Mooney serves on the outreach committee for the Wisconsin Initiative for Climate Change Impacts (WICCI). She also served on the White House Council on Environmental Quality (CEQ) roundtable on communicating climate change adaptation in 2010 and participated in 2013 Climate Science Day on Capitol Hill. In 2011 Mooney was Co-Investigator on a project to evaluate NOAA's Climate Services Web portal, [climate.gov](http://climate.gov). Through these broad-ranging endeavors, Mooney has developed a clear vision of the many ways that CIMSS education initiatives overlap and intertwine with NOAA and NASA education goals.

Integral to the success of the new CIMSS EPO office will be the addition of Patrick Rowley who joined CIMSS in 2011 to develop and write the CIMSS EarthNow blog (<http://sphere.ssec.wisc.edu/>), a resource for Science on a Sphere (SOS) docents that develops and hosts datasets to explain recent weather and climate events, including connections to global climate change.

Along with advancing weather and climate literacy, CIMSS EPO prioritizes satellite remote sensing awareness. On the UW-Madison campus this involves maintaining a 3D sphere similar but smaller than the SOS exhibits. On the Internet this involves resources for all levels of learners, ranging from the CIMSS Satellite Blog to Facebook to on-line curriculum supporting students and teachers. This also includes the new GOES-R Education Proving Ground, a CIMSS initiative involving middle and high school science teachers developing activities in preparation for the GOES-R launch.

Through national initiatives like AMS Weatherfest, ESIP meetings, SOS docent support and local events like student and teacher workshops, student fellowships and campus science fairs, CIMSS



EPO is committed to promoting satellite meteorology resources and advancing weather and climate literacy. Above all, the new CIMSS Education and Public Outreach Office will strive to maintain excellence in education and outreach while working to ensure that CIMSS research products continue to provide maximum benefits to society.

### **3. CIMSS Participation in the 2012 GOES Improved Measurements and Product Assurance Plan (GIMPAP)**

#### **3.1. Daytime Enhancement of UWCI/CTC Algorithm for Operation in Areas of Thin Cirrus**

**CIMSS Task Leader: Justin Sieglaff**

**CIMSS Support Scientists: Lee Crone, Wayne Feltz**

**NOAA Collaborator: Michael Pavolonis**

##### **NOAA Long Term Goals**

- Weather-Ready Nation

##### **NOAA Strategic Goals**

- Serve society's needs for weather and water
- Support the nation's commerce with information for safe, efficient and environmentally sound transportation
- Provide critical support for the NOAA mission

##### **CIMSS Research Themes**

- Satellite Meteorology Research and Applications
- Satellite Sensors and Techniques

##### **Proposed Work**

The University of Wisconsin Convective Initiation/Cloud Top Cooling (UWCI/CTC) algorithm was developed by previous GIMPAP funded projects. The UWCI/CTC algorithm is designed to identify vertically growing and hence cooling convective clouds in GOES imagery both day and night. The cloud-top cooling rates are combined with GOES Cloud Phase retrievals to make convective initiation nowcasts. Forecasters at various test beds have evaluated the UWCI/CTC output over the past 3 convective seasons. While feedback from forecasters was generally positive, the largest deficiency identified by forecasters was the algorithm design to not operate in areas of cirrus clouds, even thin cirrus clouds. This decision was made because a cooling brightness temperature in presence of two cloud layers (upper thin ice cloud and lower water cloud) can be ambiguous. (The ambiguous nature is because a cooling brightness temperature in these situations can be any combination of thickening upper level ice cloud and/or vertically growing lower water cloud.) To resolve this deficiency identified by forecasters we propose to allow UWCI/CTC to diagnose/nowcast cloud-top cooling/convective initiation of newly developing convection covered by thin cirrus clouds during daytime hours. Including and monitoring temporal trends of retrieved GOES cloud optical depth during daytime hours within the UWCI/CTC algorithm will achieve this goal.

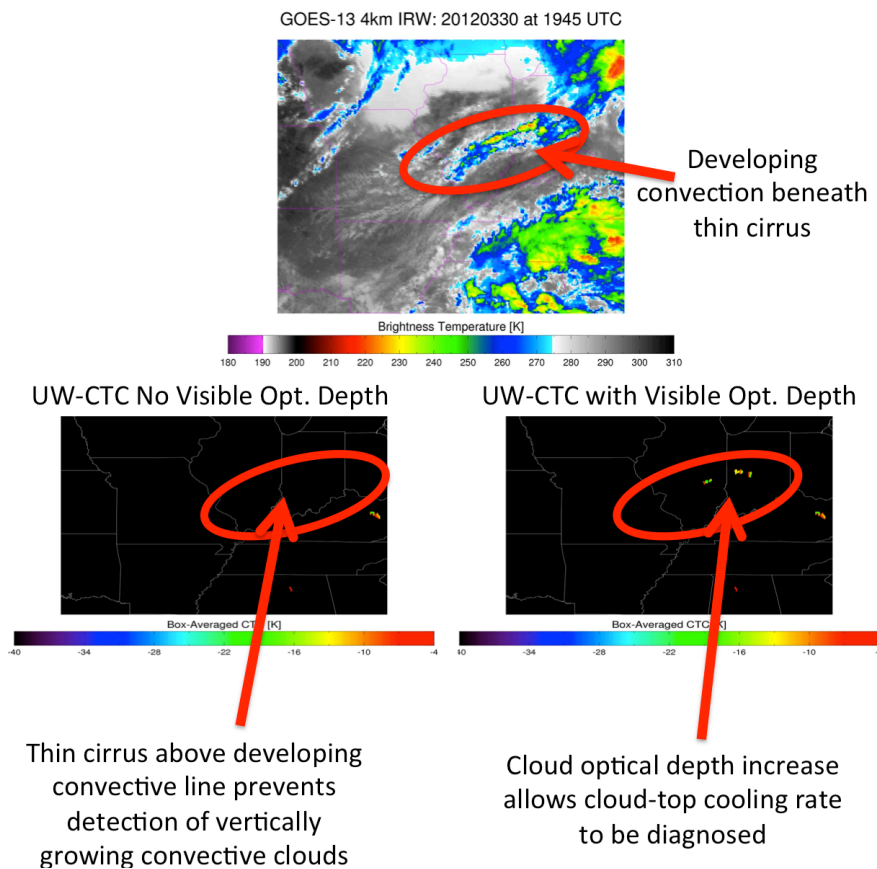
##### **Summary of Accomplishments and Findings**

During the past FY, the UWCI/CTC algorithm has been modified to include the latest GOES visible optical depth (VOD) retrieval output. The inclusion of the GOES VOD has enabled detection of vertically growing cumulus clouds in regions of thin cirrus clouds, eliminating a previously identified deficiency of the UWCI/CTC algorithm. Figure 3.1.1 shows an example of the output of the UWCI/CTC prior to inclusion of GOES VOD retrievals and after inclusion of



GOES VOD retrievals. The growing convection over eastern Illinois and western Indiana was largely missed in the original version of the UWCI/CTC algorithm (bottom left), but in the improved version is now successfully detected (bottom right).

The new version of the UWCI/CTC algorithm is being validated and compared to the output of the original algorithm version. The initial results indicate improved skill when validating against a variety of weather radar fields (e.g., reflectivity, radar estimated hail size, vertically integrated liquid). The validation efforts also revealed an additional unexpected improvement. In some cases the original UWCI/CTC algorithm missed the strongest vertical growth of a developing thunderstorm when the growth occurred *after* the cloud-top was sufficiently glaciated but the improved version more reliably detects these strongest periods of growth. The results of the validation study are being composed into a peer reviewed journal article (Sieglaff et al., 2013). The improved UWCI-CTC algorithm output continues to be processed in real-time and is available to National Weather Service Weather Forecast Offices and National Weather Service Experiments/Testbeds, including the NOAA Hazardous Weather Testbed.



**Figure 3.1.1.** Top panel is GOES-13 11  $\mu\text{m}$  brightness temperature valid at 1945 UTC 30 March 2012; developing convection beneath thin cirrus clouds is highlighted over eastern Illinois and central Indiana. Bottom left panel is UW-CTC output without visible optical depth and bottom right panel is UW-CTC output with visible optical depth both valid at 1932 UTC 30 March 2012. The addition of visible optical depth to the UWCI/CTC algorithm enables detection of these storms that were missed with the original version of the algorithm.



## Publications and Conference Reports

Sieglauff, J. M., L. M. Cronic, and W. F. Feltz, 2013: Improving satellite-based convective cloud growth monitoring with visible optical depth retrievals. *J. Appl. Meteor. Climatol.*, In preparation.

Sieglauff, J. M. L. M. Cronic, and W. F. Feltz, 2013: Using UW-Cloud Top Cooling Rates in Convective Storm Warning Experiments. *2<sup>nd</sup> National Weather Service Eastern Region Virtual Satellite Workshop*.

Sieglauff, J. M. L. M. Cronic, and W. F. Feltz, 2012: Using UW-Cloud Top Cooling Rates in Convective Storm Warning Experiments. *37<sup>th</sup> Natl. Wea. Assoc. Annual Meeting*, Madison, WI, Natl. Wea. Assoc.

## References

Pavolonis, M. J, 2010a: Advances in extracting cloud composition from spaceborne radiances: A robust alternative to brightness temperatures, Part I: Theory. *J. Appl. Meteor. Climatol.*, **49**, 1992-2012.

Sieglauff, J. M., L. M. Cronic, W. F. Feltz, K. M. Bedka, M. J. Pavolonis, and A. K. Heidinger, 2011: Nowcasting convective storm initiation using satellite-based box-averaged cloud-top cooling and cloud-type trends. *J. Appl. Meteor. Climatol.*, **50**, 110–126.

Walther, A., A. K. Heidinger, 2012: Implementation of the Daytime Cloud Optical and Microphysical Properties Algorithm (DCOMP) in PATMOS-x. *J. Appl. Meteor. Climatol.*, **51**, doi:10.1175/JAMC-D-11-0108.1.

## 3.2. Fusing GOES Observations and RUC Model Output for Improved Cloud Remote Sensing

**CIMSS Task Leader: Andi Walther**

**NOAA Collaborator: Andrew Heidinger**

### NOAA Long Term Goals

- Climate Adaptation and Mitigation
- Weather-Ready Nation

### NOAA Strategic Goals

- Serve society's needs for weather and water
- Understand climate variability and change to enhance society's ability to plan and respond
- Provide critical support for the NOAA mission

### CIMSS Research Themes

- Satellite Meteorology Research and Applications
- Satellite Sensors and Techniques

## Proposed Work

The GOES-R AWG cloud algorithms have been modified for and are running on current GOES data. Our validation indicates that these data are high quality and the results approach the expected GOES-R performance for many scenarios.

We are working with the RAP team to optimize the 3-d cloud hydrometeor distributions using the initial RAP analysis and the results (including the uncertainties) from the Optimal Estimation



(OE) cloud retrievals with the existing radar and METAR data. We are using CALIPSO and CloudSat data when possible for verification.

The RAP team will develop the techniques to use the GOES cloud properties and lead the efforts to ensure the satellite derived 3d hydrometeor fields are beneficial to the RUC/RAP. The Rapid Refresh (RAP) mesoscale model system replaced the RUC as an NCEP operational model in May 2012. The RAP uses a similar cloud/ hydrometeor analysis (within GSI) as the RUC, in which 3-d hydrometeor fields for cloud water and ice mixing ratios modified based on current METAR ceiling and GOES cloud retrieval data. The RAP is the only current NCE model/ assimilation system to use either GOES or METAR cloud data, making it one the leading NWP model in its use of cloud information from satellites. As part of the project, we will implement a real-time feed of GOES-R analog cloud products from CIMSS to the ESRL RAP team to allow for experimentation. The GOES-R AWG analog products used here generated using the NESDIS CLAVR-x system.

Currently, direct use of the cloud fields observed by satellites has been found to introduce significant high relative humidity (RH) biases relative to radiosonde verification. In this project, we are developing techniques that allow the Rapid Refresh (RAP) to use the GOES-R cloud products without inducing the RH biases.

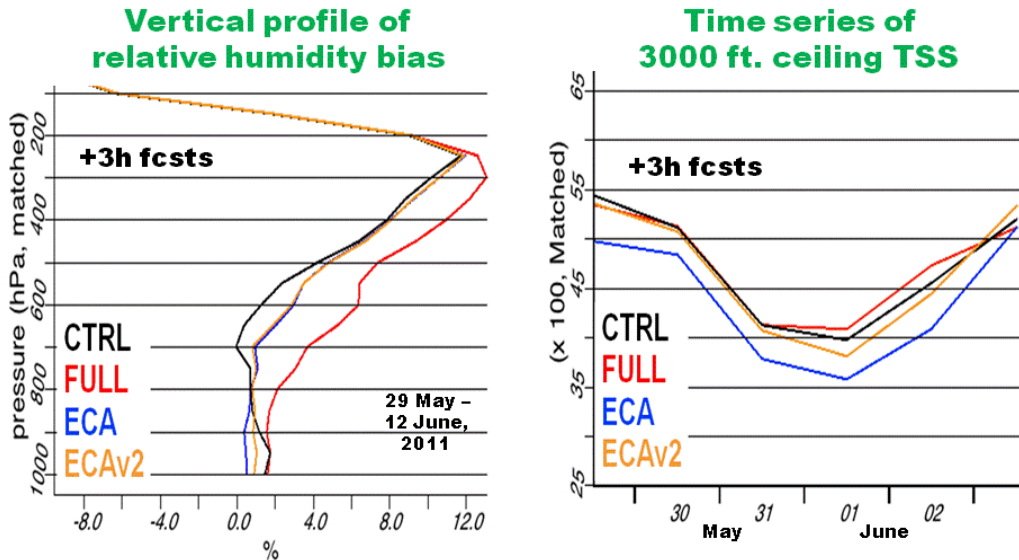
Some details on the issue and the work to resolve it are as follows:

- It was discovered in Dec 2010 that cloud building from NASA GOES cloud retrievals resulted in a significant RH moist bias and higher RH forecast error.
- To solve this, we further examined the cloud assimilation with the GOES-R AWG products and developed ways to use the retrieval uncertainties with the RUC/RAP background fields and improve mixed-phase saturation definition to reduce the RH biases.
- Recent work has focused on utilizing the GOES-R Effective Cloud Amount (ECA) field to perform more selective clearing and building of clouds

This project will lead to the greater use of GOES and GOES-R cloud products for NWP.

### **Summary of Accomplishments and Findings**

- Establish experimental feed of CLAVR-X data from CIMSS to ESRL.
- Write processing code for CLAVR-X data and code to convert data to BUFR and ingest it into GSI (Gridpoint Statistical Interpolation) data assimilation code used in NOAA overall and specifically with the RAP in a RAP-specific configuration.
- Conduct CLAVR-X data assessment, test assimilation of data for RAP cloud analysis.
- Use CLAVR-x Effective Cloud Amount (ECA) to more effectively build clouds without introducing a high bias in relative humidity.
- Test and evaluate overall CLAVR/ECA assimilation within the 13-km Rapid Refresh (RAP)
- Test and evaluate 3-km cloud assimilation capability.
- Experimental feed of CIMSS/STAR cloud properties setup at CIMSS and real-time data transfer established with ESRL GSD (ingest and processing software configured on ESRL side).



**CTRL:** Cloud building only below 1200m -- RAPv2 (used for all expts.)  
**FULL:** Full column building -- self calculated observed cloud fraction  
**ECA:** Full column building -- CLAVR-X with Effective Cloud Amount (ECA) -- clearing for ECA indicated partly cloudy regions  
**ECAv2:** ECA (full column building using CLAVR-X with ECA) -- no modification to background clouds for ECA indicated partly cloudy regions

**Figure 3.2.1.** Retrospective comparison of four experiments related to assimilation of the CLAVR-X satellite cloud data. Left panel – vertical profile of mean (over entire retrospective period) relative humidity bias (relative to radiosonde observations). Right panel – times series over ~ 5 day period from retrospective period of 3000 ft. ceiling true skill score (computed against METAR observations).

- Significant progress on 13km Rapid Refresh cloud assimilation:
  - Baseline testing completed confirming that full column cloud building introduces mid-level high moisture bias, while cloud building for GOES cloud top < 1200m AGL (above model ground level) does not introduce bias.
  - Generation of hypotheses and initial testing results indicate that use of 75% ECA threshold for clearing / building allows full-column cloud building without introducing moist bias (the target for our GIMPAP project), but associated skill degradation for ceiling analysis and forecasting occurs.
  - Refinement in use of ECA to allow separate level and threshold dependencies for clearing and building of clouds has yielded the desired results of full-column cloud building, without introducing high relative humidity bias and without degrading ceiling forecast skill, for a warm season RAP retrospective assessment. This is illustrated in Fig. 3.2.1, which show two different sets of error statistics for each of four CLAVR-X related RAP retrospective experiments. As can be seen in the relative humidity (RH) bias curves on the left, introduction of a simple full column cloud building produces a significant positive RH bias throughout much of the troposphere (red “FULL” curves relative to black “CTRL” curves). Introduction of a more selective building algorithm using the Effective Cloud Amount field of the CLAVR-X data reduces the positive RH bias, but also degrades the ceiling forecast skill (blue “ECA” curves relative to red “FULL” curves). Finally, modification of the algorithm to make no changes



to the background cloud hydrometeor fields (building or clearing) for regions with intermediate ECA values (indicating partly cloudy conditions) yields the desired results of a reduction in the high RH bias, with little degradation in the ceiling forecast skill (yellow “ECAv2” curves relative to all other curves).

- Preliminary testing of a related full-column GOES cloud building procedure using 3km HRRR background as a demonstration for 3km cloud assimilation. No evaluation of induced moist bias, but successful 3km application was a first.

### 3.3. GOES Imager Sky Cover Analysis Product

**CIMSS Task Leader: Jordan Gerth**

**CIMSS Support Scientists: James Nelson III, Anthony Schreiner**

**NOAA Collaborators: Robert Aune (ASPB), Andrew Heidinger (ASPB), Jeff Craven (National Weather Service Weather Forecast Office Milwaukee/Sullivan, WI), Eric Lau (National Weather Service Pacific Region Headquarters, Honolulu, HI)**

#### **NOAA Long Term Goals**

- Weather-Ready Nation

#### **NOAA Strategic Goals**

- Serve society’s needs for weather and water
- Provide critical support for the NOAA mission

#### **CIMSS Research Themes**

- Satellite Meteorology Research and Applications
- Environmental Models and Data Assimilation

#### **Proposed Work**

The goal of this project is to increase the frequency of the effective cloud amount (ECA) and cloud top pressure (CTP) products from the current Geostationary Operational Environmental Satellites (GOES), and eventually GOES-R, instruments to produce an average sky cover grid, nationwide, once per hour using multiple scans. Other methods and inputs will eventually be required to complete the grid where ECA and CTP are not valid indicators of sky cover as defined by the National Weather Service’s operational requirements.

Numerous National Weather Service (NWS) forecasters have directly requested such a product to verify an operationally required forecast sky grid because: (1) purely numerical weather prediction methods do not account for radiative transparency of clouds and (2) current satellite-based techniques and algorithms, used alone or in existing analysis tools, do not match the forecasters’ interpretation of the NWS-established definition.

Each NWS office is required to provide sky cover forecasts for a portion of the country as part of their routine operations (e.g., the Milwaukee NWS office provides daily sky cover forecasts for southern Wisconsin). The sky cover quantity indicates the amount of the celestial dome covered by cloud. This is a fractional quantity between 0% and 100%, where 0% is a clear condition and 100% is an overcast condition.

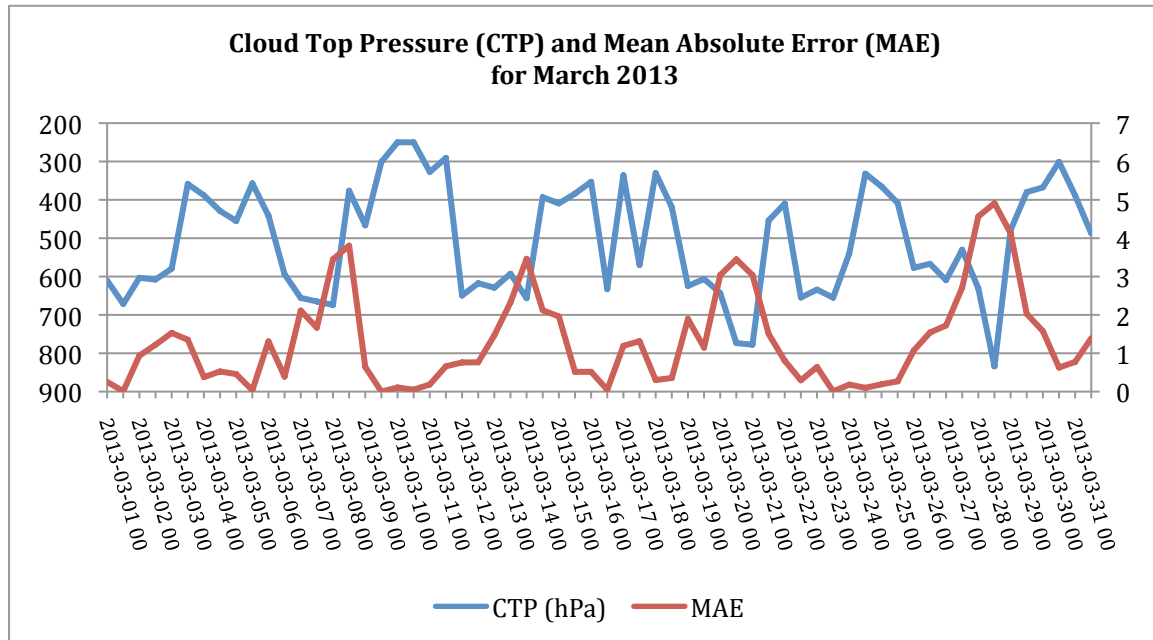
The operational meteorology community currently lacks realistic cloud cover analyses consistent with their expectations. The proposed solution is to design an algorithm for a unified sky cover analysis based on satellite cloud products and in-situ cloud observation datasets already in



existence. Satellite data is well suited for contributing cloud information to an analysis. In this project, satellite products serve as the primary constituents for the unified analysis.

The NWS Web site (<http://weather.gov/>) defines “sky cover” as “the expected amount of opaque clouds (in percent) covering the sky valid for the indicated hour.” There is no probabilistic component, and no definition of “opaque cloud” or “cloud.” It requires validating analyses to account for movement of clouds over a one-hour interval. Currently, ECA, an approximate analog, is produced once hourly from geostationary satellites. ECA is defined as the product of the cloud amount and the emissivity, or opacity, of the cloud, and is a fractional quantity between zero and one. ECA is part of the solution for a unified sky cover analysis, particularly for situations involving partially sunlight-passive clouds, such as cirrostratus.

Figure 3.3.1 indicates that mean absolute error between the GOES sounder ECA is typically highest when low clouds are compared to the NWS’ National Digital Forecast Database (NDFD) 1-hour forecast, which is manually produced as part of the NWS’ daily operational duties.



**Figure 3.3.1.** Relationship between the GOES Sounder Effective Cloud Amount (ECA) and the National Digital Forecast Database (NDFD) sky cover 1-hr forecast.

This relationship is found through implementing a linear model where the objective function is to minimize absolute error between ECA and NDFD 1-hr forecast. At least 250 ECA and NDFD matches are used, which is approximately 2.5% of all points on the test grid (but not all points are considered), centered on the Midwestern United States. Clear points are excluded. The set of points contributing to the objective function for a given time are all within 100 hPa of a central pressure level. Comparisons occur at 00 and 12 UTC daily for the entire month of March 2013.

In the first year of this project, the frequency of ECA and CTP products from the imager and sounder on current geostationary satellites were increased to produce an average sky cover grid, nationwide, once per hour using multiple scans, and compared to in-situ observations.





## Summary of Accomplishments and Findings

This project, for the first time, creates a scientific formulation for the sky cover grid based on the existing definitions and forecaster interpretations. The initial product, the hour-averaged ECA, is the first step toward a better definition for the sky grid, which adds significant value to the existing satellite cloud products.

There are some situations where ECA is not a valid indicator of sky cover (e.g., a broken cumulus field; thick cirrus). The final product will require additional input from other observations. Depending on feedback from the initial product, subsequent work will pursue identifying techniques which match the NWS requirement for the operational sky cover grid. The way to achieve the best result will likely be through the use of linear optimization.

A cross-cutting priority across all of NOAA's research objectives is a path to operations. An element of this research project is that results will be available in real time and that an avenue will exist to make the cloud analyses and model-produced cloud cover forecasts available to the NWS. CIMSS has established protocols for research to operations activities with the NWS.

## Publications and Conference Reports

*Linear Optimization as a Solution to Improve the Sky Cover Guess, Forecast*

Jordan Gerth, Oral Presentation, National Weather Association Annual Meeting, Madison, Wisconsin, October 10, 2012

Also presented during Eastern Region Virtual Satellite Workshop, February 26, 2013

## References

National Weather Service, cited 2011: National Digital Forecast Database. [Available online at <http://www.nws.noaa.gov/ndfd/definitions.htm>.]

## 3.4. Improvements to the Advanced Dvorak Technique (ADT)

**CIMSS Task Leaders: Chris Velden and Tim Olander**

**CIMSS Support Scientist: John Sears**

**NOAA Collaborators: Mike Turk (SAB), Jack Beven (NHC)**

**NOAA Long Term Goals**

- Weather-Ready Nation

**NOAA Strategic Goals**

- Serve society's needs for weather and water
- Provide critical support for the NOAA mission

**CIMSS Research Themes**

- Satellite Meteorology Research and Applications
- Satellite Sensors and Techniques

## Proposed Work

The Advanced Dvorak Technique (ADT, Olander and Velden 2007) is an algorithm designed to provide objective estimates of hurricane intensity from GOES and other geostationary satellites. Its long-term development has been partially supported by GIMPAP, and the latest algorithm is currently being transitioned through a PSDI effort into NESDIS operations at the Satellite Analysis Branch. The National Hurricane Center (NHC) now routinely accesses the ADT data as part of its hurricane analysis and forecast suite of tools.



In support of the importance of the ADT in hurricane analysis at the U.S. operational centers, a joint User Request was recently submitted to the NESDIS SPSRB by NHC, CPHC (Central Pacific Hurricane Center), and JTWC (Joint Typhoon Warning Center). The request, Request NO: 1104-0003, Title: “Continue operational transition and upgrade support of the ADT,” was approved by the SPSRB for funding considerations starting in FY12. This GIMPAP project follows the above User Request guidance, and the work planned to enhance the ADT capabilities will (if successful) have an operational transition component proposed upon successful completion.

In the latest evaluations of the ADT by the aforementioned operational Tropical Analysis Centers, one of the primary requests is to extend the applicability of the algorithm to operate on pre-depression systems. These systems are typically the tropical disturbances that warrant an “Invest,” and often have Dvorak T-numbers of 1.0 or 1.5. The current ADT must “wait” for the first official Center bulletin identifying an invest system as a Tropical Depression, to begin supplying objective intensity estimates. The forecasters would like an algorithm that objectively identifies weak systems, and picks up the ones that eventually develop into tropical cyclones. In effect, the request is to develop a “front end” for the current ADT, to help with guidance on TC systems undergoing genesis.

### **Summary of Accomplishments and Findings**

A critical part for the ADT to be able to operate on pre-genesis tropical disturbances is the accurate identification of coherent systems that have a good chance to develop, and this is the primary goal of the CIMSS Tropical Cloud Cluster Identification and Tracking Algorithm. A prototype algorithm to identify and track coherent tropical cloud clusters (TCCs; candidate TCs) has been developed at CIMSS. Adaptation of this TCC-tracking algorithm to operate on real-time imagery has been completed, and assessment is underway (example, Figure 3.4.1 below). A subsequent methodology to estimate the likelihood of TCC development (probabilistic) has been obtained from collaborators on the project.

An example of the CIMSS Tropical Cloud Cluster Identification and Tracking Algorithm is given in Figure 3.4.1. Clusters are identified by the combination of four parametric fields. The first two fields are the percent of pixels within empirically-prescribed radii of each grid point in the IR image domain (1-deg. Resolution grid), that exceed either the 255K or 230K brightness temperature (BT) thresholds, respectively. The third field is a correlation analysis, created by comparing a BT template from a prototypical tropical storm to all grid points in the selected image. The last field is a latitude function, which maximizes at 10 degrees latitude and minimizes outside the climatological zone (95% likelihood) for TC genesis defined by the HURDAT dataset. These four fields are averaged into single “final score,” where local maxima must exceed an empirically-determined 0.45 in order to be tracked. In the event that multiple maxima occur within 2 degrees of one another, all such maxima are iteratively averaged by a weight assigned from the 230K percentage until only a single cluster remains.

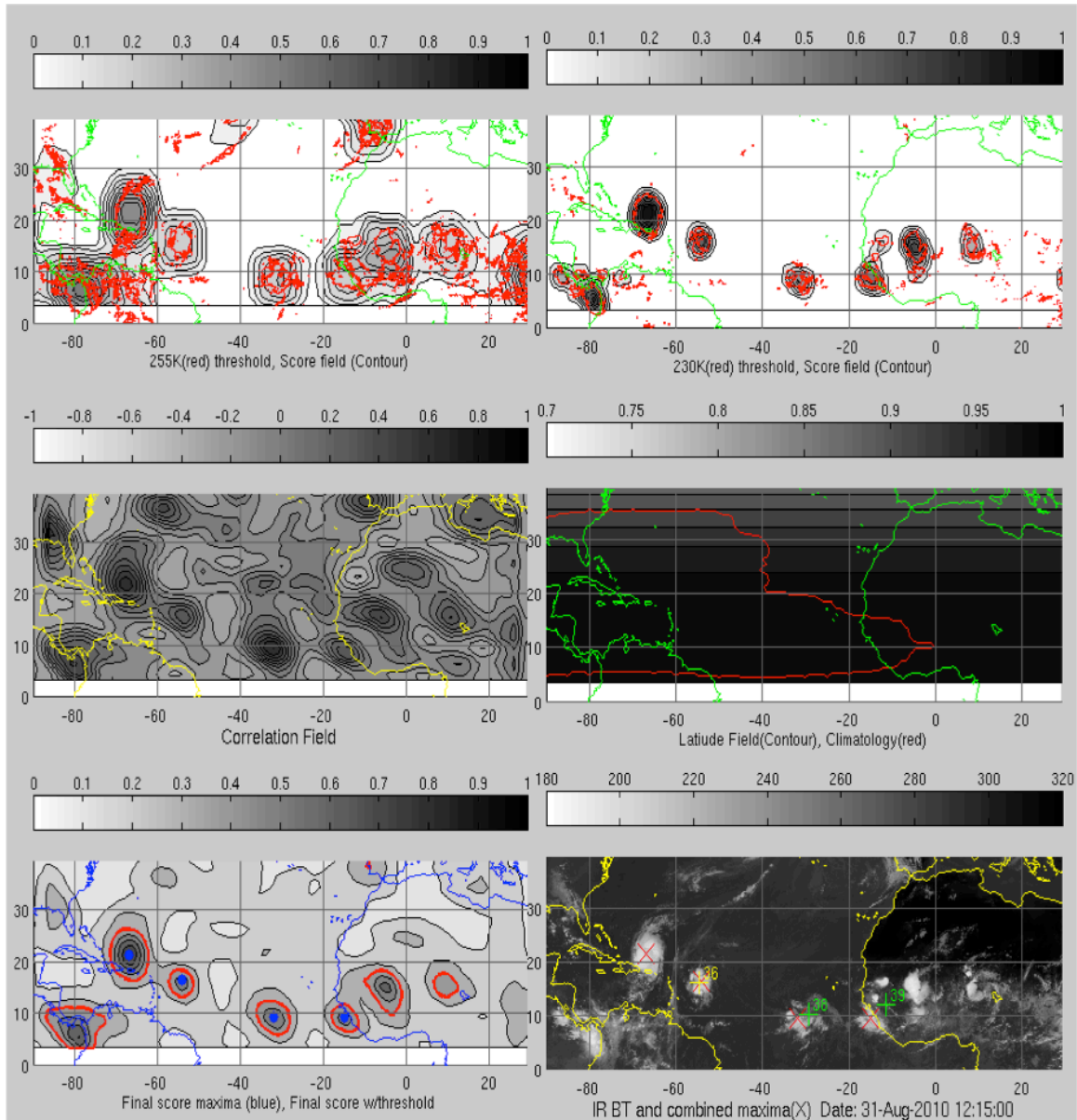
### **Publications and Conference Reports**

Olander, T. and C. Velden, 2012: The Current Status of the UW-CIMSS Advanced Dvorak Technique, 30<sup>th</sup> AMS Hurricanes and Tropical Meteorology Conference, Ponte Vedra Beach, FL, April 15-20.



## References

Olander, T.L. and C.S. Velden, 2007: The Advanced Dvorak Technique: Continued Development of an Objective Scheme to Estimate Tropical Cyclone Intensity Using Geostationary Infrared Satellite Imagery. *Wea. & Forecasting*, **22**, 287-298.



**Figure 3.4.1.** Example from 31 Aug., 2010. Top Left: IR 255K BT contour (red), 255K BT scoring field [%] shaded. Top Right: IR BT 230K contour (red), 230K BT scoring field [%] shaded. Middle Left: Correlation field of IR BT with prototype tropical storm template (shading). Middle Right: Climatological extent of Atlantic genesis in red contour, shading for latitude weighting. Bottom Left: Combined BT scoring field [%] shaded, local scoring maxima (blue), and threshold (0.45) for accepted maxima (red contour). Bottom Right: IR image and final cluster algorithm center fixes (red X), and PREDICT field campaign designated centers (crosses/numbers; yellow=TD, and system north of Puerto Rico is Hurricane Earl).



### 3.5. GOES Biomass Burning Research and Applications

**CIMSS Task Leader: Chris Schmidt**

**CIMSS Support Scientists: Jay Hoffman, Jason Brunner, Elaine Prins (UW-Madison/CIMSS-Consultant)**

**NOAA Collaborators: Mark Ruminski (NOAA/NESDIS), Robert Rabin (NOAA/NSSL), Phillip Bothwell (NOAA/NWS/SPC)**

#### **NOAA Long Term Goals**

- Climate Adaptation and Mitigation
- Weather-Ready Nation

#### **NOAA Strategic Goals**

- Understand climate variability and change to enhance society's ability to plan and respond
- Support the nation's commerce with information for safe, efficient and environmentally sound transportation
- Provide critical support for the NOAA mission

#### **CIMSS Research Themes**

- Satellite Meteorology Research and Applications
- Satellite Sensors and Techniques

#### **Proposed Work**

The GOES Wildfire Automated Biomass Burning Algorithm (WFABBA) has been an Operational product since 2001. The upgraded WFABBA Version 6.5 (v65) has been running at NESDIS Operations since 2010, providing fire detections and characterizations, as well as metadata, for the GOES satellites and the Meteosat and MTSAT series of satellites. The WFABBA data are used in the Hazard Mapping System. While the algorithm performs well overall, the false alarm rate can be lowered. This project researches and develops techniques to reduce false alarms in WFABBA data, an issue that has been a challenge for the Hazard Mapping System operators. It completed work on the "fire potential" product that began development under the previous two year GIMPAP funding cycle that was developed in collaboration with Dr R. Rabin (NOAA/NSSL) and Dr. P. Bothwell (NOAA/NWS, Storm Prediction Center). That research has utilized the Version 6.5 WFABBA database to create a climatology of wildfires from the WFABBA data (1995-2011) and examined whether that data could be used in conjunction with other ancillary information to create a "fire potential" product. WFABBA support for Korea's COMS as part of the geostationary fire monitoring network is being created now that data have become available. The same will be done for India's INSAT-3D if the data become available. CIMSS continues to work with GEOS, GTOS GOFD/GOLD, CEOS, and CGMS to foster the development and implementation of a global geostationary fire monitoring network with international involvement. CIMSS also continues to support improved product utilization by supporting integration of the WFABBA into smoke and aerosol forecasting efforts.

#### **Summary of Accomplishments and Findings**

The CIMSS team determined in the summer of 2012 that the "fire potential" product did not show sufficient promise to warrant becoming an operational product. However, the research did show some correlation between fires detected by the WFABBA and lightning data in certain regions. A paper summarizing those results has been drafted and will be submitted for peer-review.

The work on false alarms has proceeded with an initial focus on addressing a long-standing 3.9  $\mu\text{m}$  band saturation point issue that has impacted product quality and the false alarm rate. For the

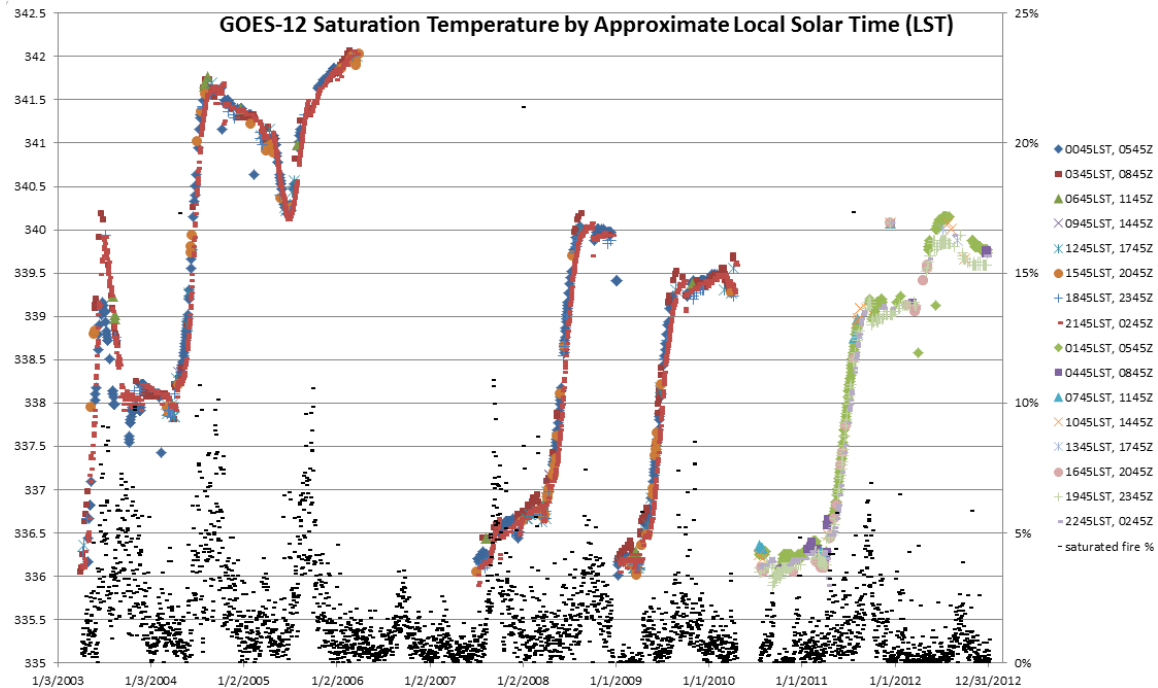


GOES satellites it has been observed that the saturation point of the 3.9  $\mu\text{m}$  band will change over time, in some cases by a Kelvin or more. This can have a substantial impact on the quality and reliability of fire detection and characterization. As part of its quality control data, the WFABBA produces histograms of the raw GVAR counts in each AREA file it processes, and that histogram can be used to estimate the saturation point by searching for a sharp peak at the high count/high temperature end of the histogram. The histograms from all v65 WFABBA data (1995-present for GOES-East, 2009-present for GOES-West and all of GOES-SA) were processed and the results showed more variation in the saturation point than had been anticipated. It was known that GOES-12 had substantial saturation point variation likely due to a source of contamination onboard the satellite, which necessitates occasionally “baking off” the residue by heating the optics. However, other recent GOES also have shown variations that underscore the need for a dynamic assessment of the saturation point of the 3.9  $\mu\text{m}$  band.

When the saturation point is under-estimated a large number of pixels are classified as saturated fires which may in fact not be. This can lead to false alarms that are not true fire pixels but because they are treated as saturated fires do not receive all of the screening that a non-saturated potential fire pixel does. It also leads to mischaracterization of the fire. A saturated pixel should not be characterized for size, temperature, and fire radiative power (FRP) as the radiance data do not reflect the properties of the fire and at best represent a lower bound for the FRP. Size and temperature are useless for a saturated pixel given the nature of the retrieval.

Figure 3.5.1 illustrates the saturation point trend for GOES-12. The series are broken up by local solar time, and slight diurnal variations are visible. The diurnal variations are likely due to slight offsets introduced when the Imager is calibrated, perhaps due to spacecraft heating or stray light. The much larger variations that occur over time are due to the contamination of the optics mentioned earlier. “Dirty” optics allow the sensor to read higher temperatures before it saturates. Also shown are the percentage of all reported fires that were saturated, which changes with time. The saturation point assumed by v65 was 336.4 K until 2011, when it was changed to 339 K. The percentage of saturated fires appears to drop at that time, however that is also when XGOHI was in effect after GOES-12 switched from GOES-East to become GOES-SA, and along with that there was a remapping that altered the input data. The location shift also changed the time of day when most saturation point solutions were found, hence the shift to the green plot markers and away from the reds and oranges.

Figure 3.5.2 shows histograms of fires by category and observed brightness temperature at different full-disk scan times for GOES-12 in 2010. The histograms are broken up by fire category and stacked, showing the total number of fires and relative proportion of each category. Dark blue is for low possibility fires, light blue is for medium possibility fires, orange is for high possibility fires, magenta is for cloud-covered fires, red is for fires that have been characterized (also known as processed), and yellow is for saturated fires. There are several notable features. For example, at 11:45 UTC there is a spike in low possibility fires with observed brightness temperatures around 320 K. These are false alarms due to forward scattering of sunlight and indicate that the WFABBA’s screens for those situations require improvement. The right-most peak at all image times indicates saturation of the sensor. If the saturation point is set correctly that peak should be almost completely yellow. Some other categories that are just below saturation may fall in the same bin, but the large proportions of fires that are not classified as saturated at 14:45, 17:45, 20:45, and 23:45 UTC shows that the saturation point had drifted below the assumed temperature.



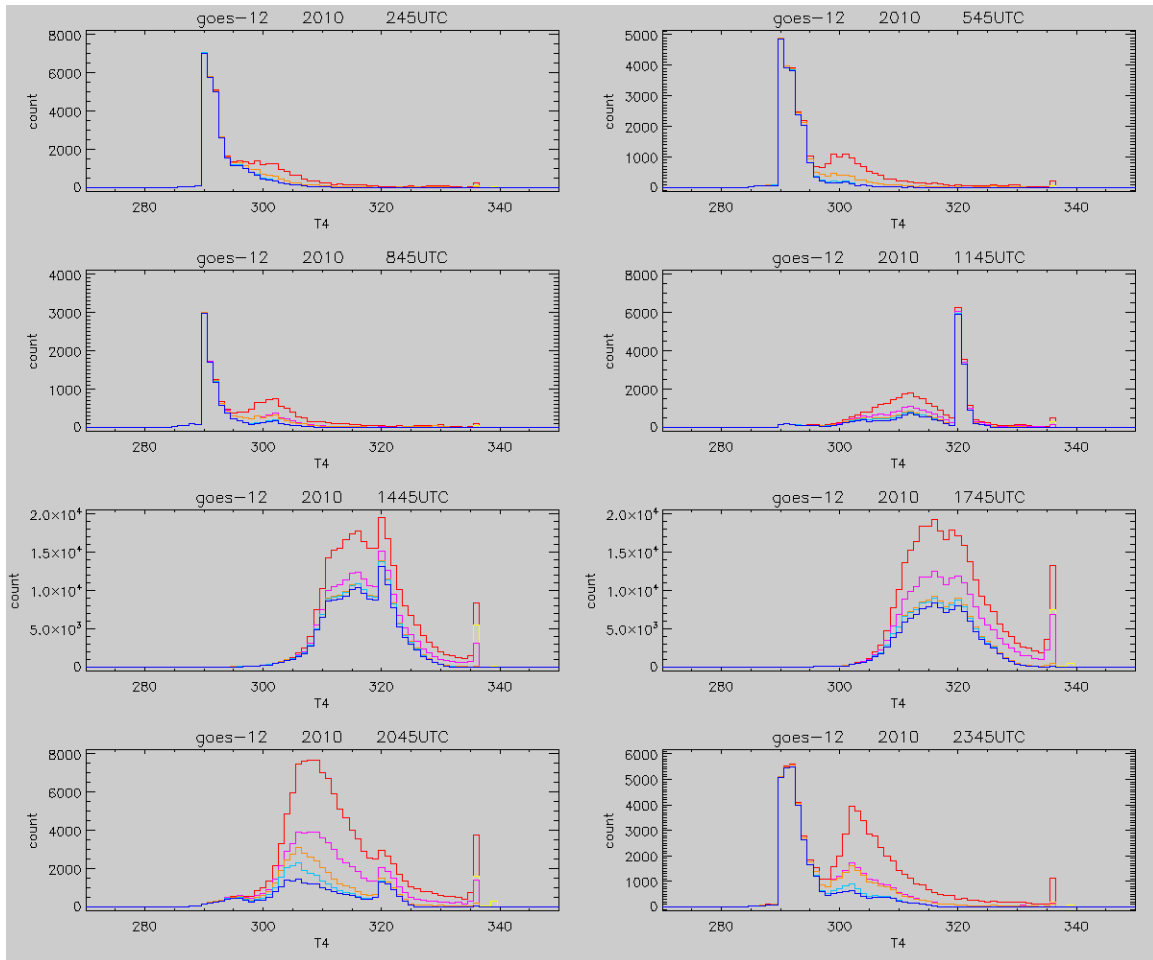
**Figure 3.5.1.** GOES-12 3.9  $\mu\text{m}$  saturation temperature over time plotted as a function of local solar time. The large shifts caused by onboard contamination of the Imager's optics and subsequent cleanings are clearly visible.

The method used to find the saturation point in the v65 histograms is being adapted to real-time processing and will be part of the final package of improvements.

Development of techniques for addressing the shortcomings of temporal filtering has begun. The temporal filtering developed for older versions of the WFABBA is still in use with v65. Given the higher temporal refresh rate, this has allowed for a much larger number of false alarms to pass that screen. The old approach requires at least 6 scans of the location in the last 12 hours and that a fire pixel (of any category) appear at least one more time aside from in the current image. A new, smarter approach will take into account the time difference between the image scans and adjust the screen accordingly. For example, if the time between scans is 5 minutes, and the fire appears as a low probability false alarm in the last two scans, the algorithm should wait until either the category changes to a higher one or the fire is found again 30 minutes or more after the first appearance. That change alone will reduce the number of low possibility false alarms substantially.

### Publications and Conference Reports

Brunner, Jason C.; Schmidt, C. C.; Prins, E. M.; Hoffman, J. P.; Schroeder, W. and Csiszar, I. A. Western Hemisphere diurnal fire activity 1995-2012: Description and initial fire trend analysis of the GOES-East version 6.5 WFABBA data archive. Conference on Applied Climatology, 20th, Austin, TX, 6-10 January 2013. American Meteorological Society, Boston, MA, 2013, abstract only.



**Figure 3.5.2.** Histograms of fires binned by observed 3.9  $\mu\text{m}$  brightness temperature, separated by full-disk scan time and category.

### 3.6. Using GOES and NEXRAD Data to Improve Lake Effect Snowfall Estimates

**CIMSS Task Leader: Mark Kulie**

**CIMSS Support Scientists: Andi Walther, Ralf Bennartz**

**NOAA Collaborator: Andrew Heidinger**

#### **NOAA Long Term Goals**

- Climate Adaptation and Mitigation
- Weather-Ready Nation

#### **NOAA Strategic Goals**

- Serve society's needs for weather and water
- Understand climate variability and change to enhance society's ability to plan and respond
- Support the nation's commerce with information for safe, efficient and environmentally sound transportation
- Provide critical support for the NOAA mission

#### **CIMSS Research Themes**

- Satellite Meteorology Research and Applications



- Satellite Sensors and Techniques

### **Proposed Work**

Lake effect snow (LES) associated with winter cold air outbreaks commonly occurs over the Great Lakes region. LES plays a key role in the Great Lakes watershed hydrological cycle and also exerts significant societal and economical influences by inflating annual snowfall amounts above ~200-300" in prominent Great Lakes snowbelt regions. Additionally, the frequency of LES events has steadily increased over the past few decades, and links to decreased ice cover and warmer surface waters consistent with a warming climate have been hypothesized (Burnett et al., 2003).

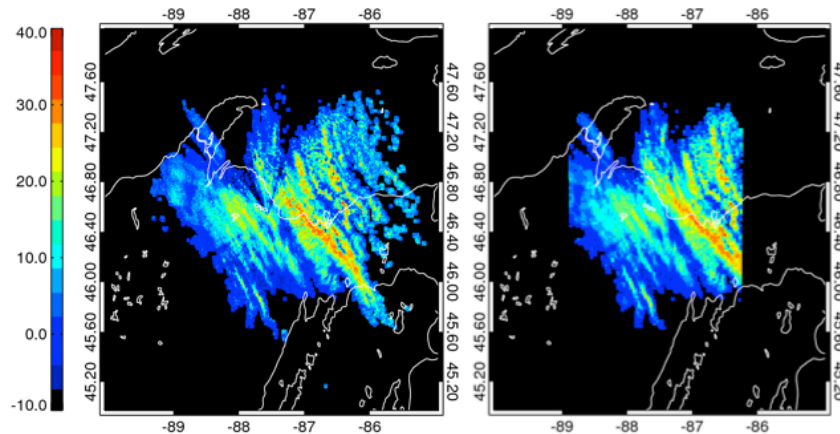
Despite being the primary observational platform used for monitoring LES, the NEXRAD network does not effectively detect these important precipitation events at longer distances from NEXRAD sites since the lowest radar elevation angle overshoots shallow LES structures. In an effort to mitigate NEXRAD observational shortcomings of LES events, we propose using satellite data products to improve both nowcasting capabilities and remotely sensed snowfall estimates. Satellite data provide valuable information about LES over the Great Lakes, and we propose developing methods using GOES-derived (or polar orbiter data in the demonstration phase) NOAA Algorithm Working Group (AWG) cloud products to extend NEXRAD coverage in regions currently devoid of radar observations. Specific goals of this project include:

- Collocated AWG cloud products and NEXRAD observations within ~100 km of Great Lakes radar sites will be used to 'calibrate' GOES products for LES events. NEXRAD reflectivity and derived products (e.g., snowfall rate) will be linked to AWG cloud properties. A subset of representative LES cases will be used to hone our methodologies for initial proof-of-concept studies;
- After initial calibration testing is completed, a GOES LES product will be created to augment NEXRAD coverage in data void regions and improve nowcasting and LES monitoring capabilities. The product will be demonstrated to Great Lakes region National Weather Service Forecast Offices (NWSFO), and collaborative research efforts will be undertaken to test and improve the product; and
- Snowfall accumulation validation exercises will be undertaken with the assistance of NWS snowfall accumulation observations of LES events.

### **Summary of Accomplishments and Findings**

NEXRAD Level II data and corresponding AWG cloud products for widespread LES events in January and February 2013 have been archived for testing purposes. An additional dataset comprised of LES cases from 2009 through 2012 will be archived and processed in the near future. This test database contains a geographically diverse dataset covering the entire Great Lakes Basin with different modes of LES represented (e.g., multi-band, wind-parallel snow bands versus convergence-driven, single-band structures versus upslope, terrain-induced snowfall.) Additionally, software has been written and tested to temporally and spatially collocate the radar and satellite datasets. The radar data is currently matched to the satellite in its native range/azimuth coordinate system and convolved to AWG product resolution using a simple neighboring pixel averaging method. Further methodological refinements will be undertaken to improve the radar-AWG product matching by interpolating and gridding the native Level II radar data into Constant Altitude Plan Position Indicator (CAPPI) products at the 1 km height level to reduce range/height effects and allow for more consistent matching with the satellite products' resolution. A sample Level II NEXRAD image and its corresponding 1 km height CAPPI product (2 km horizontal resolution) for a LES event near Marquette, MI (KMQT) are shown in Figure 3.6.1.

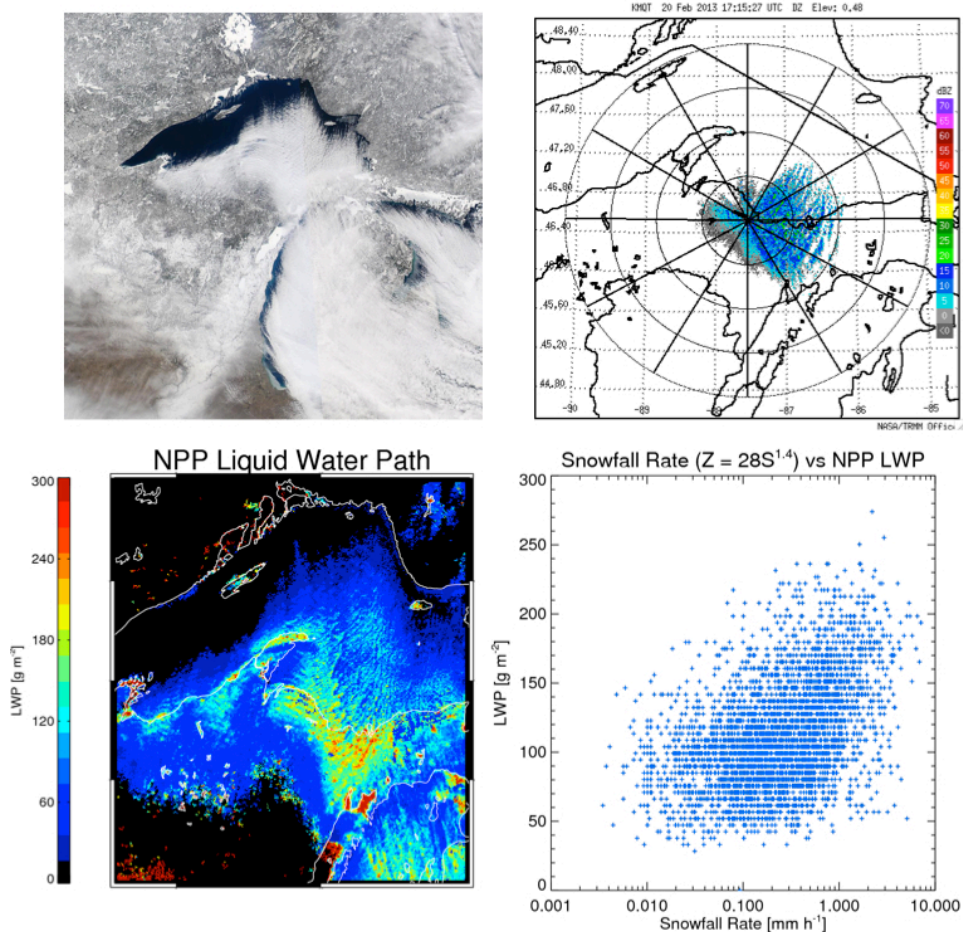




**Figure 3.6.1.** KMQT base-scan Level II radar reflectivity (dBZ) and 1 km CAPPI (2 km horizontal resolution) radar reflectivity (dBZ) for LES event on 12 December 2012 at 0556 UTC. CAPPI products will be used in the final NEXRAD-satellite matching procedure.

We are currently undertaking the AWG cloud product assessment phase to identify useful AWG cloud products for LES events that can be empirically related to NEXRAD-derived snowfall rates and develop NEXRAD/AWG cloud product snowfall rate relationships. Figure 3.6.2 highlights a LES case from 20 February 2013 and displays an AQUA MODIS true color high-resolution composite image for 20 February 2013, the KMQT NEXRAD base reflectivity scan at 1715 UTC, the AWG cloud liquid water path product derived from a near-coincident Suomi NPP satellite overpass, and a scatter plot of NEXRAD-derived snowfall rates versus cloud liquid water path (LWP). Fig. 3.6.2 illustrates the pathway for deriving empirical relationships between LES NEXRAD snowfall rates and AWG cloud products. The LWP product seems particularly promising compared to other cloud products (e.g., cloud effective radius, cloud top pressure, etc.) for this case (not shown). This preliminary 20 February 2013 analysis will be amended with other polar satellite overpasses for this case, and GOES cloud products will also be assessed. The assessment phase will also compare different Great Lakes radar sites for the same LES event shown in Figure 3.6.2, as well as other recent LES cases that have been compiled in an event database.

A site visit was made to the Marquette, MI NWSFO in February 2013 to discuss collaborative research activities during the testing phase of this project, and eventual operational testing once the product is deemed mature in Year 2. The Marquette, MI NWS staff enthusiastically supports this project and provided valuable initial feedback regarding the operational utility of the proposed LES GOES product, especially helping forecasters distinguish between lake effect advisory versus warning scenarios by providing a quantitative estimate of snowfall intensity from GOES observations. The product will also help fill the large KMQT radar data void over Lake Superior and the Keweenaw Peninsula. Finally, the NWS staff will provide much-needed assistance to validate snowfall estimates using ground-based snowfall accumulation measurements both at the office and from the extensive cooperative observing network throughout their operational county warning area.



**Figure 3.6.2.** Aqua MODIS true color composite image (top left), KMQT NEXRAD base scan radar reflectivity (dBZ) at 1715 UTC (top right), Suomi NPP AWG cloud LWP ( $\text{g m}^{-2}$ ) (bottom left) near 1715 UTC, and NEXRAD-derived snowfall rate ( $\text{mm h}^{-1}$ ) versus LWP for 1715 UTC 20 Feb 2013.

### References

Burnett, A. W., M. E. Kirby, H. T. Mullins, and W. P. Patterson, 2003: Increasing Great Lake-effect snowfall during the twentieth century: A regional response to global warming? *J. Climate*, **16**, 3535-3542.

### 3.7. Enhanced Downslope Windstorm Prediction with GOES Warning Indicators

**CIMSS Task Leader: Anthony Wimmers**

**NOAA Collaborators: Daniel Lindsey (Co-PI, CIRA), Randy Graham (NWS SLC), Stan Czyzyk (NWS VEF), Eric Thaler (NWS BOU)**

#### NOAA Long Term Goals

- Weather-Ready Nation

#### NOAA Strategic Goals

- Serve society's needs for weather and water



- Support the nation's commerce with information for safe, efficient and environmentally sound transportation
- Provide critical support for the NOAA mission

### **CIMSS Research Themes**

- Satellite Meteorology Research and Applications
- Environmental Models and Data Assimilation

### **Proposed Work**

This is a project to improve the prediction of downslope wind events at select western U.S. locations using a combination of GOES imagery and output from numerical models. A statistical method was previously developed to predict downslope windstorm events in Ft. Collins, CO using model output such as midtropospheric directional shear and thermal stability. Our project extends this work to add GOES predictors that are not well resolved in numerical models (such as evidence of orographically-forced mesoscale vertical motion), as well as to create similar models for other locations that are prone to severe downslope winds.

The objectives for 2012 (Aug-Dec) were:

- Choose surface stations and collect several years of data,
- Collect and examine North American Regional Reanalysis (NARR) data to determine ideal model predictors for each site, and
- Develop an updated version of the GOES-derived downslope signatures algorithm to work with the prediction model.

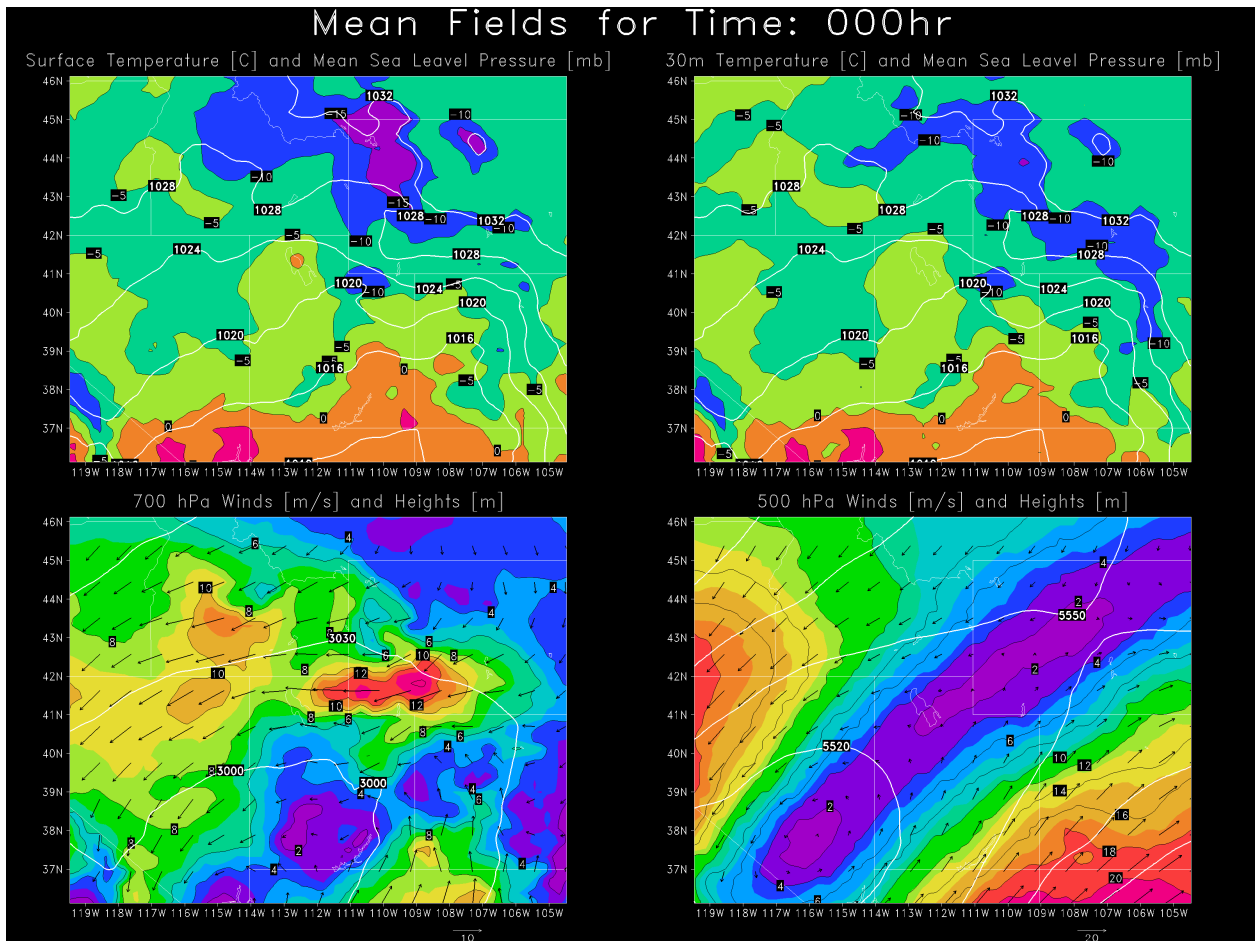
### **Summary of Accomplishments and Findings**

Our accomplishments in meeting the objectives for the year are as follows:

- *Choose surface stations and collect several years of data.*  
As a first step in the project we are using the Fort Collins, CO station. In coordination with Randy Graham at the SLC NWS office, have selected three additional stations in Utah. Surface observations have been obtained for these stations, and the North American Regional Reanalysis (NARR) dataset will be used to help select the numerical model predictors;
- *Collect and examine NARR data to determine ideal model predictors for each site.*  
NARR data have been collected and extensively studied for the Fort Collins location. We have also recently gathered the NARR data for observed high wind cases at Hill Air Force Base in Utah (north of Salt Lake City, just west of the Wasatch Mountain Range). A preliminary look at the conditions favorable for downslope windstorms at this location show some promising signals. Figure 3.7.1 shows the means of several fields for the observed high wind cases at Hill AFB. One noteworthy signal is the 700 mb easterly wind speed maximum in southwestern Wyoming; this will likely be used as one of the non-satellite predictors; and
- *Develop an updated version of the GOES-derived downslope signatures algorithm to work with the prediction model.*  
GOES Water Vapor (WV) imagery was collected for about 1250 events to examine potential predictors for Ft. Collins high wind events. A set of 9 potential predictors was tested using a logistical regression method, and several of the predictors showed great promise in improving the forecasts for downslope winds. One example is shown in below in Figure 3.7.2: the "Terrain Pattern Score." This derived product indicates the amount of alignment between the patterns in WV brightness temperatures and the terrain underneath, which serves to identify downslope wind conditions such as drying patterns and updraft-



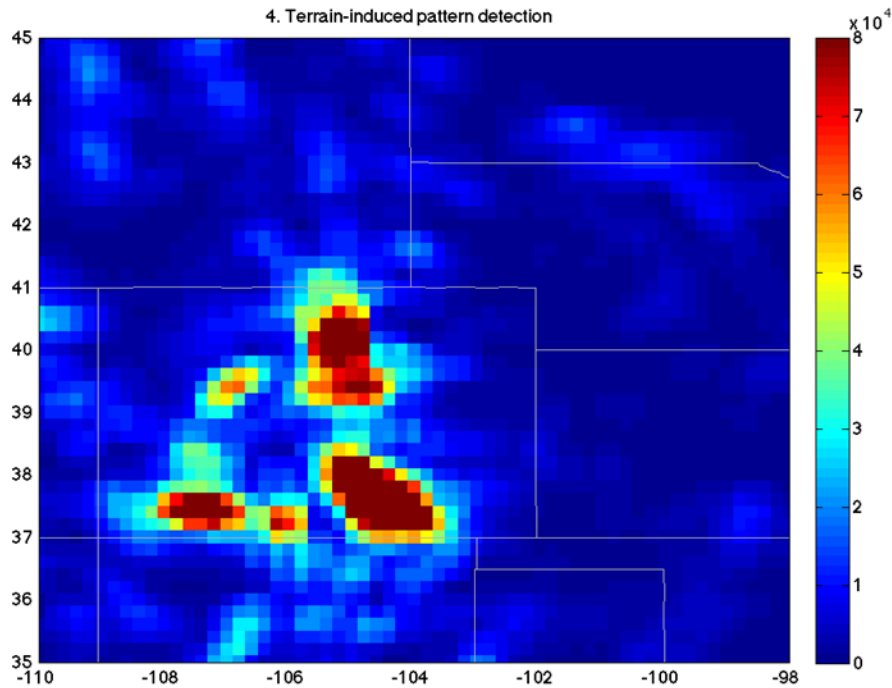
induced cloud banks. The example below is from 4 January 2006 at the time of an observed downslope windstorm in Ft. Collins.



**Figure 3.7.1.** Mean fields of Surface Temperature and Mean Sea Level Pressure (top left), 30 m Temperature and Mean Sea Level Pressure (top right), 700 mb wind and height (bottom left), and 500 mb wind and height (bottom right), for all downslope wind events at Hill Air Force Base since 1979, from the North American Regional Reanalysis.

### Publications and Conference Reports

Lindsey, D. T., B. McNoldy, Z. Finch, D. Henderson, D. Lerach, R. Seigel, J. Steinweg-Woods, E. Stuckmeyer, D. Van Cleave, G. Williams and M. Woloszyn, 2011: A high wind statistical prediction model for the northern Front Range of Colorado. *Electr. J. Oper. Meteor.*, 2011-EJ03. [http://rammb.cira.colostate.edu/products/fort\\_collins\\_high\\_wind\\_probability/docs/high\\_wind\\_model.pdf](http://rammb.cira.colostate.edu/products/fort_collins_high_wind_probability/docs/high_wind_model.pdf)



**Figure 3.7.2.** GOES Water Vapor-derived Terrain Pattern Score over Colorado valid at 0015 UTC on 4 January 2006, at the same time as an ongoing downslope windstorm in Ft. Collins, CO.

### 3.8. Probabilistic Nearcasting of Severe Convection Using the Temporal Evolution of GOES-derived Deep Convective Properties, NEXRAD and NWP

**CIMSS Task Leaders:** John Cintineo

**CIMSS Support Scientist:** Justin Sieglaff

**NOAA Collaborators:** Mike Pavolonis

#### NOAA Long Term Goals

- Weather-Ready Nation

#### NOAA Strategic Goals

- Serve society's needs for weather and water
- Support the nation's commerce with information for safe, efficient and environmentally sound transportation
- Provide critical support for the NOAA mission

#### CIMSS Research Themes

- Satellite Meteorology Research and Applications
- Satellite Sensors and Techniques

#### Proposed Work

The goal of this project is to utilize temporal trends in GOES derived cloud properties (e.g., emissivity, cloud phase, optical depth, etc.), NWP fields (e.g., CAPE and shear, etc.), and NEXRAD to objectively determine the probability that a growing cumulus cloud object will produce severe weather in the near future (0-2 hours). A flexible probabilistic model is utilized such that additional data sources (e.g., lightning) can be incorporated at a later time. Results achieved thus far indicate that the probabilistic model (a naïve Bayesian classifier) can often



predict that severe weather is likely to occur 10 minutes or more prior to the appearance of traditional NEXRAD severe weather signatures. The end goal of this work is to improve the lead time and accuracy of NWS-issued severe weather warnings and support “warn-on-forecasting” efforts.

The outcome of this project directly addresses NOAA’s mission goal to improve weather forecasts and warnings. Specifically, the addition of NEXRAD and NWP (RAP) data will improve the skill of the probabilistic model and potentially allow for more specific predictions (e.g., probability of hail, tornado, etc.). The proposed research addresses the need of the NWS to have access to “fused” products that are more valuable than satellite-alone, radar-alone, or NWP-alone products. A fused product such as this will help forecasters quickly interrogate pertinent information from streaming data from a variety of sources to make a decision. In an operational setting, forecasters would be able to use this tool to issue a severe thunderstorm or tornado warning or to issue a severe weather statement prior to observation of radar-indicated severe criteria depending on a storm cell’s assigned severe probability.

### **Summary of Accomplishments and Findings**

Using the WDSS-II object tracking software and a UW-Madison/CIMSS developed post-processing algorithm, we have developed the capability to track GOES cloud objects through time and space. The cloud object tracking allows the time rate of change of certain cloud properties (e.g., cloud emissivity, cloud phase, cloud optical depth, etc.) within each object to be quantified. The time rates of change in cloud properties that capture the vertical and horizontal cloud growth, trends in cloud microphysics, and NWP-derived MUCAPE and effective shear are used as predictors in the probabilistic model, based on a training set of 120 severe thunderstorms and ~1000 non-severe thunderstorms. Other relevant NWP fields and NEXRAD-derived cloud microphysical and dynamical time trends will be incorporated into the probabilistic model and the end products will be evaluated using severe weather reports and/or severe weather warnings. The tracking algorithm and probabilistic model are being run in real-time at CIMSS in order to expand the training data, obtain an independent validation dataset, and to identify and develop model enhancements.

An example case of the output of the algorithm is shown in Figure 3.8.1. A developing thunderstorm in central South Dakota achieved a probability of severe of 65% at 22:32 UTC, 21 minutes prior to when the NWS first issued a severe thunderstorm warning and 49 minutes prior to the first report of severe hail. The statistical model used to produce the results shown in Figure 3.8.1 only utilized satellite and NWP based predictors. The addition of NEXRAD information should further enhance the algorithm’s skill.

### **Publications and Conference Reports**

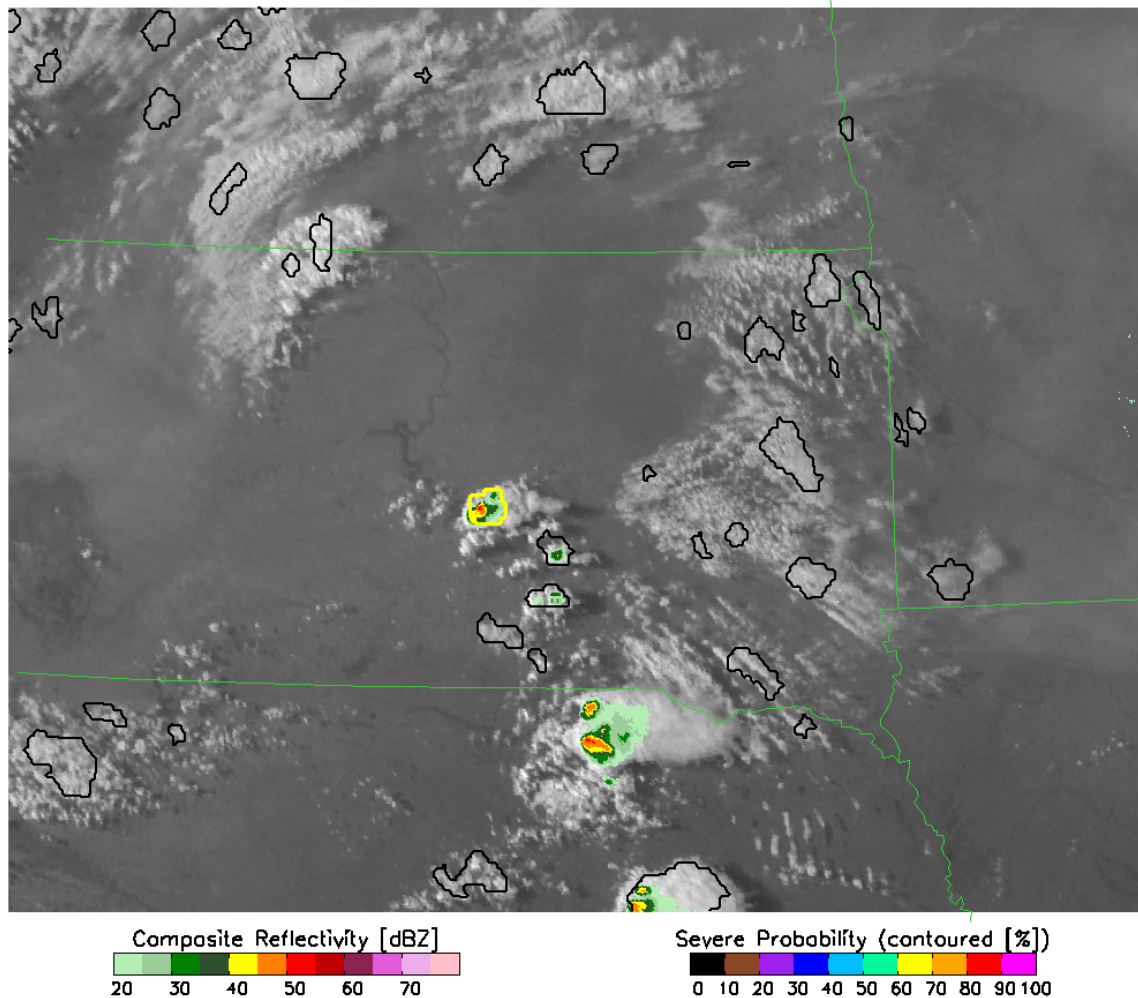
Cintineo, J. L., Pavolonis, M. J., Sieglaff, J. M., and Heidinger, A. K., 2013: Evolution of severe and non-severe convection inferred from GOES-derived cloud properties. *Submitted December 2012*.

Sieglaff, J. M., D. C. Hartung, W. F. Feltz, L. M. Counce, and V. Lakshmanan, 2013: Development and application of a satellite-based convective cloud object-tracking methodology: A multipurpose data fusion tool. *Accepted, J. Tech.*

Cintineo, J. L., M. J. Pavolonis, J. M. Sieglaff, and D. T. Lindsey, 2012: Probabilistic Forecasting of Severe Convection. *37<sup>th</sup> Natl. Wea. Assoc. Annual Meeting*, Madison, WI, Natl. Wea. Assoc., F18.1.



GOES-13 Severe Storm Probability 20120904-2232 UTC



**Figure 3.8.1.** Demonstration of the probabilistic severe weather prediction model for storms in South Dakota on September 4, 2012 at 22:32 UTC. Contours represent the bounds of cloud objects being tracked at this time and are colored by the probability that the storm will produce severe weather in the future. The contours are overlaid on GOES-13 visible imagery and NEXRAD composite reflectivity.

### References

Sieglaff, J. M., M. Pavolonis, D. Hartung, and J. Cintineo, 2012: Probabilistic Nowcasting of Severe Convection using the Temporal Evolution of Satellite-derived Deep Convective Cloud Properties, presented at Annual AMS Meeting, New Orleans, LA.

Pavolonis, M. J., D. Hartung, and J. Sieglaff, 2011: The temporal evolution of satellite-derived deep convective cloud properties, presented at EGU Annual Meeting, Vienna, Austria.

Pavolonis, Michael. J., 2010: Advances in extracting cloud composition information from spaceborne infrared radiances: A robust alternative to brightness temperatures. Part I: Theory. *J. Applied Meteorology and Climatology*, **49**, 1992-2012.



Lakshmanan, Valliappa, Travis Smith, Gregory Stumpf, and Kurt Hondl, 2007: The Warning Decision Support System-Integrated Information. *Wea. Forecasting*, **25**, 596-612.

#### **4. CIMSS Participation in the Product Systems Development and Implementation (PSDI) for 2012**

##### **4.1. Operational Implementation of the CIMSS Advanced Dvorak Technique**

**CIMSS Task Leaders: Chris Velden and Tim Olander**

**CIMSS Support Scientist: Tony Wimmers**

**NOAA Collaborators: Liqun Ma and Mike Turk (SAB)**

**NOAA Long Term Goals**

- Weather-Ready Nation

**NOAA Strategic Goals**

- Serve society's needs for weather and water
- Provide critical support for the NOAA mission

**CIMSS Research Themes**

- Satellite Meteorology Research and Applications
- Satellite Sensors and Techniques

##### **Proposed Work**

The Advanced Dvorak Technique (ADT, Olander and Velden 2007) is an algorithm designed to provide objective estimates of hurricane intensity from GOES and other geostationary satellites. Its long-term development has been partially supported by GIMPAP, and this proposed task represents the PSDI-supported transition of the latest version of the algorithm into NESDIS operations at the Satellite Analysis Branch. The National Hurricane Center (NHC) now routinely accesses the ADT data as part of its hurricane analysis and forecast suite of tools.

In support of the importance of the ADT in hurricane analysis at the U.S. operational centers, a joint User Request was recently submitted to the NESDIS SPSRB by NHC, CPHC (Central Pacific Hurricane Center), and JTWC (Joint Typhoon Warning Center). The request, Request NO: 1104-0003, Title: "Continue operational transition and upgrade support of the ADT," was approved by the SPSRB for funding considerations starting in FY12. This PSDI project follows the above User Request guidance, and addresses the operational transition component proposed upon successful completion of new science added to the ADT.

##### **Summary of Accomplishments and Findings**

Efforts for this proposed fiscal year have focused on adapting the latest ADT version code into the operational framework at OSPO. Specifically, CIMSS:

- Provided ADT v8.1.4 upgraded version builds to OSPO;
- Integrated Fortran90 version of microwave module into ADT v8.1.4;
- Responded to OSPO feedback on ADT v8.1.4 implementation, testing, and performance evaluation during/after transition;
- Performed verification and validation previously assigned to SAB; and
- Updated documentation.





## Publications and Conference Reports

Olander, T. and C. Velden, 2012: The Current Status of the UW-CIMSS Advanced Dvorak Technique, 30<sup>th</sup> AMS Hurricanes and Tropical Meteorology Conference, Ponte Vedra Beach, FL, April 15-20.

## References

Olander, T.L. and C.S. Velden, 2007: The Advanced Dvorak Technique: Continued Development of an Objective Scheme to Estimate Tropical Cyclone Intensity Using Geostationary Infrared Satellite Imagery. *Wea. & Forecasting*, **22**, 287-298.

## 4.2. Polar Wind Products

### 4.2.1. Metop-B Readiness for CLAVR-x

**CIMSS Task Leader: William Straka III**

**CIMSS Support Scientist: Szuchia Moeller**

**NOAA Collaborator: Andrew Heidinger**

**NOAA Long Term Goals**

- Weather-Ready Nation

**NOAA Strategic Goals**

- Serve society's needs for weather and water
- Understand climate variability and change to enhance society's ability to plan and respond
- Provide critical support for the NOAA mission

**CIMSS Research Themes**

- Satellite Meteorology Research and Applications
- Satellite Sensors and Techniques

### CLAVR-x Proposed Work

On September 17, 2012, the second satellite of the EUMETSAT's Polar System (EPS), MetOp-B, was launched. National Environmental Satellite, Data, and Information Service, Center for Applications and Research (NESDIS/STAR) and the Cooperative Institute for Meteorological Studies (CIMSS) propose to integrate data from MetOp-B into the Advanced Very High Resolution Radiometer (AVHRR) processing system, CLAVR-x (The Extended Clouds from AVHRR processing system). This project includes updating the code, upgrading the algorithms to their latest versions, and upgrading necessary lookup tables. By doing this, CLAVR-x will not only support ongoing operational needs at NCEP, but also extend the CLAVR-x climatology to include MetOp-B. By doing this, there will be a data record from a single sensor over 35 years, allowing for long term climate studies.

### Summary of Accomplishments and Findings

CLAVR-x was modified in order to accommodate the processing of AVHRR data from MetOp-B. This included the update of the lookup tables used by the Pressure Layer Optical Depth (PLOD)/ Pressure layer Fast Algorithm for Atmospheric Transmittances (PFAAST) (Hannon et al., 1996) radiative transfer model (RTM). In addition, CLAVR-x was modified to incorporate the latest cloud mask, cloud top height/temperature/pressure and cloud optical properties algorithms. These algorithms were originally developed by the GOES-R Cloud Algorithm Working group, and expanded for use on multiple sensors. This means there is consistency between the algorithms used by GOES-R and AVHRR, allowing for comparisons once GOES-R is launched.



This update also provides data needed by the IASI post-processing team as well as users at NCEP.

The updated CLAVR-x code was delivered to the Office of Satellite Data Processing and Distribution (OSDPD) in the Winter of 2012 for pre-operational implementation. The updated version of CLAVR-x was successfully tested on a non-operational test computer in OSDPD. Currently testing is going on in the pre-operational testing at OSDPD.

### **Publications and Conference Reports**

Donahue, D., A.K Heidinger, W.C Straka III, C.C. Molling. IPD CLAVR-x Interface Control Document, Clouds from AVHRR Extended (CLAVR-x) Operational Processing System. 2013

Straka, W.C., A.K Heidinger, M. Pavolonis. Clouds from AVHRR Extended version 6.0 (CLAVR-x v6) Program Description Document. 2013

CLAVR-x Critical Design Review (CDR) was held on March 13, 2013.

### **References**

Hannon, S. L. L. Strow, and W. W. McMillan, 1996: Atmospheric infrared fast transmittance models: A comparison of two approaches, Proceedings of SPIE, 2830, 94-105.

### **PFAST Proposed Work**

The METOP-B satellite was launched in 2012 and this project supports the modification of the Clouds from AVHRR Extended (CLAVR-x) processing system. CLAVR-x the operational cloud processing system at NESDIS and has been supported at CIMSS for years. METOP-B represents the 17<sup>th</sup> AVHRR sensor supported by CLAVR-x. The major contribution from CIMSS involves the extension of the fast IR radiative transfer model (PFAAST) to operate on METOP-B. Other work includes the generation of lookup tables and calibration constants.

### **Summary of Accomplishments and Findings**

- AVHRR version of the Pressure layer Fast Algorithm for Atmospheric Transmittances (*PFAAST*) modified to support thermal channels of METOP-B AVHRR.
- Lookup tables for the Daytime Cloud Optical and Microphysical Properties (DCOMP) algorithm generated for METOP-B.
- METOP-B spectral response functions obtained from NOAA and used to generate METOP-B specific constants for CLAVR-x.
- Code tested at CIMSS and compared to METOP-A.
- Code delivered to NESDIS OSPO in January 2013.

### **Publications and Conference Reports**

A CLAVR-x Critical Design Review (CDR) was held on March 13, 2013.

#### **4.2.2. VIIRS Polar Winds**

**CIMSS Task Leaders: Dave Santek, Chris Velden**

**CIMSS Support Scientist: Steve Wanzong, Nick Bearson**

**NOAA Collaborator: Jeff Key**



### NOAA Long Term Goals

- Weather-Ready Nation

### NOAA Strategic Goals

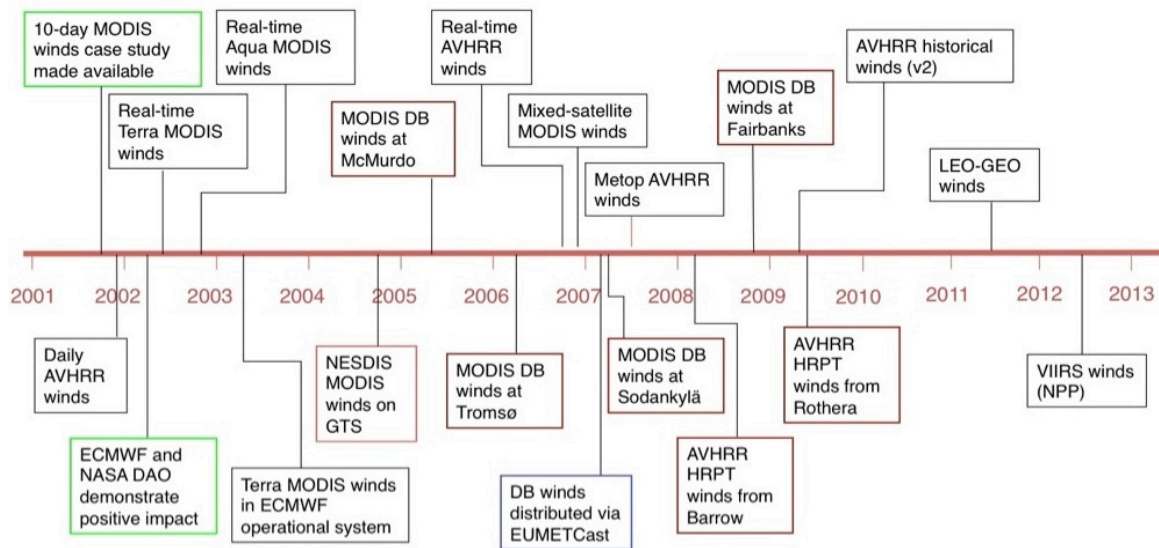
- Serve society's needs for weather and water
- Understand climate variability and change to enhance society's ability to plan and respond
- Provide critical support for the NOAA mission

### CIMSS Research Themes

- Satellite Meteorology Research and Applications
- Satellite Sensors and Techniques

### Proposed Work

Fully automated cloud-drift wind production from GOES became operational in 1996, and wind vectors are routinely used in operational numerical models of the National Centers for Environmental Prediction (NCEP) and other numerical weather prediction (NWP) centers. Winds over the polar regions have been generated with Moderate Resolution Imaging Spectroradiometer (MODIS) instrument on NASA's Terra and Aqua satellites and the Advanced Very High Resolution Radiometer (AVHRR) on NOAA satellites at CIMSS since 2001, and by NESDIS operations since 2005 (MODIS) and later (AVHRR). A timeline of polar wind product development is shown in Figure 4.2.2.1.



**Figure 4.2.2.1.** The polar winds product history, from 2001 to the present.

The objective of this project is to develop a polar wind product using the Visible/Infrared Imager/Radiometer Suite (VIIRS) instrument on the Suomi National Polar-orbiting Partnership satellite (NPP, formerly NPOESS Preparatory Project). NPP was launched 28 October 2011. The product will also be generated with the VIIRS instrument on future Joint Polar Satellite System (JPSS) satellites.

The project Principal Investigator at CIMSS is David Santek. Christopher Velden will consult on the project. Jeff Key, NOAA/NESDIS, works in collaboration with CIMSS scientists and is the NESDIS point of contact for the project.



## Summary of Accomplishments and Findings

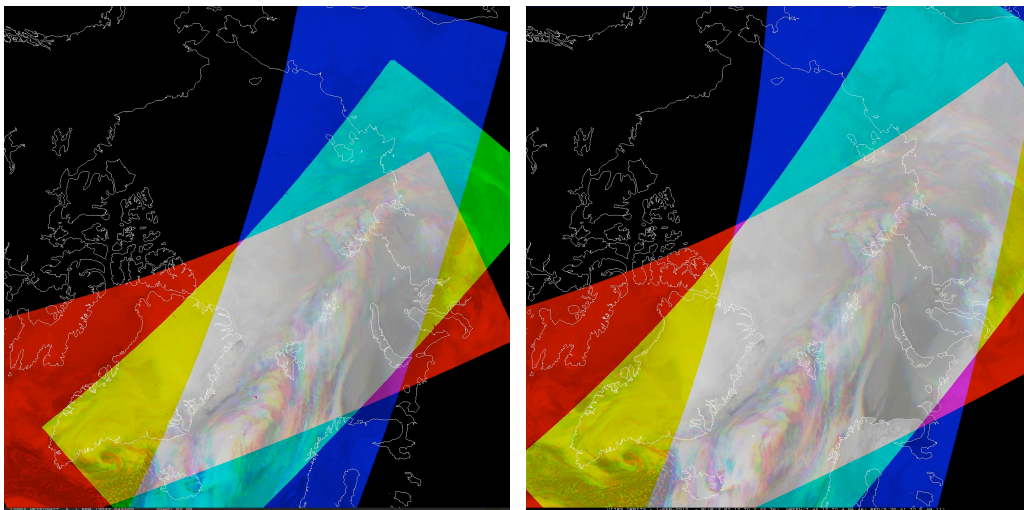
Over the past year we have continued the real-time generation of polar winds products from Terra and Aqua MODIS and AVHRR on NOAA-15, -16, -18, -19 and Metop-A. Metop-B was launched in mid-September 2012 and the AVHRR winds processing at CIMSS was updated in November 2012 to include Metop-B.

The focus of the project, however, is the development of a method to generate winds from VIIRS. VIIRS is a 22-band imaging radiometer that is a cross between MODIS and AVHRR, with some characteristics of the Operational Linescan System (OLS) on Defense Meteorological Satellite Program (DMSP) satellites. It has several unique characteristics that will have an impact on a VIIRS polar winds product. These include:

- Wider swath,
- Higher resolution (750 m for most bands; 375 m for some),
- Constrained pixel growth: better resolution at edge of swath, and
- Day-night band (DNB).

One disadvantage of VIIRS is that, unlike MODIS but similar to AVHRR, it does not have a thermal water vapor band. Therefore, no clear-sky winds can be retrieved.

VIIRS has a wider swath (3000 km) than MODIS (2320 km), so the coverage will be better; the AVHRR swath width is nearly 3000 km. A wider swath means more winds with each orbit triplet. Figure 4.2.2.2 shows the overlap of three orbits, which are needed for wind derivation, for MODIS and VIIRS. The figure illustrates the improved coverage of VIIRS.



**Figure 4.2.2.2.** The gray region represents the overlap in three orbits where the polar winds are derived for MODIS (left) and VIIRS (right).

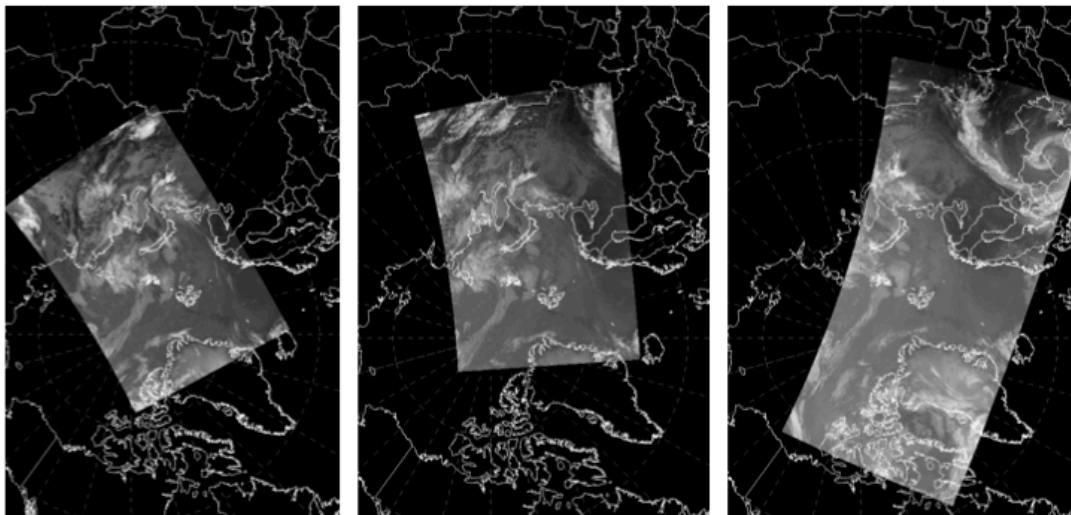
The VIIRS method of aggregating detectors and deleting portions of the scans near the swath edge results in smaller pixels at large scan angles. For thermal bands, VIIRS is  $0.56 \text{ km}^2$  ( $0.75 \times 0.75 \text{ km}$ ) at nadir and  $2.25 \text{ km}^2$  at the edge of the swath ( $0.37 \rightarrow 0.8 \text{ km}$  for imager bands;  $0.74 \rightarrow 0.74 \text{ km}$  for the day-night (DNB) band). In contrast, AVHRR and MODIS are  $1 \text{ km}^2$  at nadir and  $9.7 \text{ km}^2$  at edge of swath. Additionally, VIIRS scan processing reduces the bow-tie effect. The impact of this on a wind product is that tracking features will be better defined, resulting in more good winds toward the edges of the swath.



VIIRS polar winds processing will utilize the new GOES-R Advanced Baseline Imager (ABI) atmospheric motion vector (AMV) algorithm. A significant effort is being devoted to changing the wind retrieval code base. There are some fundamental differences from our traditional procedure. Most importantly, cloud-drift wind heights are determined by using an externally generated cloud height product rather than internal routines. The Clouds from AVHRR Extended (CLAVR-x), NOAA's operational cloud product system for AVHRR, has been adapted for the VIIRS instrument. It employs a naïve Bayesian cloud mask, and uses the GOES-R AWG Cloud Height (ACHA) algorithm. This software has been installed on a CIMSS polar AMV processing computer, and run in demonstration mode.

Many changes to the processing have been made, including tools to convert VIIRS data to a polar stereographic projection, conversion to AREA files, and integration into GEOCAT, all without McIDAS-X libraries.

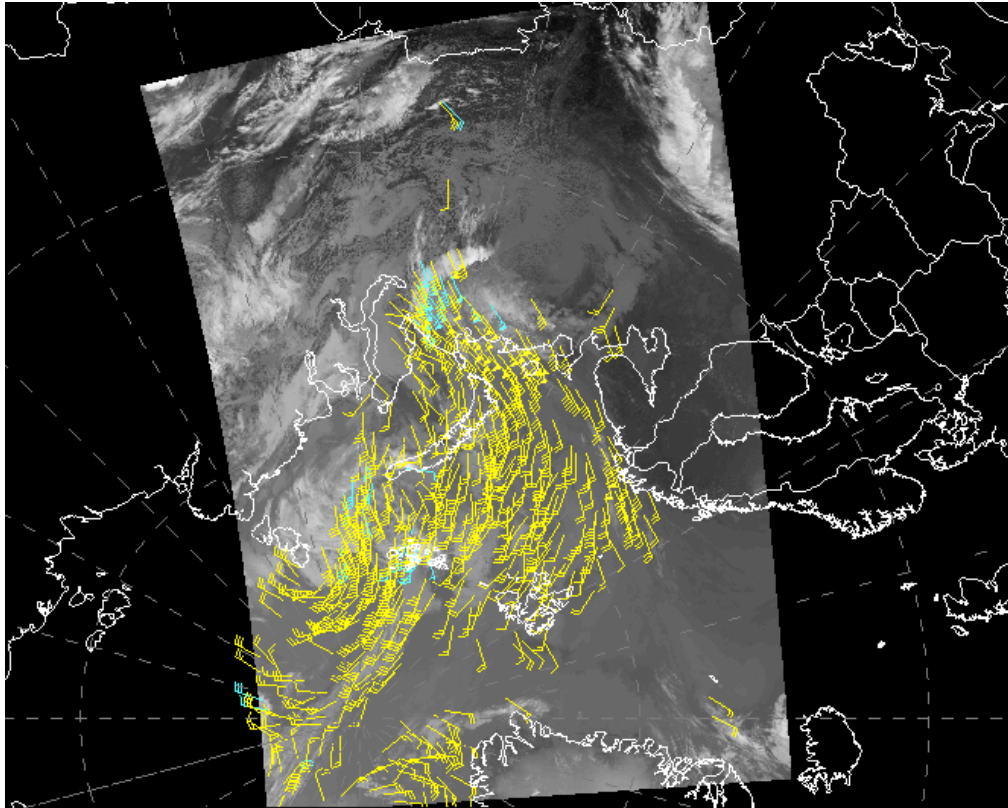
A full VIIRS AMV case consists of combining several 10.763  $\mu\text{m}$  granules (SVM15) into a polar stereographic projection, for three consecutive passes (Figure 4.2.2.3). Each composite image is approximately 100 minutes apart. The latest version of the ABI AMV software has been modified to work with the polar stereographic re-projected VIIRS data; an example of the wind coverage is shown in Figure 4.2.2.4. At this time, the VIIRS processing at CIMSS is only for case studies. One of the next steps is to begin routine production of the VIIRS winds in near-realtime. The VIIRS polar winds product is scheduled to be operational in NESDIS in the fall of 2013.



**Figure 4.2.2.3.** A sequence of three VIIRS arctic composite images from 14 August 2012.

We are also investigating processing the VIIRS data using the heritage winds code (windco) that is used for MODIS and AVHRR. This is being done to:

1. Quantify the differences in the winds processing between the new ABI AMV code and windco; and
2. Evaluate options to produce VIIRS winds at Direct Broadcast (DB) sites, given that windco is currently used to generate DB winds.



**Figure 4.2.2.4.** Arctic AMVs using the VIIRS/ABI processing system for a case on from 14 August 2012. Cyan vectors range from 100 – 400 hPa. Yellow AMVs are below 400 hPa.

We continue to work with numerical weather prediction (NWP) centers regarding product quality, use, and future enhancements. At present, MODIS and AVHRR polar wind products are used operationally by 13 NWP centers in nine countries:

- European Centre for Medium-Range Weather Forecasts (ECMWF);
- NASA Global Modeling and Assimilation Office (GMAO);
- Japan Meteorological Agency (JMA), Arctic only;
- Canadian Meteorological Centre (CMC);
- US Navy, Fleet Numerical Meteorology and Oceanography Center (FNMOC);
- (UK) Met Office;
- Deutscher Wetterdienst (DWD);
- National Centers for Environmental Prediction (NCEP/EMC);
- Météo France;
- Australian Bureau of Meteorology (BoM);
- National Center for Atmospheric Research (NCAR, USA);
- China Meteorological Administration (CMA); and
- Hydrological and Meteorological Centre of Russia (Hydrometcenter).

Many of these centers will include the VIIRS winds in their operational systems after testing.

We have been working closely with the NPOESS Data Exploitation (NDE) integration team. This is a NESDIS/STAR group developing the product generation system for NOAA-unique products such as the VIIRS polar winds. We have contributed to the development of coding standards,



delivery package contents, documentation, ancillary data requirements, and other issues of concern for the operational implementation of our research code.

### **Publications and Conference Reports**

Key, J., R. Dworak, D. Santek, W. Bresky, S. Wanzong, J. Daniels, A. Bailey, C. Velden, H. Qi, P. Keehn, W. Wolf, 2012: Polar Winds from VIIRS, 11<sup>th</sup> International Winds Workshop, Auckland, 20-24 February 2012.

### **4.3. Arctic Composite Satellite Imagery**

**CIMSS Task Leader: Matthew Lazzara**

**CIMSS Support Scientists: Rick Kohrs, Nick Bearson, Jerry Robiadek, & Dave Mikolajczyk**

**NOAA Collaborator: Jeff Key**

#### **NOAA Long Term Goals**

- Weather-Ready Nation

#### **NOAA Strategic Goals**

- Serve society's needs for weather and water
- Support the nation's commerce with information for safe, efficient and environmentally sound transportation
- Provide critical support for the NOAA mission

#### **CIMSS Research Themes**

- Satellite Meteorology Research and Applications
- Satellite Sensors and Techniques

### **Proposed Work**

The creation and routine generation of the Arctic composite satellite imagery has been demonstrated in a National Science Foundation (NSF) Arctic Natural Sciences funded “proof of concept” research project. Arctic composite satellite imagery is the cousin to the Antarctic satellite composite imagery, which has been produced over the Southern Ocean and Antarctic continent for over 20 years as a part of the NSF United States Antarctic Program. These composites include several infrared channels (shortwave, longwave, window, and water vapor), as well as a visible channel (Lazzara et al., 2011; Lazzara et al., 2003). The Arctic composite product covers the Arctic Ocean basin, Northern polar region in the US Arctic and Alaska, as well as Northern Atlantic and Northern Pacific Arctic regions.

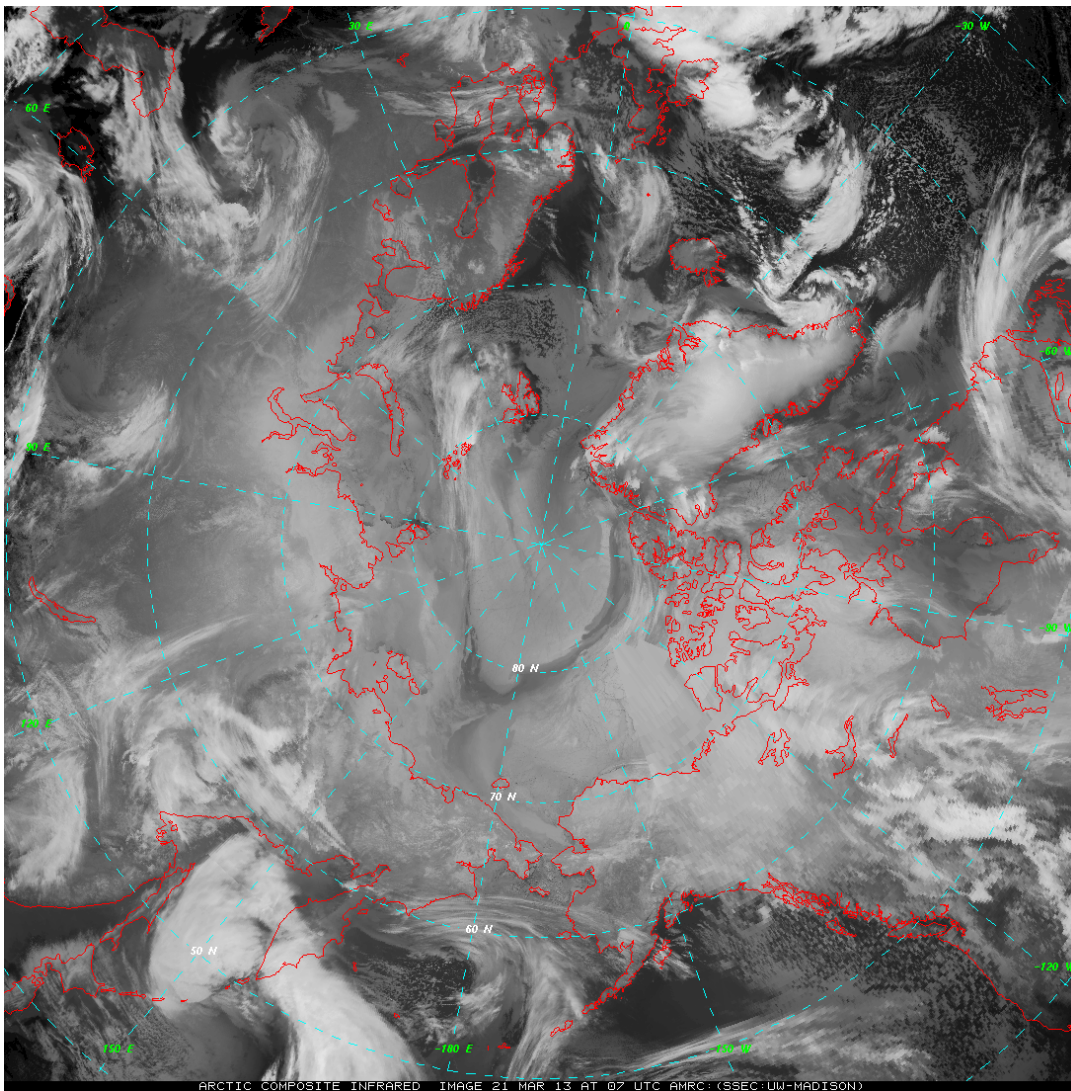
This project aims to transition the Arctic composite satellite generation and products to NOAA operations. The user community for this product includes the Ocean Prediction Center, the Weather Prediction Center (formerly the Hydrometeorological Prediction Center), National Weather Service Alaska, National Ice Center as well as the Satellite Proving Ground for Marine, Precipitation, and Hazardous Weather Applications program. This product aids in improving operational forecasting for the North Pacific and North Atlantic for maritime and aviation operations. Time-lapse imagery and animations assist in the understanding of weather patterns and phenomena, ultimately improving forecasts. With relatively minor enhancements, the Arctic composite satellite product meets users' requested needs.

### **Summary of Accomplishments and Findings**

This product improves upon existing operational shortfalls in current NOAA mosaic imagery, as the currently available composite imagery is a daily multi-channel polar-orbiting-only satellite



product at a resolution of 36 kilometers (km) at the poles. The product developed here utilizes all available geostationary and polar orbiting satellite imagery, providing the best possible imagery at a higher spatial (4 km nominal) and temporal resolution (1 hourly) (See Figure 4.3.1). A successful generation system has been set up in the first year of this activity, including the specific computer configuration required. Continued development of the Arctic composite product has taken place, especially tailoring it to meet users' needs. This includes setting up projection and navigation as well as testing a high spatial resolution composite at 4 kilometers (an improvement over the original NSF composite imagery, which was set at 5 km nominal resolution). These improved products are being provided to end-users so they can evaluate the Arctic composite satellite imagery via Local Data Manager (LDM) transfer. Additionally, composite imagery is made available on the Web at <http://arctic.ssec.wisc.edu/>



**Figure 4.3.1.** An example Arctic composite infrared image from 21 March 2013 at 7 UTC depicting the good coverage possible over the entire Arctic basin from the mosaic of polar orbiting and geostationary satellite observation.





## Publications and Conference Reports

Kohrs R., M. Lazzara, D. Santek, N. Bearson, S. Knuth, J. Robaidek, and D. Milojaczyk, In preparation. Global Satellite Composites – 20 Years of Evolution, Atmospheric Research, in preparation.

Lazzara, M.A., D.A. Santek, R.A. Kohrs, B.T. Hoover, and D.E. Mikolajczyk, 2013: Arctic and Antarctic Satellite Composites: Construction and Applications. NOAA Satellite Conference 2013, College Park, MD.

## References

Lazzara, M.A., A. Coletti, B.L. Diedrich, 2011: The possibilities of polar meteorology, environmental remote sensing, communications and space weather applications from Artificial Lagrange Orbit. *J. Adv. Space Res.*, **48**, 1880-1889, doi:10.1016/j.asr.2011.04.026.

Lazzara, M.A., L.M. Keller, C.R. Stearns, J.E. Thom, and G.A. Wiedner, 2003: Antarctic Satellite Meteorology: Applications for Weather Forecasting. *Mon. Wea. Rev.*, **131**, 371-383.

## 5. Cloud Products Update for NCEP and NWS Alaska (G-PSDI)

**CIMSS Task Leaders: Anthony Wimmers**

**NOAA Collaborators: Andrew Heidinger**

**NOAA Long Term Goals**

- Weather-Ready Nation

**NOAA Strategic Goals**

- Serve society's needs for weather and water
- Provide critical support for the NOAA mission

**CIMSS Research Themes**

- Satellite Meteorology Research and Applications

### Proposed Work

The Clouds from AVHRR Extended (CLAVR-x) and GOES Surface and Insolation Project (GSIP) are existing operational systems serving data to the National Weather Service (NWS) National Centers for Environmental Prediction (NCEP) and Weather Forecast Offices (WFO). The resolution of the datasets generated today were determined several years ago, and increases in model resolution warrant an increase in the resolution of satellite products served to NCEP. The hdf4 and binary formats provided today are also no longer optimal for NWS. In addition to spatial resolution, the value of higher vertical resolution cloud product imagery is increasing in NWS WFOs. The lack of consistent spatial and temporal coverage at higher latitudes has hampered the use of this information by forecasters, and so the Alaskan WFO has requested composites of cloud height information to assist in their aviation and general forecast duties. This project updates CLAVR-x and GSIP to accomplish this mission and develop compositing codes to integrate these new data in the most readily usable fashion.

Since the development of the CLAVR-x and GSIP programs, the NESDIS/STAR Algorithm Implementation Team (AIT) has developed tools to perform the data formatting and gridding needed for the GOES-R program. These tools have been funded by PSDI and are already mature. The goal for this project is to remap the CLAVR-x level-2 products into the requested NCEP model grid. These remapped data will then feed into the existing AIT tools for conversion into formats expected by NCEP. We plan on using the GSIP mapping tools for this, which are an open



source toolkit that will allow the CLAVR-x level-2 files to be converted from swath projection to the NCEP model grids. Most of this work will be done by NESDIS/STAR but CIMSS does participate in the testing of this mapping procedure. CIMSS will make the modifications of the CLAVR-x and GSIP to make the pixel-level swath projection files that are the starting point in this process.

For the data compositing component of this project, we proposed this past year to show a preliminary application of existing image morphing techniques (Wimmers and Velden, 2010) to AVHRR 11 mm brightness temperatures (the dominant channel in cloud products) at the poles, in order to demonstrate the utility of existing algorithms to produce composites of cloud products at high latitudes. We also set an objective to identify the most suitable optical flow algorithm for polar cloud product combination, in order to apply the most accurate possible transformation between retrieved data in the composite product.

### **Summary of Accomplishments and Findings**

The modifications of the CLAVR-x and GSIP codes to generate pixel-level hdf output are complete. Both these modifications are being transitioned in operations in FY13. CLAVR-x modifications include the addition of the needed parameters to the existing pixel-level output. Although GSIP was never designed to make pixel-level output, this project has successfully modified GSIP to generate output to CLAVR-x. In addition, the GSIP mapping tools have been implemented and tested at NESDIS STAR. The images below (Figure 5.1) show pixel-level 11 mm brightness temperature output from NOAA-19 AVHRR from Gilmore Creek, Alaska and GOES-West at roughly 23Z on April 8, 2013.

In the data morphing/compositing component, we have successfully run and demonstrated a weighted and blended composite of 11 mm brightness temperatures from NOAA-15, 16, 18, 19 and Metop-A AVHRR (Figure 5.2). This shows that the existing data blending/compositing code is well-suited to the polar domain, and that the rapid refresh of data at high latitudes compensates for the fairly quick generation of new information in the cloud patterns. Visualizing the product in 30-minute resolution animations demonstrated this point especially well (Wimmers and Heidinger, 2012).

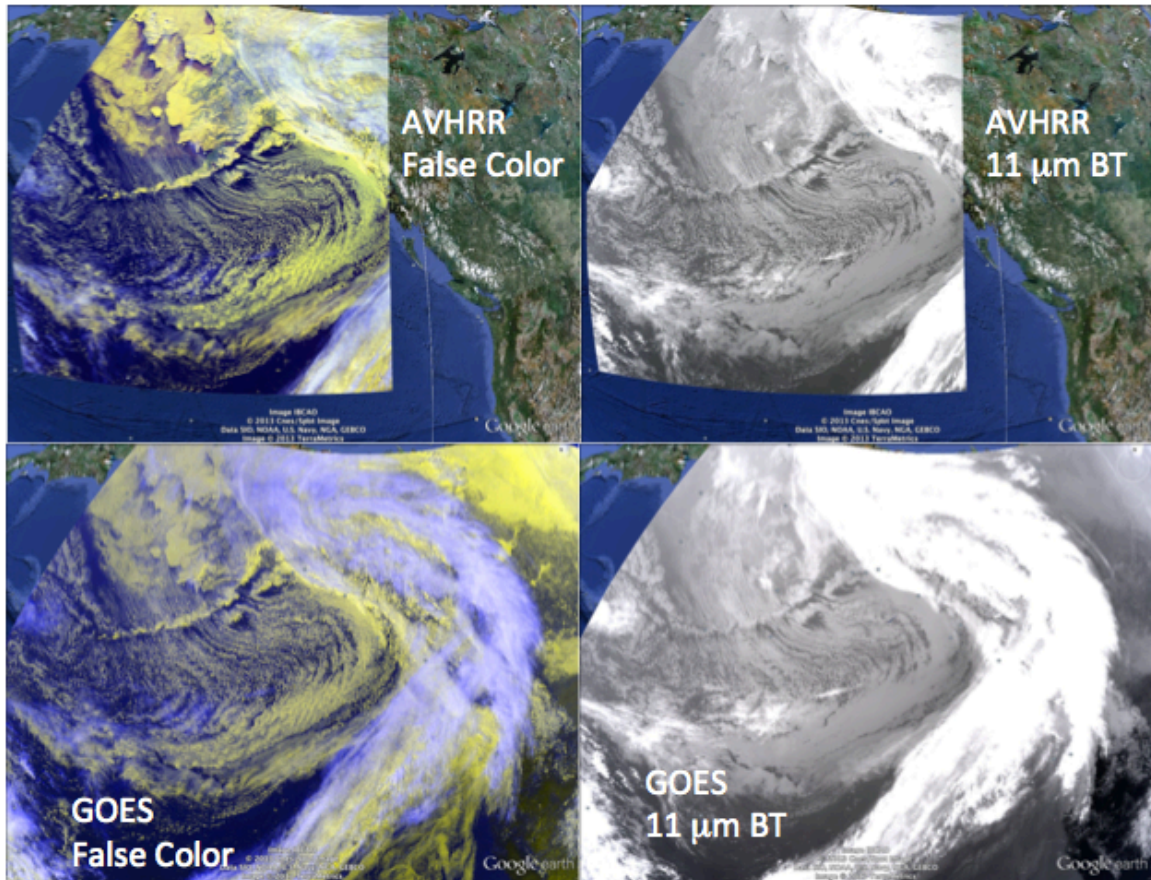
We have also successfully tested and calibrated a robust optical flow algorithm that will be used to bring an advective component to the composited polar swaths for additional accuracy in the data blending process. Figure 5.3 shows this process at work for an AVHRR image pair – the derived product is an image at an interpolated time that preserves object fidelity and edge sharpness, such as the cloud gaps and frontal boundaries. (By contrast, a simple temporal interpolation would oversmooth the cloud texture and show an awkward double-exposure artifact at the frontal boundary.)

### **Reference**

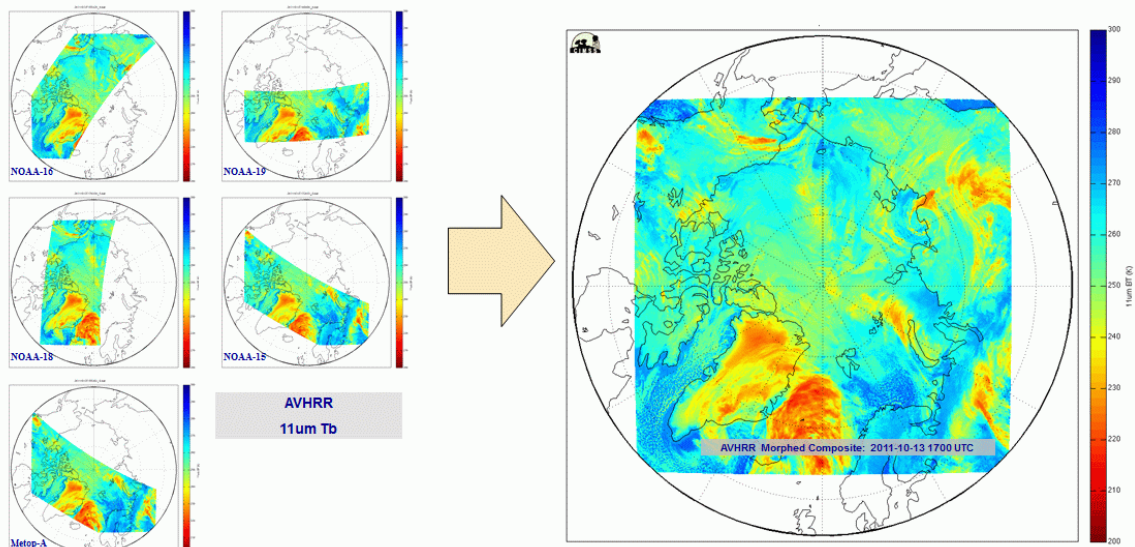
Wimmers, A. J. and C. S. Velden, Objectively determining the rotational center of tropical cyclones in passive microwave satellite imagery, *J. Appl. Meteor.*, 49, 2010–2034, 2010.

### **Publications and Conference Reports**

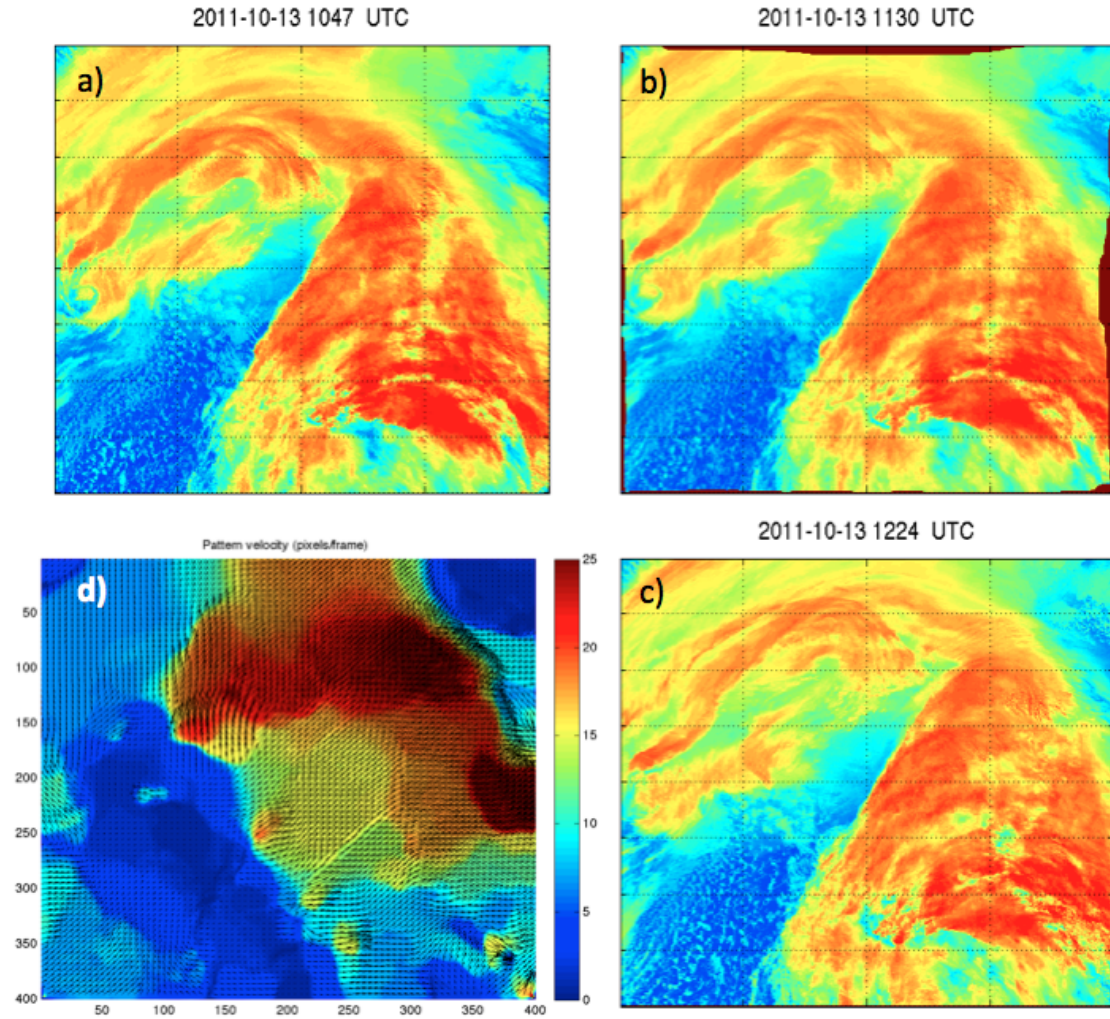
Wimmers, A. J. and A. Heidinger, Morphing polar-orbiter imagery of cloud products for improved visualization and forecasting, National Weather Association Annual Meeting, Madison, Wisconsin, 2012.



**Figure 5.1.** Pixel-level products for AVHRR (top row) and GOES (bottom row) generated by the new GSIP tools and displayed in Google Earth.



**Figure 5.2.** Example of image morphing/compositing applied to AVHRR HRPT data over the Arctic. As the data are aligned between successive overpasses and appropriately weighted, the resulting composite is nearly seamless at the edges of the satellite data swaths.



**Figure 5.3.** Image transition using robust optical flow algorithm, from AVHRR imagery over a domain the size of Alaska. The initial image is from 2011-10-13 1047 UTC (a), and the final image is 2011-10-13 1224 UTC (c). The purely synthetic image in the middle of this 97-minute data gap is produced for 2011-10-13 1130 UTC (b), using the optical flow field shown in (d) along with temporal weighting.

## 6. CIMSS Infrastructure Support for Product Development, Demonstration and Operational Transition (Ground Systems)

**CIMSS Task Leaders: Steve Ackerman, Tom Achtor**

**NOAA Collaborator: Jeff Key**

**NOAA Strategic Goals**

- Provide critical support for the NOAA mission

**CIMSS Research Themes**

- Weather and Water



### Proposed Work

This proposal is for the acquisition and development of a high-end computing system with large storage capacity that will benefit funded projects for future NOAA satellites, particularly the Geostationary Operational Environmental Satellite-R (GOES-R) and the Joint Polar Satellite System (JPSS). CIMSS seeks to develop a local community computing resource rather than continuing to rely on individual systems belonging to specific projects.

### Summary of Accomplishments and Findings

The budget request for computer systems is given in the table below. The majority of the funds were used to purchase computer servers, processors and mass storage, with some funds devoted to system software development and implementation. The computers included in this budget are identical to servers that we already have in service and the software will replicated from an existing cluster to minimize setup and maintenance expenses.

Component	Unit Cost	Qty	Total
Storage Servers	\$10,941	3	\$32,823
Compute Server	\$12,483	1	\$12,483
Infiniband Cards	\$454	4	\$1,816
Total			\$47,122

The remaining funds are used as labor costs to integrate the hardware into the existing high speed Infiniband network and setup the cluster computing environment.

## 7. Monitoring and Incorporating the Stray Light Correction Process into GOES Imager and Derived Products

**CIMSS Task Leader: Mathew M. Gunshor**

**CIMSS Support Scientists: Anthony J. Schreiner, James P. Nelson III**

**NOAA Collaborator: Timothy J. Schmit**

### NOAA Long Term Goals

- Weather-Ready Nation

### NOAA Strategic Goals

- Serve society's needs for weather and water
- Provide critical support for the NOAA mission

### CIMSS Research Themes

- Satellite Meteorology Research and Applications
- Satellite Sensors and Techniques

### Proposed Work

Historically, twice per year, during the spring and autumnal equinox GOES Imager and Sounder radiance data are intermittently not available for two reasons. First, the Earth comes between the Sun and the Geostationary Operational Environment Satellite (GOES) solar cell platform during the “local midnight” period and radiance data are not recorded or transmitted. Second, also during the same time (“local midnight”) “leakage” of solar radiation within the GOES telescope occurs, thus significantly contaminating both the visible and the short wave IR bands of the Imager and Sounder instruments. For GOES-East this “local midnight” is centered on approximately 06:00



UTC, while for GOES-West it is centered on 10:00 UTC. The total impact of this is a data loss equivalent to six days over the course of one year.

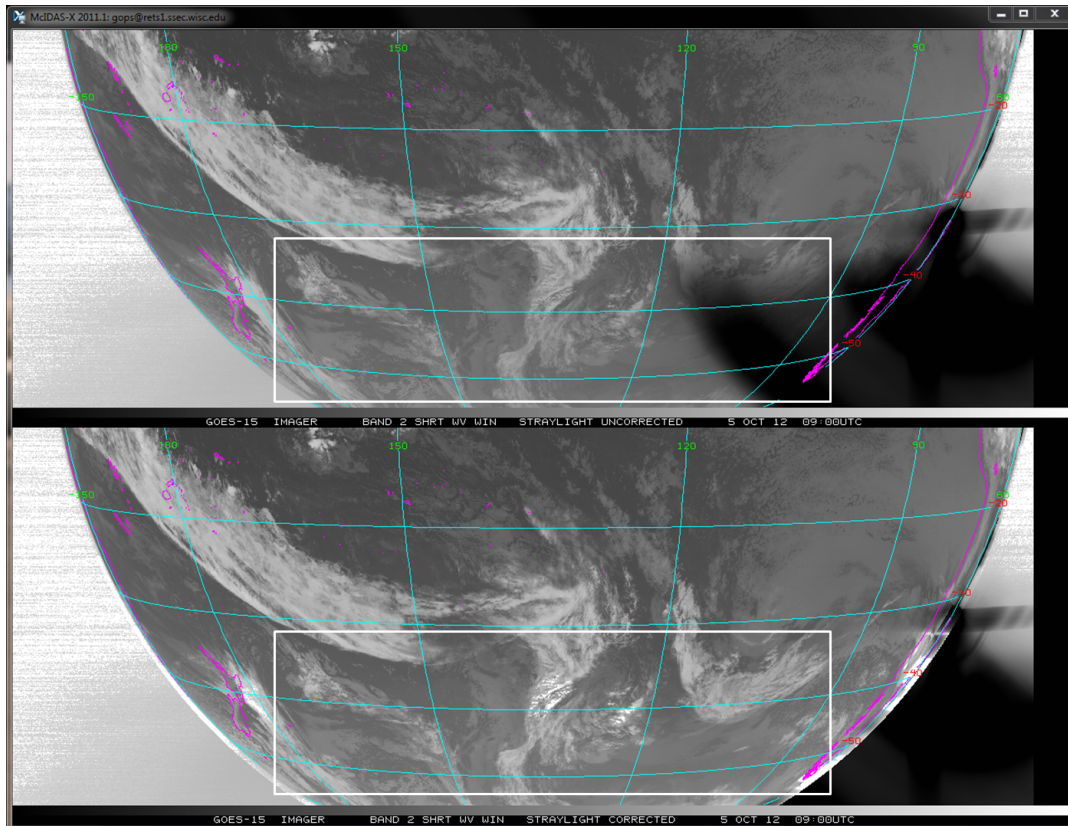
With the launch of the three latest versions of the GOES platforms, GOES-N (13), -O (14), and -P (15), significant strides have been taken to alleviate both of these shortcomings (Hillger and Schmit, 2011). Loss of GOES radiance data due to a lack of electrical power to the instruments has been assuaged with the inclusion of longer lasting batteries on board the GOES platform. (NASA, 2009) “Leakage” of solar radiation or “Stray Light” (SL) has required some ground station pre-processing of the data transmitted from the GOES before it is re-transmitted to GOES users via GVAR. The algorithm was developed by ITT and implemented by NOAA/NESDIS. As a result of these two modifications, more continuous coverage from the GOES platforms is now a reality independent of the time of year. This allows for improved monitoring of springtime storms and land-falling hurricanes.

Improved temporal coverage as a result of the first modification (more powerful batteries) is straight forward, and the fruit of this enhancement was realized immediately. More continuous data coverage resulting from SLC would require monitoring, however. This would require two steps. First, inspection of the quality of re-transmitted and “corrected” imagery would be necessary in order to determine its physical “correctness.” Secondly, as radiance information from the GOES Imager is used in the determination of quantitative products (e.g., Cloud Top Pressure, and Clear Sky Brightness Temperature), monitoring and software development would also be required. Therefore, in conjunction with the spring 2012 test of the SLC for GOES-13 Imager, it was proposed to undertake the two tasks described above.

### **Summary of Accomplishments and Findings**

The spring and autumnal equinox seasons were monitored for GOES-13 and GOES-15 for spring 2012, fall 2012, and spring 2013. The stray light correction (SLC) provides better data than the eclipse data would be without it, but it is not a perfect solution. Generally speaking, it appears that the SLC allows dissemination of GOES data that were blocked historically, but that the data may not all be usable even now. Figure 7.1 demonstrates how stray light affects an image quantitatively. An example of GOES-15 cloud top pressure is shown in Figure 7.2 and shows how stray light affects products. Unaltered GOES-15 data were provided to CIMSS by NESDIS for this purpose.

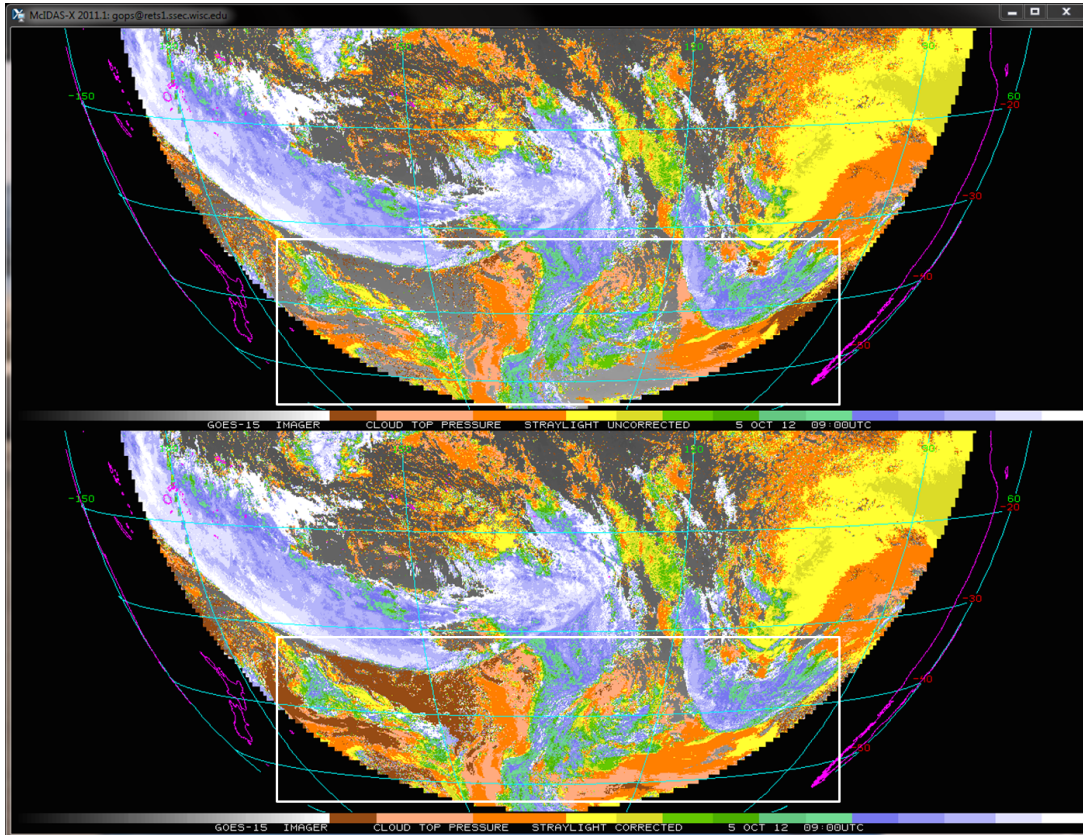
The uncorrected data (top of Figure 7.2) miss detecting the low clouds around the southeastern portion of the white box, but correctly leave part of the western half of that white box clear. In the SLC data (bottom of Figure 7.2) the low cloud in the southeastern portion of the box are detected but the clear area on the western half of the box are now marked incorrectly as low cloud.



**Figure 7.1.** GOES-15 Imager band 2 (3.9 micrometer) at 9:00 UTC on 5 October 2012. Top panel has uncorrected data with stray-light apparent affecting the southeast corner of the image. Bottom panel shows how the stray light correction (mostly) removes the effects of stray light on the earth viewing portion of the image.

The milestones met for 2012 include:

- Implementing a subroutine/function to read the McIDAS area line prefix header in spring 2012.
- Comparing “corrected” versus “uncorrected” Stray Light with respect to quantitatively derived GOES-13 Imager products from spring of 2012 data.
- Making available subroutines to NOAA/NESDIS for incorporation into operational processing algorithms.
- Testing sample corrected versus uncorrected GOES-15 Imager radiance information for fall 2013 data.
- Updating subroutines for possible incorporation into operational algorithms at the end of fall 2012.
  - Now providing more information about how the stray light correction is applied to an image.
- Monitoring fall 2012 fall eclipse season.



**Figure 7.2.** GOES-15 Imager Cloud Top Pressure (CTP) at 9:00 UTC on 5 October 2012. Top panel is generated with uncorrected data. Bottom panel displays CTP using stray light corrected data. The white box outlines of areas of interest where stray light correction helped in portions of the image to detect low cloud, but then caused the algorithm to incorrectly label some clear areas as having low cloud.

## References

Hillger, D.W., and T.J. Schmit, 2011: Imager and Sounder Radiance and Product Validation for the GOES-15 Science Test, NOAA Technical Report, NESDIS 141, (November), 101 pp.

## 8. CIMSS Participation in the GOES-R Algorithm Working Group (AWG) for 2012

### 8.1. Real-time Proxy Framework Support: CRTM Component and Validation

**CIMSS Task Leaders: Tom Greenwald and Allen Huang**

**CIMSS Support Scientists: Jason Otkin, Todd Schaack, Jim Davies, Kaba Bah, Marek Rogal, Eva Borbas**

**NOAA Collaborator: Brad Pierce**

**NOAA Long Term Goals**

- Weather-Ready Nation

**NOAA Strategic Goals**

- Serve society's needs for weather and water

**CIMSS Research Themes**

- Satellite Meteorology Research and Applications





- Environmental Models and Data Assimilation

### Proposed Work

This project will generate synthetic ABI data in near-real-time over CONUS using the Joint Center for Satellite Data Assimilation (JCSDA) Community Radiative Transfer Model (CRTM) and model output from the WRF-Chem/RAQMS Real-time Proxy Framework (a related project led by Brad Pierce). Data will be provided to the Algorithm Integration Team (AIT) and Proving Ground partners for testing all GOES-R algorithms over a greater range of conditions than is possible with current proxy datasets. These data will also be used to support GRAFIIR through Government-specified waivers. For ensuring reliable proxy ABI data, we will develop near-real-time validation capabilities based on MODIS and GOES radiances/retrievals obtained from direct broadcast data collected at SSEC.

### Summary of Accomplishments and Findings

- An automated system was developed to generate simulated 16-band ABI imagery in near-real-time at 8km resolution over CONUS (as defined in the GOES-R Product Users' Guide, or PUG) using WRF-Chem model runs and the CRTM V2.1 on NOAA's S4 supercomputer at CIMSS. RAQMS forecasts are used to initialize chemistry in the WRF-Chem model and WF-ABA wildfire detection data are used to initialize fire emissions in the model.
- Significant improvements were made to the land surface radiative properties in the simulated imagery using 16-day composite Bi-directional Reflectance Distribution Function (BRDF) data derived from MODIS data collected by SSEC's direct broadcast system and monthly mean 8-km IR land surface emissivity datasets over CONUS derived from the UW-Madison/CIMSS high spectral resolution global IR land surface emissivity database.
- A Web site was created to view our simulated 16-band ABI imagery in near-real-time to support Proving Ground activities: [http://cimss.ssec.wisc.edu/goes\\_r/proving-ground/wrf\\_chem\\_abi/wrf\\_chem\\_abi.html](http://cimss.ssec.wisc.edu/goes_r/proving-ground/wrf_chem_abi/wrf_chem_abi.html) (see Figure 8.1.1).
- A procedure was developed for remapping the simulated radiance data from the model grid into the 2 km Fixed Grid Format (FGF), in compliance with PUG conventions, and converting them to CF compliant netCDF-4 files and eventually to GOES-R Re-Broadcast (GRB) files for distribution. This work was done in close collaboration with the AWG Visualization/Imagery team.
- Simulated 16-band ABI imagery data (i.e., GRB files) are currently being delivered to the AIT in near-real-time for testing ABI data throughput and retrieval algorithms.
- Support was added to GEOCAT to read the netCDF-4 GRB files. This work was done in collaboration with Graeme Martin who is a member of the AIT technical support team at CIMSS.
- An improved F90/95 interface for the WRF-Chem model output and CRTM was nearly completed that will provide better efficiency and more flexibility than the current interface.
- An automated system was developed to validate the simulated ABI radiances and selected Baseline products using MODIS products and GOES-13 Sounder data and derived products collected in real-time by SSEC's direct broadcast system. The validation system currently has a lag time of about 2 days but will be made to run with shorter latency in next year's effort.
  - An automated procedure was built to ingest MODIS direct broadcast products (cloud top pressure/temperature, cloud visible optical thickness, and cloud fraction) and compare them to similar products derived from WRF-Chem model



- output. To display the results we adapted our existing IDL code for near-real-time processing.
- GOES-13 sounder data and products (10 km spatial resolution) are collected in real-time and converted to netCDF using McIDAS-X. Products include cloud mask, total precipitable water (TPW), convective available potential energy (CAPE), lifted index (LI), and cloud top pressure (CTP). These files are then remapped to the 2-km FGF netCDF files for direct comparison to the simulated data.
  - Simulated ABI radiance data are being validated using GOES-13 sounder observations. Statistics between the datasets are monitored daily using Glance, a Python software tool developed at CIMSS, and displayed on our Web site at [http://cimss.ssec.wisc.edu/goes\\_r/proving-ground/crtm\\_goes\\_comps/](http://cimss.ssec.wisc.edu/goes_r/proving-ground/crtm_goes_comps/). Automated IDL code is then used to graphically display the results as difference maps, probability distribution functions, scatter plots, and time series in clear and cloudy conditions. A Web site to view these results is available at [http://cimss.ssec.wisc.edu/goes\\_r/proving-ground/wrf\\_chem\\_abi/ABI-VAL/index2.html](http://cimss.ssec.wisc.edu/goes_r/proving-ground/wrf_chem_abi/ABI-VAL/index2.html).
  - Simulated ABI baseline products produced from GEOCAT (e.g., cloud top pressure/height, TPW, LI, CAPE) are just beginning to be validated. One example is shown in Figure 8.1.2. Preparation of the cloud products was done in collaboration with Andy Heidinger, AWG Cloud lead.
  - The validation system was instrumental in identifying a number of issues with the CRTM and the WRF-Chem model through comparisons of simulated GOES-13 sounder data with observations.
    - A significant bias was identified for the surface shortwave reflectivity in the CRTM for the Lambertian BRDF. To solve this problem, the BRDF was simplified as an albedo. This change was eventually included in the official CRTM V2.1 release.
    - Another issue concerned the shortwave reflectance calculation in CRTM V2.1 when using the user-defined surface emissivity and surface reflectance option. We implemented a fix and submitted a ticket to the CRTM development team.
    - Two major issues were discovered in the CRTM's calculation of 3.9  $\mu\text{m}$  brightness temperatures. The first related to the BRDF calculation in rough seas. We implemented a temporary fix in our processing stream and submitted a ticket regarding the problem to the CRTM developers. Second, the CRTM excluded the solar reflection term for 3.9  $\mu\text{m}$  calculations in cloudy conditions during the daytime. A temporary fix was made and another ticket was submitted to the CRTM developers.
    - A related issue involved extremely large differences ( $> 50 \text{ K}$ ) that were found between the simulated and observed 3.9  $\mu\text{m}$  brightness temperatures in cloudy regions even when solar reflection was accounted for. It turned out the microphysics scheme used in our WRF-Chem model runs (i.e., WSM6) generated far too much cloud ice. Further testing with another parameterization, the Thompson scheme, greatly improved the agreement with the observations. This scheme will be used in future WRF-Chem runs.

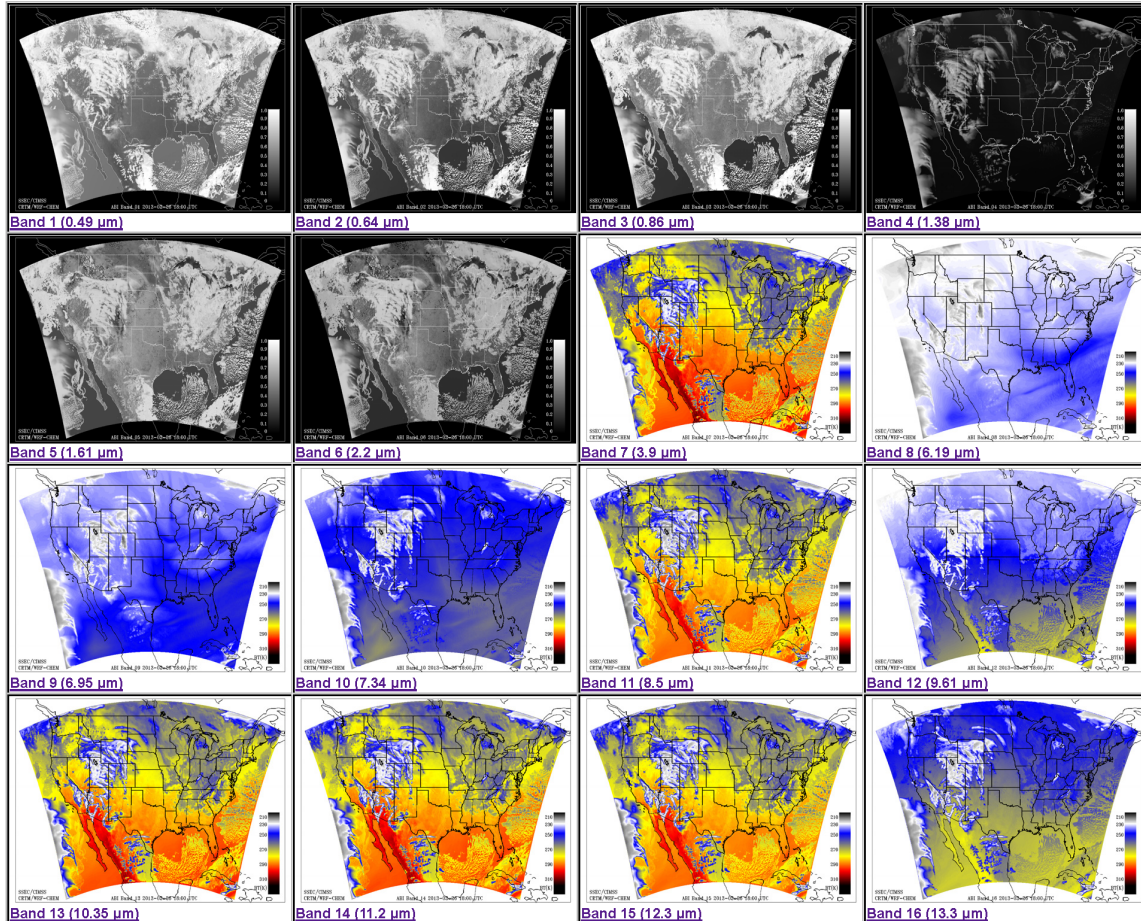


## GOES-R Activities at CIMSS / SSEC

» Home » Proving Ground

### GOES-R Proving Ground UW/CIMSS WRF Chem Simulated ABI Bands 1-16

Click on band for time loop.



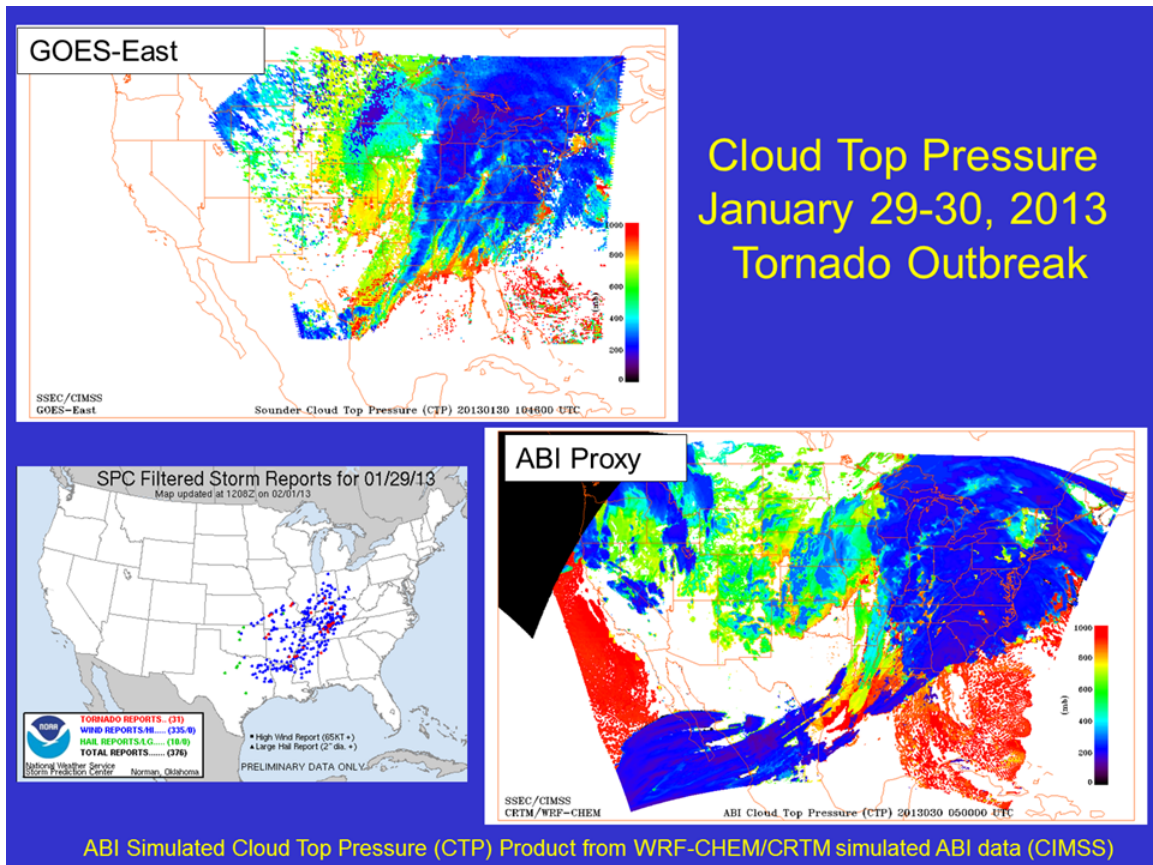
**Figure 8.1.1.** GOES-R simulated ABI imagery available through our Web site.

#### Publications and Conference Reports

Ding, S., P. Yang, B. A. Baum, A. Heidinger, and T. Greenwald, 2013: Development of a GOES-R Advanced Baseline Imager solar channel radiance simulator for ice clouds. *J. Applied Meteor. and Clim.*, 52, 872-888

Greenwald, T., B. Pierce, J. Otkin, T. Schaack, J. Davies, E. Borbas, M. Rogal, K. Bah, G. Martin, J. Nelson, J. Sieglaff, W. Straka, and H.-L. Huang, 2013: Near-real-time simulated ABI imagery for user readiness, retrieval algorithm evaluation and model verification, 93<sup>rd</sup> American Meteorological Society Annual Meeting, Ninth Annual Symposium on Future Operational Environmental Satellite Systems, 5-10 January, Austin, Texas.

Rogal, M., K. Bah, T. Greenwald, B. Pierce, A. Lenzen, J. Nelson, J. Otkin, T. Schaack, J. Davies, E. Borbas, J. Sieglaff, and H.-L. Huang, 2013: Near-real-time validation of simulated GOES-R ABI radiances and derived products using the WRF-Chem model forecast over CONUS for all 16 ABI bands, NOAA Satellite Science Week, virtual meeting, 18-22 March.



**Figure 8.1.2.** Comparison of GOES-13 sounder cloud top pressure observations and cloud top pressure retrieved from simulated ABI radiance data using the ABI cloud top height algorithm for the tornado outbreak of January 29-30, 2013.

## 8.2. GOES-R Analysis Facility Instrument for Impacts on Requirements (GRAFIIR)

**CIMSS Task Leaders: Allen Huang, Mathew M. Gunshor**

**CIMSS Support Scientists: Hong Zhang, Eva Schiffer, Erik Olson**

**NOAA Collaborator: Timothy J. Schmit (ASPB/STAR/NESDIS)**

**NOAA Long Term Goals**

- Weather-Ready Nation

**NOAA Strategic Goals**

- Serve society's needs for weather and water
- Provide critical support for the NOAA mission

**CIMSS Research Themes**

- Satellite Meteorology Research and Applications
- Satellite Sensors and Techniques

**Proposed Work**

The proposed activities for 2012 were the following:

- Continue to expand features of GRAFIIR to model ABI instrument effects:
  - Potentially interface with ITT to supply "pure" simulated L1B ABI data files and



receive back perturbed L1B data files that have been put through the vendor's instrument model;

- Improve analysis function of GRAFIIR to include other ABI products to extend the study of sensor impacts on products not already analyzed. This would likely require that CIMSS have a working version of the AIT Framework with all algorithms included;
- Provide support and datasets to assist application team members in evaluating and testing of their product algorithms;
- Interface with the Integrated Modeling Working Group (IMWG), or a similar entity, concerning the government's waiver response plan or to respond to a particular waiver request;
- Respond to proposed changes in ABI instrument specifications to assess their potential effects on products. (ABI waiver analysis):
  - Waiver response reports contain the following elements:
    - Description of the proxy data used and how those data were adjusted to reflect the effects of the instrument waiver,
    - Description of the analysis techniques, such as an analysis using AWG algorithms to generate pertinent products,
    - Results with statistical analysis and if possible (and necessary) an assessment of the impacts on product quality (ability to meet product accuracy and precision specifications), and
    - Summary and possible recommendations from the pertinent AWG teams/chairs, including the GRAFIIR team;
- Continue to expand and improve the GRAFIIR analysis tool Glance:
  - GUI format easier to use for beginning users,
  - New data formats AWG teams plan to use in validation,
  - Expanded capability to analyze current GOES products for validation, and
  - Respond to AWG science team requests to meet the specific needs of their algorithms; and
- Continue to interface with visualization team and AWG science teams to better utilize visualization tools.

Milestones for this year were to provide 4 (once per quarter) updates to Glance and to address any and all waiver/deviation requests that came through.

### **Summary of Accomplishments and Findings**

The primary diagnostic tool, called Glance, was expanded and improved throughout the project year. Updates of Glance were provided to the AWG's Algorithm Integration Team (AIT) 4 times during the year (at the end of each project quarter). The GRAFIIR team continues to consult with the Integrated Modeling Working Group (IMWG) on behalf of or in conjunction with the AWG. There were three ABI waivers/deviations this year. The three bands affected were the 0.865, 1.378, and 12.3 micrometer bands.

The 0.865 micrometer band issue involved an overshoot issue where scanning from darker to brighter pixels can cause an artificial bump in brightness to the brighter pixel. This issue could affect several products including Imagery, Aerosols, Insolation, and Snow. It would also affect vegetation index, which is a future capability product. MODIS data were used to simulate the affect and generate products (which were generated in this case by the GOES-R AWG Aerosol team).



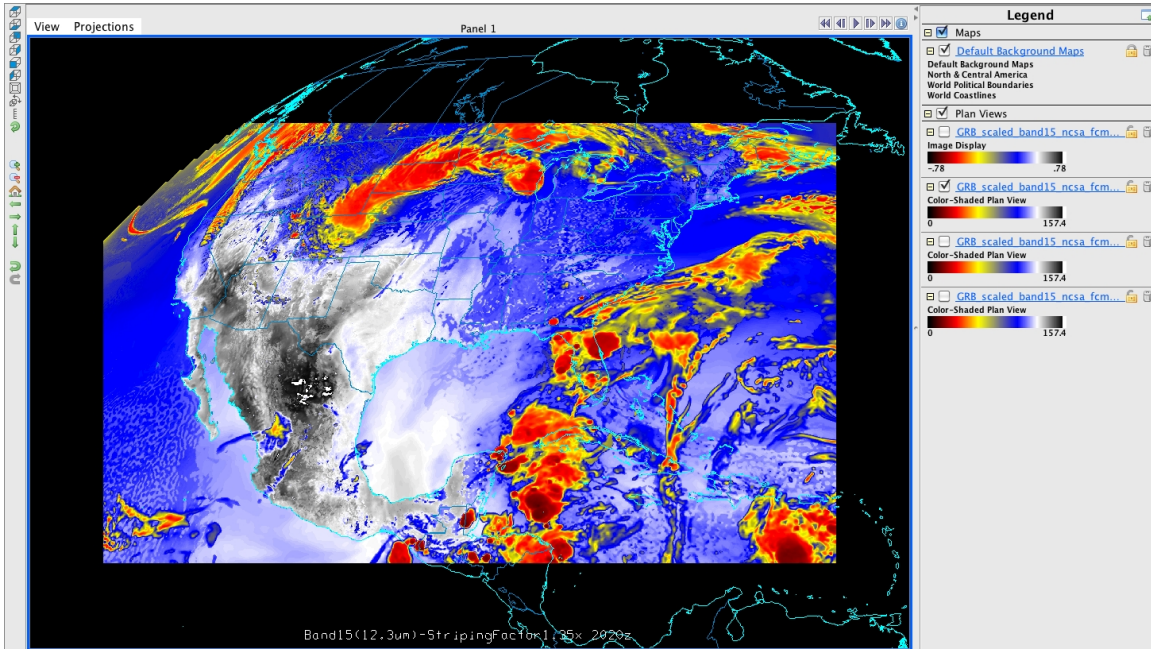
The 1.378 micrometer band issue involved a spectral response function (SRF) being slightly out of the specified envelope. It was deemed this would not have a negative impact on product generation. The primary concern with the SRFs is near-precise knowledge of their shape and spectral location. They can be slightly out of the envelope and not cause a problem, as long as they do not cross a threshold such that a spectral component is added or completely missed (which would require gross errors outside of the specified envelope).

The 12.3 micrometer band issue involved striping caused by a noisy detector. The products analyzed for this were the clouds and soundings algorithms. This issue was replicated in simulated CONUS data for 4 June 2005 provided by the AWG proxy data team. Every 100<sup>th</sup> line had noise added to it equal to the amount predicted by the instrument vendor for the bad detector. The recommendation after analysis was that this issue would not affect products enough to cause them to be unable to meet their own specifications for accuracy, though the effect would be noticed. It was also recommended that a smarter remapping process would be able to mitigate the impact. After the initial analysis and response, the exercise was repeated using the near-real-time WRF-CHEM simulated data, to be sure those data can easily be used in future waiver analyses.

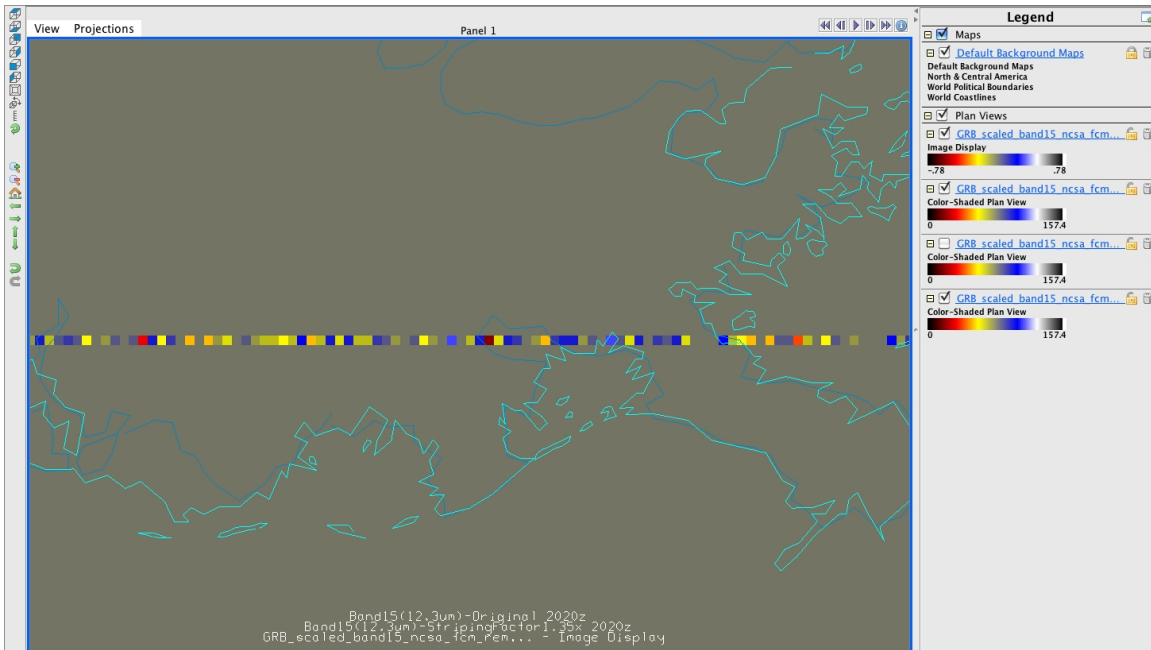
Some of the specific updates to Glance this past year include, but are not limited to: ability to generate statistics on a single file (not just a difference between 2 files), new statistics added, easier installation, displaying category data (such as cloud mask categories), filters for reversing 2D data, multiple plotting features added to GUI version, special handling for AWIPS data, and the ability to restrict ranges in histograms. Glance was developed for GOES-R but has found its way into the JPSS program as well.

A new test server was set up for GRAFIIR to replace the aging one. This new server allows faster processing, more jobs run simultaneously, and larger datasets to be analyzed at once. This server is used to run Glance and GEOCAT for ABI waivers and where some AIT framework and other AWG software testing occur. A safety feature was added to the cluster to prevent damaging compute nodes if the cooling system should fail. Near monthly maintenance of the cluster system is necessary and included reorganization of server racks to accommodate short Infiniband cables, 130TB of data backed up to enable storage software update, and a new Lustre hardware setup for additional data storage source for cluster data processing.

The GRAFIIR team continues to expand capabilities and to work with AWG teams to meet their various needs. There is a continued effort to utilize McIDAS-V as a visualization tool when possible as well.



**Figure 8.2.1.** Simulated ABI band 15 (12.3 micrometer) data for June 4, 2005 at 20:20 UTC with “striping” (increased noise) added every 100<sup>th</sup> line. The striping is subtle and not detectable by the naked eye. Displayed in McIDAS-V.



**Figure 8.2.2.** The difference in simulated ABI band 15 (12.3 micrometer) data between unaltered data and striped data for June 4, 2005 at 20:20 UTC. This image is zoomed in over the state of Louisiana and the striping is evident here in the difference. Displayed in McIDAS-V.



### 8.3. AIT Technical Support

**CIMSS Task Leader: R.K. Garcia**

**CIMSS Support Scientists: G.D. Martin, E.N. Schiffer, W.C. Straka III**

**NOAA Collaborator: W. Wolf**

#### **NOAA Strategic Goals**

- Provide critical support for the NOAA mission

#### **CIMSS Research Themes**

- Satellite Meteorology Research and Applications

#### **Proposed Work**

The AIT-Midwest handles aspects of computer science cross-cutting AWG algorithm development teams at SSEC/CIMSS, and works in cooperation with the AIT-East in Washington, DC. This includes software development practices, software process management, documentation, testing and automation, infrastructure, general computing assistance, and systems design and optimization.

FY2012 proposed activities included:

- Profile and explore performance, accuracy, and reproducibility improvements in reference algorithm implementations;
- Review and update software and deliverables with CIMSS science staff;
- Retain and distribute test and ancillary datasets in support of AWG deliverables;
- Maintain, expand, and deploy verification and automation test tools in coordination with GRAFIIR and AIT-East;
- Provide guidance to science staff as needed to improve computer science aspects of algorithm reference software;
- Assist in implementation of collocation software and framework capabilities needed for Cal/Val of GOES-R data with other data sources including AQUA and TERRA;
- Continue refactoring and migration of science software toward framework- and platform-agnostic software interfaces in order to simplify existing code and provide new avenues for rapid algorithm development;
- Work with proxy team to prepare additional proxy data for Cal/Val;
- Implement GOES-R Fixed Grid format in reference/test science software;
- Add VIIRS processing capability to Geocat as a proxy for ABI;
- Work with proxy team to integrate proxy input into reference/test science software;
- Continued research/offline framework developments;
- Test integration work in cooperation with visualization group and AIT-East;
- SSEC/CIMSS infrastructure maintenance in support of AWG algorithm work and Cal/Val;
- Feedback and technical interchange with AIT-East and Harris/AER regarding computer science concerns in algorithm implementations and operational framework interfaces;
- This includes TIMs, weekly interchange meetings with AER/Harris/GSP, review of detailed design and ADD documents, and participation in the GS CDR;
- Review Product Definition and Users' Guide and make recommendations, in coordination with GRAFIIR; and
- Management and coordination of schedules, deliveries, software configuration items in cooperation with AWG and Harris/AER.





FY2012 milestones included:

- Version 5 delivery of Visibility algorithms to AIT-East, summer 2012;
- Baseline algorithms maintenance delivery;
- Harris / AIT TIMs and other interactions;
- Publish function-based algorithm / framework API documentation (deferred to FY2013);  
and
- New versions of GEOCAT, including support for provisional operational ABI GRB data format; new releases of ancillary data packages.

## **Summary of Accomplishments and Findings**

### ***Test Framework Development***

GEOCAT, the CIMSS algorithm development framework, and the NOAA AIT testing framework saw improvements. Additional algorithms were integrated, and the NOAA framework was tested at CIMSS to support GOES-R testing. Use of the reference science implementations in these frameworks has led to clarifications of theory and implementation for the operational code in development. It also led to refinements in the test datasets used for verification of contractor implementations of GOES-R algorithms. In addition, GEOCAT was expanded to process simulated data. This will help with determining how the algorithms will perform, as well as help developers make algorithm improvements prior to launch.

### ***Software Delivery and Development Support***

CIMSS AIT support for GOES-R prime contractor (Harris Corp., AER) interaction with NOAA and algorithm developers continued. This support included the 100% delivery of the Visibility algorithm to AIT-East for integration, and providing further patch-ports as inconsistencies were uncovered in reference algorithm software, test frameworks and theory documents. Re-delivery of test data, clarifications to responses, ATBD reviews and preparation for upcoming contractor software deliveries were also a part of integration support for GOES-R.

Support work also broadened to include experiment and demonstration applications of GOES-R algorithms to SNPP sensors as well as simulated ABI data. In the coming year a variety of activities are likely to be required along these lines, continuing the push toward equivalent software interfaces for software framework and satellite platform research algorithms.

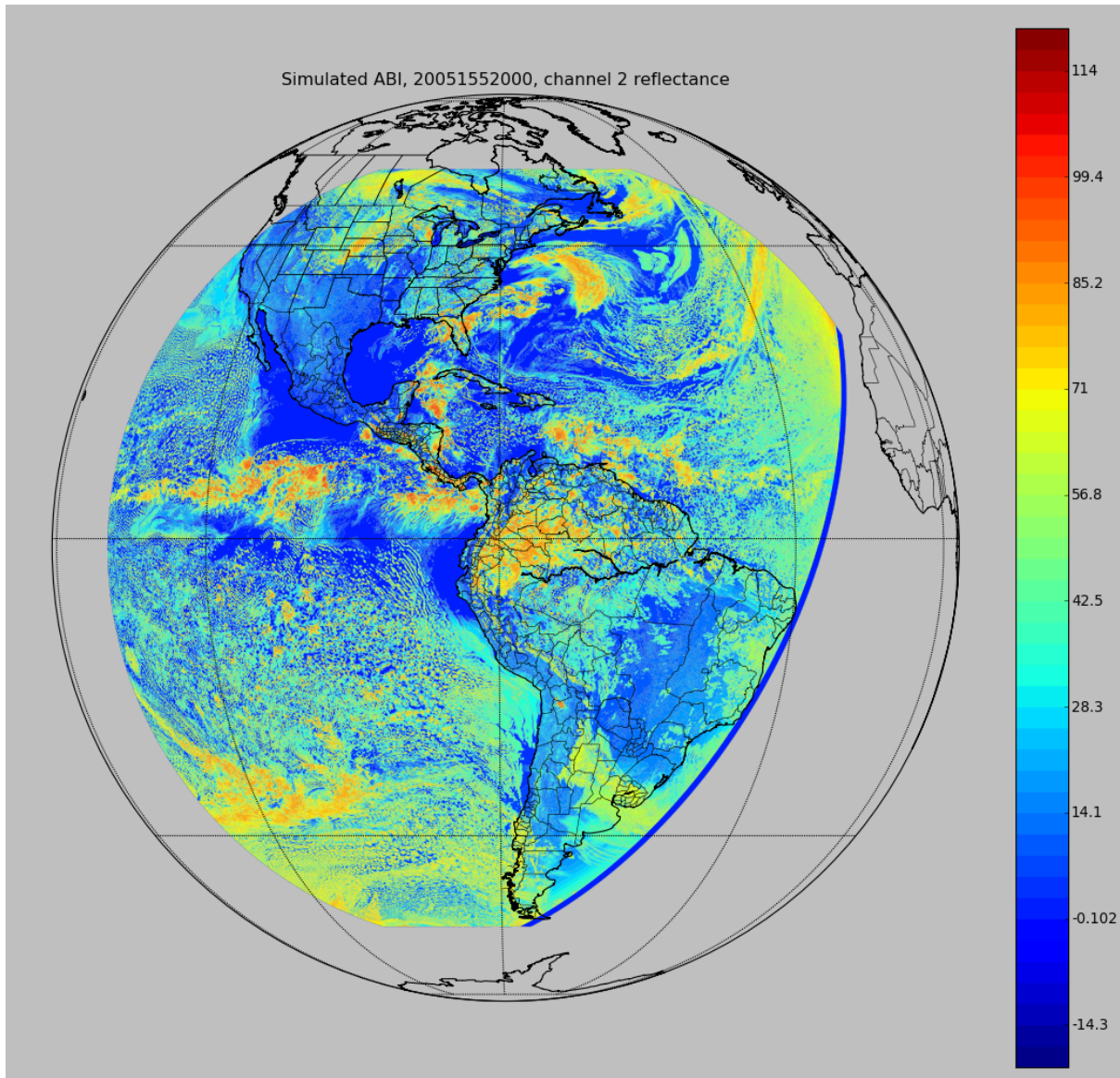


Figure 8.3.1. 0.6 $\mu$ m Simulated ABI reflectance image, as output from Geocat.

#### 8.4. GOES-R Collocation 2012

**CIMSS Task Leader: Robert Holz**

**CIMSS Support Scientists: Greg Quinn, Fred Nagle**

**NOAA Collaborator: W.Wolf**

**NOAA Strategic Goals**

- Provide critical support for the NOAA mission

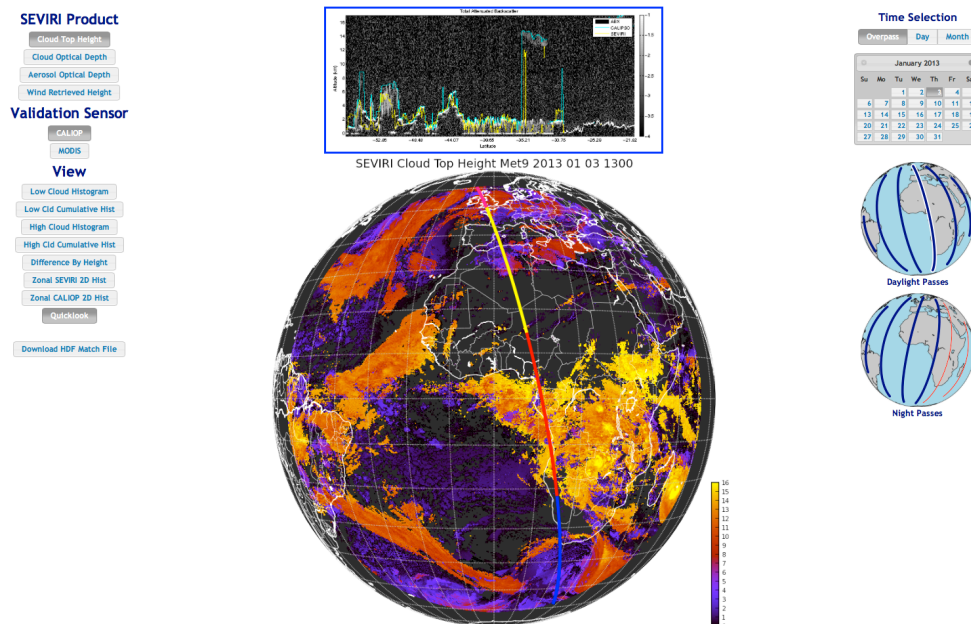
**CIMSS Research Themes**

- Satellite Meteorology Research and Applications



## Proposed Work

The main focus of this AWG task is to develop a collocation library based on over 30 years of collocation development at CIMSS and then using these tools, develop a validation system capable validating the GOES-R products with JPSS and NASA EOS observations. The past years focus has been on the development of a centralized GOES-R validation system that will provide near real-time GOES-R proxy (SEVIRI and GOES) validation results using both the NASA A-Train observations (CALIPSO, MODIS, CloudSat) and JPSS (CrIS, VIIRS, ATMS) observations. We have been working closely with the GOES-R products teams to customize the quick look and validation products. This effort leverages significantly from our JPSS cal/val activities with the goal of developing the foundation for a validation system for GOES-R post launch cal/val activities and facilitating better integration of JPSS and GOES-R. An example of the current version of the GOES-R validation site is presented in Figure 8.4.1. The site can be viewed at: <http://kepler.ssec.wisc.edu>.



**Figure 8.4.1.** A day view for the GOES-R wind validation is presented. This year's effort will be focused on continued development of the validation Web site leveraging the collocations software.

## Summary of Accomplishments and Findings

This is the fourth year of funding under the GOES-R program. Accomplishments to date include:

- Porting the AIRS/MODIS collocation software to C++,
- Developing a test system to validate the new C++ library,
- Inter-comparing the UW-Madison and NOAA versions of the AIRS/MODIS spatial weights,
- Testing the new collocation software by inter-calibrating AIRS and MODIS (both TERRA and AQUA),
- Developed GEO-LEO collocations methods prototyped in Fortran, and
- Validation Web interface and products for the GOES-R program.



## 8.5. ABI Cloud Products

**CIMSS Task Leader: William Straka III**

**CIMSS Support Scientists: Andi Walther, Pat Heck, Steve Wanzong**

**NOAA Collaborators: Andrew Heidinger, Michael Pavolonis**

### **NOAA Long Term Goals**

- Weather-Ready Nation

### **NOAA Strategic Goals**

- Serve society's needs for weather and water
- Support the nation's commerce with information for safe, efficient and environmentally sound transportation
- Provide critical support for the NOAA mission

### **CIMSS Research Themes**

- Satellite Meteorology Research and Applications
- Satellite Sensors and Techniques

### **Proposed Work**

National Environmental Satellite, Data, and Information Service, Center for Applications and Research (NESDIS/STAR) and the Cooperative Institute for Meteorological Studies (CIMSS) have been developing a suite of products that will offer advanced cloud detection and retrievals of cloud properties utilizing the GOES-R ABI instrument. The Cloud Algorithm Working Group (Cloud AWG) has developed five algorithms that generate fourteen independent cloud products. These include the clear sky mask, cloud type and phase, cloud top height, cloud top pressure, cloud top temperature, and both day and nighttime cloud microphysical properties.

### **Summary of Accomplishments and Findings**

The Cloud AWG has done a significant amount of work this year on the continued development of the Cloud algorithms, along with the validation of the various cloud algorithms. The Cloud AWG has been working with the GOES-R Ground Segment System Prime, Harris Corporation and AER, to help answer questions regarding the implementation of the GOES-R cloud products.

In September, the members of the Cloud AWG participated in the 2012 EUMETSAT Satellite Conference, where presentations were made regarding the cloud height and daytime optical property algorithms along with a summary of validation techniques.

Over the last year, the Cloud AWG has continued to improve upon each of the algorithms. While the ABI has not been launched at this point, the Cloud AWG continues using the SEVIRI instrument onboard the EUMETSAT Meteosat Second Generation geostationary orbiters as a proxy. In addition, several of the algorithms have been modified to work on other sensors, such as current GOES, MTSAT, MODIS and VIIRS. Also the Cloud Mask, Cloud Type/Phase, Cloud Height and Daytime Optical Properties algorithms were tested on simulated ABI data provided by the GOES-R proxy team.

For validation studies the Cloud AWG has been using other satellite sensors extensively, such as spaceborne lidars, (CALIPSO), passive microwave satellite sensors (AMSU, AMSR-E), ground microwave profilers (MWR at ARM site) and passive imagers (MODIS, AVHRR), as independent data sources. In addition, the Cloud AWG has made extensive use of the lidar on-board CALIPSO to tune the cloud mask for the least number of false detections. Using processed GOES Imager data as a proxy for ABI, we have developed tools to validate the cloud mask using skin temperature, total insolation and diffuse/total insolation measured at the surface. Figure 8.5.1



shows one such validation using the ratio of diffuse insolation to total insolation to determine cloudy/not cloudy at the Bondville, IL SURFRAD site, along with the GOES cloudiness fraction and the cloud mask's Probability of Correct Detection.

The Cloud AWG analyzed the cloud height and daytime cloud optical property algorithm against data taken from the University of Wisconsin's High Spectral Resolution Lidar (HSRL). Figure 8.5.2 shows the cloud optical depth differences for day and night. Daytime differences are plotted in green while nighttime differences are plotted in blue. There is very little difference between the ranges of optical depth differences for day and night. Results show that during daytime the ABI Cloud Height Algorithm (ACHA) optical depths are larger than those for HSRL, since the cloud height algorithm seems to be detecting thicker clouds during this time period. At night, though, there is more overlap between optical depth values for ACHA and HSRL.

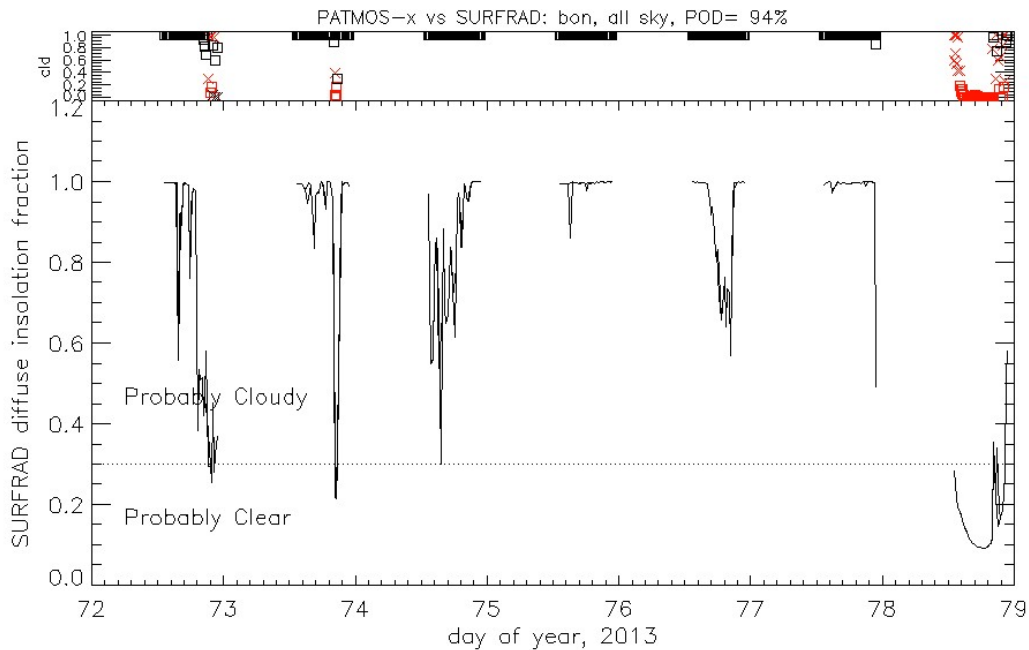
A large part of the AWG validation work involved the service of AWG cloud products from CIMSS to various field experiments. During 2013, the Deep Convective Clouds and Chemistry (DC3) Experiment took place in April, May and June in the central USA. AWG cloud products were served into the DC3 Data Catalog ([http://catalog.eol.ucar.edu/cgi-bin/dc3\\_2012/ops/index](http://catalog.eol.ucar.edu/cgi-bin/dc3_2012/ops/index)). Figure 8.5.3 shows an example image from the data catalog. These data were used in flight planning since one of the goals of the mission was to sample cirrus clouds. AWG cirrus heights were used in this planning process. HSRL data were used to validate the heights. Validation of other properties including cloud optical depth using the University of Colorado SSFR instrument is continuing.

Finally, the Cloud AWG team continues to work with the other Algorithm Working Groups, such as the Derived Motion Winds AWG, as well as other groups to continue to validate and improve the algorithms. This has included numerous validation studies of the cloud height algorithm from current sensors, which the Derived Motion Winds AWG has been using in a near-realtime sense. The DMW AWG is currently using the pixel level cloud phase, cloud type, and cloud top pressure product to assign the height of each DMW. Real-time processing includes Meteosat-10, GOES-13 and GOES-14. Figure 8.5.4 shows an example of the DMW height assignment compared to collocated CALIPSO data.

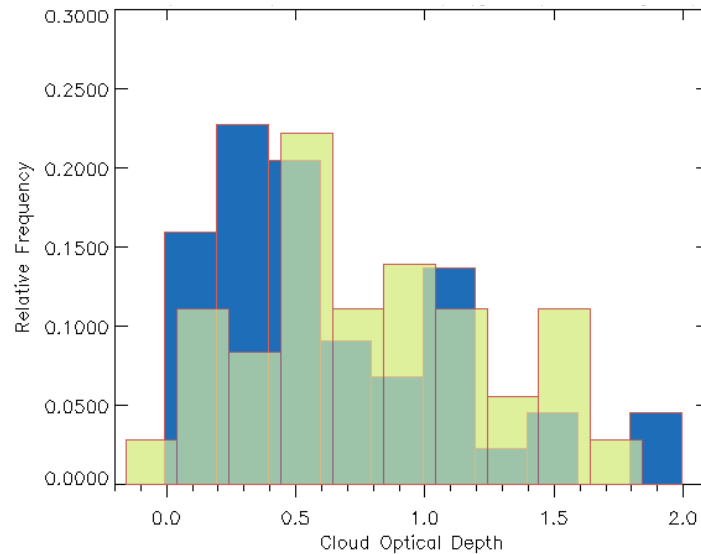
In the next year, the Cloud AWG will continue to be developing automated tools for the validation of the cloud algorithms.

### **Publications and Conference Reports**

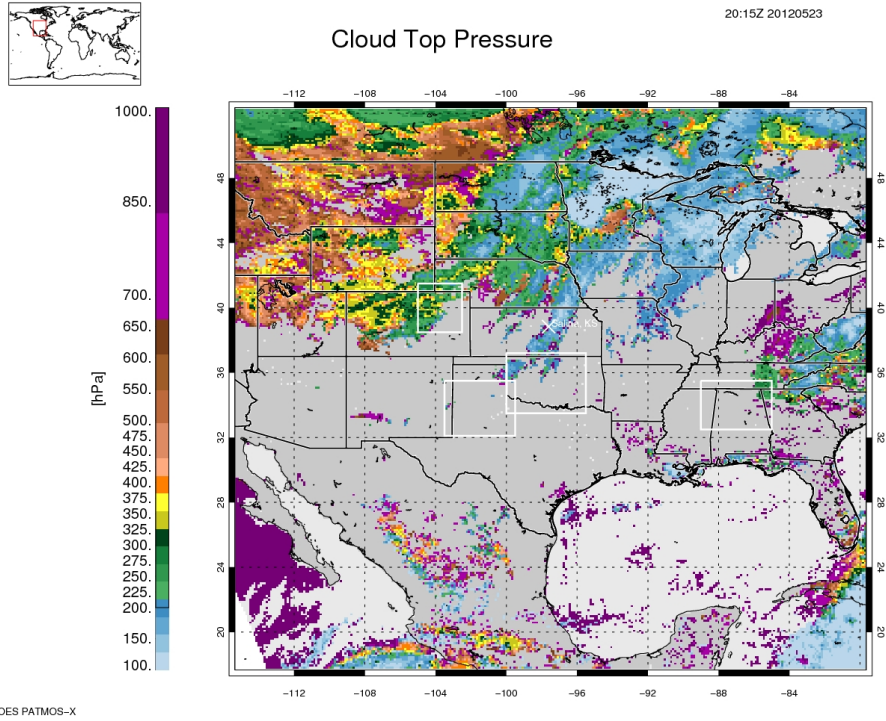
Bresky, Wayne C.; Daniels, Jaime M.; Bailey, Andrew A. and Wanzong, Steven T. New methods toward minimizing the slow speed bias associated with Atmospheric Motion Vectors. *Journal of Applied Meteorology and Climatology*, **51**, Issue 12, 2012, pp.2137-2151. Reprint #6924.



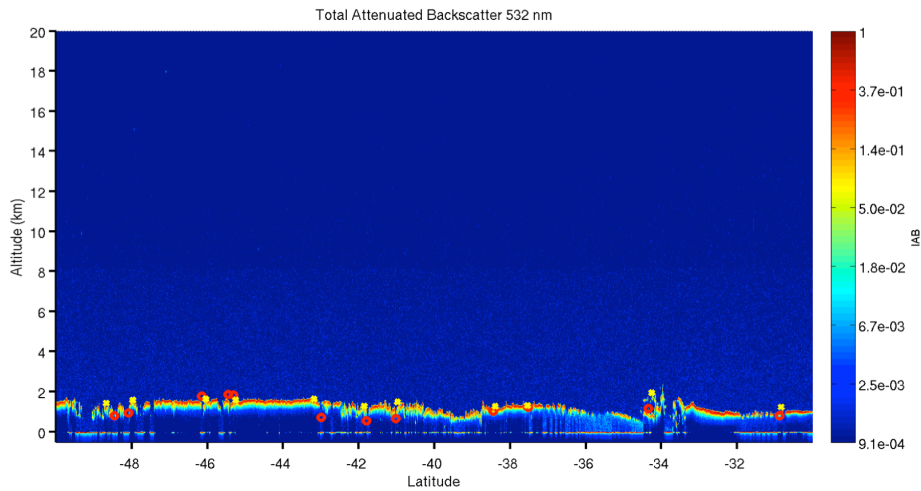
**Figure 8.5.1.** Cloud mask validation using the ratio between diffuse and total insolation measured at the Bondville, IL SURFRAD site (bottom axis). The probability of correct detection (POD) written above the figure is an evaluation of the cloudiness fraction (top axis) based on the cloud mask values within 10km of the site. The cloud mask is from GOES Imager data using the PATMOS-x cloud mask algorithm.



**Figure 8.5.2.** ACHA-HSRL Cloud Optical Depth Differences for June 2012 over Norman, OK. Daytime differences are in green while nighttime differences are plotted in blue.



**Figure 8.5.3.** Example image from the Deep Convective Clouds and Chemistry (DC3) Experiment Data Catalog ([http://catalog.eol.ucar.edu/cgi-bin/dc3\\_2012/ops/index](http://catalog.eol.ucar.edu/cgi-bin/dc3_2012/ops/index)).



**Figure 8.5.4.** CALIPSO total attenuated backscatter with collocated AMV-estimated cloud height plotted in red, and CALIPSO-estimated cloud tops in yellow. AMV height assignment shows good agreement with low-level water clouds.



## 8.6. Active Fire/Hot Spot Characterization (FIRE)

**CIMSS Task Leader: Chris Schmidt**

**CIMSS Support Scientists: Jay Hoffman, Elaine Prins (UW-Madison/CIMSS-Contractor), Jason Brunner**

**NOAA Collaborators: Yunyue Yu (NOAA/NESDIS/STAR), Ivan Csiszar (NOAA/NESDIS/STAR)**

### **NOAA Long Term Goals**

- Climate Adaptation and Mitigation
- Weather-Ready Nation

### **NOAA Strategic Goals**

- Understand climate variability and change to enhance society's ability to plan and respond
- Support the nation's commerce with information for safe, efficient and environmentally sound transportation
- Provide critical support for the NOAA mission

### **CIMSS Research Themes**

- Satellite Meteorology Research and Applications
- Satellite Sensors and Techniques

### **Proposed Work**

This effort has adapted the current GOES Wildfire Automated Biomass Burning Algorithm (WFABBA) to GOES-R ABI. CIMSS continued building on historical and current expertise at CIMSS in fire algorithm development for the GOES Imager and the global geostationary fire observation network by revising the WFABBA to address GOES-R ABI observational requirements. The updated WFABBA utilizes the improved fire monitoring capabilities on GOES-R and contains updates to the modules that identify and characterize sub-pixel fire activity. The tasks for the last year focused on providing continued support and guidance to the Harris/AER team that was adapting the fire algorithm delivered by CIMSS to the operational framework. Additionally, work on the deep-dive validation tool, as well as proxy data, was to be continued. CIMSS proposed to continue coordination with the NPOESS VIIRS fire team, UMD (Justice, Giglio, Schroeder), and STAR on fire code updates/modifications.

### **Summary of Accomplishments and Findings**

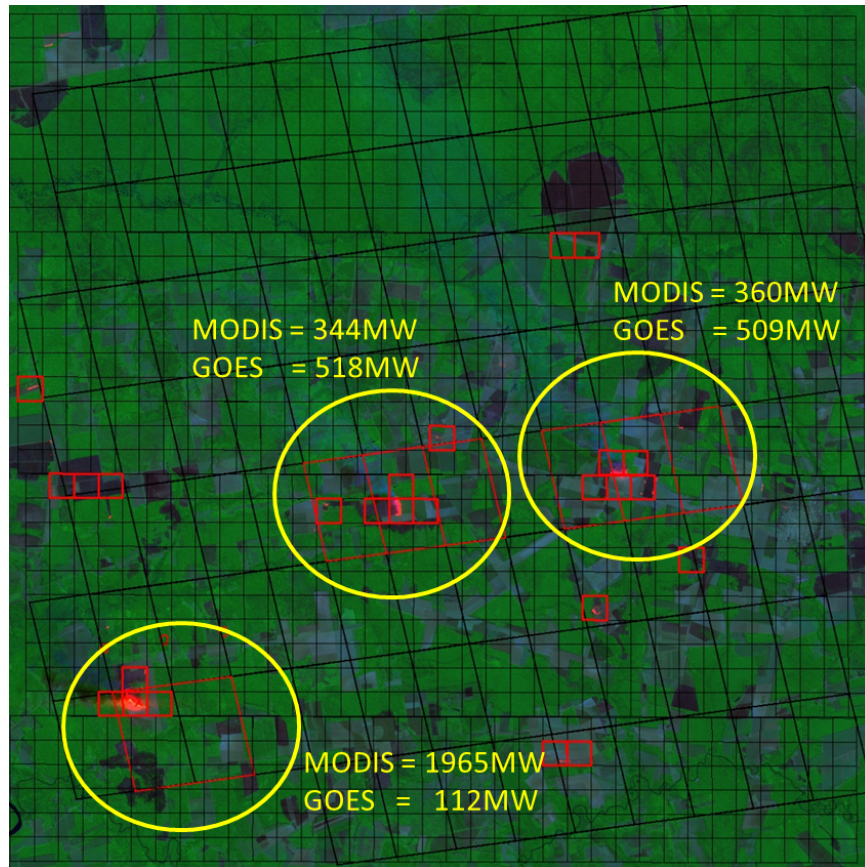
CIMSS responded to three sets of questions, and multiple individual inquires, about the algorithm as Harris/AER implemented it in the ABI processing framework. The algorithm was successfully implemented and full reproducibility of the proxy dataset was achieved in January 2013. Additionally, a much expanded proxy dataset had been provided by CIMSS consisting of data from model-derived proxy data provided by CIRA in previous years. Doing so addressed a lingering concern that the original request for proxy data for reproducibility testing was too limited. Due to the effort to achieve full reproducibility, any updates to the fire algorithm were on hold during this reporting period.

CIMSS continued to collaborate with STAR on the “deep-dive” validation tool for the ABI Fire algorithm. This tool takes high resolution data (e.g., 30m resolution Terra/ASTER and Landsat 7/ETM+ data) and uses that to validate the ABI fire algorithm in a variety of biomes. Due to lack of accurate ground truth data, application of high resolution satellite data remains the preferred and recommended method of validation in the biomass burning field. The method is labor-intensive and requires finding numerous ASTER scenes and the associated TERRA MODIS images that contain fires. The ASTER data are remapped to ABI using a method similar to that





used to remap MODIS data to ABI. The purpose of the tool is to simplify this labor-intensive form of validation as much as possible.



**Figure 8.6.1.** Intercomparison from the GOES-R ABI Fire Detection and Characterization Algorithm's deep-dive tool prototype. The base image is from ASTER, with red indicating hot pixel that are likely fires. The small boxes are outlines of MODIS pixels, and are outlined in red if the MODIS fire algorithm labeled them as fires. The skewed, overlapping squares are WFABBA detected GOES fire pixels, also outlines in red. A navigational correction was necessary to completely line up with dataset. The fire radiative power (FRP) output estimated by each satellite's fire algorithm is labeled, showing a contrast that correlates roughly to the location of the fire within the GOES pixel.

In collaboration with Dr. Wilfrid Schroeder of CICS, who has developed the deep-dive validation tool for STAR, a data comparison was performed between the current GOES and MODIS derived fire properties. This effort used those two datasets as proxy data for the deep-dive validation tool effort going forward. Figure 8.6.1, courtesy Dr. Schroeder, illustrates the comparison between GOES and MODIS fire pixel locations and the characterization properties (in this case, Fire Radiative Power, FRP), overlaid on top of an ASTER image from the same time. While the location agree reasonably well, it should be noted that a correction was necessary to address an apparent offset in the GOES navigation, an issue that has yet to be completely resolved. The characterizations do not match extremely well, however this was to some extent expected. The point spread function (PSF) of GOES is much broader than MODIS, and as can be seen by the pixel outlines, the fires occupy a very small portion of the pixel. Fires near the center of a GOES pixel are likely to appear too hot, and fires near the edge are likely to appear too cold. While that



is reflected in this particular case, due to the limited number of cases we cannot conclude that the PSF is the reason for the discrepancy.

## **8.7. GOES-R Legacy Atmospheric Profile, Total Precipitable Water (TPW) and Atmospheric Instability Indices**

**CIMSS Task Leader: Jun Li**

**CIMSS Support Scientists: Yong-Keun Lee, Zhenglong Li, Jim Nelson, Graeme Martin, Yue Li**

**NOAA Collaborator: Tim Schmit**

### **NOAA Long Term Goals**

- Climate Adaptation and Mitigation
- Weather-Ready Nation

### **NOAA Strategic Goals**

- Serve society's needs for weather and water
- Understand climate variability and change to enhance society's ability to plan and respond
- Provide critical support for the NOAA mission

### **CIMSS Research Themes**

- Satellite Meteorology Research and Applications

### **Proposed Work**

The main focus of this project is to develop the legacy atmospheric profile (LAP) algorithm for the next generation Geostationary Operational Environmental Satellite (GOES-R) Advanced Baseline Imager (ABI) (Schmit et al., 2005) product generation. The algorithm retrieves atmospheric temperature and moisture profiles and the derived products including total precipitable water (TPW), layer precipitable water (PW), lifted index (LI), convective available potential energy (CAPE), total totals index (TT), Showalter index (SI), and the K-index (KI) from the clear sky infrared (IR) radiances within a 5 by 5 ABI field-of-view (FOV) box area. This project requires CIMSS scientists to develop the GOES-R LAP algorithm to be able to process high temporal and spatial resolution ABI data efficiently. This project provides science codes to the GOES-R algorithm integration team (AIT) for algorithm integration and helps the system provider to implement the algorithm and codes into the GOES-R ground system. CIMSS scientists will also evaluate and validate the GOES-R LAP algorithm to assure that the GOES-R atmospheric temperature and moisture profiles, TPW, LI, CAPE, TT, SI and KI products meet the science requirements and applications.

### **Summary of Accomplishments and Findings**

At CIMSS, the GOES-R ABI LAP algorithm has been developed under the GOES-R Algorithm Working Group (AWG) program, and the algorithm has been delivered for pre-operation implementation. The main focus now is the validation of the GOES-R LAP product with SEVIRI, the current GOES Sounder and the Moderate Resolution Imaging Spectroradiometer (MODIS) IR radiance measurements as proxy for GOES-R ABI, because of the spectral similarity between ABI and those instruments. For validation purpose, the GOES-R LAP algorithm has been adapted to process SEVIRI, the current GOES Sounder and MODIS IR band radiance measurements. Validation tool is also designed and developed to help the evaluation of GOES-R LAP algorithm and the tool has deep dive capability to investigate the environment (temperature and dew-point temperature profiles) of any time input by the user. The major accomplishments on GOES-R LAP development and validation in 2012 are highlighted below:



### ***Validation of GOES-R LAP algorithm with MODIS***

CIMSS sounding team have worked with CIMSS MODIS team to transfer GOES-R LAP algorithm for real time generation of MODIS atmospheric products in direct broadcast with International MODIS and AIRS Processing Package (IMAPP) developed at CIMSS. The GOES-R LAP algorithm is also being adapted in the new version of NASA operational global MODIS atmospheric product (MOD07/MYD07) reprocessing and generation. The MODIS atmospheric profiles with GOES-R LAP algorithm are compared with the current operational MODIS atmospheric profile products using ECMWF analysis as reference. Both algorithms use the same 8 MODIS infrared spectral bands: bands 27 (6.535-6.895  $\mu\text{m}$ ), 28 (7.175-7.475  $\mu\text{m}$ ), 29 (8.400-8.700  $\mu\text{m}$ ), 31 (10.780-11.280  $\mu\text{m}$ ), 32 (11.770-12.270  $\mu\text{m}$ ), 33 (13.185-13.485  $\mu\text{m}$ ), 34 (13.485-13.785  $\mu\text{m}$ ), 35 (13.785-14.085  $\mu\text{m}$ ), and derive the atmospheric profiles on 5 by 5 FOV basis and with 1 km MODIS cloud mask for cloud detection. The GOES-R LAP algorithm is based on 1DVAR methodology while the current operational MODIS algorithm is based on the regression technique. Validation shows that GOES-R LAP results from MODIS are similar with GFS (forecast) in temperature, but closer to ECMWF analysis data than GFS in relative humidity between 300-700 hPa, which is consistent with that from SEVIRI and GOES Sounder radiance measurements.

### ***Validation of GOES-R LAP algorithm with GOES Sounder***

The GOES-R ABI LAP retrieval algorithm is applied to process the current GOES-13 Sounder radiance measurements for validation purpose as well as for potential transition of the GOES-R algorithm for operational GOES Sounder data processing. For the validation of the GOES-R LAP retrieval algorithm, five reference (“truth”) measurements such as radiosonde observation (RAOB) and microwave radiometer (MWR) measured total precipitable water (TPW) at the Atmospheric Radiation Measurement (ARM) Cloud and Radiation Testbed (CART) site, conventional RAOB, Global Positioning System-Integrated Precipitable Water (GPS-IPW) NOAA network TPW measurements, and TPW from the Advanced Microwave Scanning Radiometer for EOS (AMSR-E), are collected over east Continental United States (CONUS) from February 11, 2011 to August 30, 2012. AMSR-E TPW is collected from February 11, 2011 to October 4, 2011 due to the end of AMSR-E operation. With the GOES-R LAP algorithm, the GOES-13 Sounder provides better water vapor profiles over GFS forecast fields at the levels between 300 hPa and 700 hPa. Root mean square error (RMSE) and standard deviation (STD) of the GOES-13 Sounder TPW with the GOES-R LAP algorithm are consistently reduced from those of the GFS forecast no matter which measurements are used as the truth. The results indicate that the GOES-R LAP algorithm provides substantial improvement from the GFS forecast fields. Based on these results, the GOES-R LAP algorithm is well prepared for providing quality continuation to the current GOES Sounder, and the algorithm can potentially be transferred to process the current GOES Sounder measurements for operational product generation.



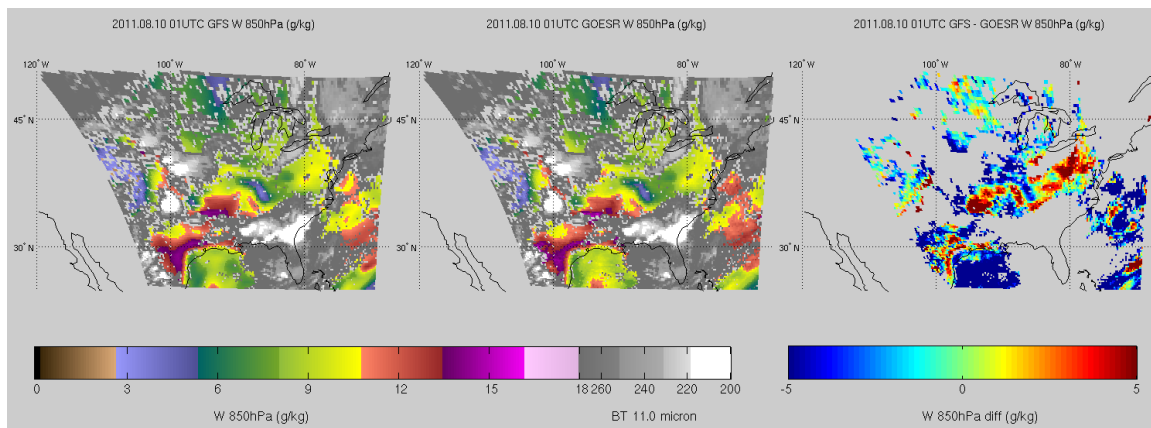
**Table 8.7.1.** RMSE and STD from GOES-13 Sounder with GOES-R LAP algorithm compared with various references.

References	GOES-13 LAP				GFS forecast				Samples
	RMSE (mm)	BIAS (mm)	STD (mm)	Corr	RMSE (mm)	BIAS (mm)	STD (mm)	Corr	
MWR	2.19	0.84	2.03	0.99	2.57	0.88	2.42	0.98	6338
ARM RAOB	2.93	1.52	2.50	0.98	3.15	1.56	2.73	0.98	1079
Conventional RAOB	3.12	0.28	3.10	0.97	3.29	0.29	3.28	0.97	25529
GPS	2.29	0.38	2.25	0.98	2.45	0.20	2.44	0.98	1010609
AMSR-E	2.36	-0.83	2.21	0.98	2.89	-1.52	2.45	0.98	3847196

Table 8.7.1 above shows the statistics of TPWs from the GOES-13 LAP algorithm results and the GFS forecast compared to the references except AMSR-E during the period between Feb. 11 2011 and Aug. 30, 2012. For AMSR-E comparison the period is between Feb. 11, 2011 and Oct. 4, 2011 due to the AMSR-E operation issue.

**GOES-R LAP Validation Tool New Developed**

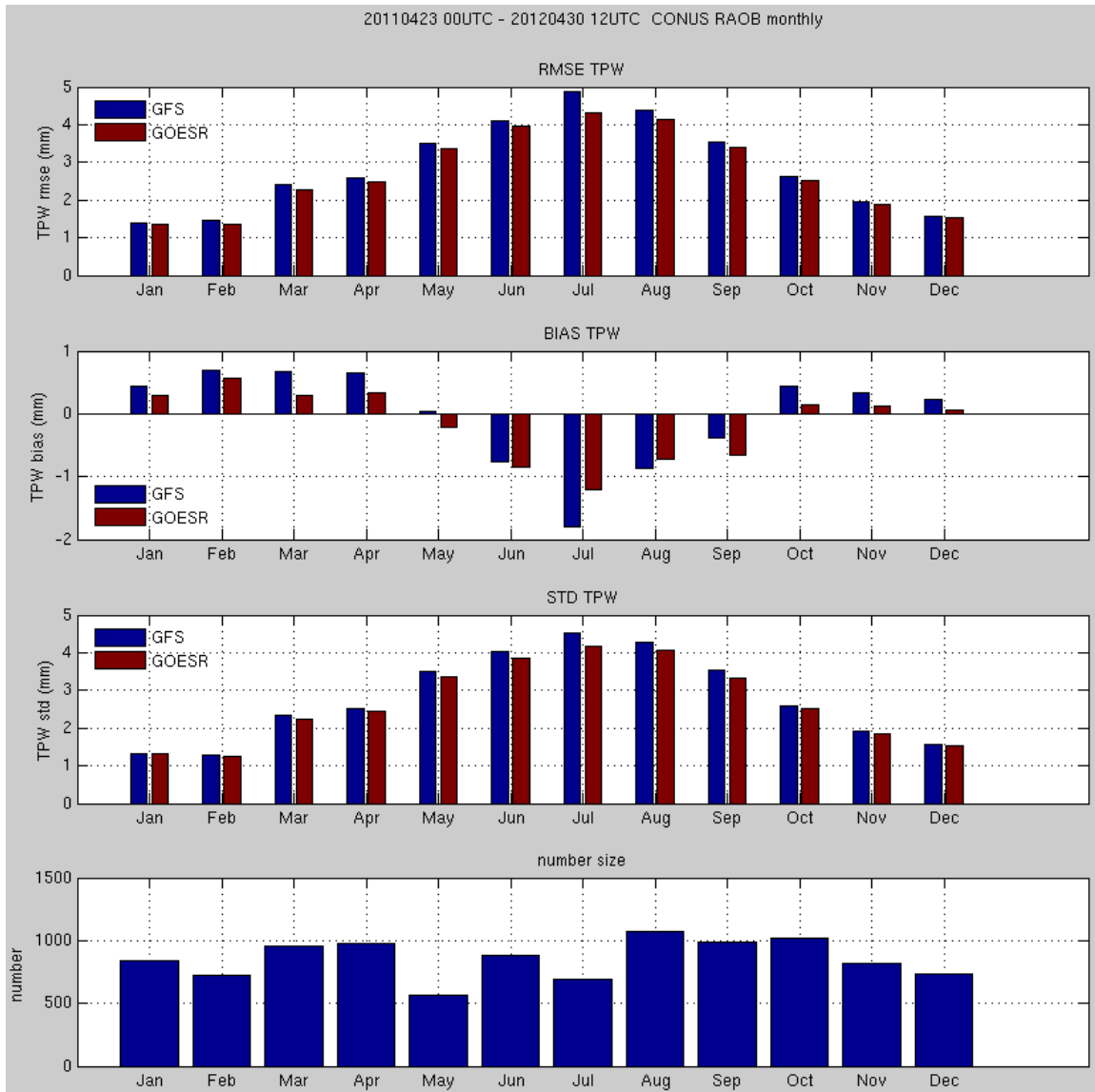
The GOES-R LAP Validation Tool has many functions including the capability to show horizontal imagery of brightness temperature (BT) at selected bands (band 1 ~ band 18), temperature and moisture at selected pressure levels (100, 200, 300, 400, 500, 700, 850 and 1000 hPa for temperature (K) and 300, 400, 500, 700, 850, and 1000 hPa for water vapor (g/kg)), and TPW (mm), and atmospheric stability indices (CAPE, Lifted Index, K-Index, Total Totals, Showalter Index) for clear sky over east CONUS for the period between August 1 and 10, 2011. BTs at selected bands are from GOES-13 measurements and other variables are from GFS and GOES-R ABI LAP retrievals. The BT imagery and the comparison of GOES-R ABI LAP with GFS are useful in monitoring the retrieval’s overall quality. Figure 8.7.1 shows the horizontal imagery comparison between GFS (left panel) and GOES-R LAP (middle panel) for 850 hPa water vapor with cloudy regions filled with GOES-13 11 μm BTs at 01 UTC on August 10, 2011.



**Figure 8.7.1.** Horizontal imagery comparison between GFS (left panel) and GOES-R LAP (middle panel) for 850 hPa water vapor with cloudy regions filled with GOES-13 11 μm BTs at 01 UTC on August 10, 2011.



The Validation Tool also has the capability to show monthly statistical information for 57 conventional RAOB sites over one-year period between April 23, 2011 and April 30, 2012 for variables including TPW and atmospheric stability indices (CAPE, Lifted Index, K-Index, Total Totals, Showalter Index). Figure 8.7.2 shows monthly statistics of GFS and GOES-R ABI LAP TPW. Bias, standard deviation, root mean square error, and the data size are provided.



**Figure 8.7.2.** GFS and GOES-R LAP TPW from GOES-13 Sounder monthly statistical comparison with RAOB for the period from April 23, 2011 00UTC to April 30, 2012 00UTC for all 57 conventional locations over CONUS area.

### Publications and Conference Reports

Li, Z., J. Li, Y. Li, T. Schmit, L. Zhou and M. D. Goldberg, 2013: Determining Infrared Land Surface Emissivity Diurnal Variation from Satellites, 93rd AMS Annual Meeting, 9 – 13 January 2013, Austin, TX.



Lee, Yong-Keun, Zhenglong Li, Jun Li, and Timothy J. Schmit, 2013: Evaluation of the GOES-R ABI LAP retrieval algorithm using the current GOES sounder, *Journal of Applied Meteorology and Climate* (submitted).

Li, Z., J. Li, Y. Li, Y. Zhang, T. J. Schmit, L. Zhou, M. Goldberg, and W. Paul Menzel, 2012: Determining Diurnal Variations of Land Surface Emissivity from Geostationary Satellites, *Journal of Geophysical Research – Atmospheres*, **117**, D23302, doi:10.1029/2012JD018279.

## References

Schmit, T. J., M. M. Gunshor, W. Paul Menzel, J. Gurka, J. Li, and S. Bachmeier, 2005: Introducing the next-generation advanced baseline imager (ABI) on GOES-R. *Bull. Amer. Meteorol. Soc.*, **86**, 1079 - 1096.

Schmit, T. J., J. Li, J. J. Gurka, M. D. Goldberg, K. Schrab, Jinlong Li, and W. Feltz, 2008: The GOES-R Advanced Baseline Imager and the continuation of current GOES sounder products, *J. of Appl. Meteorol. and Climatology*, **47**, 2696 – 2711.

Seemann, S. W., J. Li, W. Paul Menzel, and L. E. Gumley, 2003: Operational retrieval of atmospheric temperature, moisture, and ozone from MODIS infrared radiances, *J. Appl. Meteorol.*, **42**, 1072 - 1091.

Lee, Yong-Keun, Zhenglong Li, Jun Li, and Timothy J. Schmit, 2013: Evaluation of the GOES-R ABI LAP retrieval algorithm using the current GOES sounder, *Journal of Applied Meteorology and Climate* (to be submitted).

## 8.8. GOES-R AWG ABI Winds

**CIMSS Task Leaders: Chris Velden and Steve Wanzong**

**NOAA Collaborator: Jaime Daniels (STAR)**

**NOAA Long Term Goals**

- Weather-Ready Nation

**NOAA Strategic Goals**

- Serve society's needs for weather and water
- Provide critical support for the NOAA mission

**CIMSS Research Themes**

- Satellite Meteorology Research and Applications
- Satellite Sensors and Techniques

## Proposed Work

In preparation for the launch of GOES-R, the NOAA GOES-R Algorithm Working Group (AWG) winds team is actively developing atmospheric motion vector (AMV) derivation algorithms and using them in demonstration studies. The AMV algorithm development has reached a mature stage and the project is now in a validation mode. The software is being tested in a near real-time demonstration mode using Meteosat-9 SEVIRI data as ABI proxy imagery, with the resultant AMVs validated against “truth” datasets. Hourly AMVs from Meteosat-9 will be produced in near real-time and validated against the GFS analysis wind fields. Visible AMVs from band 1 (0.6  $\mu\text{m}$ ) are produced hourly from 08 UTC until 19 UTC. Short wave IR (SWIR) AMVs from band 4 (3.90  $\mu\text{m}$ ) are run from 00 UTC until 07 UTC and then again from 20 UTC until 23 UTC. Band 1 and band 4 produce complimentary AMVs (low-level only), so our



processing strategy does not allow for product overlap. Cloudy water vapor AMVs (upper-level only) from band 8 (6.2  $\mu\text{m}$ ) and long wave IR (LWIR) AMVs from band 14 (11.2  $\mu\text{m}$ ) are produced every hour. Match files comparing AMVs to the GFS analysis winds are produced 4 times daily at 00, 06, 12, and 18 UTC. We also propose to look at AMV height assignment in more depth with Cloud-Aerosol Lidar and Infrared Pathfinder Satellite Observations/Cloud-Aerosol Lidar with Orthogonal Polarization (CALIPSO/CALIOP) observations.

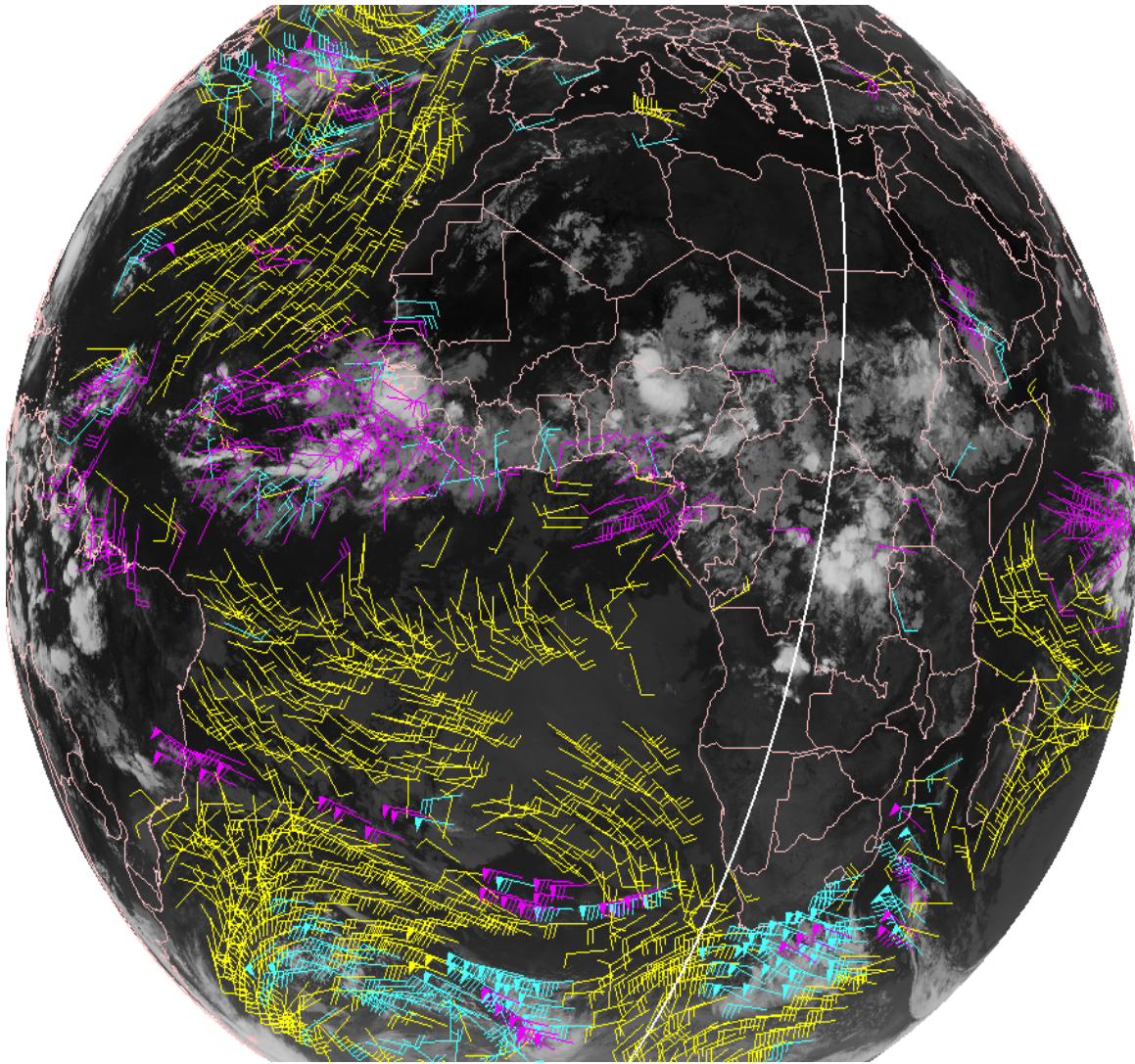
### Summary of Accomplishments and Findings

During this reporting period, we compiled AMV-GFS analysis match statistics, and are used to measure the performance of the AMV product over oceanic regions. The analysis winds must match the time of the AMV, and are spatially (horizontally and vertically) interpolated to the AMV location. An advantage of this approach is that an AMV/GFS analysis wind collocation match can be generated for nearly all AMVs produced. The temporal time check is the only restriction needed. There is no need to check vertical limits, as the full GFS profile is always available. The maximum vertical spacing between pressure levels in the GFS analysis is 50 hPa. Thus the AMV will be within 50 hPa from a GFS pressure level, which implicitly matches the RAOB vertical match requirement. Horizontal limits are also ignored. Generally, the AMV is within 10 km or less of a model grid point, which is much less than the RAOB requirement of approximately 150 km. In all cases, accuracy, precision and speed bias requirements are being met.

The other activity involves the analysis of AMV height assignments using the CALIPSO observations as a benchmark comparison dataset. AMV-CALIPSO collocations provide a novel way to look into the validity of the AMV height assignment within the GOES-R nested-tracking software. In the example to follow, we look at AMVs from a typical proxy dataset using Meteosat-9 Seviri from 15 September 2011 at 00 UTC. Figure 8.8.1 is a plot of IRW channel AMVs ( $QI > 60$ ). Upper-level AMVs are plotted in pink (100-400 hPa), mid-level in blue (400-700 hPa) and low-level in yellow (700-1000 hPa). The white line represents the CALIPSO transect location nearest the time of the middle image of the Seviri loop.

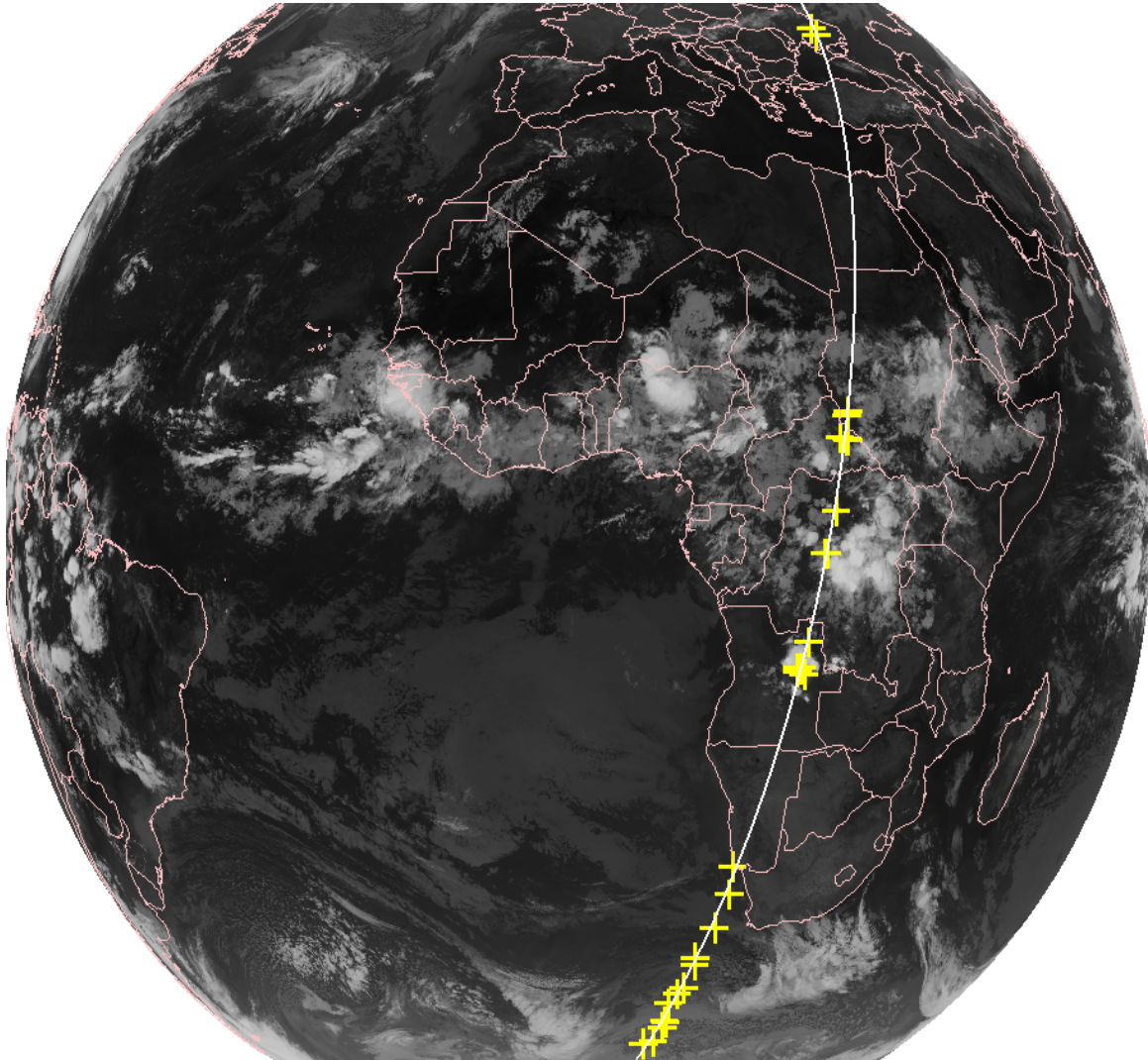
To ensure high quality matches, the AMVs must have an internal quality indicator (QI) of 60 or greater, with a maximum of 100. The AMVs must be spatially located within 50 km of the CALIPSO transect location. Lastly, the AMV middle image time is required to be within 30 minutes or less from the CALIPSO profile time. Only CALIPSO profiles with single layer clouds are considered in the match software. Additionally, we require the CALIPSO cloud to have an optical depth of greater than 0.5. This filters out most CALIPSO data that the passive Seviri instrument would be unable to sense. The AMV-CALIPSO comparisons are limited to assessing differences in height assignment only. Figure 8.8.2 shows the AMV CALIPSO match locations as yellow “plus signs”. In this example, more than 10,000 IRW AMVs are present in this dataset. But when we apply the collocation filtering described above, we find 30 successful matches between the AMVs and the CALIPSO profiles.

Figure 8.8.3 shows an altitude-time x-section image of the total attenuated CALIPSO (532 nm) backscatter (/km/sr) plotted along with the collocated AMV locations in red, and the CALIPSO cloud top height product in yellow. Only the AMVs in southern Atlantic Ocean off the coast of Africa in the figure above are considered in this image. Good agreement in low-level water cloud tops is observed between the AMV heights compared to the CALIPSO cloud top height product.

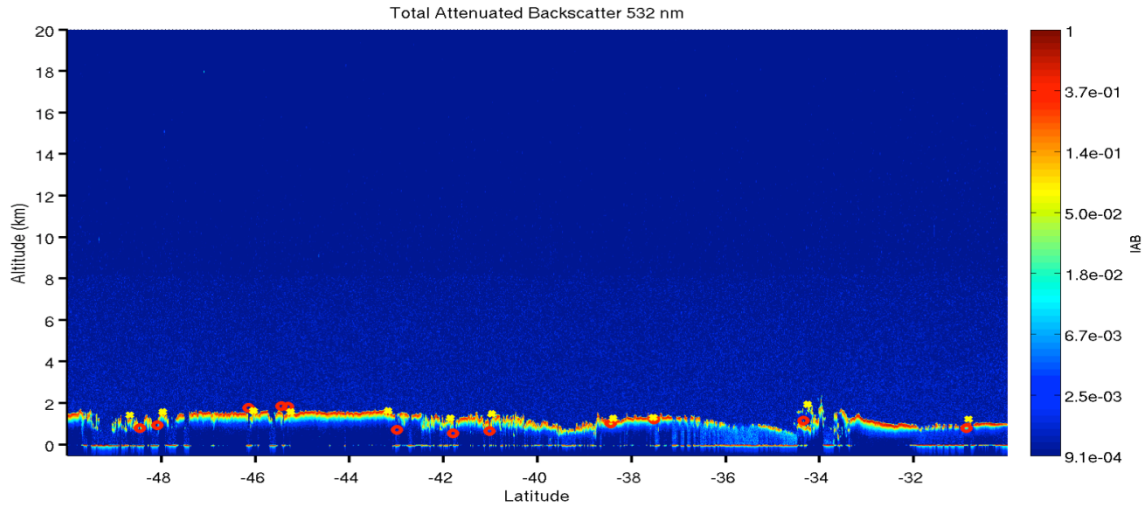


**Figure 8.8.1.** IRW AMVs from Meteosat-9 plotted with the CALIPSO transect locations in white.





**Figure 8.8.2.** AMV and CALIPSO match locations (yellow pluses) for 15 Sept. 2011, at 00 UTC.



**Figure 8.8.3.** CALIPSO total attenuated backscatter with collocated AMV-estimated cloud height assignments plotted in red, and CALIPSO-estimated cloud tops in yellow.

### Publications and Conference Reports

Daniels, Jamie, Bresky, Wayne, Wanzong, Steve and Velden, Christopher: Atmospheric Motion Vectors derived via a new nested tracking algorithm developed for the GOES-R Advanced Baseline Imager (ABI). Annual Symposium on Future Operational Environmental Satellite Systems, 9th, Austin, TX, 6-10 January 2013. American Meteorological Society, Boston, MA.

Bormann, Niels, Hernandez-Carrascal, A, Borde, R. Lutz, H-J. Otkin, J. A. and Wanzong, S.: Atmospheric Motion Vectors from model simulations. Part I: Methods and characterization as single-level estimates of wind. *Journal Applied Meteorology and Climatology*, 2012. Submitted 7 December 2012.

Bresky, Wayne C., Daniels, J. M., Bailey, A. A. and Wanzong, S. T.: New methods toward minimizing the slow speed bias associated with Atmospheric Motion Vectors. *Journal of Applied Meteorology and Climatology*, Volume 51, Issue 12, 2012, pp. 2137-2151.

Hernandez-Carrascal, A. Bormann, N., Borde, R., Lutz, H. -J., Otkin, J. and Wanzong, S.: Atmospheric Motion Vectors from model simulations. Part 1: Methods and characterization as single-level estimates of wind. Technical Memorandum, European Centre for Medium-Range Weather Forecasts, October 2012.

Wanzong, Steve, Bresky, Wayne C., Velden, Christopher S., Daniels, Jaime M. and Bailey, Andrew A.: GOES-R readiness: Atmospheric Motion Vector (AMV) validation activities. International Winds Workshop, 11th, Auckland, New Zealand, 20-24 February 2012. EUMETSAT, Darmstadt, Germany, 2012.

Daniels, Jamie, Bresky, Wayne, Wanzong, Steve, Bailey, Andrew and Velden, Christopher.: Atmospheric Motion Vectors derived via a new nested tracking algorithm developed for the GOES-R Advanced Baseline Imager (ABI). International Winds Workshop, 11th, Auckland, New Zealand, 20-24 February 2012. EUMETSAT, Darmstadt, Germany, 2012.



## 8.9. GOES-R AWG Hurricane Intensity Estimation (HIE) Algorithm

**CIMSS Task Leaders: Chris Velden and Tim Olander**

**NOAA Collaborator: Jaime Daniels (STAR)**

**NOAA Long Term Goals**

- Weather-Ready Nation

**NOAA Strategic Goals**

- Serve society's needs for weather and water
- Provide critical support for the NOAA mission

**CIMSS Research Themes**

- Satellite Meteorology Research and Applications
- Satellite Sensors and Techniques

### Proposed Work

The CIMSS Advanced Dvorak Technique (ADT, Velden and Olander 2007) was selected to be the operational Hurricane Intensity Estimation (HIE) algorithm to operate within the GOES-R framework. The HIE will provide tropical cyclone (TC) intensity estimates using the GOES-R Advanced Baseline Imager (ABI) infrared imagery. The ADT was selected due to its longstanding use at several operational TC centers worldwide, and because of its proven record for accuracy and reliability in providing TC intensity estimates, especially where aircraft reconnaissance is not available.

### Summary of Accomplishments and Findings

During this reporting period, CIMSS scientists continued to support the development of the HIE algorithm into operational code by Harris/AER programmers within their system through documentation review and answering questions raised by code developers and document writers. A vast majority of the work focused on addressing HIE algorithm code questions and issues found by AER/Harris programmers during their conversion process. Questions ranged from those related to simple clarification of what specific variables were used for and what various sections of code performed in the HIE intensity derivation process to identification of potential and existing logic flaws. All issues were addressed and responded to sufficiently and in a timely manner. In addition, clarification of the related sections of the HIE Algorithm Description Document (ADD), based upon the HIE Advanced Theoretical Basis Document delivered previously by CIMSS scientists, were provided to AER/Harris, as necessary. The ATBD was also updated to reflect the ADD modifications and continues to be updated as new questions and clarifications are requested by and provided to AER/Harris programmers.

Review of the HIE output netCDF files was performed to assess the accuracy of the variables stored in these files. Specific focus was given to the derivation of the wind speed output values and making sure the correct default/missing variables were stored in the file at the proper time.

### Publications and Conference Reports

Olander, T., and C. Velden, 2012: The current status of the UW-CIMSS Advanced Dvorak Technique (ADT), 30th Conf. on Hurricanes and Tropical Meteorology, Ponte Vedra Beach, FL, April 15-20.

### References

Olander, T. and C. Velden, 2007: The Advanced Dvorak Technique: Continued Development of an Objective Scheme to Estimate Tropical Cyclone Intensity Using Geostationary Infrared Satellite Imagery. *Wea. & Forecasting*, **22**, 287-298.



## 8.10. Volcanic Ash

**CIMSS Task Leader: Justin Sieglaff**

**NOAA Collaborator: Michael Pavolonis**

### **NOAA Long Term Goals**

- Weather-Ready Nation

### **NOAA Strategic Goals**

- Support the nation's commerce with information for safe, efficient and environmentally sound transportation

### **CIMSS Research Themes**

- Satellite Meteorology Research and Applications
- Satellite Sensors and Techniques
- Environmental Models and Data Assimilation

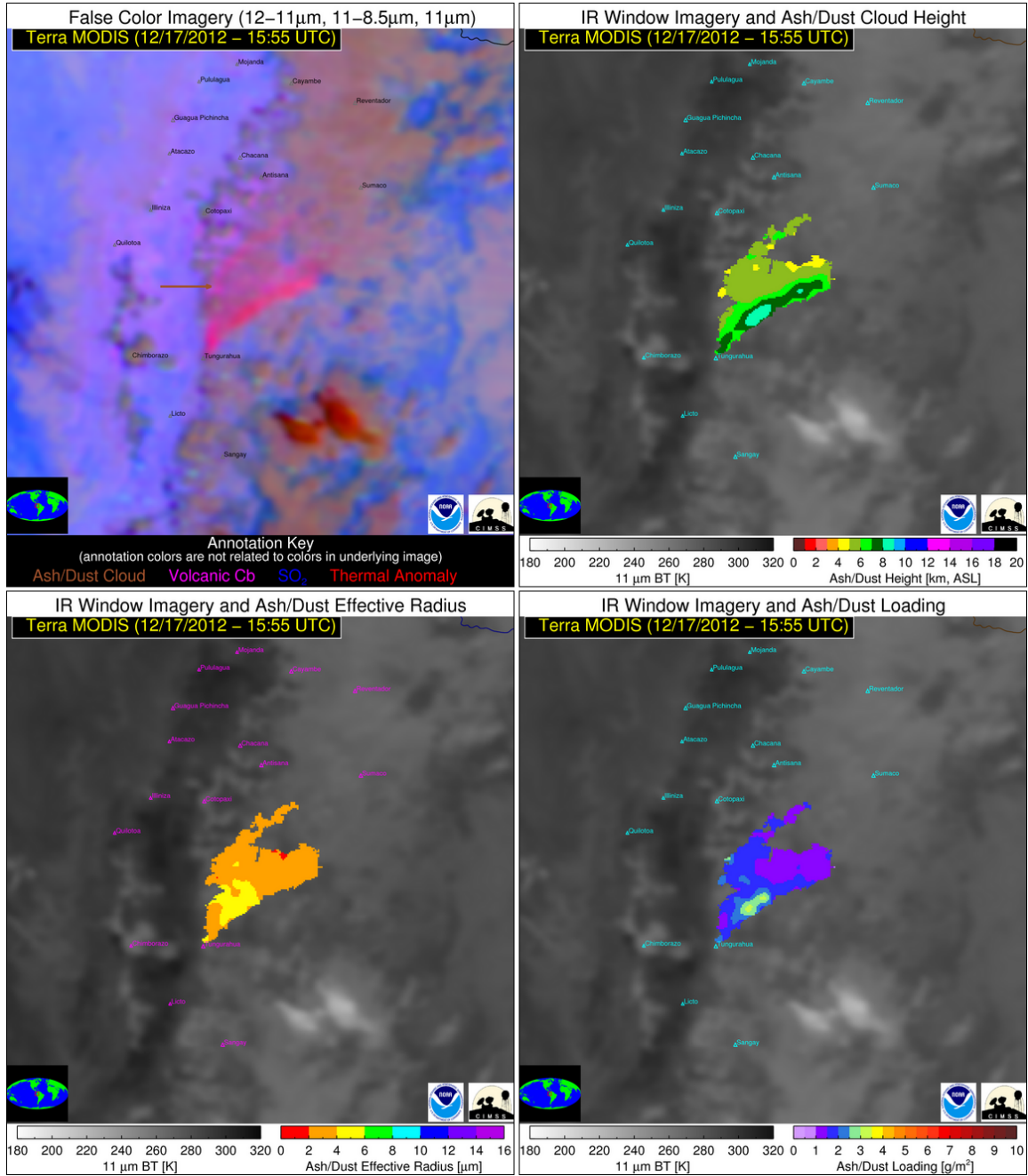
### **Proposed Work**

We have adopted an infrared-based approach for detecting the presence of ash. This information is supplied to an ash cloud height and mass loading retrieval scheme. We propose to continue to conduct the cal/val and development work required to assure that we achieve the F&PS specifications for the volcanic ash products. We will perform extensive validation using spaceborne lidar (e.g., CALIPSO) observations of volcanic ash and dust clouds. Any problems discovered in the cal/val process will be addressed. Much of the work will also be aimed at providing GOES-R Ground System (GS) contract support. This work will insure the readiness of the volcanic ash algorithm for operational implementation upon the deployment of GOES-R.

### **Summary of Accomplishments and Findings**

Like the previous year, to ensure readiness of the volcanic ash algorithm we have participated in Technical Interchange Meetings and AERs with the ground segment to resolve questions related to the implementation of the GOES-R Volcanic ash algorithm.

We continue to test and validate the GOES-R Volcanic ash algorithm as volcanic events occur. Figure 8.10.1 is an example of the GOES-R volcanic retrievals for an eruption of Tungurahua volcano in Ecuador from December 2012. The GOES-R volcanic retrievals were performed using MODIS data, which serves as a good proxy for ABI since MODIS has the three spectral IR channels (11, 12, and 13.3  $\mu\text{m}$ ) needed to perform the GOES-R volcanic retrievals. This case is particularly interesting because products issued by the Washington DC Volcanic Ash Advisory Center (VAAC) for this event noted the numerical weather prediction model winds were not matching up with the ash cloud movement noted in satellite imagery (<http://www.ssd.noaa.gov/VAAC/ARCH12/TUNG/2012L171828.html>). The disagreement between model winds and observations made volcanic cloud height assessment difficult and in this case, the GOES-R Volcanic retrievals could have been an essential piece of information in assigning the flight level to which volcanic ash resided.



**Figure 8.10.1.** An example of GOES-R Volcanic retrievals for an eruption of Tungurahua volcano in Ecuador using MODIS from 1555 UTC 17 December 2012. Top left is a false color image, top right is ash height [km], bottom left is effective radius [ $\mu\text{m}$ ], and bottom right is mass loading [ $\text{g m}^{-2}$ ].

### Publications and Conference Reports

Pavolonis, M. J., 2010: Advances in extracting cloud composition information from spaceborne infrared radiances: A robust alternative to brightness temperatures. Part I: Theory. *J. Applied Meteorology and Climatology*, **49**, 1992-2012.



## References

Pavolonis, M. J., 2010: Advances in extracting cloud composition information from spaceborne infrared radiances: A robust alternative to brightness temperatures. Part I: Theory. *J. Applied Meteorology and Climatology*, **49**, 1992-2012.

Pavolonis, M. J., 2011: Advances in extracting cloud composition information from spaceborne infrared radiances: A robust alternative to brightness temperatures. Part II: Proof of concept. To be submitted to: *J. Applied Meteorology and Climatology*.

## 8.11. CIMSS GOES-R Algorithm Working Group (AWG): Visibility

**CIMSS Task Leader: Wayne Feltz**

**CIMSS Support Scientists: Allen Lenzen, Jason Brunner**

**NOAA Collaborator: R. Bradley Pierce**

**NOAA Long Term Goals**

- Weather-Ready Nation

**NOAA Strategic Goals**

- Serve society's needs for weather and water
- Support the nation's commerce with information for safe, efficient and environmentally sound transportation

**CIMSS Research Themes**

- Satellite Meteorology Research and Applications

### Proposed Work

The Advanced Baseline Imager (ABI) visibility product is produced using a number of other ABI products including the low-cloud/fog detection, cloud optical thickness, and aerosol optical depth. To determine the range of visibilities associated with low-cloud/fog the visibility product uses the ABI cloud optical thickness (COT). To determine the range of visibilities associated with haze, dust, and smoke the visibility product uses the ABI aerosol optical depth (AOD) retrieval. Under low-cloud/fog, haze, dust, and smoke conditions the visibility algorithm must be able to relate COT and AOD (at a particular wavelength) to horizontal visibility within the planetary boundary layer. Thresholds for Poor, Low, Moderate, and Clear visibilities have been developed based on statistical regression of proxy satellite AOD and COT measurements and planetary boundary layer thermodynamic properties against Automated Surface Observing System (ASOS) extinction measurements. Conversion from AOD or COT to extinction requires knowledge of the depth of the aerosol or fog/low-cloud layer, which is assumed to be determined by the depth of the planetary boundary layer (PBL) or fog depth.

### Summary of Accomplishments and Findings

Activities during this period focused on development, testing and delivery of the Version 5 (V5) Visibility Algorithm to the GOES-R Algorithm Working Group (AWG) Algorithm Integration Team (AIT). Equation (1) expresses visibility (V) in terms of optical depth ( $\tau$ ) and the thickness of the material layer (x),

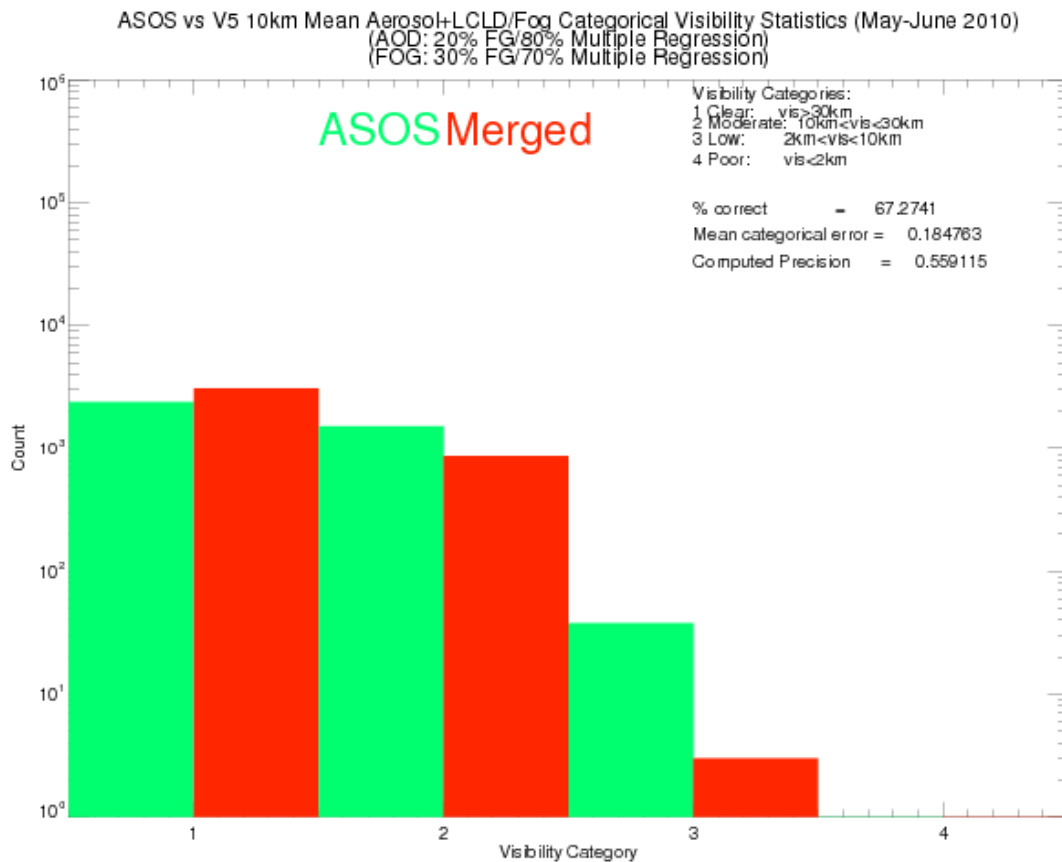
$$V = 3.0 / (\tau / x) \quad (1)$$

The ABI Visibility algorithm uses retrieved Aerosol Optical Depth (AOD) to estimate  $\tau$  under clear-sky conditions and uses retrieved Cloud Optical Thickness (COT) to estimate  $\tau$  under



cloudy conditions when fog or low clouds have been detected. In the Version 5 ABI aerosol visibility algorithm the Look Up Tables (LUT)'s are based on Version 5 MODIS AOD retrievals. Meteorological predictors are derived from the NOAA Global Forecasting System (GFS) Comprehensive Large Array-data Stewardship System (CLASS) archive. The aerosol and fog/low cloud LUT's include 12 sets of monthly multiple regression coefficients for both aerosol and fog/low cloud visibility retrievals. Optimal weighting between the first guess and multiple regression visibility estimates for aerosol and fog/low cloud visibility is determined based on assessment of required categorical accuracy (percent correct classification), required precision (standard deviation of categorical error), Heidke Skill Score (fractional improvement relative to chance), and False Alarm Rate.

The algorithm was validated using independent (not used in the LUT regression) ASOS visibility measurements and available ground, airborne, and space based cloud and aerosol extinction measurements. Merged GOES-R ABI visibility retrievals using MODIS proxy data have been validated against ASOS visibility measurements during May-June 2010. Figure 8.11.1 shows categorical histograms of the coincident ASOS and ABI merged visibilities. The merged aerosol and low-cloud/fog visibility retrieval results in a 67.3% categorical success rate for coincident ASOS/ABI measurement pairs during May-June 2010. The merged aerosol and fog/low cloud visibility retrieval overestimates the frequency of Clear visibility and underestimates the frequency of Moderate, Low and Poor visibility during this time period.



**Figure 8.11.1.** Categorical Histogram of Merged ABI (red) and ASOS (green) aerosol and fog/low cloud visibility for May-June 2010 coincident pairs.



Research also focused on developing Quality Assurance (QA) flags and metadata for the V5 Visibility retrieval based on aggregated 1km visibility retrieval statistics and input MODIS AOD, COT, and effective radius QA and updating the ATBD for delivery to AIT. In cooperation with AIT-Midwest, the V5 visibility retrieval was also integrated into GEOCAT. MODIS L2 cloud (MOD06/MYD06) and aerosol (MOD04/MYD04) and L1B radiance (MOD021KM/MYD021KM) data have been acquired from the NASA Level 1 and Atmosphere Archive and Distribution System (LAADS) for 2010 through 2012 and extended GEOCAT V5 visibility validation is ongoing.

The Visibility ATDB was revised and delivered to AIT on September 21, 2012. The Visibility ARR was conducted on September 24, 2012. The 100% Option 2 ATBD and Algorithm Package for Visibility was delivered by AIT on September 27, 2012.

### **Publications and Conference Reports**

Brunner, J., A. Lenzen, and R. B. Pierce, 2012: GOES-R AWG Visibility Retrieval, Air Quality Applied Sciences Team 3<sup>rd</sup> Meeting (AQA3T3), 13-15 June, Madison, Wisconsin.

Brunner, J., R. B. Pierce, and A. Lenzen, 2012: GOES-R AWG Visibility Retrieval, 37<sup>th</sup> National Weather Association Annual Meeting, 6-11 October, Madison, Wisconsin.

Brunner, J. C., B. Pierce, A. Lenzen, and J. Szykman, 2013: GOES-R AWG Visibility Retrieval and Visibility-Fires Analysis over Western United States for 2007-2008, 93<sup>rd</sup> American Meteorological Society Annual Meeting, Ninth Annual Symposium on Future Operational Environmental Satellite Systems, 5-10 January, Austin, Texas.

## **8.12. Imagery and Visualization**

**CIMSS Task Leaders: Tom Rink, David Santek**

**CIMSS Support Scientists: Mat Gunshor, Kaba Bah, Joleen Feltz**

**NOAA Collaborator: Tim Schmit**

**NOAA Long Term Goals**

- Weather-Ready Nation

**NOAA Strategic Goals**

- Serve society's needs for weather and water

**CIMSS Research Themes**

- Satellite Meteorology Research and Applications

### **Proposed Work**

The AWG Imagery Team has developed the format for ABI data which includes the fixed grid format and GRB-like data structure. Now in the validation phase, the next steps are to develop better methods by which ABI imagery will be quality controlled. Past efforts have primarily been theoretical approaches to data validation and now the project will move into practical applications of validation, perhaps testing on current GOES.

For visualization, McIDAS-V is CF-netCDF ready, meaning it understands the structure and semantics of CF conventions so the official product files of the GOES-R ABI can be immediately imported into the system without any additional programming. This free software is available to any scientist, researcher, or educator to analyze, visualize and synthesize with other data,





including past and current GOES, common meteorological in-situ observations, model forecast and reanalysis.

### **Background and Previous Work**

McIDAS-V is the fifth generation of McIDAS (the Man-computer Interactive Data Access System), and is a Java-based, open-source, freely available system. The software tool provides a powerful data manipulation and visualization environment to work with a large variety of geophysical data. McIDAS-V contains a flexible, extendable framework for integrating geophysical data into a very interactive 4D visualization and computation environment. This new functionality builds upon 40 years of McIDAS work and 10+ years of VisAD/IDV development.

Previous work is summarized below.

### **Imagery Product Development**

1. Regeneration of simulated GOES-R ABI meso/CONUS-scale netCDF files to meet updated requirements on calibration, quality flags and units definition.
2. Generated new CMIP files, as well as, GRB and validation files.
3. Iterated with Harris personnel verifying ABI Fixed Grid Format (FGF).
4. Demonstrated the impacts of a 17.76 vs. 17.4 degree view from nominal space position on images.
5. Provided internal validation for GRB-like files generated by the aerosol proxy team (calNex data).
6. Evaluated datasets from ITT-Exelis which were originally simulated by the AWG-Proxy team (WRF-model simulations) and then run through the ITT ABI instrument model.
7. Generated “triplet datasets” (FGF and GRB-like) for all three domains (Meso, CONUS, Full Disk) for use in the AIT Framework for testing algorithms (winds requires a triplet).
8. Delivered the Java-based FGF software to the GEOCAT team for integration.
9. Worked on FGF files for AIPS, generating 7 time periods of the three domains, where CONUS and Meso images are “cut outs” from the Full Disk.
10. Began integrating the guidelines in the PUG, which were new late in 2012.

### **Application of Data Integration and Validation Tools**

1. Derecho case study (29-30 June 2012) with winds, polar orbiting, and GOES retrieval products displayed in McIDAS-V.
2. Generated RGB composites in McIDAS-V, presented at a EUMETSAT Workshop on RGB Satellite Products: Standards, Applications and Opportunities. This included using a product for one color as opposed to just a satellite band.
3. Progress made on scripting in McIDAS-V such that images made of data delivered to GSP were generated with a McIDAS-V script and the Derecho case study was generated with a script as well.
4. Presentation at the EUMETSAT Satellite Conference of McIDAS-V use in the EUMETCast and GEONETCast Americas broadcasts.
5. Branson Tornado case study with polar orbiting and GOES sounder data.
6. Many McIDAS-V improvements including memory use, statistics, scripting, ADDE requests, data probes, and others.
7. McIDAS-V version 1.2 released. While this project is not the only funding source for McIDAS-V development, many improvements were made to McIDAS-V to meet the needs of the GOES-R Program.



## Summary of Accomplishments and Findings

- Continued product validation activities.
- Maintained and updated product algorithm.
- Continued development of product validation tools.
- Updated validation plan.
- Continued Verification Support to GOES-R Ground Segment Contractor (Harris/AER).
- Continued to work with CF-satellite working group on standards for multi-band, calibrated and navigated satellite data, using simulated ABI test cases as a working example. Develop utility classes to generate calibrated radiances.
- Enhanced McIDAS-V interface for spatial and temporal subsecting and animation.
- Improved the Python-based user-defined computation and scripting, including more robust background processing and development of higher-level user-friendly callable methods for common displays.
- Expanded specific McIDAS-V support for algorithm development, validation and evaluation to additional AWG algorithm teams through directly working with team members to identify their needs and improve our software tools.
- Supported development of product validation “tools”:
  - Developed scripts for routine product validation in McIDAS-V.
  - Implemented and demonstrated product validation scripts on current GOES (i.e., static and animated images of each band, posting to a Web site for visualization).
  - Implemented product validation scripts for routinely generated proxy data (i.e., static and animated images of each band, posting to a Web site for visualization).
  - Documented validation scripts for product validation tool ATBD.
- Supported Proxy team efforts by validation of proxy data output.
- Developed optimal strategies for efficient high-resolution imagery display (ongoing).
- Investigated and implemented new technologies when necessary to advance the system forward. For example, new 2D/3D rendering libraries, GPU computing to assist display and data fusion.
- Developed imagery algorithm to support the maintenance delivery (ongoing).
- Supported GOES-R Ground Segment Contractor Verification (on-going).
- Submitted monthly reports to Imagery and Visualization AWG Chairs (on-going).
- Continued working to generate GRB-like and CMIP files that meet the Product Definition.
- User’s Guide (PUG) Volume 4: GOES-R Rebroadcast requirements.

### 8.13. WRF-CHEM Aerosol and Ozone Proxy Data Simulations

**CIMSS Task Leader: Todd Schaack**

**CIMSS Support Scientist: Kaba Bah**

**NOAA Collaborator: R. Bradley Pierce**

**NOAA Long Term Goals**

- Weather-Ready Nation

**NOAA Strategic Goals**

- Serve society’s needs for weather and water

**CIMSS Research Themes**

- Satellite Meteorology Research and Applications
- Satellite Sensors and Techniques
- Environmental Models and Data Assimilation



## Proposed Work

The main focus of this project is to augment the current GOES-R AWG WRF Advanced Baseline Imager (ABI) proxy data capabilities with proxy datasets for aerosols and ozone. The aerosol and ozone proxy datasets are generated with WRF-CHEM air quality simulations (Grell et al., 2005) coupled to global chemical and aerosol analyses from the Real-time Air Quality Modeling System (RAQMS) (Pierce et al., 2007). Chemical data assimilation is used to provide observational constraints on the global chemical and aerosol analyses. Output from the coupled RAQMS/WRF-CHEM ozone and aerosol simulations are used to construct simulated radiances using the NOAA Community Radiative Transfer Model (CRTM) (Han et al., 2006). The addition of aerosol and ozone distributions into the WRF proxy dataset will allow generation of synthetic radiances for all ABI bands and thus facilitate the development of algorithms supporting retrievals of aerosol properties (optical depth, aerosol type, effective radius, fine vs. coarse mode fraction), total column ozone, and detection of dust, smoke and SO<sub>2</sub>. This work is conducted in close collaboration with the existing GOES-R WRF proxy data simulation team at CIMSS (Lead, Allen Huang, CIMSS)

## Summary of Accomplishments and Findings

FY2012 WRF-CHEM Aerosol and Ozone proxy data activities focused on providing real-time nested WRF-Chem/RAQMS meteorological, chemical, and aerosol forecasts to support generation of proxy radiances for all ABI bands as part of the GOES-R AWG Real-time Proxy Framework Support effort. WRF-Chem/RAQMS forecasts provide the input for generation of synthetic ABI radiances for all ABI bands generated using the CRTM under the “Real-time Proxy Framework Support: CRTM/GEOCAT/GRB Components” task (see 8.1 of this report). Combined, these two tasks support GOES-R ABI pre-launch activities by providing real-time GOES Rebroadcast (GRB) files containing synthetic ABI radiances in real-time. The GRB files are being distributed to AIT and Proving Ground partners for testing GOES-R algorithms and data systems. WRF-Chem simulations are archived and used for algorithm validation.

WRF-Chem version 3.3.1 is used to produce the high temporal and spatial resolution forecasts required for this effort. The 36 hour WRF/Chem forecasts are run daily over CONUS at 8 km horizontal resolution with 34 vertical layers. These WRF/Chem forecasts include near real time biomass burning emissions and high resolution anthropogenic emissions. The last 24 hours of the forecasts provide the required input for the CRTM. Meteorological initial conditions (ICs) and lateral boundary conditions (LBCs) are provided by the NCEP GFS forecasts. Aerosol ICs, LBCs and ozone are provided from daily 1x1 degree global RAQMS forecasts performed at CIMSS. Both WRF-Chem and RAQMS include on-line aerosol modules from the Goddard Global Ozone Chemistry Aerosol Radiation and Transport (GOCART) model [Chin et al., 2002]. The addition of aerosol and ozone distributions into the CRTM input stream allows generation of more realistic synthetic (proxy) radiances for all ABI bands.

Substantial effort has been devoted to providing the best possible WRF/Chem input for the CRTM. It was determined that 8 km horizontal resolution is the highest possible WRF/Chem model resolution that can be employed to ensure the end to end WRF/Chem – CRTM – GRB files processing stream completes on time. Numerous sensitivity runs were performed to determine the vertical resolution used and the model physics employed in WRF/Chem. These efforts led to the use of the same vertical structure and model physics as used by NOAA/NSSL WRF. 8 km horizontal resolution lies in the grey area of whether or not to employ a moist convective scheme in the model forecasts. A series of sensitivity studies led to the determination that running WRF/Chem without a moist convective parameterization provides the best model input for the CRTM.



Comparison of the synthetic radiances produced by the CRTM with GOES observations (as part of this joint effort) revealed large biases in synthetic radiances for the 3.9 micron channel (a channel sensitive to both IR and solar radiation). It was first determined that the CRTM V2.1 does not account for solar reflectance in the 3.9 radiance calculation as required for this band (we have submitted a ticket to the CRTM developers about this problem). It was then determined that the microphysics scheme used in the WRF/Chem (WSM 6-class graupel scheme as adopted from the NSSL WRF setup) produced too high ice mixing ratios in cirrus clouds leading to substantial brightness temperature (Tb) warm biases for the 3.9 micron band in cloudy regions when using a version of CRTM V2.1 modified to include solar reflectance in the 3.9 micron radiance calculations. Figure 8.13.1a shows scatter plots of WRF/Chem-CRTM synthetic Tb where the WSM6 microphysics scheme was employed versus GOES-13 Tb. The figure shows poor correspondence between distributions with near constant values of synthetic Tb near 295K resulting from the high ice cloud mixing ratios produce with the WSM6 scheme. A series of forecast experiments showed that the WRF/Chem Thompson graupel microphysics scheme significantly reduced the predicted cirrus cloud ice mixing ratios compared to the WSM6 scheme. Figure 8.13.1b shows greatly improved comparison (relative to WSM6) with GOES Tb for both high and low clouds. The daily processing stream has been modified to use the Thompson microphysics scheme in WRF/Chem and a modified CRTM V2.1 which includes solar reflectance in the 3.9 micron radiance calculations.

### **Publications and Conference Reports**

Greenwald, T., B. Pierce, J. Otkin, T. Schaack, J. Davies, E. Borbas, M. Rogal, K. Bah, G. Martin, J. Nelson, J. Sieglaff, W. Straka, and H.-L. Huang, 2013: Near-real-time simulated ABI imagery for user readiness, retrieval algorithm evaluation and model verification, 93<sup>rd</sup> American Meteorological Society Annual Meeting, Ninth Annual Symposium on Future Operational Environmental Satellite Systems, 5-10 January, Austin, Texas.

Rogal, M., K. Bah, T. Greenwald, B. Pierce, A. Lenzen, J. Nelson, J. Otkin, T. Schaack, J. Davies, E. Borbas, J. Sieglaff, and H.-L. Huang, 2013: Near-real-time validation of simulated GOES-R ABI radiances and derived products using the WRF-Chem model forecast over CONUS for all 16 ABI bands, NOAA Satellite Science Week, virtual meeting, 18-22 March.

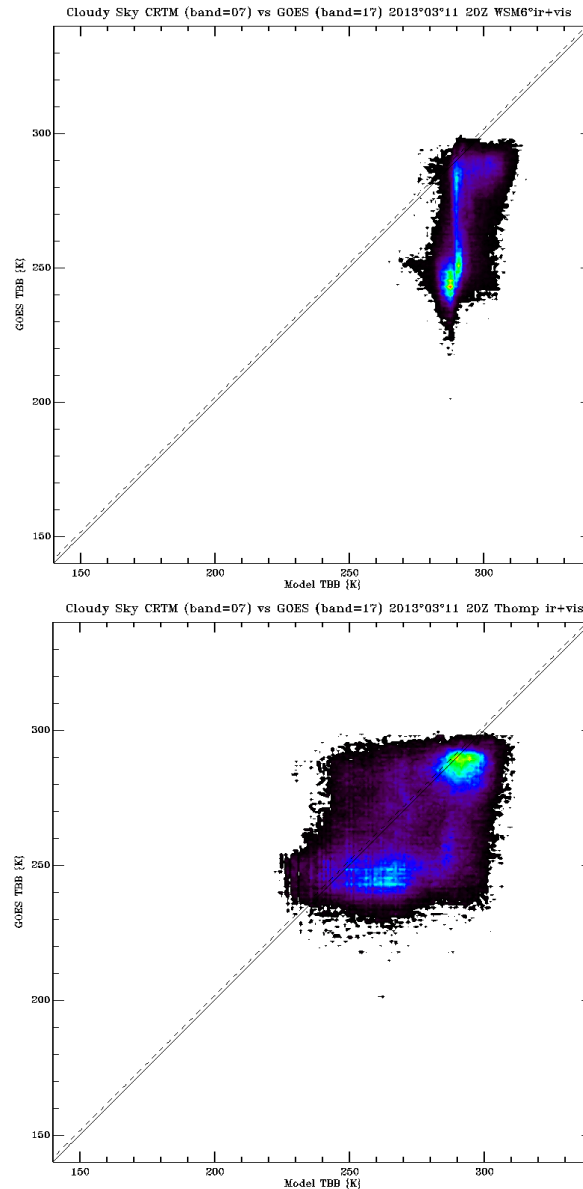
### **References**

Chin, M., et al., Tropospheric aerosol optical thickness from the GOCART model and comparisons with satellite and sunphotometer measurements, *J. Atmos. Sci.* 59, 461-483, 2002.

Grell, G. A., et al., Fully coupled online chemistry within the WRF model. *Atmos. Environ.*, **39**, 6957-6975, 2005.

Han, Y., et al., Community Radiative Transfer Model (CRTM) - Version 1. NOAA Technical Report 122, 2006.

Pierce, R. B., et al. (2007), Chemical data assimilation estimates of continental U.S. ozone and nitrogen budgets during the Intercontinental Chemical Transport Experiment–North America. *J. Geophys. Res.*, **112**, D12S21, doi:10.1029/2006JD007722.



**Figure 8.13.1.** Scatter plots for 20Z March 11, 2013 of CRTM/WRF-Chem synthetic vs. GOES-13 ABI 3.9 micron brightness temperatures for (a) WRF/Chem using WSM6 microphysics package and (b) Thompson microphysics package for cloudy scenes.

## 9. CIMSS Participation in the GOES-R Risk Reduction Program for 2012

### 9.1. Development of a GOES-R Automated Volcanic Cloud Alert System

**CIMSS Task Leader: Justin Sieglaff**  
**NOAA Collaborator: Michael Pavolonis**  
**NOAA Long Term Goals**

- Weather-Ready Nation



## **NOAA Strategic Goals**

- Support the nation's commerce with information for safe, efficient and environmentally sound transportation

## **CIMSS Research Themes**

- Satellite Meteorology Research and Applications
- Satellite Sensors and Techniques
- Environmental Models and Data Assimilation

## **Proposed Work**

The GOES-R volcanic ash and SO<sub>2</sub> products developed by the Algorithm Working Group (AWG) provide valuable information on volcanic ash cloud height and mass loading, as well as information on the presence of SO<sub>2</sub> clouds. The products, however, are not designed (or required) to issue text alerts to forecasters when a volcanic cloud (ash and/or SO<sub>2</sub>) is identified. Text alerts are critical for ensuring that the GOES-R capabilities are fully utilized in the effort to address the 5-minute volcanic cloud warning criteria established by the international aviation community, as forecasters cannot constantly manually analyze GOES-R imagery and products in real-time. As such, we proposed to develop an automated volcanic cloud alert system for GOES-R. More specifically, we proposed to utilize the output of the official GOES-R volcanic ash, SO<sub>2</sub>, and lightning detection algorithms in combination with a sophisticated, but computationally efficient, scheme to identify volcanic clouds with skill comparable to that of a human analyst. When a volcanic cloud is identified, a text alert with quantitative information on the physical properties of the cloud, along with a quicklook product image, will be issued. The proposed alert system will build upon the automated ash cloud alert system developed by NOAA/NESDIS/STAR for the Advanced Very High Resolution Radiometer (AVHRR). Unlike the AVHRR system, the GOES-R system will be capable of identifying SO<sub>2</sub> clouds and identifying volcanic ash clouds with greater accuracy. The GOES-R system will also be able to take advantage of temporal information. The Spinning Enhanced Visible/Infrared Imager (SEVIRI) and the Moderate Resolution Imaging Spectroradiometer (MODIS) will be used as proxy for GOES-R Advanced Baseline Imager (ABI) data, and a ground-based lightning detection network will be used as a proxy for the GOES-R Lightning Mapper (GLM). M. Pavlonis (NOAA/NESDIS/STAR) led the development of the official GOES-R volcanic ash and SO<sub>2</sub> products, and will lead the development of the proposed automated alert system at the Cooperative Institute for Meteorological Satellite Studies (CIMSS) with Co-I J. Sieglaff. Co-I Ronald Thomas (New Mexico Tech) will provide the proxy GLM data and lightning network expertise. Co-I Nathan Eckstein (SOO, Alaska Aviation Weather Unit) will coordinate the user feedback component of the development process. The Anchorage and Washington Volcanic Ash Advisory Centers support the proposed activities, which are well aligned with the goals of the NOAA Volcanic Ash Working Group (VAWG) (M. Pavlonis is a member of the VAWG).

## **Summary of Accomplishments and Findings**

During the past year, we have developed a Web site to host imagery associated with volcanic cloud alerts. All alerts are stored in a searchable database. Figure 9.1.1 shows a screen capture of alert text and imagery from the Web site for a given alert event. The Web site also contains sectorized imagery of active volcanic regions within the Washington DC and Anchorage, Alaska Volcanic Ash Advisory Centers (VAAC) regions of responsibility. The sectorized imagery combines both polar orbiting and geostationary imagery in customizable time loops. The alert system and sectorized imagery is currently being run in real-time at UW-Madison/CIMSS using observations from MODIS, AVHRR, SEVIRI, and GOES.



In addition to creating the Web site for hosting the output from the alerting system, several science improvements have been completed. The temporal component of the ash detection methodology has been implemented. This component of the system allows optically thin ash clouds to be automatically identified without degrading the detection accuracy. The ash detection criteria were refined to allow for more skillful detection over desert surfaces. Historical and near-realtime data processing were used to estimate the false alarm rate of the alert system. The results indicate that false alerts are quite rare (less than 1 per week) and generally only occur over high elevation desert surfaces like the Atacama Desert in Chile. An automated procedure for identifying and filling artificial holes in ash clouds caused by complexities like multiple cloud layers was developed and implemented. The Co-Is at New Mexico Tech developed a GLM proxy dataset using a ground-based lightning detection array that was located in Southern Iceland during the 2010 eruption of Eyjafjallajökull. This will enable the alert system to include GLM data for detecting lightning producing volcanic eruptions. Lastly, the output from the alert system is being used to conduct automated model initialization experiments with the HYSPLIT dispersion model.

M. Pavolonis visited the Japanese Meteorological Agency (JMA) (Tokyo VAAC) and the Australian Bureau of Meteorology (BoM) (Darwin VAAC) in the past year to present the latest GOES-R volcanic cloud products, including automated alerts. Both institutes are interested in evaluating the GOES-R volcanic cloud products. Additionally, the VAACs from Montreal, Toulouse, and Wellington have expressed interest in gaining access to the GOES-R volcanic ash products.

### **Publications and Conference Reports**

Pavolonis, M. J., A. K. Heidinger, and J. Sieglaff (2013), Automated retrievals of volcanic ash and dust cloud properties from upwelling infrared measurements, *J. Geophys. Res. Atmos.*, 118, doi:[10.1002/jgrd.50173](https://doi.org/10.1002/jgrd.50173).

### **References**

Pavolonis, M. J., 2010: Advances in extracting cloud composition information from spaceborne infrared radiances: A robust alternative to brightness temperatures. Part I: Theory. *J. Applied Meteorology and Climatology*, **49**, 1992-2012.

Pavolonis, M. J., 2011: Advances in extracting cloud composition information from spaceborne infrared radiances: A robust alternative to brightness temperatures. Part II: Proof of concept. To be submitted to: *J. Applied Meteorology and Climatology*.

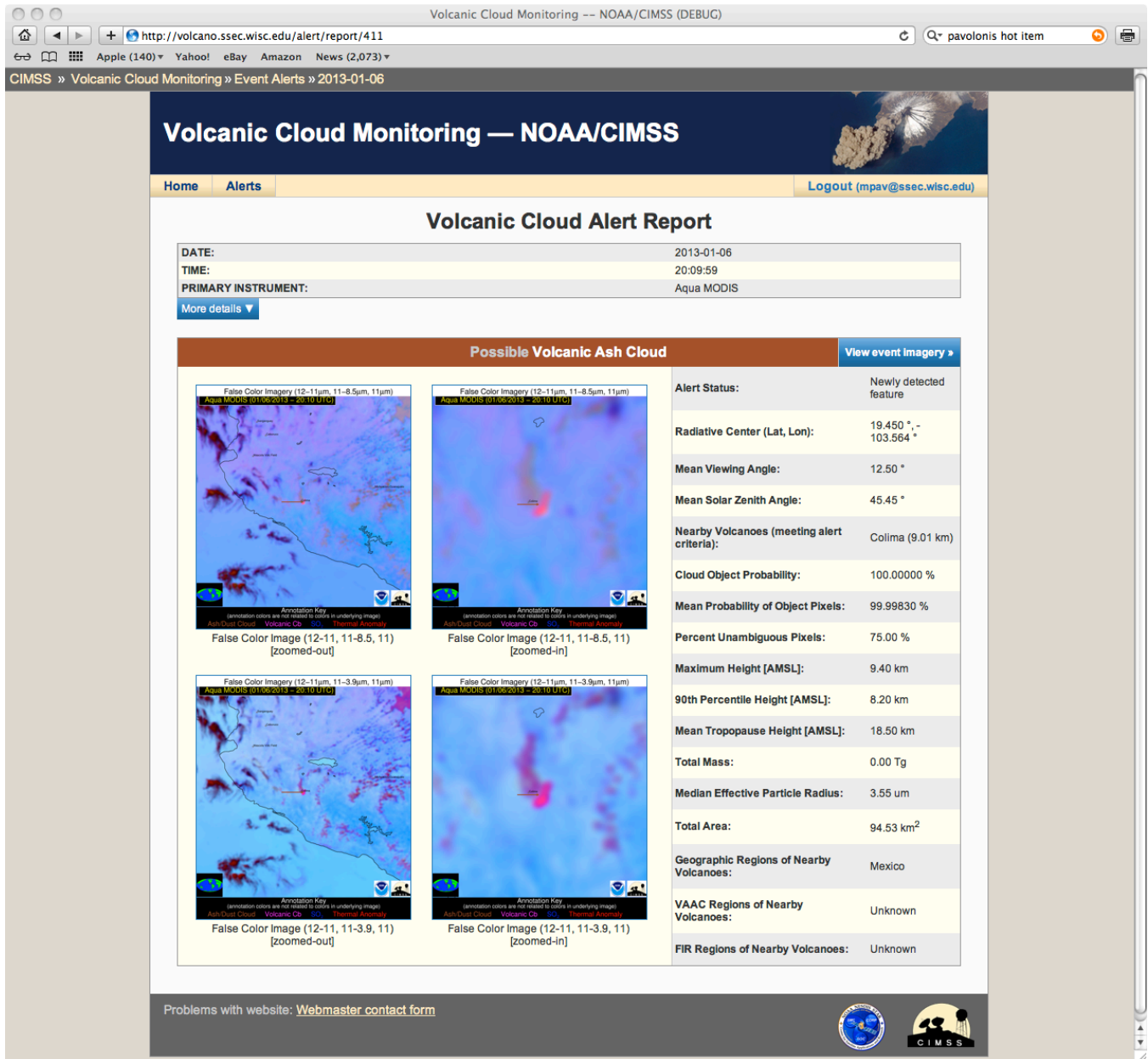


Figure 9.1.1. An example of alert text and imagery as displayed on the Web.

## 9.2. Integrated GOES-R GLM/ABI Approaches for the Detection and Forecasting of Convectively Induced Turbulence

**CIMSS Task Leader: Wayne Feltz**

**CIMSS Support Scientists: Sarah Monette and Tony Wimmers**

**NOAA Collaborator: Tim Schmit**

**External Collaborators: Kristopher Bedka (NASA SSAI) and Larry Carey (University of Alabama – Huntsville)**

**NOAA Long Term Goals**

- Weather-Ready Nation





## **NOAA Strategic Goals**

- Serve society's needs for weather and water
- Support the nation's commerce with information for safe, efficient and environmentally sound transportation

## **CIMSS Research Themes**

- Satellite Meteorology Research and Applications

## **Proposed Work**

Convectively induced turbulence (CIT), icing and lightning are all potential in-flight aviation hazards that require aircraft to avoid thunderstorms in order to mitigate the risk of passenger injury and/or aircraft damage. As noted in the Federal Aviation Administration (FAA) Aeronautical Information Manual (AIM, 2010) convective updrafts, downdrafts and their effects (e.g., gravity waves) make up a turbulent system that can extend far beyond the visible and radar detectable boundaries of thunderstorms (Heymsfield et al., 1991; Lane et al., 2003). As such, current FAA guidelines in the AIM (2010) suggest that aircraft avoid severe thunderstorms by at least 20 miles, including under anvil regions and above thunderstorm tops. As a result, large regions of airspace can become unavailable to aircraft traffic on days of widespread convection, causing long flight delays. From FAA statistics, Weber et al. (2006) estimate that thunderstorm related flight delays cost the commercial airline industry approximately two billion dollars annually in direct operating expenses. According to the Bureau of Transportation Statistics (BTS), 66% of National Aviation System (NAS) delays were due to weather, of which thunderstorms are likely a major contributor, while NAS delays were 31% of total flight delays in 2009. Furthermore, turbulence was a cause or factor in 22% of all large commercial aircraft accidents and produced half of the serious-injury accidents from 1997-2006 (National Traffic Safety Board 2010). Importantly, CIT in and around thunderstorms is likely responsible for over 60% of turbulence-related aircraft accidents (e.g., Cornman and Carmichael 1993; Kaplan et al., 2005; Sharman and Williams 2009).

To increase flight safety and decrease delays, it is necessary to develop multi-sensor based algorithms to diagnose the likelihood of CIT and other aviation hazards associated with thunderstorms. Such automated guidance could be used by pilots, dispatchers and air traffic controllers to support the next-generation air transportation system (NextGen) goals of significantly increasing air traffic capacity over the next 20 years (e.g., Sharman and Williams 2009). To be effective, an automated algorithm should use multi-parameter, and if possible, multi-sensor inputs that are widely available and physically and statistically correlated to the thunderstorm microphysics and kinematics that cause aviation hazards. Recent studies utilizing Doppler radar, cloud-to-ground (CG) lightning, satellite IR and/or numerical weather data separately or in combination have shown early promise in providing useful diagnostic and short-term predictive capability of CIT and other thunderstorm related aviation hazards (e.g., Evans et al., 2004; Megenhardt et al., 2004; Williams et al., 2005, 2006, 2007, 2008, 2009; Feltz et al., 2006; Wolfson and Clark 2006; Yee et al., 2006; Bedka et al., 2007, 2010; Iskenderian 2008; Sharman and Williams 2009).

Combined observations from the planned Geostationary Operational Environmental Satellite-R (GOES-R) series GLM and ABI instruments will provide an unprecedented opportunity to improve the multi-sensor diagnosis and short-term forecasting of CIT and other thunderstorm related aviation hazards. The proposed research will leverage and combine proven capabilities of current members of the GOES-R Risk Reduction (GOES-R3) Lightning Team (Carey, Petersen) and the GOES-R Aviation Algorithm Working Group (AWG) (Feltz, Bedka) in using GLM and ABI proxy cloud top cooling, OT/enhanced-V, and total lightning flash rates and trends for the



identification of hazardous convective weather. These distinct yet complementary research capabilities will be synthesized to develop knowledge and techniques toward the goal of demonstrating a new, gap-filling GOES-R integrated GLM/ABI CIT aviation hazard product.

CIT is tied directly and indirectly (via gravity wave production) to the evolution of thunderstorm updraft characteristics (e.g., intensity, diameter, depth, and lifecycle). Lightning flash occurrence and rate provide important metrics of updraft intensity, vertical structure and lifecycle that should complement IR satellite observations. As such, an important first step in this research will be the establishment of the temporal and spatial relationship between EDR turbulence reports, total lightning occurrence and flash rate/density, OT occurrence and IR cloud-top cooling as was recently accomplished for OTs, NLDN CG flashes and EDR reports in Bedka et al. (2010). Gravity waves, which can generate CIT at large distances from storms, are produced when rapid convective development subsequently results in the updraft overshooting the level of neutral buoyancy and rapidly decelerating (Lane et al., 2001, 2003). It is hypothesized that rapid IR cloud-top cooling and a jump in the total lightning flash rate are followed by OT occurrence and associated gravity wave production and increased CIT potential.

Therefore, carefully documenting and analyzing the temporal co-evolution of these GLM-ABI updraft intensity metrics from a significant sample of hazardous storms with EDR reports are the next key steps. Trends of integrated GLM-ABI metrics of convective intensity will be obtained by using multi-sensor cell (object)-oriented tracking tools in the NSSL Warning Decision Support System–Integrated Information (WDSS-II) software package (Lakshmanan et al., 2007, 2009). The co-evolving trends of lightning-IR intensity metrics leading up to EDR CIT events of various intensities (light, moderate, severe, extreme) in a large number of storms over LMAs will provide the primary basis for developing integrated GLM-ABI methodologies. By incorporating TRMM LIS/VIRS total lightning/IR overpass data when available and ground-based CG lightning data from LF/VLF networks (such as Vaisala’s NLDN and Global Lightning Data set, GLD-360, which is currently being assessed against LIS and LMAs in ongoing risk reduction research at NSSTC) into these LMA studies, the GLM-ABI proxy results could possibly be extended to locations away from LMAs, such as over remote oceans and mountains. Since environmental conditions (e.g., stability and wind shear) affect gravity wave production associated with deep convection (Lane et al., 2003), we will use sounding or model analysis parameters to provide meteorological context for a better understanding of the relationship between CIT occurrence and GLM-ABI intensity metrics.

### **Summary of Accomplishments and Findings**

Research continues to refine relationships between GOES-R convective intensity metrics (lightning, IR, visible) and the occurrence of Convectively Induced Turbulence (CIT) in varied environments.

In addition, work has been done to determine the predictability of CIT in the region of cloud-top cooling (CTC) events. A Bayesian scheme for predicting turbulence near a CTC will be compared to climatology through a probability analysis as well as a yes-no analysis. This is done in accordance with the project milestone “Establish temporal and spatial relationships between...cloud top cooling...and EDR\_CIT events.” Initial analysis has found this scheme to be skilful with respect to climatology.

The co-evolution of total-lightning, radar-derived fields, and GOES-14 1-min SRSO observations and overshooting top (OT) detections were analyzed for two individual long-lived and severe convective storm cells. The analysis showed that rapid GOES IR cloud-top cooling (CTC) was

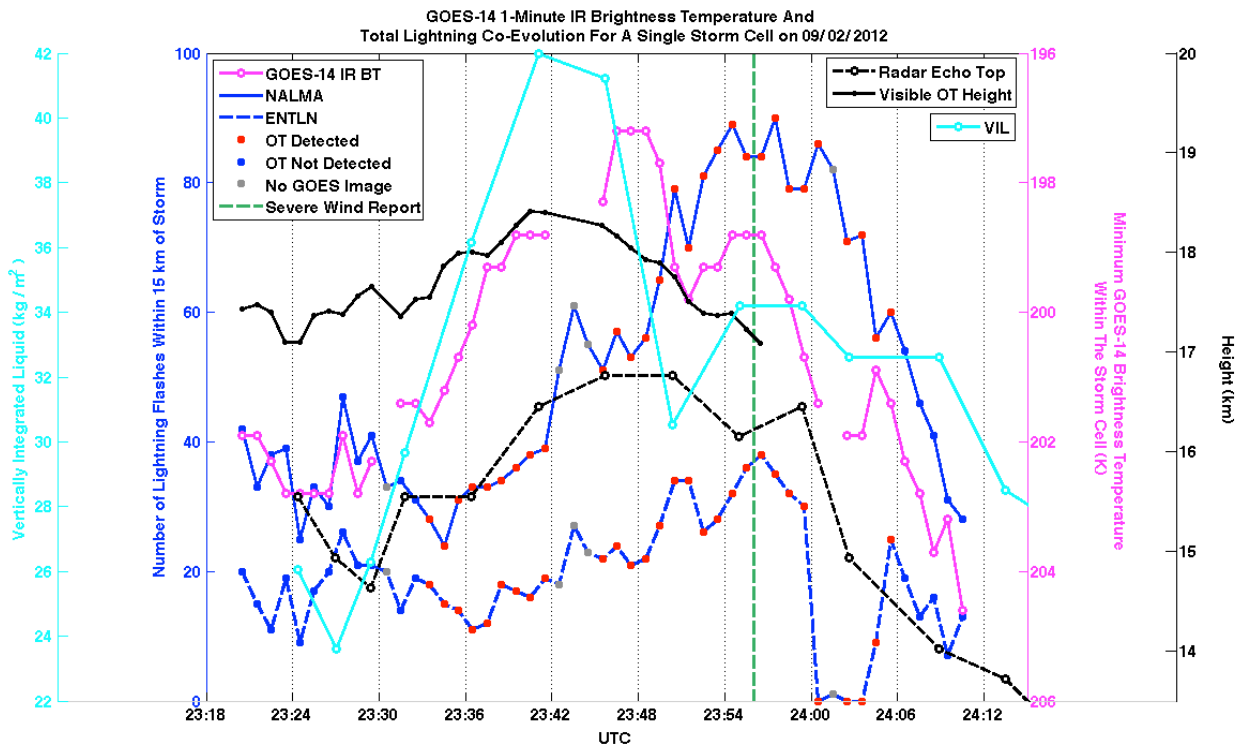


well correlated with a rapid increase in total lightning flash rates in both storms. OTs were repeatedly detected while the storms were producing lightning and severe weather and discontinuation of OT detections signaled storm decay.

1. Have established a relationship between EDR-CIT and CTC through a Bayesian scheme that is skilful at predicting CIT with respect to climatology at predicting EDR-CIT within the near future (7 minutes).
2. Continued examination of cases in which total lightning offers valuable flight routing information.
  - Numerous cases identified in which aircraft attempt to navigate the gap between convective cells and then experience moderate or greater turbulence (via EDR report).
  - Multiple cases where inclusion of total lightning data could have offered enhanced turbulence avoidance guidance over radar alone.
3. Conducted multi-platform comparison of convective strength metrics for a severe thunderstorm during SRSO event in North Alabama 09-02-2013 (see Fig. 9.2.1, top).
  - Total lightning data and trends from Earth Networks Total Lightning Network (ENTLN) were gathered and compared to output from the Northern Alabama Lightning Mapping Array (NALMA) for this SRSO case. Trends between networks are similar though there are significant differences in flash count magnitude. ENTLN flash rates are biased low relative to the NALMA.
  - The storm center was identified using 1-minute resolution lightning flash detections from the NALMA and compared to centroid data from WDSS-II tracking for consistency.
  - The minimum GOES-14 IR brightness temperature (BT) and the presence of an OT detection were noted from each 1-minute image.
  - Vertical penetration magnitude of an OT was derived for the 2-3 September case by measuring the length of the shadow that the OTs cast upon the surrounding anvil.
  - The WSR-88D vertically integrated liquid (VIL), enhanced echo top, and reflectivity time-height cross section were derived from WDSS-II cell tracks of the storm cells of interest.
4. Multi-platform comparison of convective strength metrics for a severe thunderstorm during SRSO event in Missouri and Illinois on 08-16-2013 (see Fig. 9.2.1, middle and bottom).
  - Lack of LMA coverage in this region precludes another comparison between ENLTN and LMA flash data and trends.
  - Similar to the 2 September SRSO case, the first OT detections signaled the beginning of storm intensification and rapid CTC occurred in conjunction with a sharp increase in ENTLN flash rates.
  - CTC occurred at 2020 UTC, approximately 10 mins before a 2.5 inch hail report.
  - At the time of severe hail, ENTLN total lightning and GOES IR BT suggested a weakening of the storm updraft that may have allowed large hail present aloft to fall to the surface.
  - Though no severe weather was reported from 2040-2200 UTC, the storm re-intensified and featured colder IR BT and greater ENTLN flash rates than the first half of the storm lifetime.
5. We hope to identify a long-lived tornadic storm observed by GOES-14 SRSO (if one occurred) and perform a similar analysis to that above, ideally in high solar zenith angle



conditions so that OT penetration height could be inferred from visible channel shadow length (Figure 9.2.1).



**Figure 9.2.1.** The co-evolution of total-lightning, radar-derived fields, and GOES-14 1-min SRSO observations and overshooting top (OT) detections were analyzed for two individual long-lived and severe convective storm cells. (top) A storm over Northern Alabama on 2-3 September 2012 (middle) storm over the Illinois/Missouri border region, 75 miles southeast of St. Louis, on 16 August 2012 from 1915-2040 UTC and (bottom) from 2041-2200 UTC.

### Publications and Conference Reports

Identification of Convectively-Induced Aircraft Turbulence using Satellite Data, Sarah A. Monette, Kristopher M. Bedka, and Wayne F. Feltz. American Meteorological Society Annual Meeting, Austin, TX. Jan 6-10, 2013.

Total Lightning in a Multi-sensor Approach to the Detection and Forecasting of Convectively Induced Turbulence, Ryan Rogers, Larry Carey, Kris Bedka, Cecilia Fleegeer, Wayne Feltz, Sarah Monette. American Meteorological Society Annual Meeting, Austin, TX. Jan 6-10, 2013.

The GOES Objective Overshooting Top Signature Detection Product: Algorithm Description, Validation, and Applications, Kristopher Bedka, Richard Dworak, Lee Cronce, and Wayne Feltz. 2nd National Weather Service Eastern Region Virtual Satellite Workshop, February 26, 2013.

Total Lightning in a Multi-sensor Approach to the Detection and Forecasting of Convectively Induced Turbulence, Ryan Rogers, Larry Carey, Kris Bedka, Cecilia Fleegeer, Wayne Feltz, Sarah Monette. NOAA Satellite Science Week Virtual Meeting, March 18-22, 2013



Analysis of the Co-Evolution of Total Lightning, Ground-Based Radar-Derived Fields, and GOES-14 1-Minute Super Rapid Scan Satellite Observations of Deep Convective Cloud Tops, Kristopher Bedka, Cecilia Fleegeer, Ryan Rogers, Larry Carey, Wayne Feltz, and Jan Kanak. NOAA Satellite Science Week Virtual Meeting, March 18-22, 2013

### Journal Articles

Monette, S. A. and W. F. Feltz, 2013: Using Cloud Top Cooling to Predict Aircraft Turbulence. *J. Appl. Meteor. Climatol.*, In preparation.

### References

Bedka, K., W. Feltz, J. Mecikalski, R. Sharman, A. Lenz, and J. Gerth, 2007: Satellite signatures associated with significant convectively-induced turbulence events. Proc. Joint Meteorological Satellite and 15<sup>th</sup> Satellite Meteorology and Oceanography Conf., Amsterdam, Netherlands, EUMETSAT and Amer. Meteor. Soc.

Bedka, K., J. Brunner, R. Dworak, W. Feltz, J. Otkin, and T. Greenwald, 2010: Objective satellite-based detection of overshooting tops using infrared window channel brightness temperature gradients. *J. Appl. Meteor. Climatol.*, **49**, 181-202.

Bedka, K. M., R. Dworak, J. Brunner, and W. Feltz, 2011: Validation of satellite-based objective overshooting top detection methods using CloudSat Cloud Profiling Radar observations. In Preparation for *J. Appl. Meteor. and Climatol.*

Carey, L. D., and S. A. Rutledge, 1996: A multiparameter radar case study of the microphysical and kinematic evolution of a lightning producing storm. *Meteor. Atmos. Phys.*, **59**, 33–64.

Carey, L. D., and S. A. Rutledge, 1998: Electrical and multiparameter radar observations of a severe hailstorm. *J. Geophys. Res.*, **103**, 13,979–14,000

Carey, L. D., and S. A. Rutledge, 2000: The relationship between precipitation and lightning in tropical island convection: A C-Band polarimetric radar study. *Mon. Wea. Rev.*, **128**, 2687–2710.

Goodman, S. J., D. E. Buechler, P. D. Wright, and W. D. Rust, 1988: Lightning and precipitation history of a microburst producing storm. *Geophys. Res. Lett.*, **15**, 1185-1188.

Goodman, S. J., and co-authors, 2005, The North Alabama lightning mapping array: Recent severe storm observations and future prospects, *Atmos. Res.*, **76**(1–4), 423–437.

Feltz, W. F., K. Bedka, A. Wimmers, M. Pavolonis, S. Bedka, S. A. Ackerman, J. R. Mecikalski, J. J. Murray, and D. B. Johnson, 2006: Satellite derived products to enhance aviation nowcasting of convection, turbulence, and volcanic ash. 14th Conference on Satellite Meteorology and Oceanography. Atlanta, GA, Amer. Meteor. Soc., 7.2.

Lakshmanan, V., T. Smith, G. J. Stumpf, and K. Hondl, 2007: The Warning Decision Support System – Integrated Information. *Wea. and Forecasting*, **22**, 596-612.

Lakshmanan, V., K. Hondl, and R. Rabin, 2009: An efficient, general-purpose technique for identifying storm cells in geospatial images. *J. Atmos. Oceanic Tech.*, **26**, 523-537.



Mecikalski, John R. and Bedka, Kristopher M., 2006: Forecasting convective initiation by monitoring the evolution of moving cumulus in daytime GOES imagery. *Mon. Wea. Rev.*, **134**, 49-78.

Petersen, W. A., Christian, H. C., and S. A. Rutledge, 2005: TRMM Observations of the global relationship between ice water content and lightning. *Geophys. Res. Lett.*, **32**, L14819, doi:10.1029/2005GL023236.

Wimmers, A. J., and co-authors, 2003: Signatures of tropopause folding in satellite imagery. *J. Geophys. Res.*, **108**, NO. D4, 8360, doi:10.1029/2001JD001358.

### 9.3. Investigating the Effects of Detector-Averaged SRFs

**CIMSS Task Leader: Mathew M. Gunshor**

**CIMSS Support Scientist: Szuchia Moeller**

**NOAA Collaborator: Timothy J. Schmit**

**NOAA Long Term Goals**

- Weather-Ready Nation

**NOAA Strategic Goals**

- Serve society's needs for weather and water
- Provide critical support for the NOAA mission

**CIMSS Research Themes**

- Satellite Meteorology Research and Applications
- Satellite Sensors and Techniques

#### Proposed Work

To study the effects of using detector-averaged SRFs on current GOES, the GOES sounder will be utilized. The analysis will involve fast forward model radiative transfer calculations, using 32 RAOB atmospheres used previously for RTM training at CIMSS (informally known as the CIMSS-32), which contain a variety of atmosphere types from dry to wet and cold to hot. The fast forward model will be the PFAAST model. Transmittance coefficient files will be generated for PFAAST that are built from individual detector SRFs (those files are already available for detector-averaged SRFs). The differences in calculated radiance and brightness temperature between individual detector SRFs and detector averaged SRFs will be determined. These values can be compared to the measured and spec noise for each channel.

The first task proposed will be used to generate the methodology by which GOES-R ABI SRFs can be analyzed. The analysis will serve as the proof-of-concept for this methodology. By doing forward model calculations on a variety of atmosphere types, it is believed that the differences in the individual detector's measurements can be determined.

The future funding allows, later an analysis could involve the generation of the Cloud Top Pressure (CTP) product using the GOES Sounder. This product is affected by striping in the sounder, the effects of which could possibly be mitigated in the future if individual detectors were considered. For this product, the fast forward model developments will be used to generate CTP using an individual detector forward model. This altered product will be compared to the typically generated product (using detector-averaged SRFs).



## Summary of Accomplishments and Findings

The adaptation of PFAAST for individual SRF analysis is underway and coincides with a reorganization of PFAAST code. PFAAST is older software and was not written in a way to take advantage of today's multiple processor computers. Also, PFAAST was written as individual versions for each satellite scientists wanted to use it for. The result is that there is a great deal of duplicated code. Currently the code infrastructure is being reorganized to better reflect today's standards and to consolidate it so that one driver function can be used to generate forward model calculations for any of the satellites we have spectral response functions for (which includes the host of NOAA GOES and POES satellites as well as the instruments from our partner international agencies). This should make PFAAST easier to use and more practical to implement across a range of current and future GOES projects. PFAAST is the forward model being used for the generation of current operational GOES and POES products. It is also used operationally around the world and will be used for China's future hyper spectral sounder. While this code overhaul is outside the original scope of this project and is primarily funded by other projects at SSEC/CIMSS, it has slowed progress for this project.

It was decided the first task of quantifying the detector-to-detector differences and comparing them to the noise could be done another way: convolving the individual detector SRFs with the CIMSS-32 atmospheres. A poster was presented at the NOAA Satellite Science Week in Kansas City, MO in May of 2012 highlighting some of the findings of this study so far, using the method of convolution. Since the Sounder has four detectors per infrared band, as compared to only two for the Imager, the focus was on the Sounder to determine what the detector-to-detector differences are for each band. The poster showed the results from convolving with the US Standard Atmosphere, which is enough to demonstrate the variability between detectors for some sounder bands. It was demonstrated that even if detector-to-detector differences are larger than the noise in radiance space, the differences in temperature space might be less than the noise if individual detector SRFs are used in the conversion from radiance to temperature. If a detector-averaged SRF is used in that conversion, then differences larger than the noise in radiance space are also larger than the noise in temperature space.

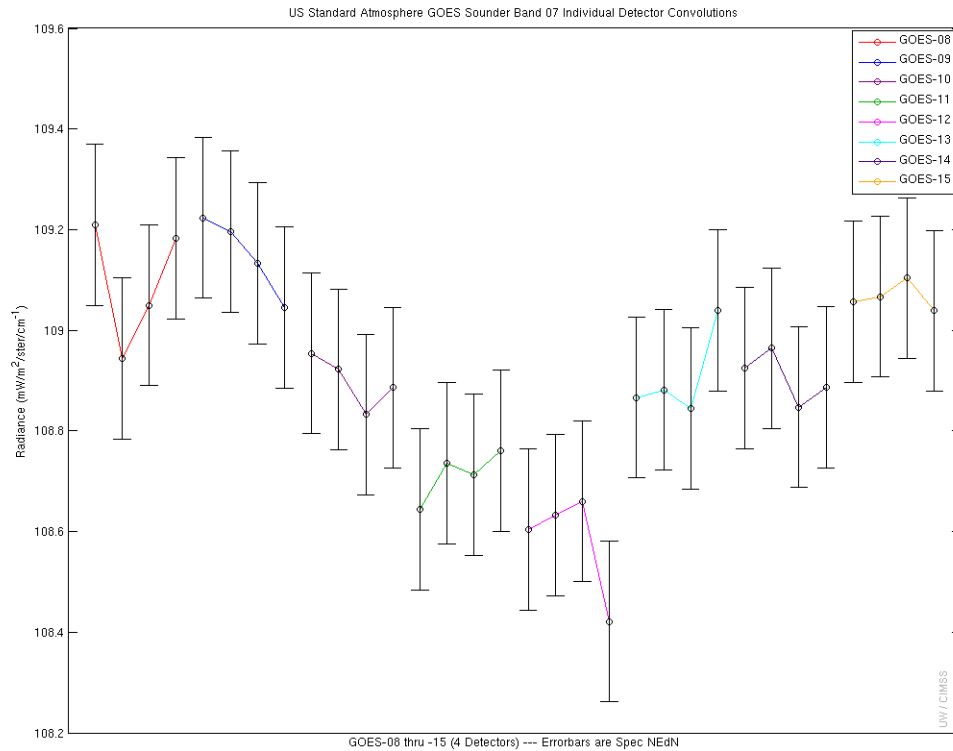
## Publications and Conference Reports

Gunshor, Mathew M., S. Moeller, and T. J. Schmit, 2012: "Investigating The Effects of Detector-Averaged SRFs", a poster presented at the NOAA Satellite Science Week, Kansas City, MO, May 2012.

## References

Gunshor, Mathew M.; Tobin, D.; Schmit, T. J. and Menzel, W. P.. Intercalibration activities at CIMSS in preparation for the GOES-R era. Annual Symposium on Future National Operational Environmental Satellite Systems - NPOESS and GOES-R, 6th, Atlanta, GA, 17-21 January 2010. Proceedings. American Meteorological Society, Boston, MA, 2010, Manuscript not available for publication.

Schmit, Timothy J.; Gurka, J. and Gunshor, M. M.. The ABI and GOES-R. Annual Symposium on Future National Operational Environmental Satellite Systems - NPOESS and GOES-R, 6th, Atlanta, GA, 17-21 January 2010. Proceedings. American Meteorological Society, Boston, MA, 2010, Manuscript not available for publication.



**Figure 9.3.1.** GOES-08 through -15 individual detector brightness temperatures calculated for the US Standard Atmosphere spectrum convolved with the GOES SRFs for Sounder band 7 (~12 micrometers). The conversion from radiance to brightness temperature was calculated using detector-averaged (per satellite) SRFs, which introduces some error when the SRFs for the four detectors are not similar enough. The bars show +/- NEdT and the dots are the calculated brightness temperature for each detector. An example of an “out of family” detector is shown here as the fourth detector for GOES-12 where the dot is colder than the NEdT bars for the other three detectors.

Gunshor, M. M., T. J. Schmit, W. P. Menzel, and D. C. Tobin, 2009: Intercalibration of broadband geostationary imagers using AIRS. *J. Atmos. Oceanic Technol.*, **26**, 746-758.

Schmit, T. J., R. M. Rabin, A. S. Bachmeier, J. Li, M. M. Gunshor, H. Steigerwaldt, A. J. Schreiner, R. M. Aune, and G. S. Wade (2009): Many uses of the geostationary operational environmental satellite-10 sounder and imager during a high inclination state. *Journal of Applied Remote Sensing*, **3**, Doi:10.1117/1.2099709.

Schmit, Timothy J.; Gunshor, Mathew M.; Menzel, W. Paul; Gurka, James J.; Li, Jun, and Bachmeier, A. Scott. Introducing the next-generation Advanced Baseline Imager on GOES-R. *Bulletin of the American Meteorological Society*, **86**, no.8, 2005, pp1079-1096.





## 9.4. McIDAS-V Support for GOES-R Risk Reduction Projects

**CIMSS Task Leaders: Tom Achtor, Tom Rink**

**CIMSS Support Scientists: Ralph Peterson, Jun Li**

**NOAA Collaborator: Tim Schmit**

### **NOAA Long Term Goals**

- Weather-Ready Nation

### **NOAA Strategic Goals**

- Serve society's needs for weather and water
- Support the nation's commerce with information for safe, efficient and environmentally sound transportation
- Provide critical support for the NOAA mission

### **CIMSS Research Themes**

- Satellite Meteorology Research and Applications
- Environmental Models and Data Assimilation

### **Proposed Work**

We proposed to continue support for selected GOES-R Risk Reduction projects by developing the capability in McIDAS-V to visualize all data used in these projects and develop analysis tools to enable quantitative evaluation of the output products.

Previously the display of pre-computed atmospheric wind parcel trajectories has been demonstrated by using McIDAS-V in showing the utility, and evaluation, of the NearCast forward trajectory model. To extend this capability, we are developing a tri-linear algorithm for forward/reverse trajectory computation from a time series of Eulerian wind field points sampled on a 2D or 3D grid. One potential application relevant to GOES-R is the display of 3D trajectories through time, based on ABI retrieved Aerosol optical depth (AOD) and numerical model wind forecast. Another GOES-R application would be to visualize the forward trajectories of parcels in the vicinity of volcanic eruption with respect to ash/SO<sub>2</sub> retrievals. We will enhance our trajectory computation for smooth time interpolation and integrate into the core display library of McIDAS-V. We will develop interactive on-display screen tools so users can drop-in parcel start/stop positions for forward/reverse trajectories. Trajectory ribbons, showing rotation, can be added as well. If time permits, computational efficiency improvements can be investigated, for instance, GPU processing for faster multiple trajectory displays.

### **Summary of Accomplishments and Findings**

A McIDAS-V plugin (facility for specific system customizations) has been developed to generate 3D displays of atmospheric pressure contours rendered on isentropic surfaces. This plugin can be used to overlay other parameters on the terrain-like constant theta surface, such as equivalent potential temperature and wind. This provides the researcher a 3D view of isentropic surfaces in space, while advancing new capabilities for display of parameters computed in alternate vertical coordinate systems. (Figure 9.4.1) We plan to continue to this type of development to support the NearCast project.

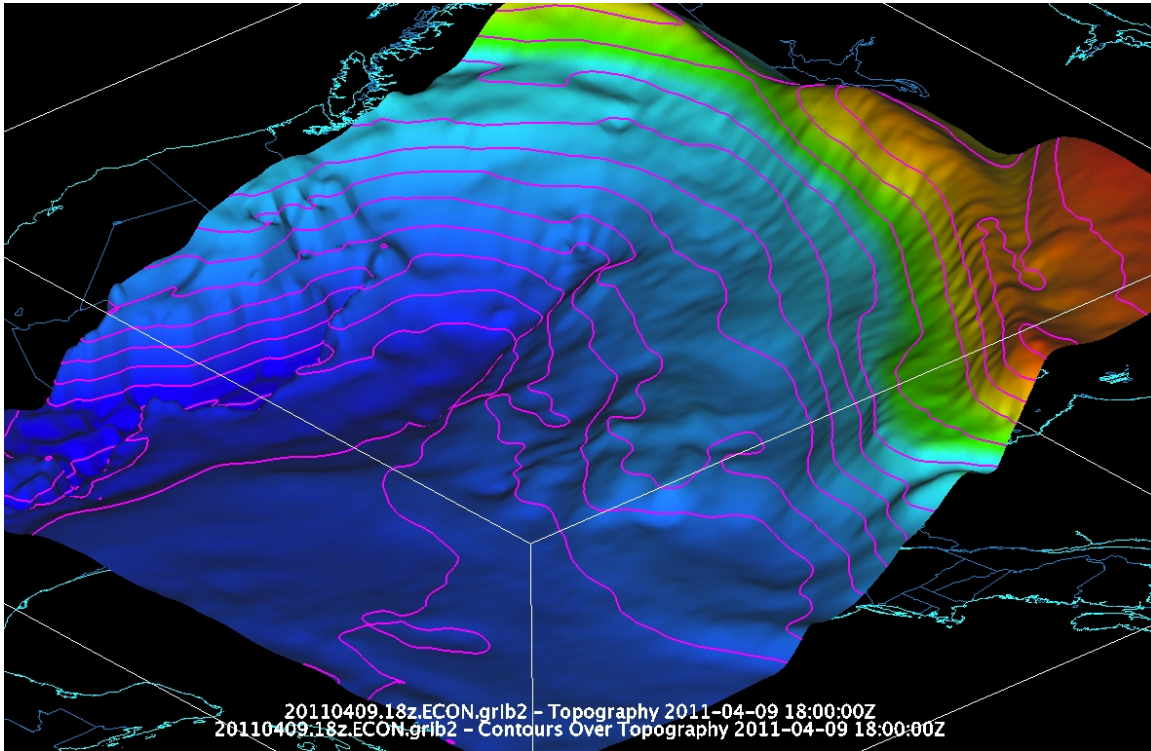


Figure 9.4.1. McIDAS-V 3-D display of pressure contours on a constant theta surface.

## 9.5. Improvements to QPE Using GOES Visible ABI and Model Data

**CIMSS Task Leader: Jason Otkin**

**NOAA Collaborators: Robert Rabin, Robert Kuligowski, and V. Lakshmanan**

**NOAA Long Term Goals**

- Weather-Ready Nation

**NOAA Strategic Goals**

- Serve society's needs for weather and water

**CIMSS Research Themes**

- Satellite Meteorology Research and Applications
- Satellite Sensors and Techniques

### Proposed Work

The proposed work addresses the need for remote sensing-based estimates of precipitation in portions of the U.S. and its coastal waters where WSR-88D radar is limited due to the radar beam being blocked and/or overshooting the precipitation. Heavy precipitation poses threats of flash flooding, but existing satellite techniques often perform poorly in pinpointing locations of heavy rain, especially when cloud tops are relatively warm.

Improvements to the existing Self-Calibrating Multivariate Precipitation Retrieval (SCaMPR) algorithm will be made using high resolution cloud structure from GOES visible imagery, estimates of cloud top phase and particle size derived from GOES, and moisture and wind fields from numerical weather prediction (NWP) model and NWP+satellite “blended” data. Preliminary work at the National Severe Storms Laboratory (NSSL) indicates that a simple technique used to

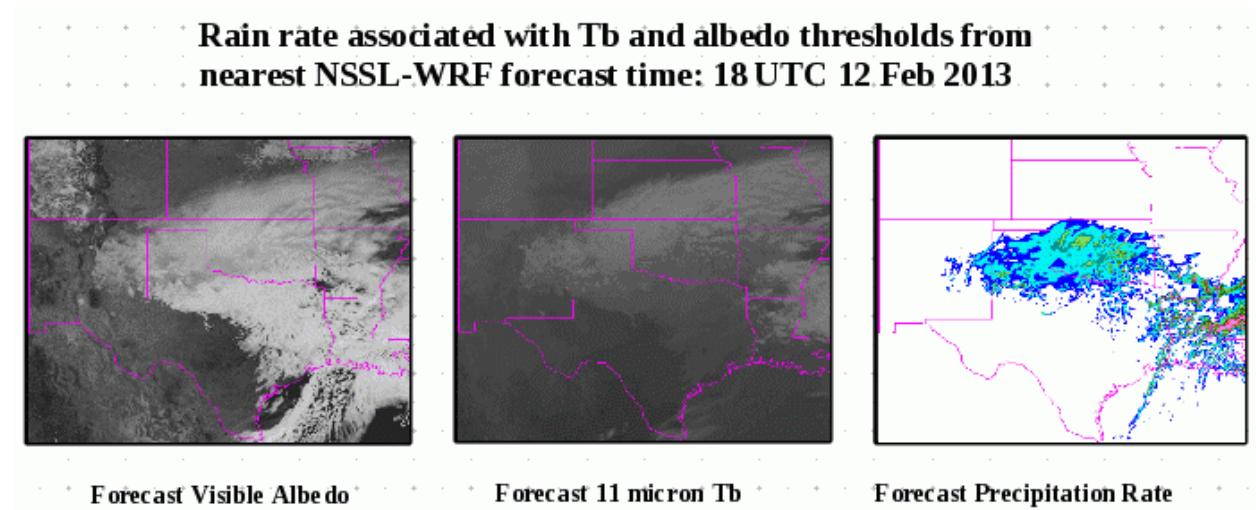


identify small-scale convective cloud tops in visible satellite imagery performs better than infrared-only techniques in matching radar echoes in many situations.

### Summary of Accomplishments and Findings

During the past year, synthetic ABI visible reflectances and infrared brightness temperatures computed each day using output from real-time NSSL-WRF model forecasts were provided to NSSL researchers to investigate relationships between the spatial structure of visible satellite imagery and the model cloud optical depth, cloud top height, and accumulated precipitation. Data support was provided for the real-time simulations and also for a very high-resolution (500 m) synthetic ABI dataset delivered last year that tracked the evolution of two mesoscale convective systems across the Upper Midwest during July 2006.

By using synthetic imagery, methods were devised to extract information on precipitation rate versus cloud albedo and brightness temperatures that were subsequently applied to observed satellite imagery. Fig. 9.5.1 shows a representative example of forecast precipitation rate estimated using simulated visible albedo and 11  $\mu\text{m}$  brightness temperatures from the NSSL-WRF model. A Web-based assessment tool was created to compare real-time GOES imagery with cloud top products and with both observed and estimated quantitative precipitation estimates (QPE). Ongoing work includes testing the use of cloud optical depth rather than albedo and incorporating the QPE product and individual cloud top parameters into SCaMPR.



**Figure 9.5.1.** Example forecast visible albedo (left panel), 11  $\mu\text{m}$  brightness temperatures (middle panel), and estimated precipitation rate (right panel), computed using data from the NSSL-WRF model forecast at 18 UTC on 12 Feb 2013.

### Publications and Conference Reports

Rabin, R., R. Kuligowski, J. A. Otkin, V. Lakshmanan, and L. Grasso, 2013: Improvements to QPE using GOES visible ABI and model data. *NOAA Satellite Science Week Virtual Meeting*.



## **9.6. Developing Assimilation Techniques for Atmospheric Motion Vectors Derived via a New Nested Tracking Algorithm Derived for the GOES-R Advanced Baseline Imager (ABI)**

**CIMSS Task Leader: James Jung**

**CIMSS Support Scientists: Sharon Nebuda, Dave Santek**

**NOAA Collaborator: Jamie Daniels**

### **NOAA Long Term Goals**

- Weather-Ready Nation

### **NOAA Strategic Goals**

- Serve society's needs for weather and water
- Support the nation's commerce with information for safe, efficient and environmentally sound transportation

### **CIMSS Research Themes**

- Satellite Meteorology Research and Applications
- Environmental Models and Data Assimilation

### **Proposed Work**

An Atmospheric Motion Vector (AMV) product has been developed for the Geostationary Operational Environmental Satellite series R (GOES-R) Advanced Baseline Imager (ABI) using a new tracking algorithm. The technique was developed by Bresky et al. (2012) of the GOES-R Algorithm Working Group (AWG). Proxy data has been created by applying the GOES-R algorithm to imagery from the Meteosat Spinning Enhanced Visible InfraRed Imager (SEVIRI). This proxy data provides the opportunity to determine software changes needed for the National Center for Environmental Prediction (NCEP) Global Forecast System (GFS) Gridpoint Statistical Interpolation (GSI) to successfully assimilate this data.

This project is designed to illustrate the future performance of the new GOES-R AMVs in the operational NCEP GFS. To achieve this end, a pre-implementation version of the GFS GSI software will be used. Quality control procedures will be reviewed by examining current quality control parameters as well as considering new parameters related to the nested tracking algorithm. Determining the appropriate observation error for this AMV product is also required. Once assimilation techniques have been selected and verified, software modifications to the GSI will be reviewed by NCEP Environmental Modeling Center (EMC). Analysis and forecast statistics will be collected for two months during two different seasons. The simulations which assimilate the GOES-R AMVs will be compared to a control simulation which does not assimilate AMVs in the SEVIRI region. With the computing support of the Joint Center for Satellite Data Assimilation, the seasonal simulations will be run using the Center's computer, JIBB.

### **Summary of Accomplishments and Findings**

Current Numerical Weather Prediction (NWP) AMV quality control procedures avoid parameters which rely on the departure from the forecast model background state. Traditional AMV quality control parameters of Quality Indicator (QI, Holmlund 1998) and Expected Error (EE, Le Marshall et al., 2004) have proven to be useful in predicting AMV quality. To maintain this preference, the modified QI parameter, which does not contain forecast information, was chosen to begin testing. Likewise, the use of EE was limited to screening slow winds with large error by testing against a threshold of the ratio of EE to the observation speed. Two nested tracking parameters related to cluster size and cluster correlation were also included in initial quality control tests. The smallest values of these parameters showed an increase in wind vector difference RMSE with respect to the background state. The statistics from the two short runs were



also examined for quality dependency on observation zenith angle, surface type, and cloud type. No concerns with data quality were found with these parameters.

Evaluation of the GOES-R AMVs assimilation statistics from two short GFS simulations during two different seasons was conducted. These results were examined to identify possible quality control procedures for the AMVs and provided an initial look at their performance in the GFS. The initial results did reveal a fast bias for the ABI Channel 8 Cloud Top Water Vapor (CTWV) AMVs which have since prompted an adjustment to the algorithm. The modified algorithm produces CTWV AMVs with increased height which subsequently reduces their bias compared to the background state as wind speed tends to increase with height in the troposphere. Results from these short GFS simulations have provided guidance for how to proceed with quality control settings for the longer seasonal simulations as well as identified a modification needed for the CTWV AMVs.

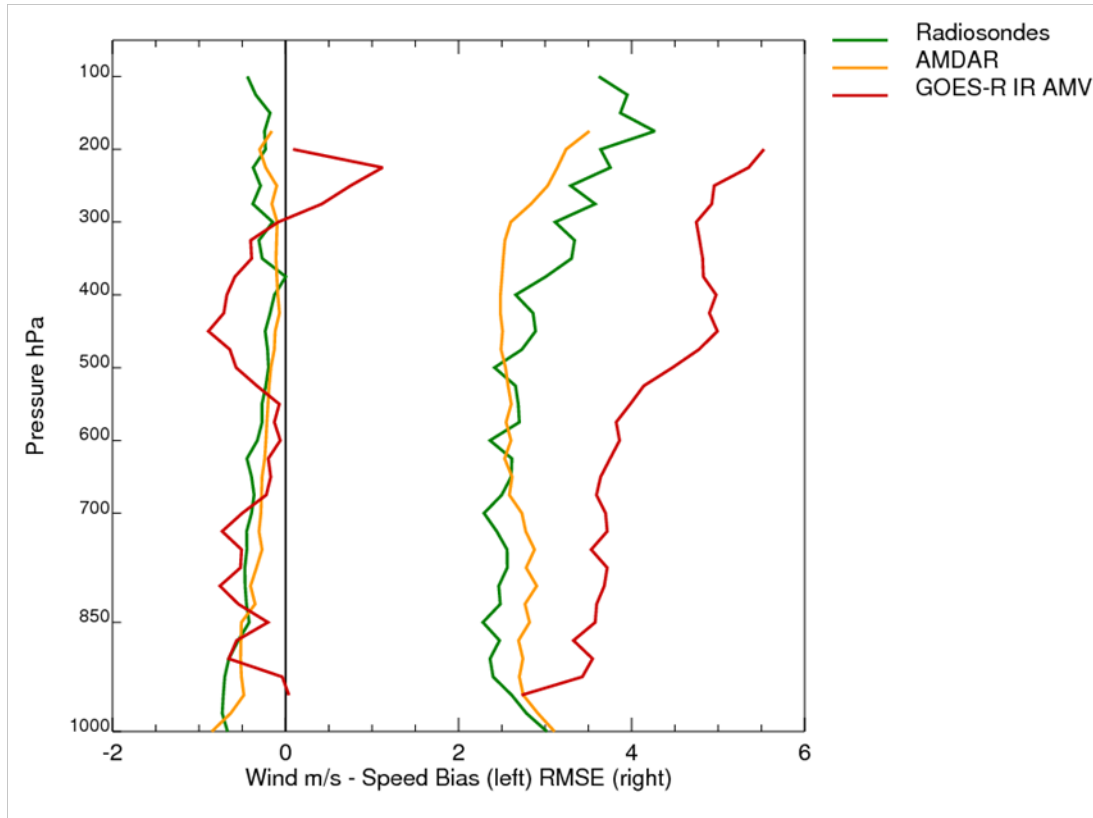
The first season results have revealed an observation minus analysis wind vector difference RMSE which is not ideal for the ABI Channel 14 infrared AMVs. Comparing with in situ data, radiosondes and wind information from the Aircraft Meteorological Data and Reporting (AMDAR) World Meteorological Organization (WMO) pilot reports illustrates the desired performance of the satellite winds to be on the order of 2.5 m/s RMSE instead of the 4.0 m/s shown in Figure 9.6.1. The large RMSE for the GOES-R AMVs indicates either the quality control is too lenient or the specified observation error is too large. Tuning experiments, which varied the observation error in the GSI, showed a positive response by the wind vector difference RMSE. Examining observation minus background state statistics from this first seasonal run demonstrated that the EE would provide stronger screening of AMVs due to its inclusion of a forecast component. Both observation error and quality control settings continue to be investigated to optimize the GOES-R AMV performance in the GFS. Once ideal settings are selected, the simulations which include the GOES-R AMVs will be completed.

The usefulness of assimilating the GOES-R proxy AMVs within the GFS has been confirmed with the results thus far. Feedback has been provided to the algorithm development team as well as determining that adjustments to current geostationary AMV quality control. Observation error may still need to be adjusted to successfully assimilate these new AMV data. Upon completion of the two seasonal simulations, the assessment of impact on the analysis statistics and forecast skill will be conducted. Software changes to the GSI will be reviewed for approval as well as testing the input of the GOES-R AMVs in the operational BUFR format.

### **Publications and Conference Reports**

Nebuda, S., J. Jung, D. Santek, J. Daniels, and W. Bresky 2013: GOES-R AWG Atmospheric Motion Vectors: First Look at Assimilation in NCEP GFS. *Special Symposium on the Joint Center for Satellite Data Assimilation*, 93rd Annual AMS Meeting, Austin TX, 6-10 January 2013.

Nebuda, S., J. Jung, D. Santek, J. Daniels, and W. Bresky 2013: GOES-R Atmospheric Motion Vectors: Assimilation in NCEP GFS. *NOAA Satellite Science Week Virtual Meeting*, 18-22 March 2013.



**Figure 9.6.1.** Vertical profiles of speed bias and wind vector difference RMSE for radiosondes, AMDAR winds and the GOES-R proxy AMVs with respect to the GFS analysis. Observations are within the region 35-45N and 5W-45E and for 16 May – 30 June, 2012.

### References

Bresky, W. C., J. M. Daniels, A. A. Bailey and S. T. Wanzong, 2012: New Methods toward Minimizing the Slow Speed Bias Associated with Atmospheric Motion Vectors. *J. Appl. Meteor. Climatol.*, **51**, 2137-2151.

Holmlund, K. 1998. The utilization of statistical properties of satellite-derived atmospheric motion vectors to derive quality indicators. *Wea. Forecasting*, **13**, 1093–1105.

Le Marshall, J., Rea, A., Leslie, L., Seecamp, R. and Dunn, M. 2004. Error Characterization of Atmospheric Motion Vectors. *Aust. Met. Mag.*, **53**, 123 – 131.

### 9.7. Improving GOES-R Temperature/Moisture Retrievals and Derived Products and NearCasts Using Hyper-spectral POES Soundings and Validating NearCast Products for GOES-R Proving Ground

**CIMSS Task Leader: Ralph A. Petersen**

**NOAA Collaborators: Robert Aune, Gary Wade, Tim Schmit**

**CIMSS Graduate Student: William Line**

**NOAA Long-Term Goals Supported**

- Weather-Ready Nation



## **NOAA Strategic Goals**

- Serve society's needs for weather and water
- Support the nation's commerce with information for safe, efficient and environmentally sound transportation
- Provide critical support for the NOAA mission

## **CIMSS Research Themes**

- Satellite Meteorology Research and Applications
- Environmental Models and Data Assimilation

## **Project Description**

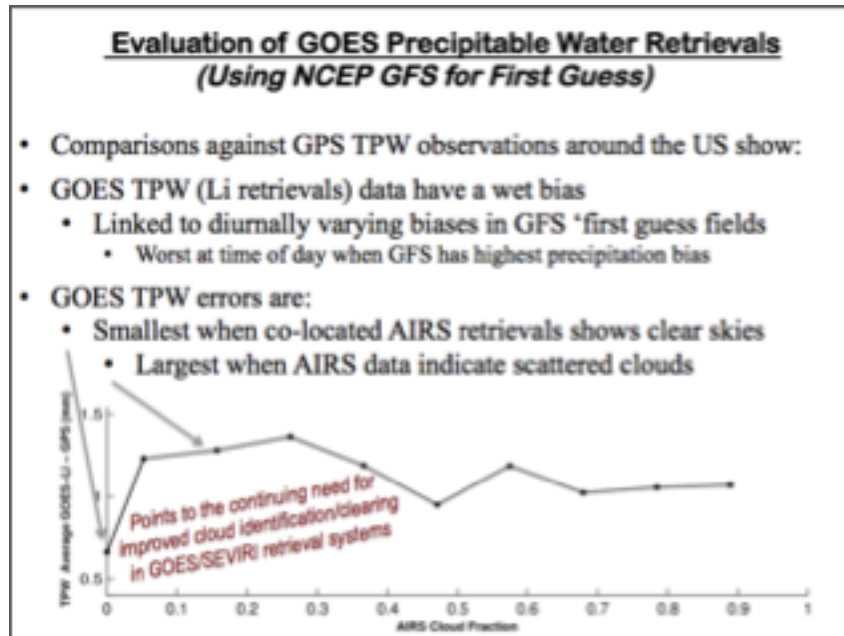
The overall objective of this effort is to provide data driven tools to help NWS forecasters expand their use of GOES moisture and temperature soundings by 1) enhancing and expanding existing observations using clear-air variables that GOES observes and 2) adding new products to forecast the near-future state of the pre-storm environment. (It should be remembered that no GOES clear-air sounder data are used in any operational NWP model over land.) The project has three primary tasks: 1) to determine how information contained in ancillary asynoptic datasets (including GPS-Total Precipitable Water (GPS/TPW), AMDAR aircraft profiles, Raman Lidar observations from the ARM CART site and hyperspectral POES retrievals) could be used to enhance GOES-R products by identifying and removing biases and also facilitating combination of GOES-R data with soundings from existing GOES satellites and then using these products in NearCasts covering the next 6-9 hours, 2) to incorporate these enhanced sounding products into multi-layer and isentropic versions of the NearCasting analyses and short-range forecasts, and 3) to perform assessments and validations of the NearCasting products using objective scores and at participating GOES-R Proving Ground sites.

## **Summary of accomplishments**

Revised milestones for the second year of this project are shown at the end of this section, along with notations about progress already made on the various tasks. The revisions were necessary due to budget reductions in year 2 and 3 of this effort. All milestones are on or ahead of schedule. Detail of the three major tasks follows.

### ***Task 1 – Improving quality of GOES Moisture Retrievals***

The initial developmental effort for the first task of this project was designed to meld information from POES and GOES retrievals as a means of improving upon the GOES products both at the time of the POES observations and into the near future. This investigation was one of the first to study the quality of AIRS retrievals over land. Unfortunately, comparisons of the operational AIRS Team Retrievals (as well as several other research retrieval methods) with GPS/TPW observations all showed larger biases and standard deviations than the operational GOES retrievals, as well as excessive day-to-day variations. As such, alternative approaches have been developed to calibrate the GOES retrievals using other surface-based systems including operational AMDAR WVSS-II aircraft observations, GPS /TPW and research-quality Raman Lidar profiles from the ARM CART site. Additional work using the combination of POES and GOES profiles was performed using data from AIRS retrievals that are classified as being “completely cloud free,” in which case the quality of the AIRS TPWE increases substantially. The largest errors in the GOES TPW retrievals occurs in situations of scattered clouds, pointing to the importance of improving future cloud-clearing techniques. (See Fig. 9.7.1)



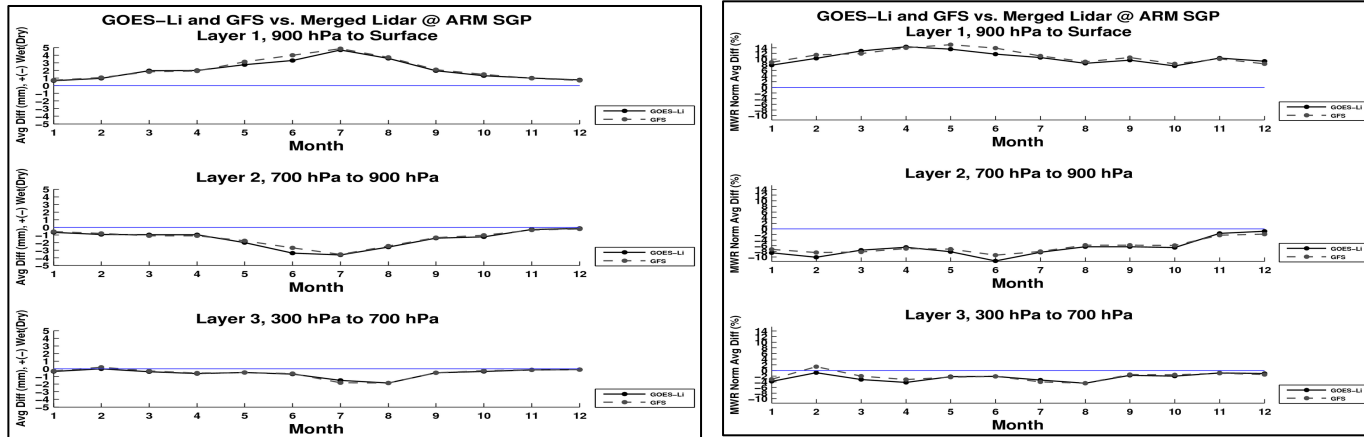
**Figure 9.7.1.** Amount of GOES TPW bias in “Li” retrievals as a function of cloudiness (as determined by co-located AIRS retrievals) for calendar year 2011.

The statistical inter-comparisons between the GOES retrievals and GPS/TPW data were also used by NESDIS operations in justifying for the conversion of the operational NESDIS GOES retrieval systems from the old “Ma” to the new “Li” system. The results verified that the “Li” retrievals not only have smaller systematic (biases) and random (standard deviations) error, but also have less cloud contamination.

Results using GOES-GPS/TPW data for all of 2011 showed distinctly that the biases in the GOES TPW products are largely the result of biases in the NWP first guess fields from the NCEP-GFS used during the retrieval reprocess. Not only do the GOES sounding products mirror biases in TPW from the short-range GFS forecasts, the biases in the 3-layer GOES PW products as determined by comparisons with Raman Lidar profiles also match the vertical variation in errors in the GFS in those layers. Finally, the errors in the GFS fields show strong systematic biases in moisture from one forecast cycle to the next. The GOES moisture data also showed that the greatest improvement in random errors over NWP products occurred during the warm months, a time of year when short-range NWP precipitation forecasts have their least skill.

A bias removal method for the multi-layer GOES moisture data has been developed based on normalized bias statistics. Although a strong seasonal signal is present in both the GFS and GOES TPW and the 3-layer PW products (Fig. 9.7.2 left), statistics for the relative error in the 3-layers of GOES PW presented in the right panel of Fig. 9.7.2 show only small month-to-month variability. Based on these findings, plans are in place to remove a constant relative bias correction from the GOES moisture products before the data are used in the NearCast analyses and forecasts. Different correction will be used for each of the 4 GFS cycles that are used as first guess field, as well as for GOES-East and GOES-West. This will also allow a unified NearCast product to be developed that covers the entire CONUS, a request from participants from the Western and Southern Regions both at the SPC and AWC Proving Grounds tests this past spring and the earlier NOAA Science Workshop in Kansas City.





**Figure 9.7.2.** Left: Monthly Biases in 3-layer moisture from GOES-East (solid) and GFS first-guess (dashed) for 2011. Right: Same as left, except biases normalized by amount of moisture observed in each layer.

### **Task 2 - Converting the NearCasting System from an Isobaric to an Isentropic Framework**

This effort was designed to enhance the importance of the satellite products in short-range forecasts and to provide forecasters a more complete picture of the total amount of moisture and energy being transported adiabatically into areas of interest and an improved understanding of near-term vertical motions.

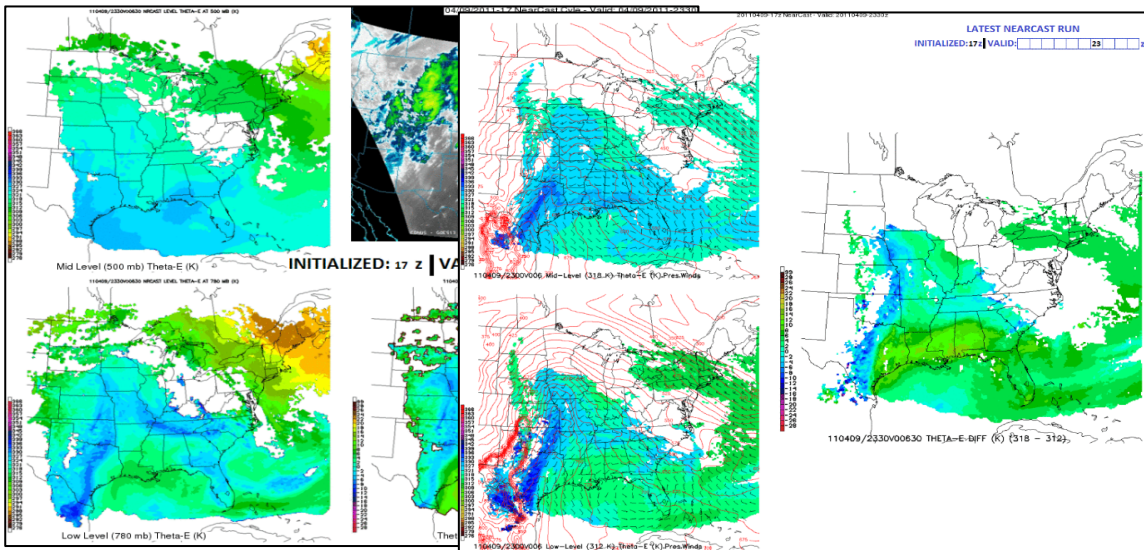
The reformulation of the diagnostic/predictive NearCasting model to a many-layer isentropic version has been completed and tested using a variety of case studies. Results are being compared with output from the conventional isobaric version. A case study example follows.

Results from the original isobaric and new isentropic versions of the NearCast model are shown in Fig. 9.7.2. The left panel shows a ‘conventional’ 5-hour NearCast of the pre-storm environment that developed in advance of a tornadic thunderstorm complex that formed around after 2300 UTC over far west-central IA (see satellite image in upper right panel). Note that by 0000UTC, the NearCasts had predicted the dry/cool air aloft (lower  $\theta_e$  values in upper left panel) to move over lower-level warm/moist air (higher  $\theta_e$  values in lower left panel), creating an area of increasing convective instability over far western IA (blue area in lower-right panel) at the time and location of the rapid storm development.

Results of the isentropic version of the NearCast analysis and forecast system are shown in the right half of Fig. 9.7.3. Although the isentropic NearCasts show a similar area of destabilization moving into far western IA, the depictions of the lower-level moisture supply moving northward from the Gulf and upper-level dryness overlaying it from the southwest are more distinct and well defined. The isentropic output also adds information showing that the lower-level parcels that have been moving relatively horizontally from their source in the Gulf are suddenly lifted as they reach western IA where the convective destabilization is occurring. Additional diagnostic parameters, including vertical motion, total adiabatic moisture transport and moisture flux convergence displays are also under development. To ease forecaster interpretation of the isentropic outputs, post-processing will be added to interpolate the isentropic fields back to both isobaric and a surface-following coordinate for display.



One of the major advances from this reporting period is that the use of isentropic depictions of flow in the free atmosphere allows areas that are prone for rapid development of severe convection to be separated from those that are being primed for heavy precipitation. Specifically, severe convection was found to areas where the leading edges of descending upper-level dry air overtakes areas of ascending lower-level moist, warm air, leading to large vertical gradients of Equivalent Potential Temperature. By contrast, areas of heavy convective precipitation were found ahead of regions where the total moisture transport in lower-level isentropic layers [defined as the covariance between the mass (inverse static stability) and average mixing ratio in the layer] was maximized, even though the vertical gradients of Equivalent Potential Temperature and lifting may have been smaller there.



**Figure 9.7.3.** Left Half – Counter-clockwise from upper right - Validating satellite image for 2330 UTC 9 April 2012, 4.5 hour Conventional Isobaric NearCast prediction of Mid-level  $\theta_e$  from 1700 UTC valid at 2330 UTC, Lower-level  $\theta_e$  NearCast valid at 2330 UTC, and derived Convective Instability (vertical  $\theta_e$  difference between isobaric surfaces) valid at 2330 UTC. Right Half - Counter-clockwise from upper right – 4.5 hour Isentropic NearCast prediction of Mid-level (318K)  $\theta_e$  from 1700 UTC valid at 2330 UTC, Isentropic Lower-level (312K)  $\theta_e$  NearCast valid at 2330 UTC, and derived Convective Instability (vertical  $\theta_e$  difference between isentropic surface.) valid at 2330 UTC. Pressure topography of isentropic surfaces and wind NearCasts included as contours and barbs in left panels.

Details of this work were summarized in the poster by William Line, the graduate student working on the project, at the Annual National Weather Association meeting in Madison, WI in October 2012, which won the “Best Poster” competition at the meeting.

### **Task 3 - Validation and Testing**

Many of the recommendations provided by forecaster feedback at the past two GOES-Proving Grounds (PG) experiments have already been included in a variety of revisions/enhancements to the NearCasting system. Plans are underway to participate again in PG activities are SPC and AWC and to begin new interactions with PGs at HPC and OPC. More detail will be presented in the next reporting period.



Design of the proposed objective validation tools are ongoing but cannot be implemented until after the biases correction procedures described above have been implemented (since the variations in bias observed throughout the day affect not only the forecasts but also have different effects on the verifying analyses). Objective scores will include both comparison of the hourly-updated NearCast predictions against NearCast analyses and bias-corrected GOES observations, as well as point comparisons against vertical profiles from the ARM/CART Raman Lidar and AMDAR reports that include WVSS-II observations. This effort may become the focus of Gary Wade's MS thesis.

### ***Additional Related Efforts***

From the beginning of this project, efforts have been made to assure that the techniques can be tested using SEVIRI data as a surrogate for GOES-R prior to launch. Consistent with that goal, the NearCasting system is scheduled to be tested at the European Severe Storms Laboratory in the summer of 2013 using SEVIRI sounding data generated at CIMSS with the same software and first-guess fields that will be used when GOES-R becomes operational. The model and analysis system have been made fully relocatable and 24/7 testing has been underway since December. It has also been modified to accept 15-minute retrieval updates as a means of quantifying the impact of the higher-time-resolution data what will be provided by the GOES-R ABI instrument. This work is being done in full coordination with EUMETSAT and will reduce risk in using the GOES-R sounding products on day 1.

Also, at the request of NESDIS, WMO-CGMS and WMO-RA1 (via EUMETSAT), the NearCasting system has also been adapted for the area of equatorial east Africa with the objective of improving forecasts of convection over Lake Victoria. This convection can present a substantial hazard to the fishing industry there. Initial tests of data provided by EUMETSAT has shown the ability to anticipate moisture flowing across the lake (and convective destabilization) into the areas and at the times when strong nocturnal land-breezes can provide lifting to trigger convection. Tests use real-time CIMSS generated SEVIRI sounding are being prepared. A proposal to support this effort has been submitted to NSF through NCAR.

### ***Additional Information***

1. Interaction with operational partners – Planning for training /valuation at SPC forecast desks being coordinated with SPC for spring 2013, participation at AWC PG activities being planned for summer 2013, interacted with HPC/OPC on requests for PG activities late in 2013/2014, training of MKX SOO and forecast staff on isentropic version of NearCasting system is planned for spring 2013.
2. Inter-comparisons of GOES moisture retrievals with GPS TPW and Raman Lidar profiles were used to justify implementation of LI retrieval systems into NESDIS operations.

### **Publications and Conference Reports**

Poster Presentation by Petersen et al. at NOAA Science Week in Kansas City, MO (April 2012)

Presentation by Petersen et al. at EUMETSAT Users Conference (Sept. 2012)

Presentation and Poster by Petersen et al. and Line et al. at NWA Conference (Oct. 2012 ) Note: Graduate Student, William Line, received conference "Best Poster" award

Presentation by Petersen et al. at NWS Eastern Region Virtual Satellite Workshop (Feb. 2013)

Presentation by Line et al. at CIMMS, Norman, OK (March 2013)



## **Appendix - Revised Timelines**

Due to budget cuts, the second graduate student who was to be trained under this project in years 2&3 was eliminated and replaced by a part-time CIMSS research scientist who is reducing his participation in the project as the funding profile is reduced. Milestones were revised as follows:

- Q1: Participate in and provide training to SPC and AWC Proving Grounds activities (*Completed*) - Based on results of results of GOES/AIRS/GOES-Guess/GPS TPW inter-comparisons made during the first year of effort, begin tests of methods to remove biases (both in total PW and its vertical distribution) in GOES moisture products/analyses using GPS TPW data and project them forward in time and space using Lagrangian approaches (*Inter-comparison Completed*) – *Methodology Chosen – Implementation underway*) - Continue testing of Isentropic version of NearCasting system (*Ongoing – 24/7 tests underway*) - Continue to investigate systematic differences between GOES sounder (as proxy for ABI) and ‘non- operational’ hyperspectral POES data in real datasets using existing CIMSS staff (instead of new Graduate Student as originally proposed) (*Completed – Publications being prepared*)
- Q2: Expand isobaric and isentropic versions of NearCast model to include more vertical retrieval levels (*Completed*) - Expand validation parameters and procedures, including thermodynamics and winds (*Delayed due to continued reduction in Year-3 funding – resources used to support documentation/publication and to provide supporting evidence in operational implementation of Li retrieval systems at NESDIS Operations*) - Begin testing of NearCast model using real-time SEVIRI data (as a GOES-R proxy) for testing in Europe and Africa (*Real-time versions running over Europe using SEVIRI retrievals generated at CIMSS*)
- Q3: Develop additional output parameters using increased vertical levels (*New parameters available from isentropic model, along with isobaric output from isentropic model*) - Participate in and provide training to HPC and OPC Proving Grounds as needed (*Arrangements for visits to HPC/OPC are being established – funding for visits provided by GOES-R Visiting Scientist Program including endorsement of HPC/OPC*) - Begin regular testing of optimal statistical methods to transfer information between GOES sounder (as proxy for ABI) and GPS TPW data in NearCast model (*Methodology Chosen – Implementation underway in original isobaric model, methodologies being defined for increased level and isentropic versions*) **END OF CURRENT REPORTING PERIOD**
- Q4: Participate in SPC and AWC Proving Grounds as needed (dates being determined) - Expand validation procedures to include SPC and AWC related forecast problems/parameters - Implement optimal statistical methods to transfer information between GOES sounder and GPS TPW into the NearCast model

\*Note: Changes to FY2012 Milestones based on 1) reduction in funding from \$200K to \$148K and 2) results from inter-comparisons GOES/AIRS/GOES-Guess/GPS TPW which show that the operational AIRS ‘team’ moisture retrievals *over land* have larger variations in Bias than Li GOES TPW retrievals and much larger random spatial variability (as measured by Stand Deviation) than GOES data when compared to the GPS (and limited Raman Lidar) standard. As such, the original hypothesis that the twice-daily AIRS data could be used to correct the hourly GOES data has been assigned a reduced priority and alternative bias correction procedures using GPS TWP are being investigated. Other ‘non-operational’ AIRS retrievals are also being investigated for possible application. Also note that \$3.5K in GOES-R Visiting Scientist funds was approved to facilitate testing at HPC/OPC/AWC.



## 9.8. Convective Storm Forecasting 1-6 Hours Prior to Initiation

**CIMSS Task Leaders: Chris Velden, Steve Wanzong**

**NOAA Collaborators: Dan Lindsey (RAMMB), Bob Rabin (NSSL)**

### **NOAA Long Term Goals**

- Weather-Ready Nation

### **NOAA Strategic Goals**

- Serve society's needs for weather and water
- Provide critical support for the NOAA mission

### **CIMSS Research Themes**

- Satellite Meteorology Research and Applications

### **Proposed Work**

One of the greatest difficulties in severe storm forecasting is deciding where and when storms will initially form. Current numerical models struggle with this problem and often have large errors in their 1-6-hour forecasts for convective initiation (CI). The Advanced Baseline Imager (ABI) aboard GOES-R will provide an unprecedented array of spectral bands at improved spatial and temporal resolution relative to the current geostationary satellites, and offers great promise in improving skill in short-term CI forecasts. In a combined effort among several institutes listed above, we propose to examine this problem from several different but related fronts. The overall goal of this proposed task is to develop a single objective system that predicts where and when storms will form 1-6 hours prior to initiation. Collaboration will include analysis of chosen case study events over the U.S. (GOES/MODIS) and Europe (MSG SEVIRI), and a sharing of analysis strategies and datasets.

In thunderstorm forecasting, one of the largest difficulties continues to be convective initiation (CI), i.e., predicting where and when thunderstorms will form. After storms form and precipitation begins falling, radar is the primary tool used by forecasters to issue nowcasts, assess the storms' severity, and issue severe thunderstorm and tornado warnings. However, without precipitation-size particles, radar can only provide information on surface boundaries that sometimes help trigger convection. This information is generally used subjectively by forecasters, in combination with surface observations, numerical model output, and satellite imagery, to decide where and when new storms will form.

Up to this point, the majority of satellite-based CI research has focused on nowcasting which growing cumulus or towering cumulus clouds will develop into precipitating thunderstorms during the next 30-60 minutes. Despite the importance of this forecast problem, very little research has focused on determining what short-term predictive (e.g., during the next 1-6 hours) information is available from satellite data *prior to* cumulus cloud formation, or whether there is information within an initial field of shallow cumulus clouds about whether (and which) of these clouds will eventually become storms, or what regions are more likely to generate new deep convection.

GOES-R will provide us with a wealth of new infrared information, and when combined with improved radiometrics and much greater spatial and temporal resolution, there is potential to greatly improve the forecasting of CI. The ultimate goal of this work is to develop an automated, objective system to predict where and when storms will form between 1 and 6 hours prior to their initiation. Given this lofty goal, this proposed task is designed to begin the research necessary to develop such a predictive system.



Included in addressing this task are five separate institutes/groups, each initially attacking the problem on different applied research fronts. As a team, we will first focus on select CI events in a unified way, for data sharing and algorithm development. Then once the predictors are developed, we will conduct a real-time demonstration to evaluate, refine and optimize the scheme. The summary of tasks accomplished described below will reflect only those performed by CIMSS.

### Summary of Accomplishments and Findings

In year 2 of this effort, hourly model output from the 4-km NSSL WRF was archived during the summer (May-August) of 2012, and we have spent the last few months processing and analyzing it. Since real GOES-R data will not be available until after launch, NSSL WRF output is used to simulate GOES-R ABI data. The advantage of this approach is 1) we have radiances that match the ABI spectral bands, and 2) we have the remaining model output and therefore know exactly where and when storms form (for example), along with the details of the near-storm environment.

The CIMSS team computed mesoscale Atmospheric Motion Vectors (AMVs) over a selected domain using simulated NSSL WRF fields as a proxy during the severe weather season of 2012, and considered what diagnostics from this output could be used as a CI predictor. Given the improved temporal and spatial resolution with GOES-R, cloud tracking using AMVs should allow for the identification of mesoscale features, such as low-level regions of convergence. In the simulated ABI synthetic image data from the NSSL WRF, when a sufficient number of trackable clouds exist, it is shown that the AMVs can be used to improve a model first guess of low-level convergence (see Figure 9.8.1 below). However, there are frequently situations in which either no clouds or non-trackable clouds exist in the regions where CI occurs.

AMVs are derived from WRF model 4km simulated IR and VIS images at 5-min. intervals (proxy for GOES-R capability), and combined with clear-sky radar winds to modify a model analysis of low-level convergence prior to a convective event in OK/KS on 21 May (2011).

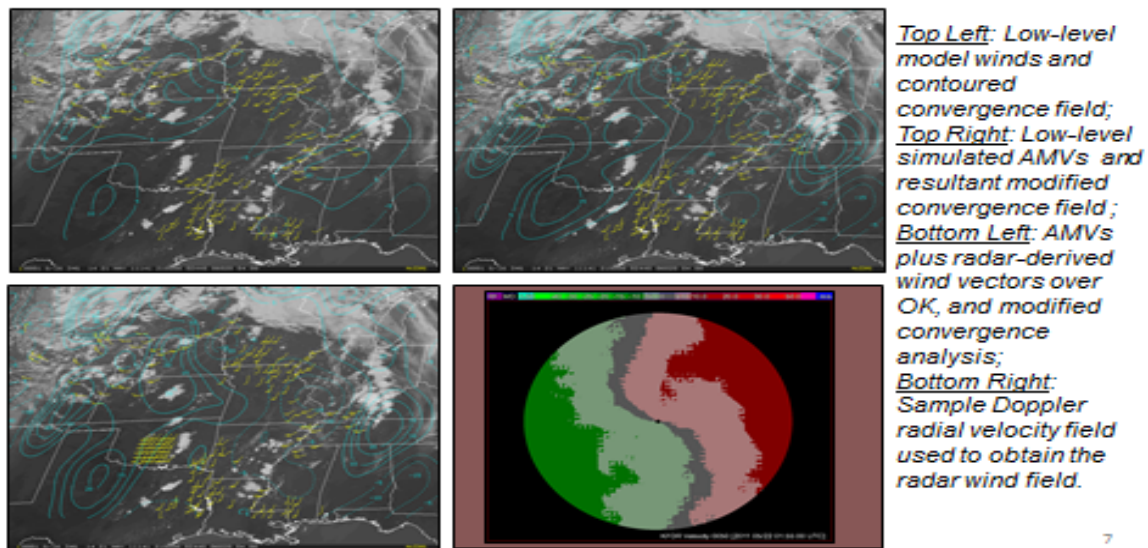


Figure 9.8.1. Simulated Atmospheric Motion Vectors (AMVs) and radar winds.

### Publications and Conference Reports

R. Rabin, D. T. Lindsey, L. Grasso, Mecikalski, J., C. S. Velden, B. L. Vant-Hull, and S. Wanzong, 2013: GOES-R Tools to Improve Convective Storm Forecasting 1-6 Hours Prior to Initiation. 2013 NOAA Satellite Science Week Symposium, College Park, MD.



## **9.9. Ensemble Simulation of GOES-R Proxy Radiance Data from CONUS Storm-Scale Ensemble Forecasts, Product Demonstration and Assessment at the Hazardous Weather Testbed GOES-R Proving Ground**

**CIMSS Task Leader: Jason Otkin**

**CIMSS Support Scientists: Rebecca Cintineo and Lee Counce**

**NOAA Collaborators: Steve Weiss, Fuzhong Weng, Jack Kain, and Dave Turner**

### **NOAA Long Term Goals**

- Weather-Ready Nation

### **NOAA Strategic Goals**

- Serve society's needs for weather and water

### **CIMSS Research Themes**

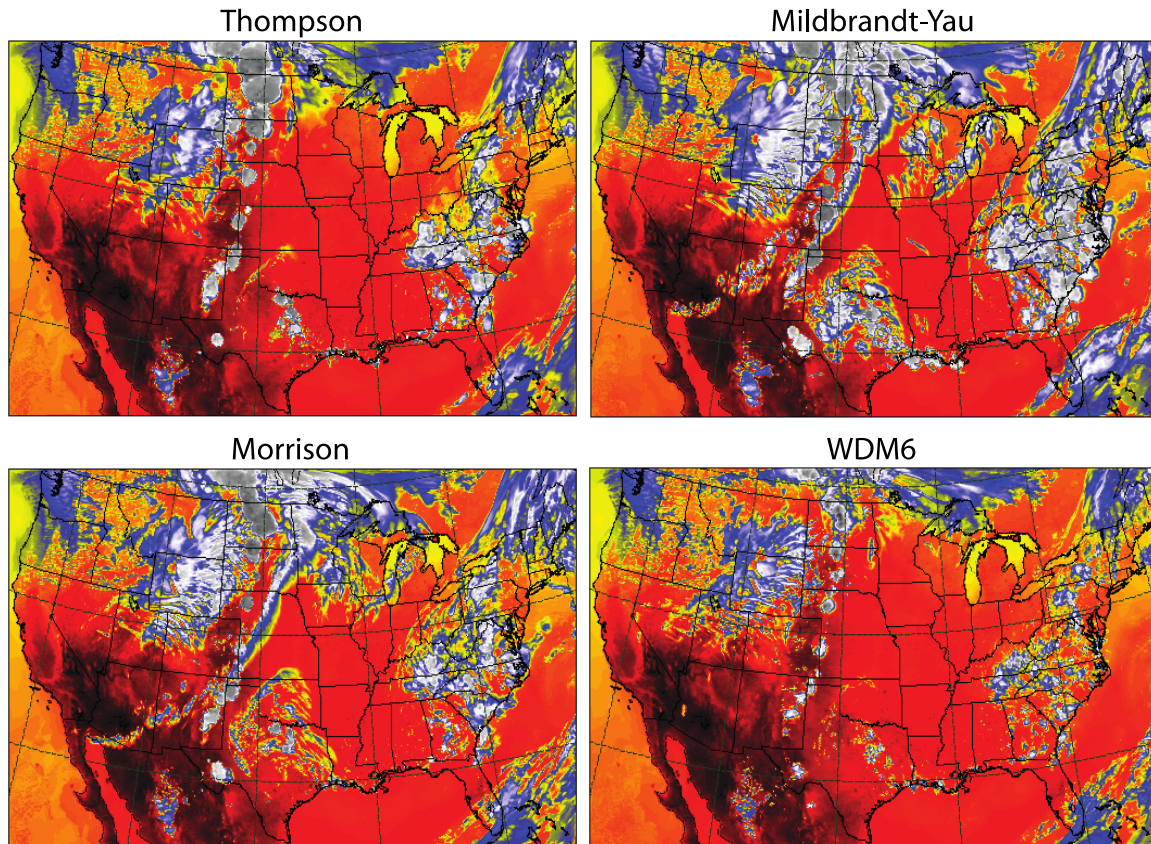
- Satellite Meteorology Research and Applications
- Environmental Models and Data Assimilation

### **Proposed Work**

As part of the NOAA Hazardous Weather Testbed (HWT) Spring Experiment (Clark et al., 2012), the Center for the Analysis and Prediction of Storms (CAPS) has produced high-resolution ensemble model forecasts in real-time over the CONUS since 2007. By utilizing national supercomputing resources, sophisticated forward radiative transfer models will be used to generate synthetic infrared brightness temperatures at hourly intervals for several CAPS ensemble members during the 2012 and 2013 HWT Spring Experiments. Since the ensemble forecasts employ different cloud microphysical and planetary boundary layer (PBL) parameterization schemes, an evaluation of the radiative transfer models, parameterization schemes, and forecast model performance will be possible at a convection-allowing resolution (4 km). The synthetic imagery will be made available in near realtime to the HWT as part of the GOES-R Proving Ground. The project will help familiarize operational forecasters, numerical modelers and physical scientists with the capabilities of GOES-R.

### **Summary of Accomplishments and Findings**

During the past 12 months, a processing system used to generate synthetic GOES-R, GOES-13, and GOES-15 infrared brightness temperatures was developed on the 'kraken' supercomputer at the National Institute for Computational Sciences (NICS) at the University of Tennessee. Model output from 20 CAPS ensemble members was used to generate synthetic satellite data each day during the 2012 HWT Spring Experiment. Participants at the HWT could view synthetic GOES-13 10.7  $\mu\text{m}$  imagery for a subset of the CAPS ensemble members via the CAPS ensemble model Web page ([http://www.caps.ou.edu/%7Efkong/sub\\_atm/spring12.html](http://www.caps.ou.edu/%7Efkong/sub_atm/spring12.html)). Feedback from the participants was generally positive. For instance, many people stated that the forecast imagery allowed them to efficiently examine the evolution of the forecast cloud field and to determine how much the model ensemble differed from reality at later forecast times. Figure 9.9.1 shows a representative example of synthetic GOES-13 10.7  $\mu\text{m}$  imagery from four of the CAPS ensemble members at 22 UTC on 22 May 2012. The ensemble members had identical configurations except for using different cloud parameterization schemes. Inspection of the synthetic imagery shows that the deep convection across the central U.S. was very sensitive to the assumptions made by each microphysics scheme. For instance, the Thompson scheme produced much more vigorous convection than the WDM6 scheme. Large differences are also apparent in the cirrus clouds, with the Milbrandt-Yau and Morrison schemes producing more extensive upper level cloudiness than the other schemes.



**Figure 9.9.1.** Simulated GOES-13 10.7 mm brightness temperatures (K) valid at 2200 UTC on 22 May 2012 for four of the CAPS ensemble members.

Ongoing work includes using the synthetic satellite observations to evaluate the performance of the microphysics and PBL parameterization schemes employed by the CAPS ensemble during the 2012 Hazardous Weather Testbed Spring Experiment through comparison with real satellite observations. The primary goal is to determine which schemes provide the most accurate cloud cover forecasts. Synthetic imagery is verified through comparison with real GOES-13 satellite observations.

Preliminary results indicate that the Milbrandt-Yau and Morrison microphysics schemes generate too many upper level clouds, while the WDM6 microphysics scheme consistently did not produce enough. When only low-level clouds are considered, the Milbrandt-Yau and Morrison schemes provide the best results. Though all of the microphysics schemes under-forecast the spatial extent of the low-level clouds, the Milbrandt-Yau and Morrison microphysics schemes tended to produce more clouds and thus were more realistic. Unlike the other schemes, the Thompson scheme did not have a consistent bias towards under- or over-producing cloud cover extent, and thus, appears to be most realistic.

The differences resulting from varying the PBL schemes are not as dramatic as those seen from varying the microphysics and the results are less consistent among the evaluation methods used, making it difficult to determine which scheme performs best for the springtime in the U.S., especially in situations with deep convection. In most cases, the ACM2, YSU, and MYNN PBL





schemes provide the best forecast of satellite imagery, while the MYJ and QNSE generally have lower skill, especially during the peak convective hours of the day.

A manuscript documenting results from this study is being prepared for publication.

### **Publications and Conference Reports**

Cintineo, R., J. A. Otkin, L. Counce, M. Xue, and F. Kong, 2013: Validation of WRF-ARW simulated brightness temperatures with GOES-13 satellite observations. In preparation for submission to *Mon. Wea. Rev.*

### **References**

Clark, A., and Coauthors, 2012: An overview of the 2010 Hazardous Weather Testbed Experimental Forecast Program Spring Experiment. *Bull. Am. Meteorol. Soc.*, **93**, 55-74.

Heidinger, A. K., C. O'Dell, R. Bennartz, and T. Greenwald, 2006: The successive-order-of-interaction radiative transfer model. Part I: Model development. *J. Appl. Meteor. Clim.*, **45**, 1388-1402.

## **9.10. Satellite Meteorology Resources and a GOES-R Education Proving Ground**

**CIMSS Task Leaders: Margaret Mooney and Steve Ackerman**

**NOAA Collaborators: Nina Jackson and Tim Schmit**

**NOAA Long Term Goals**

- Weather-Ready Nation

**NOAA Strategic Goals**

- Serve society's needs for weather and water

**CIMSS Research Themes**

- Satellite Meteorology Research and Applications
- Education and Outreach

### **Proposed Work**

The need for teacher training around the topic of satellite meteorology is stronger than ever as we approach the 2015 GOES-R launch. To address this need, CIMSS planned and conducted significant updates to the "Satellite Meteorology for Grades 7-12" CD and on-line resource which included incorporating user feedback to existing content and developing case studies based on recent large-scale environmental events. Upon completion of these revisions and additions, CIMSS has been promoting and distributing the revised resource at annual meetings of the American Meteorological Society (AMS), summer meetings of the Federation of Earth Science Information Partners (ESIP) and Satellite Educators Conferences.

CIMSS further proposed an "Education Proving Ground" featuring the design and development of activities for G7-12 teachers and students in preparation for the launch of GOES-R. Our eventual goal is to have scientists from CIMSS work with students virtually during post-launch GOES checkout activities. A key element of this effort will be sustained interaction between CIMSS EPO staff and a core group of committed educators recruited specifically to collect feedback for iterative improvements to the classroom activities prior to launch. The Education Proving Ground will rely on close coordination with CIMSS/ASPB scientists who check data quality following current GOES satellite launches. In this way, teachers will be ready to run



similar activities with their students following the 2015 GOES-R launch and be ready for the new types of satellite imagery and products which will be available in the upcoming GOES-R era.

The intended outcomes of this project are:

1. Awareness of NOAA's contributions to successive advances in remote sensing applications,
2. Increased utilization of satellite data in science classrooms,
3. Improvements in science literacy, and
4. An effective transfer of GOES-R satellite products to the educational community.

### **Summary of Accomplishments and Findings**

Content updates included the addition of the 2005 Hurricane Season, incorporating feedback acquired from past users, remote sensing aspects of the 2010 Deepwater Disaster, and a new module featuring the Suomi NPP Satellite, JPSS and GOES-R. These revisions to the *Satellite Meteorology for Grades 7-12* on-line course were completed in time for the 25th Satellite Educators Conference in August 2012 where the new module was presented by project partner Paul Ruscher and 100 CD's distributed to educators.

Paul Ruscher also recruited participants to the Education Proving Ground at the 2012 Satellite Educators conference. Meanwhile Margaret Mooney recruited participants from teachers attending the 2012 ESIP Teacher Workshop in Madison Wisconsin where the new SatCam App was also presented to teachers in attendance and a new technology lending library was launched where teachers were able to borrow a CIMSS iPad, like a book, for the entire school year.

A total of six middle or high school teachers will participate in the GOES-R Education Proving Ground over the 2013-2014 school year. The two from Wisconsin have already been selected. Final agreements are pending from other states. The goal is to have some or all of these teachers present their lesson plans at the 2014 Satellite Educators Conference, tentatively scheduled to take place in Madison at CIMSS.

### **Publications and Conference Reports**

GOES-R and the Next Generation Science Standards / Common Core: What's in it for Teachers?, 25<sup>th</sup> Satellite Educators Conference, August 9-11<sup>th</sup> 2012, California State University, Los Angeles CA.

Satellite Meteorology Resources, ESIP Teacher Workshop, July 17<sup>th</sup>-18, Madison WI.

### **References**

Mooney, Margaret; Ackerman, S.; Jackson, N.; Ruscher, P. and Rowley, P. Satellite meteorology resources and the GOES-R Education Proving Ground. Annual Symposium on Future Operational Environmental Satellite Systems, 9th, Austin, TX, 6-10 January 2013.

Mooney, Margaret; Ackerman, S.; Jackson, N. L. and Whittaker, T. Infusing satellite data into earth science education with SAGE, ESIP and SNAPP. Symposium on Education, 20th, Seattle, WA, 23-27 January 2011. American Meteorological Society (AMS), Boston, MA, 2011.

Margaret Mooney, and S. A. Ackerman, 2006: Satellite meteorology resources for K-16 educators and students, 15th Symposium on Education, Atlanta, GA, Jan 30-Feb 2.



**Figure 9.10.1.** GOES-R content in Satellite Meteorology for Grades 7-12 (<http://cimss.ssec.wisc.edu/satmet/>).

Mooney, M., S. A. Ackerman, T. H. Achtor, and J. Brunner, 2005: Satellite meteorology for middle and high school students and teachers. 14th Symposium on Education at 85th AMS Annual Meeting San Diego, CA, 10 Jan – 13 Jan.

Mooney, M., Ackerman, S. A., Achtor, T. H., and Brunner, J., 2004: Development of satellite meteorology teaching materials for grades 7-12. Symposium on Education, 13th, Seattle, WA, 11-15 January 2004 (preprints). American Meteorological Society, Boston, MA, 2004, pp. Paper 1.10.

### 9.11. Improved Understanding and Diagnosis of Tropical Cyclone Structure and Structure Changes

**CIMSS Task Leader: Christopher M. Rozoff**

**NOAA Collaborator: James P. Kossin (NCDC/CIMSS)**

**NOAA Long Term Goals**

- Weather-Ready Nation
- Resilient Coastal Communities and Economies



## **NOAA Strategic Goals**

- Serve society's needs for weather and water
- Support the nation's commerce with information for safe, efficient and environmentally sound transportation
- Provide critical support for the NOAA mission

## **CIMSS Research Themes**

- Satellite Meteorology Research and Applications
- Satellite Sensors and Techniques
- Environmental Models and Data Assimilation

## **Proposed Work**

Improving tropical cyclone (TC) intensity forecasts is one of the most important goals of TC research. However, the diagnosis and prediction of a TC's wind field structure is an operational requirement that is often considered equally important to intensity change in determining the impacts of landfalling TCs, initializing numerical weather prediction models, emergency preparedness and disaster mitigation. The products of GOES-R offer significant potential in the diagnosis of important TC features related to structural evolution.

To enhance GOES-R TC structure algorithms, we are carrying out a multi-institutional project consisting of NOAA, CIRA and UW-Madison/CIMSS collaborators to develop a variety of tools that will improve the diagnosis and forecasting of TC structure change. The NOAA/CIRA Project Leads will continue to carry out tasks incorporating GOES-R advanced baseline imagery (ABI) and GOES lightning mapper (GLM) proxy datasets, including developing algorithms to improve estimates of TC location, determine TC size and radius of maximum winds, and better understand the role of total precipitable water on TC size. The CIMSS project has used proxy ABI data to improve the diagnosis of TC structural changes and has also used passive microwave imagery (MI) to augment the proxy ABI datasets. The project groups are also working together on developing statistical-dynamical models incorporating some of the new structure-related ABI and GLM forecast products developing here.

## **Summary of Accomplishments and Findings**

A high-resolution simulation of a TC was run with the Weather and Research Forecast (WRF) model to study the impacts of the latent heating distribution on TC vortex structure. Analysis of this dataset confirms diabatic heating associated with rainband activity converges angular momentum outside of the TC inner-core and leads to the growth and strengthening of the wind field. Rainband latent heating becomes increasingly efficient at increasing the outer wind field as the TC size grows and even contributes to the development of an outer eyewall (Rozoff et al., 2012). Synthetic ABI proxy datasets were derived from WRF as well. These data show the coverage of thick ice clouds at the top of the troposphere relate fairly well with TC size and subsequent growth.

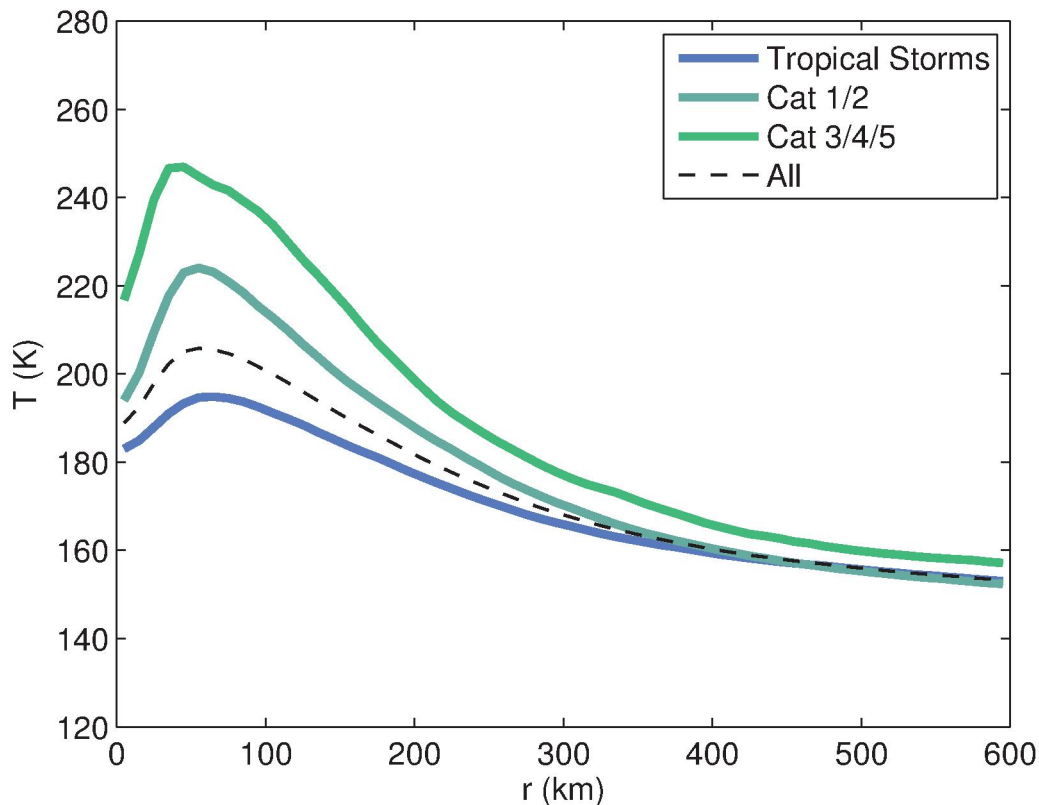
A variety of observational datasets have been used to examine aspects of size and size change as well. These observational datasets include ABI proxy datasets, GOES-IR imagery, and microwave imagery (MI).

Multi-layered cloud products (e.g., Pavolonis and Heidinger 2004; Naud et al., 2007) were derived from MSG-SEVIRI imagery for Atlantic Hurricane Julia (2010), a classic Cape Verde hurricane that experienced rapid intensification, an eyewall replacement cycle, and reached a maximum intensity of 120 kt. This case study showed that thick ice clouds at radii outside of 300-km seemed to relate better to storm size growth than the typical 0-300-km range GOES-IR



predictors found in retrospective datasets such as the SHIPS developmental dataset (DeMaria et al., 2005).

Given the observational and model-based proxy ABI data results, empirical models for TC size are being developed. As an example, a skillful logistic regression model was built to predict the probability of whether a TC's 34-kt wind radius ( $r_{34}$ ) will expand outward in the next 6 h (Atlantic only). This model utilizes the SHIPS developmental dataset derived from the operational GFS analyses, new structural predictors from the hurricane satellite (HURSAT) dataset, and the extended best track estimates of wind radii. It was found that many of the factors favorable for intensification are also conducive to storm growth. However, it is noteworthy that the strength of the outer wind and field and the amount of convective activity in the 300-600-km radial region are strongly related. CIMSS is now helping CIRA in the design of a statistical-dynamical size change model incorporating aspects of the climatology and persistence model detailed in Knaff et al. (2007) and the Statistical Hurricane Intensity Prediction Scheme (DeMaria et al., 2009).



**Figure 9.11.1.** Composites of azimuthal-average horizontal polarized 19-GHz TRMM-TMI brightness temperatures stratified by Saffir-Simpson-scale categories of intensity for Atlantic TCs between 1998-2011. Here, 928 individual brightness temperature profiles were utilized in this composite analysis.

Finally, a retrospective analysis of TC size change in the Atlantic and East Pacific Ocean basins using MI from multiple low-earth orbiting satellites is currently being carried out. As an example, Fig. 9.11.1 shows the composite radial structure of 19-GHz TRMM-TMI brightness temperatures for Atlantic TCs from 1998-2011. MI is being combined with other data sources to get a better understanding of how the precipitation distribution relates to TC structures and its environment.



The MI will also be combined with aircraft-analysis being conducted at CIRA in order to empirically determine the wind structure from MI.

### **Publications and Conference Reports**

DeMaria, M., J. Knaff, F. Weng, C. Velden, J. Li, C. Rozoff, G. Chirokova, R. DeMaria, J. Beven, and M. Brennan, 2013: NOAA Satellite Science Week Tropical Storms/Hurricanes Science Achievements. 2013 NOAA Satellite Week Conference, Mar. 18-22, 2013.

Rozoff, C. M., D. S. Nolan, J. P. Kossin, F. Zhang, and J. Fang, 2012: The roles of the expanding wind field and inertial stability in tropical cyclone secondary eyewall formation. *J. Atmos. Sci.*, **69**, 2621-2643.

Sitkowski, M., J. Kossin, C. M. Rozoff, and J. Knaff, 2012: Hurricane eyewall replacement cycles and the relict inner eyewall circulation. *Mon. Wea. Rev.*, **140**, 4035-4045.

### **References**

DeMaria, M., M. Mainelli, L. K. Shay, J. A. Knaff, and J. Kaplan, 2005: Further improvements to the Statistical Hurricane Prediction Scheme (SHIPS). *Wea. Forecasting*, **20**, 531-543.

DeMaria, M., 2009: A Simplified Dynamical System for Tropical Cyclone Intensity Prediction. *Mon. Wea. Rev.*, **137**, 68-82.

Knaff, J. A., C. R. Sampson, M. DeMaria, T. P. Marchok, J. M. Gross, C. J. McAdie, 2007: Statistical Tropical Cyclone Wind Radii Prediction Using Climatology and Persistence. *Wea. Forecasting*, **22**, 781-791.

Naud, C. M., B. Baum, M. Pavolonis, A. Heidinger, R. Frey, and H. Zhang, 2007: Comparison of MISR and MODIS cloud-top heights in the presence of cloud overlap. *Remote Sens. Environ.*, **107**, 200-210.

Pavolonis, M. J., and A. K. Heidinger, 2004: Daytime cloud overlap detection from AVHRR and VIIRS. *J. Appl. Meteor.*, **43**, 762-778.

## **9.12. Continued Development of the GOES-R AWG Fog/Low Cloud Products**

**CIMSS Task Leader: Corey Calvert**

**CIMSS Support Scientists: Chad Gravelle and Scott Lindstrom**

**NOAA Collaborator: Michael Pavolonis**

**NOAA Long Term Goals**

- Weather-Ready Nation

**NOAA Strategic Goals**

- Serve society's needs for weather and water
- Support the nation's commerce with information for safe, efficient and environmentally sound transportation

**CIMSS Research Themes**

- Satellite Meteorology Research and Applications

### **Proposed Work**

Low ceiling and visibility is a weather hazard that nearly every forecaster, in nearly every National Weather Service (NWS) Weather Forecast Office (WFO), must regularly address. In



addition, national forecast centers such as the Aviation Weather Center (AWC) Alaska Aviation Weather Unit (AAWU), and the Ocean Prediction Center (OPC) are responsible for issuing low ceiling and visibility related products. As such, reliable methods for detecting and characterizing hazardous low clouds are needed. Traditionally, hazardous areas of Fog/Low Stratus (FLS) are identified using a simple stand-alone satellite product that is constructed by subtracting the 3.9 and 11  $\mu\text{m}$  brightness temperatures. However, the 3.9-11  $\mu\text{m}$  brightness temperature difference (BTD) has several major limitations. In an effort to address the limitations of the 3.9-11  $\mu\text{m}$  BTD, the GOES-R Algorithm Working Group (AWG) developed an approach that fuses satellite, Numerical Weather Prediction (NWP) model, Sea Surface Temperature (SST) analyses, and other datasets (e.g., digital surface elevation maps, surface emissivity maps, and surface type maps) using a naïve Bayes classifier to determine the probability that Marginal Visual Flight Rules (MVFR), Instrument Flight Rules (IFR), and Low Instrument Flight Rules (LIFR) conditions are present at the resolution of the satellite data. MVFR/IFR/LIFR conditions are characterized by a cloud ceiling below 3000/1000/500 ft and/or a surface visibility less than 5/3/1 mile(s) respectively. In addition to the probability-based products, the GOES-R FLS algorithm also produces an estimation of the fog/low stratus thickness (cloud top height minus cloud base height). For the most part, the main products mentioned above have already been developed. However, only a few people outside of the algorithm developers have been trained to properly use and understand the products. For this reason, along with further algorithm development, we proposed to create a comprehensive training module that can be used to remotely train forecasters and other users on how to correctly interpret the GOES-R FLS products. Using this training module we want to formally introduce the GOES-R FLS products to the NWS, AWC, AAWU and OPC so they can start working with the products, evaluate them, provide feedback and eventually replace the traditionally-used 3.9-11  $\mu\text{m}$  BTD as they become more comfortable using them. We also proposed to find a relationship between the GOES-R FLS thickness product and the time it takes certain fog events to dissipate. This project will ensure the readiness of the fog/low cloud algorithm for operational implementation upon the deployment of GOES-R.

### **Summary of Accomplishments and Findings**

We determined the best way to train a large amount of forecasters to properly interpret the GOES-R FLS products was to create a comprehensive training module. One important aspect of the training module was to use region-specific examples so forecasters working in different parts of the country would see how the products look on real cases pertinent to their geography. This was relevant because forecasters are more familiar looking at certain FLS events common to their specific forecast area and are therefore more comfortable seeing how new products can be useful when looking for and identifying areas impacted by those events. The training module was created as a PowerPoint presentation and also converted into a VISIT training module. The VISIT training module is available at:

[http://rammb.cira.colostate.edu/training/visit/training\\_sessions/forecaster\\_training\\_for\\_the\\_goes-r\\_fog\\_low\\_stratus\\_products/](http://rammb.cira.colostate.edu/training/visit/training_sessions/forecaster_training_for_the_goes-r_fog_low_stratus_products/)

In the interest of keeping examples current, a running blog is also kept updated (usually several new entries per week) by Scott Lindstrom here at UW-Madison/CIMSS. This blog focuses on both common and uncommon FLS events from different geographic areas and shows in detail how the GOES-R FLS products can be used to identify hazardous areas of fog/low stratus in each. This blog can be found at: <http://fusedfog.blogspot.com/>.

At least 24 WFO's and 3 National Centers participated in various live GOES-R AWG FLS training sessions since September 1, 2012. A couple of NWS forecasters at the Sullivan, WI NWS WFO as well as 14 forecasters from the NWS Alaska Region (including the AAWU) were also trained in person by the algorithm developers during scheduled visits to their respective offices.



After training, numerous forecast offices in the NWS Alaska, Eastern, Central, and Western Regions started formally evaluating the GOES-R AWG FLS products. The first round of formal feedback has been collected in the form of questionnaires and surveys. This feedback indicated the vast majority of forecasters thought the products were useful (see Figure 9.12.1). One statistic that proves that forecasters are using the products is the number of local area forecast discussions (AFDs) where the GOES-R FLS products were mentioned. Since March 2012, the GOES-R FLS products have been cited in *at least* 50 AFDs. This number grows each week as more forecasters are getting comfortable using the products and use them in their daily routine. Forecasters in the AWC Winter Weather Experiment are also currently evaluating the GOES-R AWG FLS products (<http://goesrawt.blogspot.com/>). Along with the WFO's formally evaluating the products, several other NWS WFO's are receiving the GOES-R FLS products via a local data manager (LDM) feed and are looking at them using AWIPS. We are working with those WFO's to organize evaluation efforts, but even before this is set up, public mention of the GOES-R FLS products appears to show that they are being well-received and used in everyday operations (see Figure 9.12.2).

A linear relationship between the last nighttime fog/low stratus thickness estimation and the dissipation time for radiation fog events was also found. This relationship gives forecasters the estimated amount of time after sunrise that radiation fog will take to clear. This relationship only works for radiation fog events because different processes can influence other types of fog (e.g., advection fog) and make estimating dissipation time much more complicated. Tests performed on numerous radiation fog scenes have verified this relationship and have proven it to be accurate with only a small amount of error (usually much less than one hour). Initial feedback has shown that the GOES-R FLS thickness product and how it can be used to infer dissipation time is popular among some forecasters. During one high profile fog event near the Chicago area on November 21, 2012 the GOES-R products gave a forecaster enough confidence that fog would not clear in time to extend a dense fog advisory for several hours. The fog did indeed stick around several more hours before finally burning off, verifying the forecasters decision to extend the advisory.

### **Publications and Conference Reports**

An Overview of the GOES-R Fog/Low Stratus Algorithm. C. Calvert and M. Pavolonis, National Weather Association Annual Meeting. Madison, WI, October 2012.

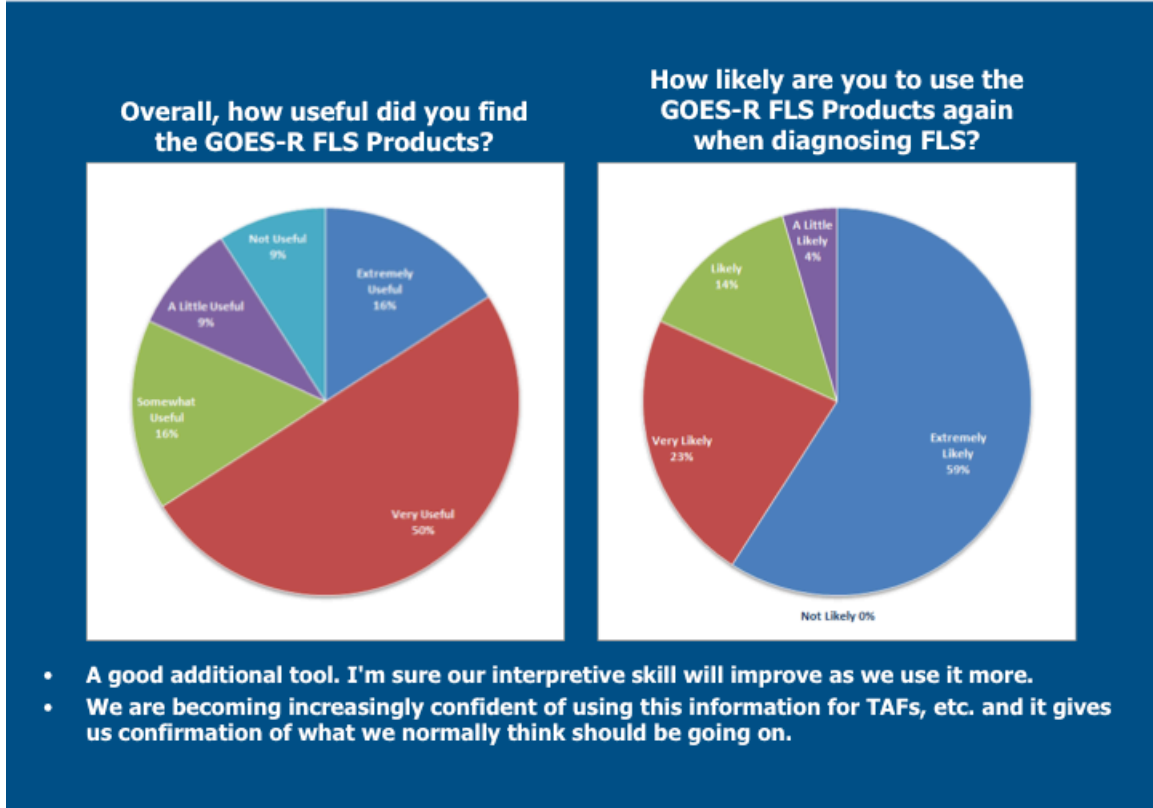
GOES-R Fog/Low Stratus Forecaster Feedback. C. Gravelle, M. Pavolonis and C. Calvert, National Weather Association Annual Meeting. Madison, WI, October 2012.

Results from the Central Region Evaluation of the GOES-R Fog/Low Stratus Products. C. Gravelle, M. Pavolonis and C. Calvert, 2nd NWS Eastern Region Virtual Satellite Workshop. February 2012.





## Feedback - Survey Results

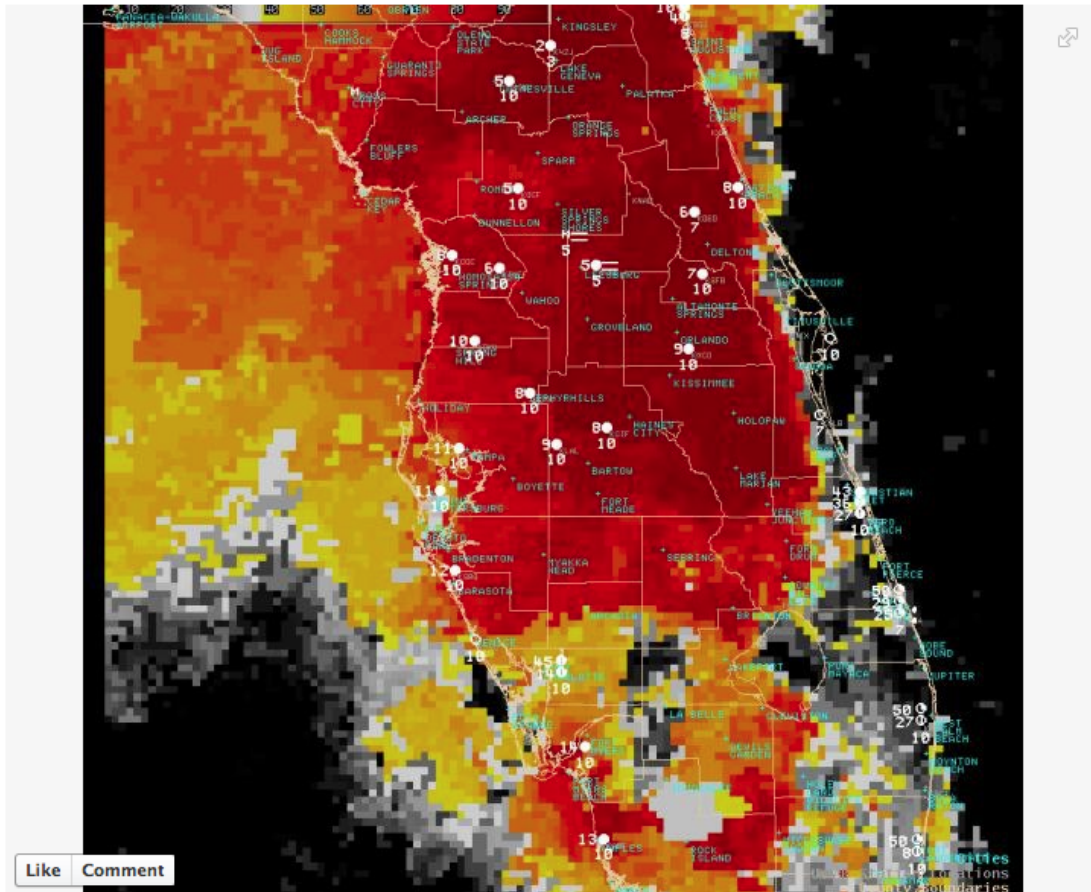


**Figure 9.12.1.** Results from an NWS Central region survey reveals that the vast majority of forecasters that evaluated the GOES-R AWG FLS products found them to be useful (left pie chart) and would like to continue using them (right pie chart).



### Timeline Photos

[Back to Album](#) · [US National Weather Service Tampa Bay Florida's Photos](#) · [US National Weather Service Tampa Bay Florida's Page](#)  
[Previous](#) · [Next](#)



**US National Weather Service Tampa Bay Florida**  
 Low clouds developing tonight will keep temperatures cooler along the Nature Coast and even into the Tampa Bay area later today.  
 Like · Comment · Share · December 14, 2012

👍 17 people like this.

📄 2 shares

**Judy Ann Smith Dunleavy** I want sunshine and warm weather  
 December 14, 2012 at 8:43am via mobile · Like

Write a comment...

Album: [Timeline Photos](#)  
 Shared with: Public

---

[Open Photo Viewer](#)  
[Download](#)  
[Mark as Spam](#)  
[Report/Remove Tag](#)

**Figure 9.12.2.** Screen capture of an entry on the NWS Tampa Bay, FL Facebook page highlighting the GOES-R IFR probability product on December 14, 2012.

## 10. CIMSS Participation in the Development of GOES-R Proving Ground

**CIMSS Task Leader: Wayne Feltz**

**CIMSS Support Scientists: Scott Bachmeier, Scott Lindstrom, Lee Cronce, Justin Sieglaff**

**NOAA Collaborators: Tim Schmit, Gary Wade**



### **NOAA Long Term Goals**

- Weather-Ready Nation

### **NOAA Strategic Goals**

- Serve society's needs for weather and water
- Support the nation's commerce with information for safe, efficient and environmentally sound transportation

### **CIMSS Research Themes**

- Satellite Meteorology Research and Applications
- Satellite Sensors and Techniques
- Education and Outreach

### **Proposed Work**

A proving ground provides resources for testing and validating ideas, technologies, and products before they are integrated into operational use. Implementation of a National Weather Service (NWS) proving ground for Geostationary Operational Environmental Satellite (GOES)-R would ensure that all changes, either technological or procedural, undergo rigorous integrated testing before implementation.

This proposal from the Cooperative Institute for Meteorological Satellite Studies (CIMSS) is to support the GOES-R Proving Ground activities. The proving ground concept allows developers at CIMSS and other research centers to be involved at an early stage in product development with forecasters, providing the opportunity for interaction between developers and users. GOES-R Proving Ground funding will support personnel, including satellite applications experts and computer and technical support at CIMSS, to work directly with NWS forecast offices and NOAA National Centers.

In 2013-2014, the Proving Ground will include two levels of interaction, national testbeds/PG demonstrations and regional/local collaborations. The first level of interaction will include supporting multiple NOAA testbeds (<http://www.esrl.noaa.gov/research/uswrp/testbeds/>) and/or Proving Ground demonstrations including the Hazardous Weather Testbed at the National Weather Center, the National Hurricane Center (NHC) PG demonstration, the Aviation Weather Testbed at the Aviation Weather Center (AWC), the NWS Training Center Testbed, the High Latitude PG demonstration at the Alaska Aviation Weather Unit, Satellite Applications Branch (SAB)/Ocean Prediction Center (OPC)/Hydrometeorological Prediction Center (HPC) PG demonstration, and Pacific Region PG demonstration. For the local level, CIMSS will build on close relationships already established with the NWS Forecast Offices at Milwaukee/Sullivan, Wisconsin. CIMSS interacts with over 50 NWS forecast offices in a limited capacity

In the GOES-R Proving Ground, developers and forecasters will test, apply, and evaluate GOES-R proxy algorithms for new GOES-R satellite data and products using proxy and simulated datasets, including GOES, MODIS/VIIRS, SEVIRI, and computer simulated products. These teams will test and validate the applications of these products in an operational setting.

### **Summary of Accomplishments and Findings**

In 2012, the primary focus was to test, apply, and improve select GOES-R satellite baseline, future capability, and risk reduction imagery/products in support of National Centers and local NWS offices. CIMSS participated in a March 2012 GOES-R Proving Ground review meeting in Kansas City, Kansas and regular GOES-R Proving Ground coordination/reporting teleconferences. GOES-R PG oral and poster presentations occurred at various conferences in 2012-2013 including the American Meteorological Society (AMS) Conference, the National



Weather Association (NWA) Conference, the 2012 AMS Severe Local Storms conference, and the EUMETSAT Annual conference in Sopot, Poland. Internet Web site access to GOES-R Proving Ground activities is hosted at: [http://cimss.ssec.wisc.edu/goes\\_r/proving-ground.html](http://cimss.ssec.wisc.edu/goes_r/proving-ground.html).

### ***Test and Apply Algorithms for Expected GOES-R Satellite Data Imagery/Products in Support of National NOAA Testbeds/PG Demonstrations***

The following Proving Ground activities occurred in 1 April 2012 – 30 March 2013 funding cycle where several GOE-R proxy decision support products developed at CIMSS were demonstrated with operational forecasters to obtain feedback:

- Hazardous Weather Testbed (HWT) Spring Experiment (7 May – 15 June). Participants included 28 forecasters and 16 visiting scientists;
- National Hurricane Center (NHC) Tropical Cyclone Demonstration (1 Aug. – 30 Nov.) Participants included forecasters from NHC;
- Aviation Weather Center (AWC) Summer Experiment (4 June – 15 June). Participants included AWC forecasters and FAA representatives;
- HPC/ OPC/ TAFB/ and SAB demonstrations (ongoing: focus on precipitation and ocean applications);
- High Latitude and Arctic Testbed (ongoing: focus on snow/ cloud/ volcanic ash/ and aviation applications). Participants include NWS Alaska Region;
- Air Quality (ongoing: focus on aerosol detection); and
- Pacific Region OCONUS Demonstration (ongoing: focus on tropical cyclones/ heavy rainfall/ and aviation applications). Participants include NWS forecasters and scientists from the University of Hawaii.

UW-Madison/CIMSS scientists were engaged with the demonstrations listed above by providing the following GOES-R Baseline, Future Capability, or Risk Reduction decision support proxy data. Product assessment highlights for eight of the UW-Madison/CIMSS decision support products are listed below as reported in the GOES-R PG 2012 Annual report and HWT/AWC/NHC Testbed final evaluation reports.

#### **1. *WRF Simulated ABI Synthetic Satellite Cloud and Moisture Imagery (Baseline)***

##### *HWT Input:*

In general, forecasters were very excited about the simulated satellite imagery and would like to have it provided within their operations. Many of the visiting NWS forecasters have already worked to bring this product into their forecast offices.

Synthetic Weather Research and Forecast (WRF) model-derived imagery can enhance forecasts by providing model data in a familiar satellite format which makes model analysis, model comparison to observations, and model forecast projections easier to visualize and understand.

##### *AWC Input:*

This product did a nice job picking-up on wave turbulence activity during the experiment. This showed the situational awareness utility of the product.

#### **2. *Hurricane Intensity Estimate (Baseline)***

##### *NHC Tropical Cyclone Demonstration:*

HSU forecasters indicated that the HIE was very responsive for Hurricane Michael and was used to upgrade it to a major hurricane. They also noted that the HIE intensity



estimates tended to be on the high side compared to other methods, especially when a storm first develops an eye.

3. ***GOES Imager Super Rapid Scan Operations Imagery (Baseline)***

*NHC Tropical Cyclone Demonstration:*

Both TAFB and HSU forecasters indicated that there is utility for center fixing, especially for weaker systems, and obtaining intensity and center fixes closer to synoptic times. The SRSO data have greater utility for monitoring changes in convective activity, especially for storms such as Hurricane Isaac when it was in the central Gulf of Mexico and its inner core circulation was the formative stage. TAFB forecasters also found the SRSO data useful for their tropical weather discussions, and helped document convection within tropical waves.

*HPC/OPC/TAFB and SAB Input:*

After Hurricane Isaac made landfall in southeast Louisiana, the new Metwatch desk at HPC found the 1-min rapid-scan imagery useful in identifying a mesohigh which was aiding in the development of a rainband along its periphery. The mesohigh features were easily displayed with the 1-min imagery bringing high confidence to the forecast.

4. ***Fog and Low Stratus Detection (Future Capability)***

The feedback from this product was very positive all around. However, there was one suggestion for improvement that a majority of the forecasters brought up. While they appreciated the IFR and LIFR differentiation, this also expressed a need for MVFR probability to help determine where VFR conditions are likely. In response, the MVFR probability product has been made available to AWC. These products are now being used in AWC routine operations.

*NWS Central Region Input:*

Within the Central Region (CR), 16 forecasters from 4 WFO's formally evaluated the GOES-R AWG fog/low cloud products. A post-evaluation survey indicated that 15/16 forecasters thought the products were useful, with 10/16 forecasters classifying the products as "very useful" or "extremely useful." In addition, the products were referenced in Area Forecast Discussions at various times by 4 CR forecasters.

*NWS Eastern Region Input:*

Two WFO's within the Eastern Region (ER) formally evaluated the GOES-R AWG fog/low cloud products. Formal feedback was collected from the 7 participating forecasters. All 7 forecasters indicated that the products were useful and they would continue to use the products. The GOES-R AWG products were referenced several times in Area Forecast Discussions in the ER.

5. ***University of Wisconsin Convective Cloud Top Cooling Rates (Future Capability)***

*HWT Input:*

Forecasters reported during their post event surveys that they used the University of Wisconsin CIMSS Cloud Top Cooling (UW-CTC) product during 89% of their warning operations. When forecasters were asked whether the CTC product provided signals beneath non-opaque cirrus clouds, the results were mostly positive. There were some occasions where the cirrus was just too thick and no cooling rate retrievals could be made. In other situations, forecasters reported that there was no cirrus over the area at all, so they could not determine the effectiveness of the CTC product where thin cirrus was



present.

Forecasters were asked to use the University of UW-CTC product in tandem with the SATCAST CI product to get an end-to-end picture of the CI process, from initial reflectivity signal on radar (from the 0-1 hr nowcast by SATCAST), to rapid intensification (as nowcast by UW-CTC), in an attempt to increase their warning lead-times on the occurrence of severe weather versus using radar alone. Forecasters were also encouraged to evaluate the UW-CTC as an additional warning decision support tool, where strong cooling rates (generally -20 C every 15 minutes or less) have been shown to have some correlation with the occurrence of severe hail (see Hartung et al., 2012).

Overall, the forecasters reported they would like more time to evaluate the product in their operations. Forecasters were asked in their post-event survey how much lead-time the UW-CTC product provided over the first occurrence of 60 dBZ composite reflectivity and 1.0" Maximum Expected Size of Hail (MESH). Responses varied from 10-90 minutes, but were most commonly around 30 minutes.

Forecasters said it was important to be aware of the surrounding environment before making a warning decision based on the UW-CTC product. Often if there was ongoing supercell activity, a forecaster would warn solely on the appearance of the UW-CTC signal exceeding about -20 C per 15 minutes.

In general, forecasters responded that they felt comfortable using UW-CTC in warning operations following the training that they received and that it worked as expected, with 93% reporting being comfortable using the product within the post-event surveys. Forecasters would like more time to play with the product to determine the appropriate cooling rate values that are associated with the occurrence of severe weather. They would also like more research done and solid statistics on the same topic. Forecasters are excited to see this product provided with higher temporal and spatial resolution. On occasion their lead-times were only limited by the time between satellite scans.

Forecasters were also asked if the UW-CTC product provided any additional confidence in their warning decision-making or if they issued a warning earlier than if they had NEXRAD data alone...

“CTC did enhance confidence/lead time for a severe warning. A warning was probably issued one scan before I would have without CTC, after seeing -20C/15 min rates.”

*NWS Forecaster, Post Event Survey*

“The UW-CTC rates exhibited greater than -35C/15 min for a particular storm on the southern extent of a broken line. The reflectivity aloft peaked with this storm about 45-60 minutes after the CTC signature, and a strong core of +45kt (near the surface) was observed around 30 minutes after the peak as well.”

*NWS Forecaster, Post Event Survey*

“If you looked at the day where there were the Dallas supercells, I found it really useful... I actually warned on the CTC and it worked out well... It preceded the 60 dBZ and 1" mesh by about 20-30 minutes.”



*NWS Forecaster, "Final EWP weekly debrief," GOES-R HWT Blog*

"Yesterday in Hastings we had a -34 C / 15 mins signal early on... there were some weaker storms ongoing at that time and it seemed like the stronger convection formed a little south of there afterwards... it definitely clued us in that something was going on."

*NWS Forecaster, "Final EWP weekly debrief," GOES-R HWT Blog*

"Based on the environment and the ongoing supercell activity, I issued the warning as soon as I saw the CTC... Without the CTC product, I may have issued the warning a scan or two later... which lead to a greater warning issuance lead time."

*NWS Forecaster, "Tales from the Testbed" Webinar, May 11*

"If the CTC got over -20 C / 15 mins anywhere other than over the terrain yesterday, there were really no false alarms... I did do one warning solely on the CTC, but it was on the terrain and never really did anything."

*NWS Forecaster, "EWP daily debrief 6/13," GOES-R HWT Blog*

*AWC Input:*

Reported that if the forecasters are aware of the convective environment, it provides excellent situational awareness. This product should be used as an additional tool in which to consult and gain confidence when forecasting for convective initiation. In particular, it was noted that it would be an excellent additional to the arsenal utilized for the Convective SIGMET (CSIG) desk, especially when deciding when to pick up or not pick up a certain area of developing convection.

**6. Convective Overshooting Tops/Enhanced-Vs (Future Capability)**

*AWC Input:*

These products assist in situational awareness where radar returns are not available, particularly in identifying the most intense areas of convection.

Generally it can be assumed that there is a high likelihood of moderate or greater turbulence associated with an OT, given the more intense updraft. As such, knowing which cell within a group of cells, or which portion of a squall line contained an OT would give the traffic flow managers an idea of which areas to direct traffic around or over, especially in cases where radar returns do not look particularly intense.

*NHC Tropical Cyclone Demonstration:*

More basic research is needed to understand the relationships between Tropical Overshooting Tops (TOTs) and intensification. TAFB indicated that the TOT product was useful for documenting convection in tropical waves. Hugh Cobb suggested that TAFB forecasters should make an effort to overlay the TOT locations on IR and visible imagery to better understand the relationships with tropical convection.

**7. Legacy Temperature and Moisture Profile - Nearcast Atmospheric Stability Indices (Risk Reduction)**

*HWT Input:*

According to post event surveys, forecasters reported using the Nearcast product in their



warning operations 70% of the time. In addition, forecasters were asked which fields (other than the long lived convective parameter and CAPE) helped delineate areas of convective development, inhibition and the relative strength of convection. In each instance, forecasters responded that the theta-e difference was the most useful, gaining more than 70% of the responses in each category. In each category, the low-level theta-e field had the second most responses.

Forecasters found the instability fields from the Nearcast products particularly useful in determining convective maintenance. The Nearcast product continues to be delivered within the SPC and HWT N-AWIPS workstations and is still available for demonstration in HWT AWIPS II systems.

*AWC Input:*

The product was very useful in terms of assessing where the atmosphere would be most favorable for convection should there be a trigger mechanism. It may aid in evaluating the evolution of mid-level instability in data void areas and between radiosonde launches in both space and time.

**8. Saharan Air Layer Product**

*NHC Tropical Cyclone Demonstration:*

The Saharan Air Layer (SAL) product imagery was provide by CIMSS to SPoRT, whom converted the image format to be compatible with N-AWIPS in order to display in the NHC operational system alongside other data. NHC forecasts found it much easier to use the product.

***Test and Apply Algorithms for New Satellite Data Imagery/Products in Support of Local Milwaukee Sullivan Office***

In addition, the Milwaukee-Sullivan National Weather Service Forecast Office is also receiving the real-time data feed via AWIPS and has provided additional operational feedback through UW-Madison/CIMSS researcher collaborations during forecaster shifts from 1 June – 31 October 2012. The CIMSS developers traveled once per week to the WFO in Sullivan/WI to work a 6-8 hour GOES-R PG shift one-on-one with a forecaster.

There were 15 evaluation shifts with emphasis on the GOES-R AWG low cloud product and the Synthetic GOES-R imagery from the NSSL WRF simulations. Forecasters provided feedback about the utility of the products in a blog entry this year as opposed to a formal survey. This form of feedback was more flexible and popular with the forecasters as this was the same blog used at the HWT in Norman OK.

***General Forecaster Feedback***

Bandwidth is an issue and may limit our ability to get all the data into AWIPS-II when GOES-R becomes operational in a few years. Forecasters want to emphasize that any solutions to overcome bandwidth limitations still provide them with the highest spatial resolution and the fastest temporal resolution. Lag times between image and availability in AWIPS-II should be minimal. If the whole image cannot be provided, then send WFOs a high resolution clip to preserve the native resolution.

In general, the raw products are preferred over derived products. One exception is the fog product, which is still provided at rather high resolution. The forecasters prefer products with





quantitative properties, rather than “yes/no” formats. For example, providing the actual Cloud Top Cooling Rate versus “Convective Initiation Likely.”

1. ***Synthetic Forecast imagery***

The simulated water vapor imagery serves as a proxy for identifying and tracking the evolution of upper level jets without having to rely solely on objective model output. The forecasters thought that simulated derived fog products using ABI simulated bands would be a good addition.

2. ***Low cloud/fog and probability of MVFR and IFR products***

The forecasters were concerned that not enough influence is given to the current observations (i.e., METAR cloud heights). This is a great product and has lots of potential for the operational environment. Forecasters noted that when there were breaks in the overcast (i.e., broken clouds), the algorithm tended to be too optimistic with the probabilities and assumed scattered clouds. However, all surface METARs tended to be BKN to OVC.

Specific MKX NWS forecaster blogs regarding this collaboration and decision support products can be found here:

<http://goesrhwt.blogspot.com/search/label/CIMSS-MKX>

***Final Remarks***

- These researcher/forecaster interactions are critical to best understand how and when to use a given product
- Adjustments to current products and development of new products have already resulted from these valuable interactions
- This iterative process works well with a continuous process of improvement on the GOES-R product suite

***Development of New GOES-R Weather Event Simulations and AWIPS-II Transition Support***

In 2012, new GOES-R Weather Event Simulation (WES) cases were developed for training NWS operational forecasters within their offices before participation in 2012 HWT. Specifically WES cases were developed for UW-CTC, Nearcasting, and Synthetic Imagery products. CIMSS remains committed to assuring a smooth transition of all CIMSS research to operations products from the existing AWIPS software to the upcoming AWIPS-II. Preliminary work has been done finding a new product implementation approach for AWIPS-II. AWIPS-II activities are rapidly accelerating on the national scale to transition local applications between the two software environments. An AWIPS archive capable of archiving 60 days worth of AWIPS formatted files has been acquired through SSEC funding to support easier generation of WES cases AWIPS-II will soon be accessible for use at CIMSS, with training modules employing the new AWIPS software included as part of the VISIT/COMET training programs for operational satellite meteorology professional development. UW-Madison/CIMSS participated in multiple GOES-R Proving Ground organizational and testbed/PG demonstration planning telecons.

***Publications and Conference Reports***

Identification of Convectively-Induced Aircraft Turbulence using Satellite Data, Sarah A. Monette, Kristopher M. Bedka, and Wayne F. Feltz. American Meteorological Society Annual Meeting, Austin, TX. Jan 6-10, 2013.



Total Lightning in a Multi-sensor Approach to the Detection and Forecasting of Convectively Induced Turbulence, Ryan Rogers, Larry Carey, Kris Bedka, Cecilia Fleegeer, Wayne Feltz, Sarah Monette. American Meteorological Society Annual Meeting, Austin, TX. Jan 6-10, 2013.

The GOES Objective Overshooting Top Signature Detection Product: Algorithm Description, Validation, and Applications, Kristopher Bedka, Richard Dworak, Lee Counce, and Wayne Feltz. 2<sup>nd</sup> National Weather Service Eastern Region Virtual Satellite Workshop, February 26, 2013.

Total Lightning in a Multi-sensor Approach to the Detection and Forecasting of Convectively Induced Turbulence, Ryan Rogers, Larry Carey, Kris Bedka, Cecilia Fleegeer, Wayne Feltz, Sarah Monette. NOAA Satellite Science Week Virtual Meeting, March 18-22, 2013.

Analysis of the Co-Evolution of Total Lightning, Ground-Based Radar-Derived Fields, and GOES-14 1-Minute Super Rapid Scan Satellite Observations of Deep Convective Cloud Tops, Kristopher Bedka, Cecilia Fleegeer, Ryan Rogers, Larry Carey, Wayne Feltz, and Jan Kanak. NOAA Satellite Science Week Virtual Meeting, March 18-22, 2013.

## References

Bedka, Kristopher M.; Dworak, Richard; Brunner, Jason and Feltz, Wayne. Validation of satellite-based objective overshooting cloud-top detection methods using CloudSat profiling radar observations. *Journal of Applied Meteorology and Climatology*, **51**, Issue 10, 2012, pp.1811-1822.

Bikos, Dan; Lindsey, Daniel T.; Otkin, Jason; Sieglaff, Justin; Grasso, Louie; Siewert, Chris; Correia, James Jr.; Coniglio, Michael; Rabin, Robert; Kain, John S. and Dembek, Scott. Synthetic satellite imagery for real-time high-resolution model evaluation. *Weather and Forecasting*, **27**, Issue 3, 2012, pp.784–795.

Dworak, Richard; Bedka, Kristopher; Brunner, Jason and Feltz, Wayne. Comparison between GOES-12 overshooting-top detections, WSR-88D radar reflectivity, and severe storm reports. *Weather and Forecasting*, **27**, Issue 3, 2012, pp.684–699.

Goodman, Steven J.; Gurka, James; DeMaria, Mark; Schmit, Timothy J.; Mostek, Anthony; Jedlovec, Gary; Siewert, Chris; Feltz, Wayne; Gerth, Jordan; Brummer, Renate; Miller, Steven; Reed, Connie and Reynolds, Richard R.. The GOES-R Proving Ground: Accelerating user readiness for the next-generation geostationary environmental satellite system. *Bulletin of the American Meteorological Society*, **93**, Issue 7, 2012, pp.1029–1040.

Lakshimanam, Valliappa; Rabin, Robert; Otkin, Jason; Kain, John S. and Dembek, Scott. Visualizing Model Data Using a Fast Approximation of a Radiative Transfer Model. *Journal of Atmospheric and Oceanic Technology*, **29**, Issue 5, 2012, pp.745–754.

Lindsey, Daniel T.; Schmit, Timothy J.; MacKenzie, Wayne M. Jr.; Jewett, Christopher P.; Gunshor, Mat M. and Grasso, Louie. 10.35 micron: Atmospheric window on the GOES-R Advanced Baseline imager with less moisture attenuation. *Journal of Applied Remote Sensing*, **6**, 2012, doi:10.1117/1.JRS.6.063598.

Miller, Steven D.; Schmidt, Christopher C.; Schmit, Timothy J. and Hillger, Donald W.. A case for natural colour imagery from geostationary satellites, and an approximation for the GOES-R ABI. *International Journal of Remote Sensing*, **33**, Issue 13, 2012, pp.3999-4028.



Monette, Sarah A., Christopher S. Velden, Kyle S. Griffin, Christopher M. Rozoff, 2012: Examining Trends in Satellite-Detected Tropical Overshooting Tops as a Potential Predictor of Tropical Cyclone Rapid Intensification. *J. Appl. Meteor. Climatol.*, **51**, 1917–1930. doi: <http://dx.doi.org/10.1175/JAMC-D-11-0230.1>

Schmit, Tim. The ABI on GOES-R. National Weather Association Newsletter, 2012, pp.4.

## **11. X/L-Band Polar Orbiting Satellite Direct Broadcast Reception Station and Automated Processing System for the NWS, Hawaii**

**CIMSS Task Leader: Liam Gumley**

**CIMSS Support Scientists: Kathy Strabala, Jordan Gerth**

**NOAA Collaborators: Mitch Goldberg, Bill Ward**

**NOAA Long Term Goals**

- Weather-Ready Nation

**NOAA Strategic Goals**

- Serve society's needs for weather and water
- Provide critical support for the NOAA mission

**CIMSS Research Themes**

- Satellite Meteorology Research and Applications
- Satellite Sensors and Techniques

### **Proposed Work**

SSEC/CIMSS proposed to install a turnkey solution for the National Weather Service in Honolulu HI to enable real-time acquisition and processing of data from polar orbiting satellites including:

- JPSS NPP,
- NASA Terra and Aqua,
- NOAA POES,
- EUMETSAT Metop, and
- CMA FY-1 and FY-3.

The system includes a highly reliable 2.4 meter diameter X/L-band ground station for satellite data acquisition; an automated data processing system for creating a diverse array of satellite products; and an interface to the National Weather Service Advanced Weather Interactive Processing System (AWIPS) for real-time product display and analysis.

SSEC/CIMSS proposed to provide project management for pre-installation planning, installation support, system setup and testing, end user training, and ongoing software support for product generation.

### **Summary of Accomplishments and Findings**

The complete hardware and software system was installed in Honolulu on August 8, 2012. The satellite data acquisition system includes a state-of-the-art antenna positioner and 2.4-meter diameter reflector from Orbital Systems, a leader in the global market for satellite ground stations. The system is designed to reliably meet performance requirements year after year without expensive maintenance in extreme weather conditions. The latest motor and gear technologies are used to provide accurate, long life, and reliable positioning. Absolute position



encoders are used to eliminate indexing and provide full range accuracy. The system is protected from the environment with a tightly sealed design that uses pressurized dry air to eliminate condensing humidity and corrosion. The data acquisition system includes the following components:

- Orbital Systems 2.4AEHP antenna positioner with a 2.4 meter reflector;
- FDXL-B concentric X-band and L-band feed with an internally mounted tunable downconverter for X-band and a block converter for L-band;
- HRD-200 X band demodulator;
- LRD-200 L band demodulator;
- EOS-FES front end server hardware (HP rack mount server);
- EOS-FES software for antenna control, pass scheduling, and data ingest;
- Compatibility with NPP, Terra, Aqua, POES, Metop, FY-1, and FY-3;
- PMT200B Dehydrator; and
- Documentation for the antenna hardware and EOS-FES server.

Features of the satellite data acquisition system include:

- A complete and fully integrated bundle which receives X and L band direct broadcast data and processes it to Level 0 for all supported satellites;
- High performance versions of industry standard Quorum Communications RF components are utilized;
- System provides a high reliability antenna positioner and straightforward graphical user interface so researchers spend their valuable time focusing on the data (not the antenna);
- EOS-FES ties together and synchronizes all system components to automate passes, track satellites, receive, ingest, and then process data to Level 0;
- Automatic TLE updates as well as remote diagnosis and software updates; and
- Remote support and assistance are available for integration with customer's application processing software.

Product generation is accomplished by a dual-CPU HP Rackmount server collocated with the antenna control server. The data processing server has two Intel hex-core CPUs, 48GB of RAM, and 8TB of disk space. It is connected to the antenna control server via a private Gigabit network to allow fast transfer of raw data (e.g., CADU, PDS, HRPT) when a satellite pass is complete. SSEC/CIMSS managed the setup and installation of the product generation software on the data processing server, and it is currently creating real-time products from Suomi NPP VIIRS, CrIS, ATMS, and Terra/Aqua MODIS. The system includes sufficient disk space to maintain a 14-day rolling archive of satellite data products and images. If desired, the system can be upgraded with additional hard drives (up to 16TB) to provide up to 5 years of archive capacity for Level 0 products in compressed format. Real-time processing of satellite data products is accomplished by the Direct Broadcast Processing System (DBPS) software package developed at SSEC/CIMSS. The DBPS is a Linux-based processing system for direct broadcast data from polar orbiting satellites, and creates a diverse set of atmosphere, land, and ocean products. The DBPS processing system is designed to run automatically and reliably, and is easy to configure and maintain. User-defined processing algorithms may be added easily, and the system is designed to be operated and maintained by end-users who are not system administrators or experts in Linux systems.

The processing system creates the following suite of products from direct broadcast satellite data.



## **Suomi NPP Products**

### **VIIRS SDR Products**

- M-band radiances, reflectances, brightness temperatures, and geolocation
- I-band radiances, reflectances, brightness temperatures, and geolocation
- Day/Night band radiances and geolocation

### **CrIS SDR Products**

- CrIS radiances and geolocation

### **ATMS SDR Products**

- ATMS antenna temperatures and geolocation

### **VIIRS Image Products**

- M-band and I-band visible and infrared imagery for AWIPS (delivered via LDM to NWS)
- Day/Night band imagery for AWIPS (delivered via LDM to NWS)

## **Terra and Aqua Products**

### **MODIS Level 1B Products**

- Level 0 quicklook images (visible and infrared; sensor projection)
- Level 1B 1KM, HKM, and QKM radiances and geolocation
- Destriping corrections for Level 1B 1KM infrared radiances

### **MODIS Atmosphere Products**

- Cloud Mask
- Cloud Top Pressure, Phase, Effective Emissivity, Optical Depth
- Aerosol Optical Depth
- Temperature and Water Vapor Profiles
- Total Column Precipitable Water Vapor (Infrared, Day/Night)
- Total Column Ozone
- Total Column Precipitable Water Vapor (Near-Infrared, Day only)
- Level 2 browse images for all Atmosphere Products

### **MODIS Land Products**

- Corrected Reflectance
- Fire Detection / Thermal Anomalies
- Land Surface Temperature (LST)
- Normalized Difference Vegetation Index (NDVI)
- Enhanced Vegetation Index (EVI)
- Land Surface Reflectance

### **MODIS Ocean Products**

- Normalized water-leaving radiance at 412, 443, 488, 531, 551, 667 nm
- Aerosol optical thickness at 869 nm
- Epsilon of aerosol correction at 748 and 869 nm
- OC3 Chlorophyll-a concentration
- Diffuse attenuation coefficient at 490nm
- Angstrom coefficient, 531-869 nm
- Sea Surface Temperature: 11 micron
- Sea Surface Temperature: 4 micron (night only)



### ***MODIS Images in GeoTIFF and JPEG Format***

- Level 1B browse images (visible, infrared, true color)
- Level 2 Land browse images (NDVI, LST)
- Level 2 Ocean browse images (Chlorophyll-A, SST)

### ***MODIS Google Earth KML***

- MODIS 250 meter resolution true color JPEG images and KML

NOAA POES, Metop, and FY-3 products will be added to the system in a future software update.

### ***AWIPS Integration***

The processing system includes automated software to convert selected output products into the Network Common Data Format (netCDF) required for display in the Advanced Weather Interactive Processing System (AWIPS). Once the files are converted to the appropriate netCDF format and naming convention, the files are compressed and transferred to the NWS Office using the Unidata Local Data Manager (LDM). On the NWS local data ingest side, the files are unpacked on arrival and stored in the appropriate local directory structure. Simple enhancements will produce new menus that allow for the display of these new products in the AWIPS client desktop environment.

### ***Training***

Training was conducted at the customer location (University of Hawaii) on both system operation and maintenance, and derived product applications. The training consisted of the following modules:

- Antenna and acquisition system operations and maintenance (presented by the antenna vendor),
- Processing system operation and maintenance (presented by SSEC/CIMSS), and
- Product applications (presented by SSEC/CIMSS).

Further in-depth training will be conducted on-site in August 2013.



**Figure 11.1.** X/L-band antenna installed at Honolulu Community College on 8 August 2012.

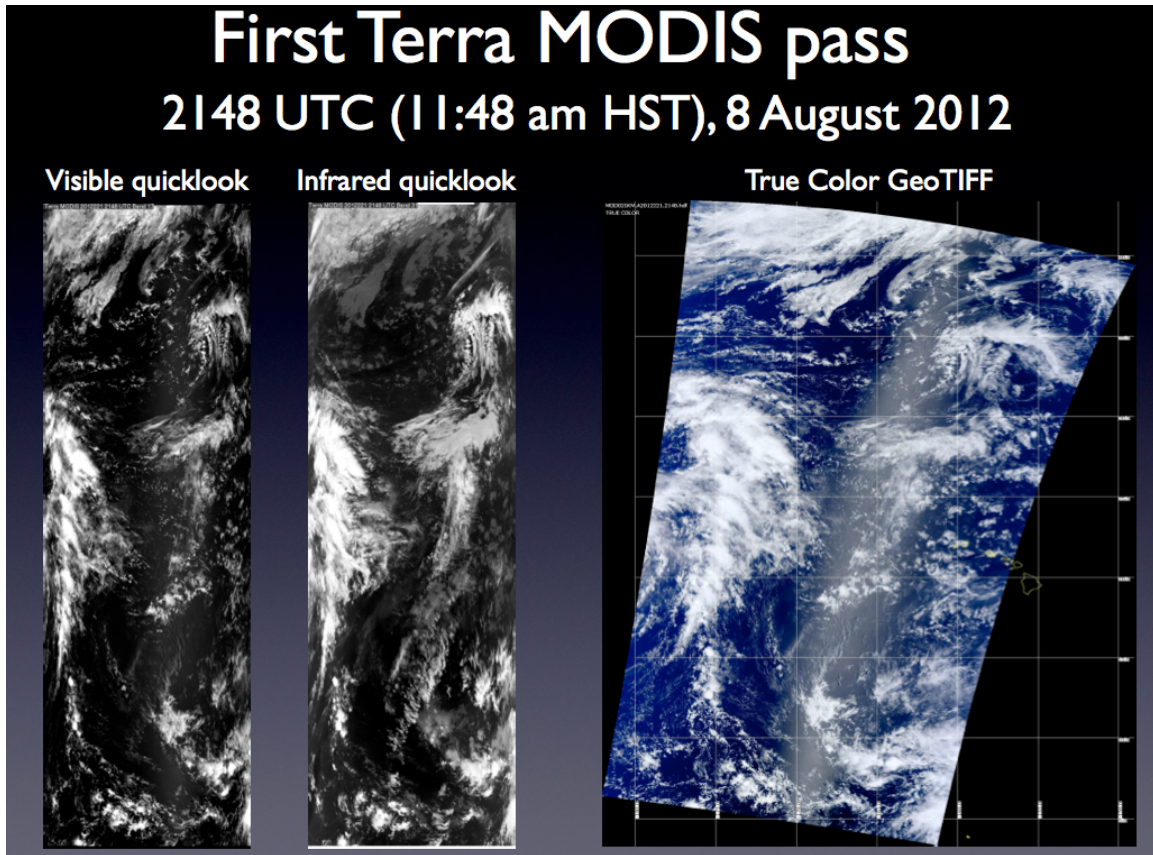


Figure 11.2. First satellite pass captured by antenna at HCC on 8 August 2012.

## 12. CIMSS High Impact Weather Studies with GOES-R and Advanced Soundings

**CIMSS Task Leader: Jun Li**

**CIMSS Support Scientists: Jinlong Li, Pei Wang, Kevin Baggett**

**NOAA Collaborator: Tim Schmit**

**NOAA Long Term Goals**

- Weather-Ready Nation

**NOAA Strategic Goals**

- Serve society's needs for weather and water
- Provide critical support for the NOAA mission

**CIMSS Research Themes**

- Satellite Meteorology Research and Applications
- Environmental Models and Data Assimilation

### Proposed Work

This proposal is for the University of Wisconsin-Madison's Cooperative Institute for Meteorological Satellite Studies (CIMSS) to study the use of the combined the advanced imaging product from the next generation Geostationary Operational Environmental Satellite (GOES-R) and the advanced infrared (IR) sounding product from polar-orbiting satellites for high impact weather warning, nowcasting and short range forecast applications. Severe weather warning, monitoring and forecasting requires nearly continuous monitoring of the vertical temperature and moisture structure of the atmosphere on various spatial scales, the value of combining high spatial





and temporal resolution GOES-R Advanced Baseline Imager (ABI) and the advanced IR sounder observations for high impact weather (convective storms, tropical cyclones, etc.) warning, nowcasting and short-range forecasting are studied and demonstrated using the Atmospheric InfraRed Sounder (AIRS), Cross-track Infrared Sounder (CrIS), Moderate Resolution Imaging Spectroradiometer (MODIS), Advanced Microwave Scanning Radiometer (AMSR) and the current GOES Sounder observations.

### **Summary of Accomplishments and Findings**

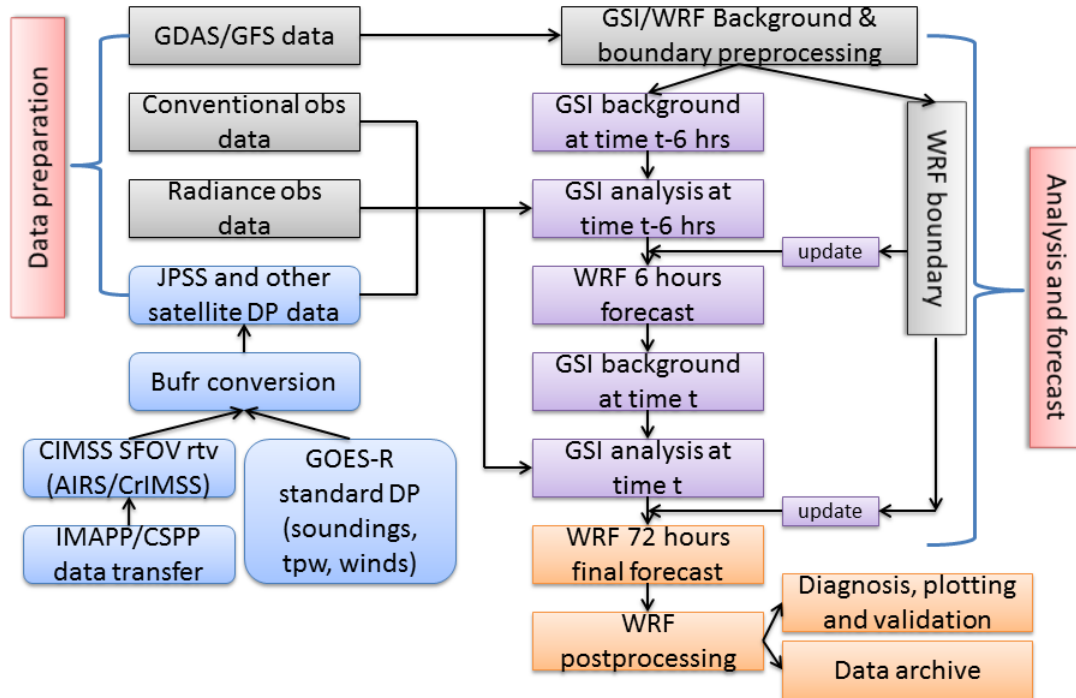
CIMSS sounding team have developed a demonstration system – satellite Sounder Data Assimilation for Tropical cyclone forecasts (SDAT) which comprises of data ingesting, assimilation and forecasting. SDAT is built upon the combination of Weather Research Forecast (WRF) and the community Gridpoint Statistical Interpolation (GSI) system, and is able to assimilate both the GOES-R products (such as legacy soundings, total precipitable water, AMVs, and water vapor channel radiances) and the JPSS sounder data (CrIMSS soundings or radiances). SDAT has been used for hurricane Sandy forecast experiments at STAR super computer S4 (satellite simulations and data assimilation studies) physically located at SSEC/CIMSS. By assimilating sounding products SDAT shows better forecasts (both track and intensity) than the operational models (GFS and HWRF), which demonstrates the importance of satellite data for hurricane forecasts. The goal of this research is to pave the way towards operational use of GOES-R data. Detailed accomplishments are described below.

### ***Design and Develop a Demonstration System for Tropical Cyclone Forecasts with Combined GOES-R Water Vapor and JPSS Sounder Data***

Reliable and stable forecasts on tropical cyclones (TCs) such as Isaac and Sandy which landed on the Continental United States (CONUS) in 2012 are critical for decision making and better preparation. Observations of atmospheric temperature and moisture information in the environment region are very important to the prediction of the genesis, intensification, motion, rainfall potential, and landfall impacts of TCs through numerical weather prediction (NWP) models. A recent study (<http://phys.org/news/2012-11-nasa-hurricane-strength.html>) by JPL scientists (Wu et al., 2012) found the hurricanes that rapidly intensified tended to exist within a moister large-scale environment than weaker storms. The rapidly intensifying hurricanes had statistically significant higher relative-humidity levels in their environments than storms whose intensity was weakening or unchanged. This study indicates that forecasters could be better able to predict how intense tropical cyclones like Hurricane Sandy will become by using water vapor information from GOES-R within their large-scale environments. In order to enhance the application of GOES-R water vapor measurements, a demonstration system is being developed for assimilating combined GOES-R water vapor and JPSS sounder data for tropical cyclone (TC) forecasts. The system is at the current available infrastructure (STAR super computer S4) at SSEC/CIMSS. The following figure shows the flowchart of GOES-R/JPSS assimilation system for TC forecast (see Figure 12.1).



## Demonstration system flowchart for JPSS CrIMSS application to hurricane forecast



**Figure 12.1.** Flowchart of GOES-R (legacy soundings, tpw, winds) and JPSS sounding assimilation system for tropical cyclone forecasts.

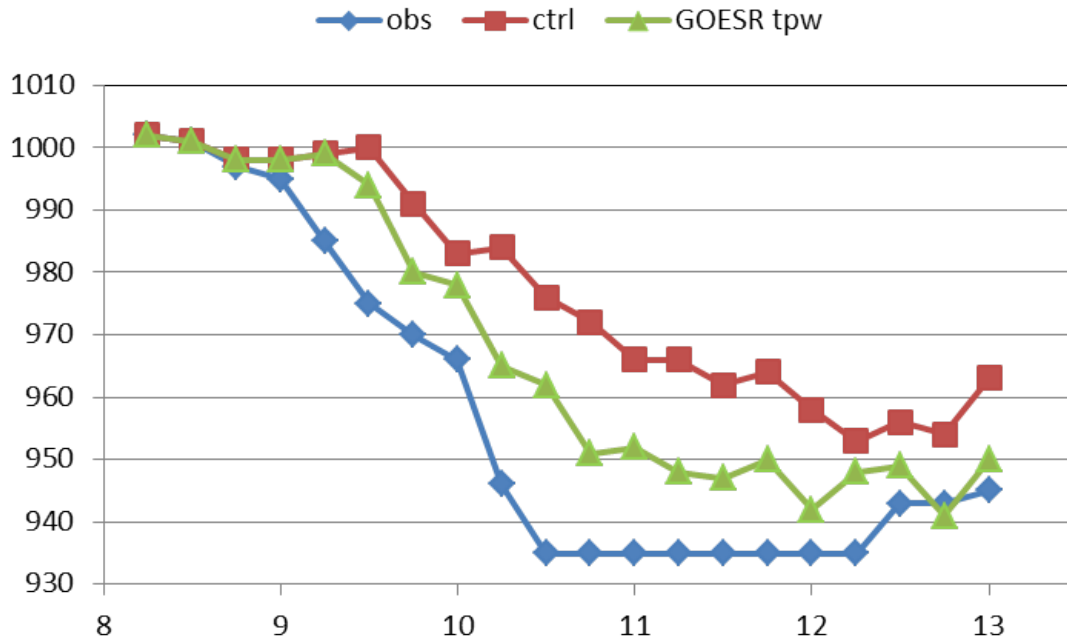
As seen in the diagram, the demonstration system mainly consists of three major parts. The first part is the data preparation, the second part is the data assimilation and the third part is forecasting. The latest community Gridpoint Statistical Interpolation (GSI) system and Weather Research Forecast (WRF) model is the core of our assimilation and forecast system. The NOAA National Centers for Environment Prediction (NCEP) global forecast system (GFS) output will be used as GSI/WRF background and boundary input information. All conventional observations and satellite radiances data (GOES-R and JPSS) can also be obtained from NOAA/NCEP real time forecast system. In addition to the regular data from NCEP, some specific satellite derived products can be processed at CIMSS. We have developed the capability to ingest GOES-R derived products (e.g., TPW – total precipitable water, winds) into BUFR file for assimilation application. GSI/WRF is designed to assimilate data every 6 hours (can be assimilated more frequently if computer resource allows) followed by 72-hour forecasts.

### **Multiple LEO Satellite Water Vapor Measurements Used for GOES-R WV Proxy in Assimilation Experiments**

Ideally, GOES Sounder should be used as proxy for GOES-R in high impact weather studies, however, since GOES Sounder has limited spatial coverage, we use water vapor measurements from multiple LEO (polar-orbiting) satellites to emulate the GOES-R water vapor measurements (total precipitable water in this study). TPW measurements from Moderate Resolution Imaging Spectroradiometer (MODIS) and Advanced Microwave Scanning Radiometer - Earth Observing System (AMSR-E) are used to demonstrate the impact of GOES-R water vapor measurements on tropical cyclone analysis and forecasts. Figure 12.2 shows Typhoon Sinlaku sea level pressure



(SLP) analysis for September 8 - 13, 2008 from control and TPW (MODIS and AMSR-E) assimilation, along with the observations. The control run assimilates radiosondes, satellite AMVs, QuickSCAT winds, COSMIC GPS-RO, ship and land surface observations. The water vapor measurements (TPW) provide a much better analysis for intensity than the control run.



**Figure 12.2.** Typhoon Sinlaku sea level pressure analysis for September 8 - 13, 2008 from control and TPW assimilation along with the observations.

In summary, these results are encouraging and suggest a positive impact of GOES-R water vapor information for forecasting hurricane tracks and intensity. This progress has been reported in NOAA/NESDIS's Joint Center for Satellite Data Assimilation (JCSDA) newsletter (March 2012), see the following link for the newsletter: (<http://www.jcsda.noaa.gov/documents/newsletters/201203JCSDAQarterly.pdf>).

### ***Experiments on Assimilating Moisture Information from Multiple Satellites (GOES-R Water Vapor Proxy) for Superstorm Sandy***

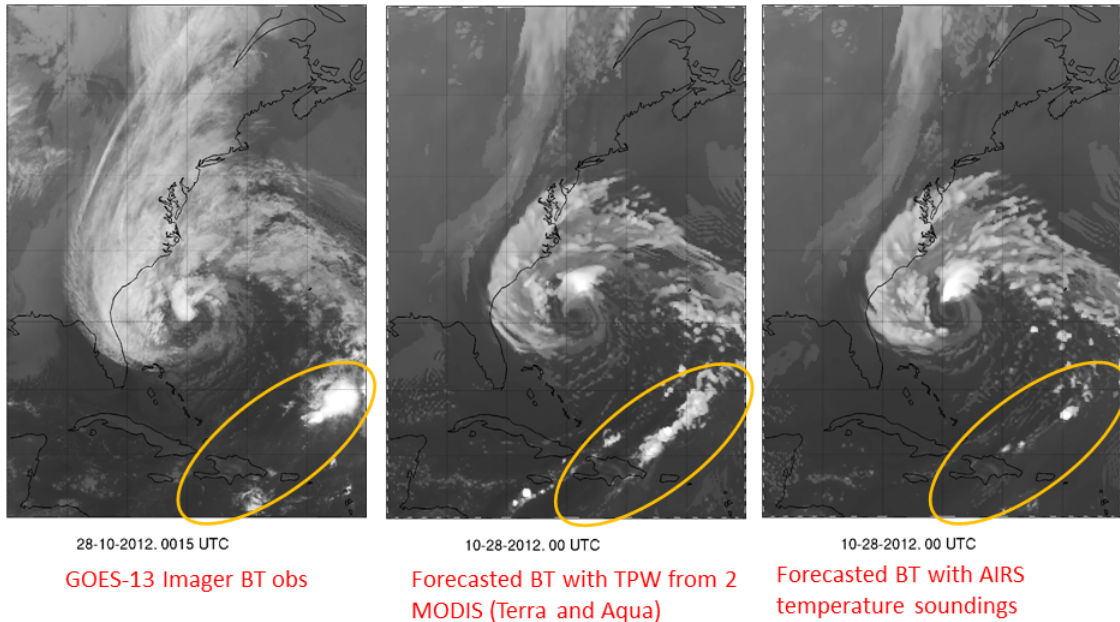
We have conducted the total precipitable water (TPW) assimilation for hurricane Sandy (2012) forecast experiments, three types of data are used in the experiments: (a) GTS - data obtained through WMO's global telecommunication system, GTS contains all the conventional data and other related data, (b) TPW over ocean from MODIS onboard Terra/Aqua – TPW derived with GOES-R legacy atmospheric profile (LAP) algorithm), and (c) GOES Sounder TPW – TPW derived from GOES-13 and GOES-15 Sounders with GOES-R LAP algorithm.

The forecast experiments are conducted in WRF/GSI with 12 km spatial resolution, in order to investigate the impact of using moisture data for Sandy forecasts, GTS+TPW data are used in the experiments. Data are assimilated every 6 hours followed by 72 hour forecasts. The assimilation window is +/- 30 minutes. The experimental forecasts are converted to GOES-13 Imager 11  $\mu$ m brightness temperatures (BTs) and verified with GOES-13 BT measurements. Figure 12.3 shows the forecasted BT with MODIS TPW (middle panel) and AIRS temperature sounding (right panel) assimilated, respectively, along with the GOES-13 Imager BT measurements (left panel). It indicates the improvement on forecasting the mesoscale features during their developing stage



with moisture observations assimilated. With AIRS temperature soundings assimilated, the mesoscale features are still difficult to be picked by the regional NWP model.

### Forecasts (started at 18 UTC 27 October 2012) verification



**Figure 12.3.** The forecasted BT with MODIS TPW (middle panel) and AIRS temperature sounding (right panel) assimilated, respectively, along with the GOES-13 Imager BT measurements (left panel).

More experiments are ongoing to include GOES Sounder, SSMI and MODIS TPW altogether demonstrating the advantage of using frequently observed moisture data.

#### Publications and Conference Reports

Li, J., P. Wang, T. Schmit, C. Velden, and Jinlong Li, 2013: Improving tropical cyclone forecasts with advanced sounding measurements from satellites, IOAS/TROPICALSYMP, AMS 93rd Annual Meeting, 06 – 10 Jan 2013, Austin, TX.

Li, J., T. Schmit, P. Wang, C. Velden, Jinlong Li, Z. Li, and W. Bai, 2013: Improving tropical cyclone forecasts in regional NWP with GOES-R water vapor and JPSS sounder measurements, JCSDA Session at the 93rd AMS Annual Meeting 06 – 10 Jan 2013, Austin, TX.

Wang, P., J. Li, T. Schmit, J. Li, Z. Li, and W. Bai, 2013: Improve tropical cyclone forecasts with hyperspectral infrared sounder data, AMS 93rd Annual Meeting, 06 – 10 Jan 2013, Austin, TX.

Li, J., 2012: Assimilation of satellite data in regional NWP - progress and challenges, invited talk at the NSF sponsored Earth Cube Workshop – Shaping the Development of EarthCube to Enable Advances in Data Assimilation and Ensemble Prediction, 17 – 18 December 2012, Boulder, Colorado.



Zheng, J., J. Li, Jinlong Li, and T. J. Schmit, 2012: Assimilating AIRS Soundings with WRF/3DVAR for Hurricane Forecast Improvement. *Journal of Applied Meteorology and Climate* (submitted).

Li, Jun; C.-Y. Liu, P. Zhang, and T. J. Schmit, 2012: Applications of full spatial resolution space-based advanced infrared soundings in the preconvection environment. *Weather and Forecasting*, **27**, 515 - 524.

Kwon, Eun-Han; Jun Li, Jinlong Li; B. J. Sohn, and E. Weisz, 2012: Use of total precipitable water classification of a priori error and quality control in atmospheric temperature and water vapor sounding retrieval. *Advances in Atmospheric Sciences*, **29**, 263 - 273.

Yao, Z., Jun Li, and Jinlong Li, 2012: Sunglint impact on atmospheric soundings from hyperspectral resolution infrared radiances. *Advances in Atmospheric Sciences*, **29**, 455 - 463.

## References

Kwon, Eun-Han; Jun Li, Jinlong Li; B. J. Sohn, and E. Weisz, 2012: Use of total precipitable water classification of a priori error and quality control in atmospheric temperature and water vapor sounding retrieval. *Advances in Atmospheric Sciences*, **29**, 263 - 273.

Li, J., C.-Y. Liu, P. Zhang, and T. J. Schmit, 2012: Applications of full spatial resolution space-based advanced infrared soundings in the preconvection environment. *Weather and Forecasting*, **27**, 515 - 524.

Li, J., H. Liu, 2009: Improved Hurricane Track and Intensity Forecast Using Single Field-of-View Advanced IR Sounding Measurements. *Geophysical Research Letters*, **36**, L11813, doi:10.1029/2009GL038285.

Li, J., Jinlong Li, T. J. Schmit, and J. Otkin, 2011: Warning information in pre-convection environment from geostationary advanced infrared sounding system - a simulation using IHOP case. *Journal of Applied Meteorology and Climate*, **50**, 776 - 783.

Liu, H., and J. Li, 2010: An improved in forecasting rapid intensification of Typhoon Sinlaku (2008) using clear-sky full spatial resolution advanced IR soundings. *J. Appl. Meteorol. and Cli.*, **49**, 821 - 827.

Reale, O., J. Susskind, R. Rosenberg, E. Brin, E. Liu, L. P. Riishojgaard, J. Terry, and J. C. Jusem, 2008: Improving forecast skill by assimilation of quality-controlled AIRS temperature retrievals under partially cloudy conditions. *Geophys. Res. Lett.*, **35**, L08809, doi:10.1029/2007GL033002.

Schmit, T. J., M. M. Gunshor, W. Paul Menzel, J. Gurka, J. Li, and S. Bachmeier, 2005: Introducing the next-generation advanced baseline imager (ABI) on GOES-R. *Bull. Amer. Meteorol. Soc.*, **86**, 1079-1096.

Schmit, T. J., J. Li, S. A. Ackerman, and J. J. Gurka, 2009: High spectral and temporal resolution infrared measurements from geostationary orbit. *Journal of Atmospheric and Oceanic Technology*, **26**, 2273 - 2292.



Schmit, T. J., J. Li, J. J. Gurka, M. D. Goldberg, K. Schrab, J. Li, W. Feltz, 2008: The GOES-R ABI (Advanced Baseline Imager) and the continuation of current sounder products. *J. of Appl. Meteor.*, **47**, 2696–2711.

Zheng, J., J. Li, Jinlong Li, and T. J. Schmit, 2012: Assimilating AIRS Soundings with WRF/3DVAR for Hurricane Forecast Improvement. *Journal of Applied Meteorology and Climate* (submitted).

### **13. Investigations in Support of the GOES-R Program Office**

**CIMSS Task Leader: Paul Menzel**

**NOAA Collaborator: Steve Goodman**

#### **NOAA Long Term Goals**

1. Climate Adaptation and Mitigation
2. Weather-Ready Nation

#### **NOAA Strategic Goals**

1. Serve society's needs for weather and water
2. Understand climate variability and change to enhance society's ability to plan and respond
3. Provide critical support for the NOAA mission

#### **CIMSS Research Themes**

- Theme 1. Satellite Meteorology Research and Applications  
Theme 2. Satellite Sensors and Techniques

#### **Proposed Work**

CIMSS Senior Scientist Dr. W. Paul Menzel, in collaboration with the NOAA GOES-R Program Office, will conduct and stimulate research on environmental remote sensing systems that helps to guide evolution of the NOAA satellite holdings. This will include facilitating research demonstrations of new capabilities from GOES-R and JPSS, participating in the Technical Advisory Committee and other evaluation boards, presenting results at appropriate venues, and collaborating with international partners pursuing the same goals.

### **Summary of Accomplishments and Findings**

#### **Participation in NOAA Satellite Science Week**

On 30 April to 2 May I attended the NOAA Satellite Science Week in Kansas City, MO and participated in the Independent Advisory Committee evaluations of progress on GOES-R option 2 algorithms, proving ground activities, risk reduction research, and LEO and GEO enterprise consolidation of algorithms. I offered the following comments.

1. Scientists must remain close to their algorithms during operational implementation - his/her role in product production efficiency, validation, and evolution must be enabled by closer communication / collaboration with the vendor of the ground system.
2. Preparations must be made for rapid software updates with scientist engagement as experience with real data reveals issues (data striping, rectification issues, geo diffraction effects, missing or saturated data ...). There will be situations when the algorithm change process is going from «broken to working » rather than from « adequate to better ». Update strategies to be used before Day 1 and after Day 1 need to be drafted. A pre-planned product improvement must be developed for the program. Recommendation: Scientist access to Himawari data and documentation of differences from GOES-R



- should be arranged so that experience with real ABI data can mitigate some issues before GOES-R launch.
3. Optimal GOES-R scanning and pre-processing scenarios still need exploration (e.g., scan south to north for more timely NH data, de-striping before rectification).  
Recommendation: Undertake a study to demonstrate the difference in GOES perfect projection data when destriped then rectified versus rectified then destriped (information about image construction from scanning detector array needs to be made available).
  4. Preparations for routine production of option 2 products (prior to operational production) appear to be underway as part of the enterprise processing system. Recommendation: These should be sustained as much as possible so that affiliated scientists get an opportunity for evaluation with ABI data and the user community gets familiar with the product.
  5. Opportunity for LEO supplement / complement to GEO measurements for product generation has been enhanced greatly by the established of the enterprise processing system. More efforts should be encouraged for combined products where LEO benchmarks are temporally continued with GEO measurements. An example could be LEO day-night band observations of fog can be extended into early morning with GEO visible composites. Caveats are that LEO and GEO must provide coherent depictions hence physics issues need attention (e.g., viewing angle differences, diffraction issues from GEO but not LEO ...). For example, LEO vs. GEO Vis/NIR algorithms must account for viewing angle and solar illumination differences characterizing the two systems.
  6. Better utilization of temporal continuity for product generation and QC is progressing. Some algorithms are now making good use of the temporal advantages offered by geostationary measurements; all algorithm developers should re-consider ways to make better use for consistency checks and / or QC.
  7. Product validation needs better articulation / planning. Post-launch validation must include considerations for field experiments; leveraging and contributing to existing plans for NASA/DOE/NOAA field experiments must be undertaken. Recommendation: Post launch plans should be presented at next conference.
  8. Data assimilation of hourly radiance / products in NWP models (4DVAR) needs more attention - JCSDA efforts in this direction need to be encouraged. Moreover, use of satellite data over land (surface viewing as well as upper tropospheric / lower stratospheric sensitive measurements) in NWP needs to be enhanced.
  9. ABI does not offer a sounding product; ABI offers layer adjustments to a NWP model initial vertical profile estimate. This must be made clear in the product designation. Use of the word “sounding” is totally inappropriate and misleading. Utilization of the LEO high spectral resolution rendering of moisture vertical and horizontal distributions needs to be encouraged. Recommendation: Regional forecasts and nowcasts necessary for a Weather Ready Nation will have to make better use of the information content from AIRS, CrIS, and IASI data; GPS data should also be included. Between LEO sounding coverage, GOES-R data should be used to monitor temporal profile (atmospheric stability, etc) changes. Recommendation: To pursue the missing continuous viewing essential for capturing the rapidly changing conditions that go with severe weather, transition to a GEO high spectral resolution IR sounder should receive higher priority within NOAA. A Transition Plan and Transition Survey should be completed as soon as possible.



On 11 September, I participated in a Cal/Val telecom that was responding to a request for more information on the GOES-R pre- and post-launch plans for instrument characterization and calibration. The briefing by Robert Iacovazzi was thorough and reassuring.

### ***NOAA Science Advisory Board Satellite Task Force***

On 19 – 20 June, I participated in the meeting of the NOAA Science Advisory Board Satellite Task Force (SATTF) in Silver Spring MD. The SATTF is evaluating the NESDIS future plans and advising the SAB on their satellite service re-planning. The goal of the re-plan is to rein in rising costs, maintain scope, but accept increased risk if necessary. It is apparent to the SATTF that NESDIS is making strong efforts to re-plan; to date they have:

- developed an evaluation tool for comparing user requirements to satellite capabilities;
- given consideration to reduced payloads flying in formation;
- examined small satellite approaches;
- begun a study of an enterprise ground system for sensors in leo, geo, and other orbits; and
- maintained strong links with international partners.

On 13-14 September, I participated in another meeting of the NOAA Science Advisory Board Satellite Task Force (SATTF) in Silver Spring MD. At this meeting a final report was drafted for presentation to the SAB in early November. Some of the major findings and observations of the SATTF include:

1. NOAA's budget for currently planned space systems appears to be unsustainable;
2. Today's fiscal environment could very well lead NOAA to increase risk or decrease scope while balancing satellite system cost, performance and schedule;
  - NOAA NESDIS leaders clearly stated prioritized programmatic criteria for establishing an alternative space-based architecture (in the order of cost, schedule and level of performance);
3. The constrained fiscal environment will require prioritization of threshold space-based observational requirements;
4. NOAA needs a total systems approach to satellite architecture development;
  - NOAA is in a position to undertake this as it now has sole responsibility for both JPSS and GOES;
5. NOAA needs to develop affordable, flexible and robust satellite architecture alternatives, using common measures of merit, to address the budget challenge;
  - Building alternative architectures is not easy and requires organizational commitment as well as budget and programmatic flexibility and stability;
  - NESDIS has developed options for future enterprise ground system architecture and alternative JPSS variants;
6. NOAA is to be commended for taking steps to address the need for a future satellite system architecture;
  - Significant challenges are inherent in developing satellite architectural alternatives;
  - Additional effort and continued commitment is required toward meeting that goal, building on the progress to date; and
7. NOAA is to be commended for establishing a process capable of prioritizing needs for space-based observations; however, the process is incomplete, as it cannot always be used to demonstrate impacts from the removal of capabilities.





### **Collaborations with EUMETSAT**

I am co-authoring with Dr. Jo Schmetz an article for publication titled “Evolving Satellite Remote Sensing Capabilities and Meeting User Requirements – A Look at the Evolution of Meteorological Satellites.” A new version was drafted in May 2012 and further work is planned for early 2013.

I coordinated scientists at SSEC/CIMSS in adapting and testing the Smith-Weisz clear and cloudy dual regression sounding algorithm for use with AIRS, IASI, and CrIS. The IASI processing package was successfully tested by Dr. Klaes; after his approval it has been added to the Community Satellite Processing Package being maintained at SSEC/CIMSS. It is now possible to produce soundings from all three instruments with the same algorithm; differences are indicative of diurnal signal or instrument information content.

### **Producing Updated Version of Sat Met Notes**

In preparation for several remote sensing “boot camps” scheduled for March and July 2013, I have prepared an updated version of the textbook “Remote Sensing Applications with Meteorological Satellites.” It is available at <ftp://ftp.ssec.wisc.edu/pub/menzel/AppMetSat12.pdf>.

## **14. CIMSS Studies on Advanced IR Sounder for Geostationary Orbit**

**CIMSS Task Leader: Jun Li**

**CIMSS Support Scientists: Zhenglong Li, Jason Otkin, Agnes Lim Huei Ni, Yue Li**

**NOAA Collaborators: Tim Schmit, Robert Atlas**

**NOAA Long Term Goals**

- Climate Adaptation and Mitigation
- Weather-Ready Nation

**NOAA Strategic Goals**

- Serve society’s needs for weather and water
- Support the nation’s commerce with information for safe, efficient and environmentally sound transportation
- Provide critical support for the NOAA mission

**CIMSS Research Themes**

- Satellite Meteorology Research and Applications
- Environmental Models and Data Assimilation

### **Proposed Work**

This proposal is for the University of Wisconsin-Madison (UW-Madison) Cooperative Institute for Meteorological Satellite Studies (CIMSS) to study the unique value of a geostationary advanced infrared (IR) sounder for severe weather warning and short-range forecasting over land, as well as to develop methodologies for simulating the geostationary advanced IR sounder data for typical weather events such as hurricanes for regional OSSE, along with the application of the geostationary advanced IR sounder data in pre-convection environment.

### **Summary of Accomplishments and Findings**

As part of the regional OSSE project, CIMSS is responsible for generating the simulated radiance/brightness temperature (T<sub>b</sub>) from future instruments. As a representative of future instrument, an AIRS onboard geostationary satellite is assumed and used. Major achievements and findings include:



1. Software in Fortran 90 is developed to simulate AIRS Tb (brightness temperature) spectrum in geostationary orbit. The software has the following capability:
  - read WRF forecast in netCDF format, and write the simulated Tb in netCDF;
  - can change the location of the AIRS-Geo. The results shown below assume the location at -50 degree in longitude;
  - can switch to other radiative transfer models (RTMs) if needed. SARTA is used as default; and
  - can switch to other instruments such as IASI and CrIS if needed;
2. The software is applied to the four WRF forecast output files produced by NOAA AOML. In the radiance simulation, clouds are well identified with phase correctly determined after comparison with WRF forecast hydrometer profiles. The simulated radiances appear realistic in both clear and cloudy regions;
3. The temporal variation of the simulated Tb agrees with observations (GOES Imager) very well, indicating radiances in both clear and cloudy skies are well simulated;
4. The software is ready for processing large amount of data; and
5. It appears that there is a possible bug in the WRF forecast. There are some stationary rain features in the QRAIN, which does not move temporally.

Below are more details on CIMSS progress.

### ***The WRF Data Used for Natural Run***

Four WRF forecast files were provided by the Atlantic Oceanographic and Meteorological Laboratory (AOML):

wrfout\_d01\_2005-08-01\_00:30:00

wrfout\_d03\_2005-08-01\_00:30:00

wrfout\_d02\_2005-08-01\_00:30:00

wrfout\_d04\_2005-08-01\_00:06:00

Figure 14.1 shows the domain of each file; four domains (from large to small) are shown.

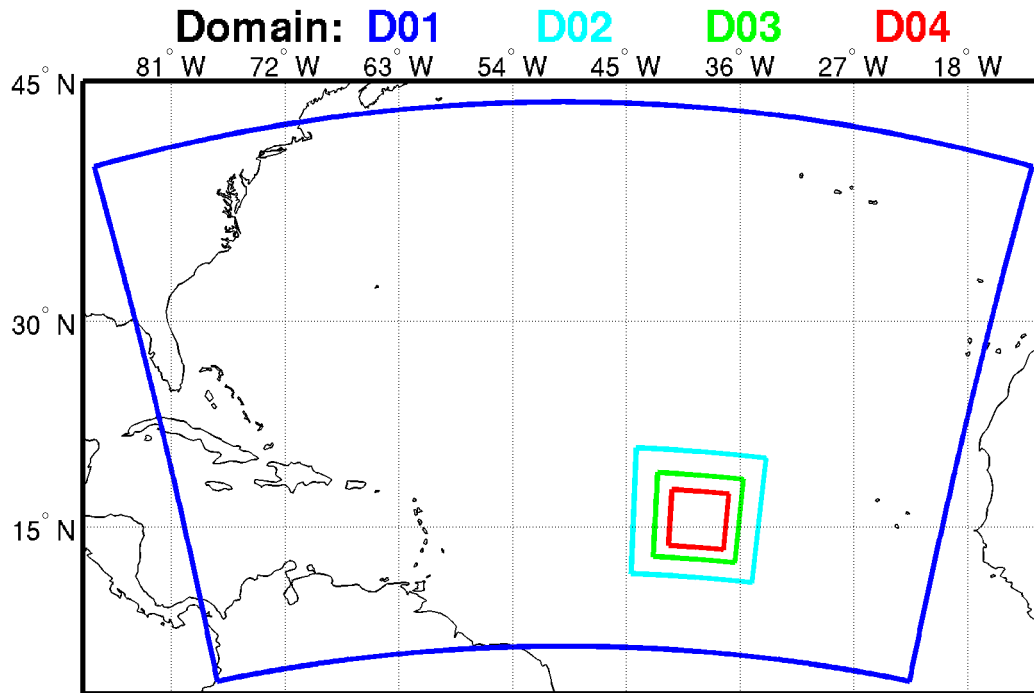
Among all the parameters provided, Table 14.1 shows those used in the radiative transfer calculation. Additional ancillary data include climatological ozone profile, surface emissivity (0.99 for all channels and all pixels over ocean), geostationary satellite position (longitude of -50 degree), latitude and longitude. All profiles are linearly interpolated from 62 WRF levels to 101 radiative transfer model levels. Levels above the model top are filled with climatological temperature and water vapor profiles. Use of climatological profiles in those upper levels has very minor impacts on the radiative transfer calculation.

### ***Preparation for RT Modeling***

The radiative transfer model (RTM) requires four parameters about clouds in order to perform the cloudy RT calculation: the effective cloud particle diameter, cloud optical thickness (COT), effective cloud top pressure (CTP) and cloud phase (Wei et al., 2004). Because infrared radiation has limited penetration capability through clouds, the calculation of cloud top and cloud particle are estimated using transmittance variation as weight. For clouds with optical thickness larger than 2, the cloud bottom (the lowest level in clouds seen by the instrument) is assumed at COT = 2. If only liquid (or ice) clouds are presented, the cloud phase is determined accordingly. If both liquid and ice clouds are presented, the cloud phase is determined by the phase of the cloud on the top. All clouds with CTP larger than 600 hPa are considered liquid water clouds. And all clouds with CTP smaller than 400 hPa are considered ice water clouds. The diameters of cloud particles at each level are estimated based on the microphysics schemes. See (Otkin et al., 2009; Otkin and Greenwald 2008; Otkin et al., 2007) for more details. The optical thickness of each hydrometer



profile is calculated using the same method used by Otkin et al., 2009. A pixel is classified as cloudy if the integrated optical thickness of all hydrometers is larger than 0.01. Otherwise, it is considered clear.



**Figure 14.1.** The domain of the four WRF forecast output.

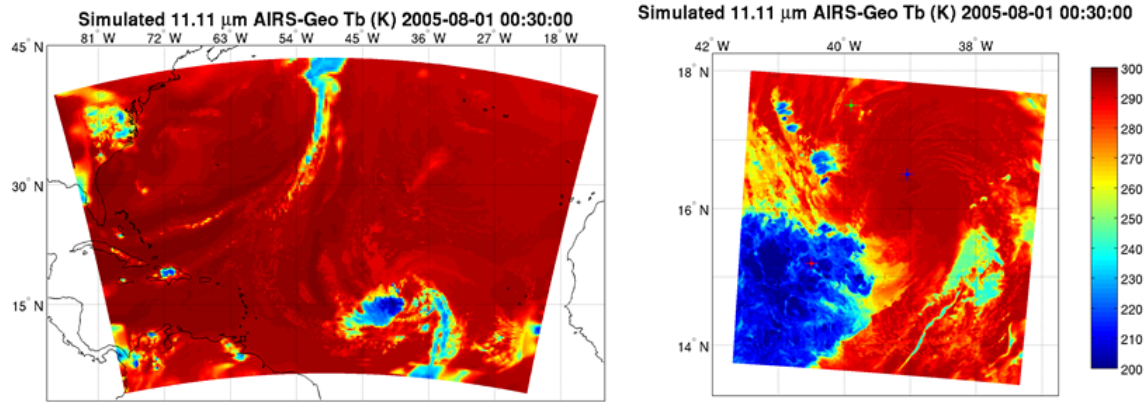
**Table 14.1.** The parameters from WRF forecast used in the radiative transfer calculation.

Clear parameters	Cloud parameters
Surface skin temperature (K)	Cloud water mixing ratio (kg/kg)
Temperature profile (K)	Rain water mixing ratio (kg/kg)
Water vapor mixing ratio profile (kg/kg)	Ice mixing ratio (kg/kg)
Surface pressure (Pa)	Graupel mixing ratio (kg/kg)
	Snow mixing ratio (kg/kg)

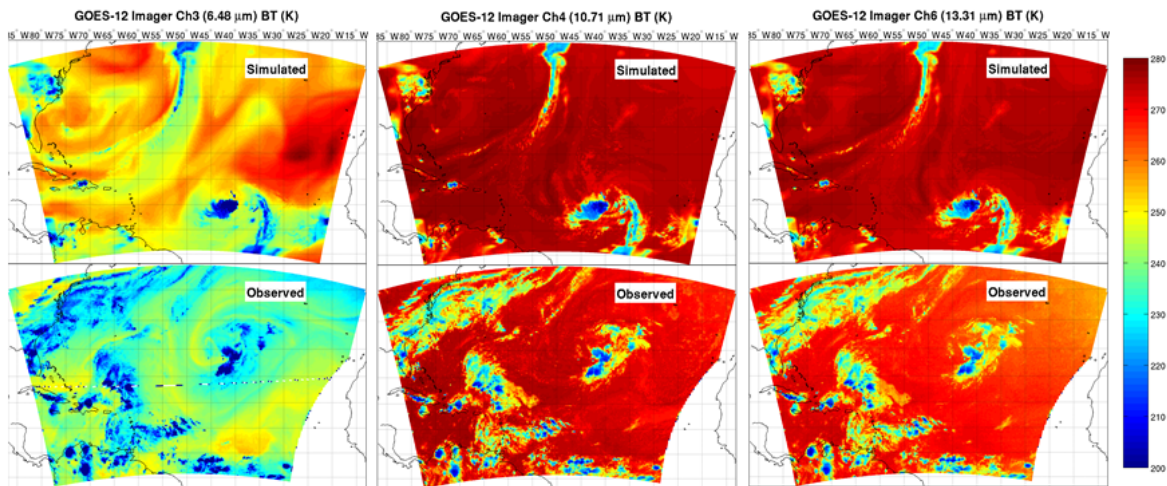
The local zenith of each pixel is calculated by assuming the satellite is in the geostationary orbit with a longitude of -50 degree. However, since SARTA does not support the satellite height of 35800 km, it is still assumed at an altitude of 705 km. It is important to point out that the setting in assimilation should be exactly same as here in the simulation.

### **Validation of Simulated Radiances**

The validation of the simulated Geo AIRS brightness temperature ( $T_b$ ) is very difficult because the WRF forecast is initialized using ECMWF nature run, which has been run for more than 2000 hours. As a result, it is reasonable to see the WRF forecast not close to reality (actual air mass). An example is given in Figure 14.2. The simulated Geo AIRS  $T_b$  are convolved with GOES-12 Imager spectral response function (SRF) to generate the simulated GOES-12 Imager  $T_b$ . For the three infrared channels, the simulation from natural run is totally different from the real observations (see Figure 14.3).



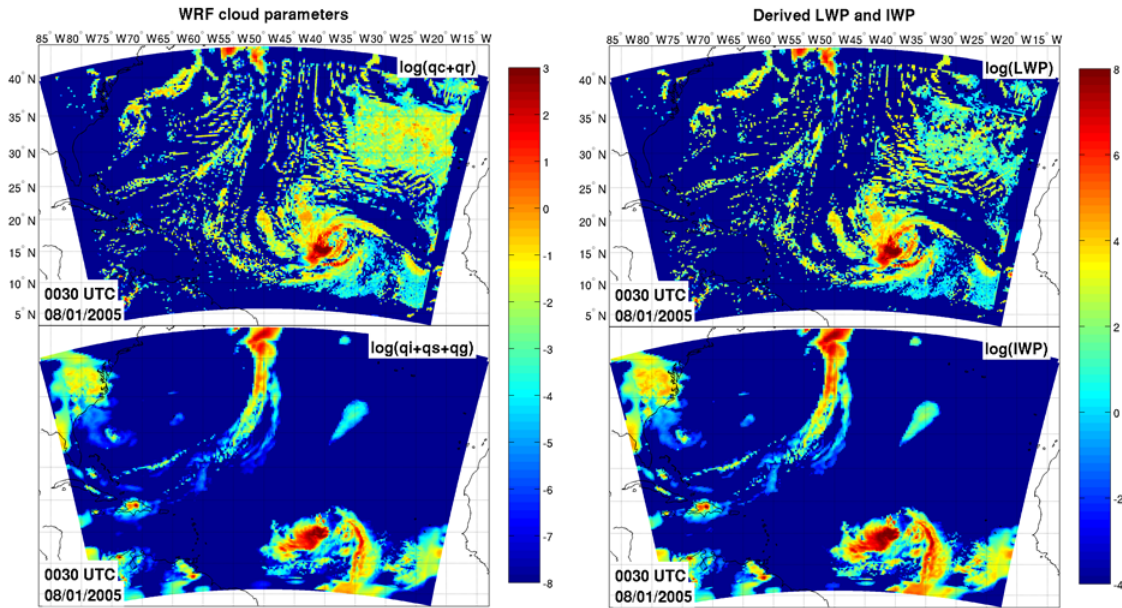
**Figure 14.2.** The simulated AIRS-Geo Tb at 11.11 micron at 0030 UTC on August 1 2005 for area D01 (left) and D04 (right).



**Figure 14.3.** Comparison of simulated GOES-12 Imager Tb with real observations. The upper panels represent the simulation, and the lower panels represent observations. Each column represents one GOES-12 Imager channel.

The simulated Geo AIRS Tb is validated in two steps. In the first step, the focus is on the software's capability to identify clouds. Figure 14.4 shows the results, the left panels are the vertical sum of hydrometer profiles for liquid cloud (top panel for water clouds and rain clouds), and for ice cloud (bottom panel for ice clouds, graupel clouds and snow clouds). These results are directly from the WRF forecast files. The right panels are derived liquid water path and ice water path from the software. The high similarity between the left and right panels in Figure 14.4 indicates the software is able to identify the cloud location, types and optical thickness reasonably well.

In the next step, we examine the software's capability on simulating the radiances. As mentioned before, because the WRF model is looking at air mass different from reality, it is impossible to validate the simulated radiance using real observations. So the validation focuses on if the temporal variation of the simulated radiance is similar to the reality. If the temporal variation of the WRF forecast is not realistic, or if the simulated radiance is not realistic, it is unlikely the temporal variation of the simulated radiances will be in a similar pattern as the real observations.

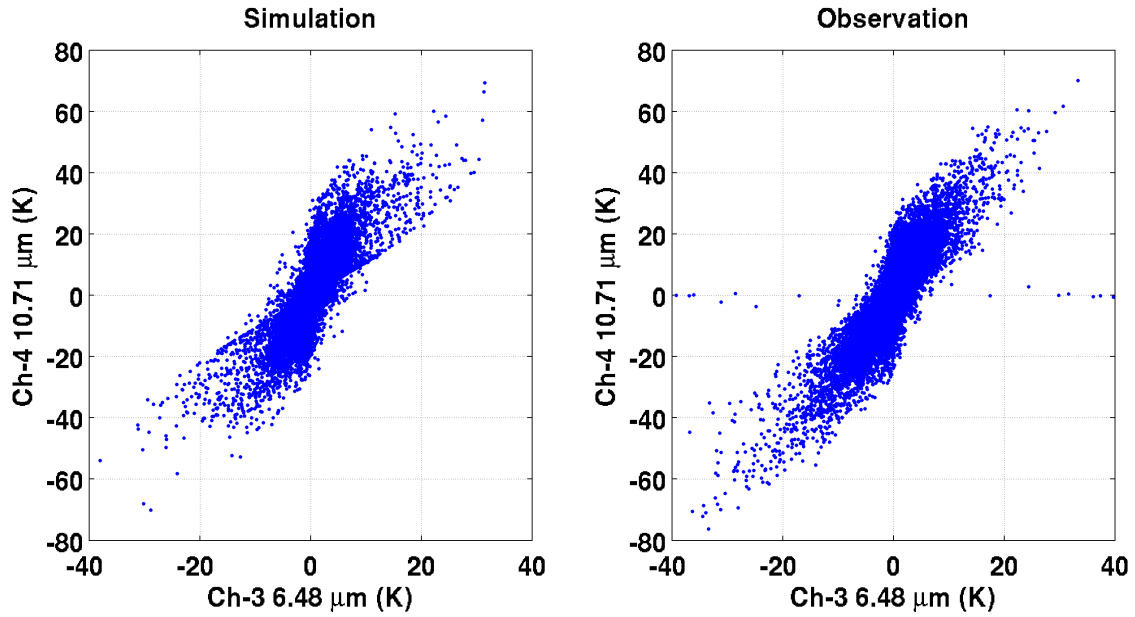


**Figure 14.4.** Comparison of WRF forecast (left) with the derived liquid water path (upper right) and ice water path (lower right).

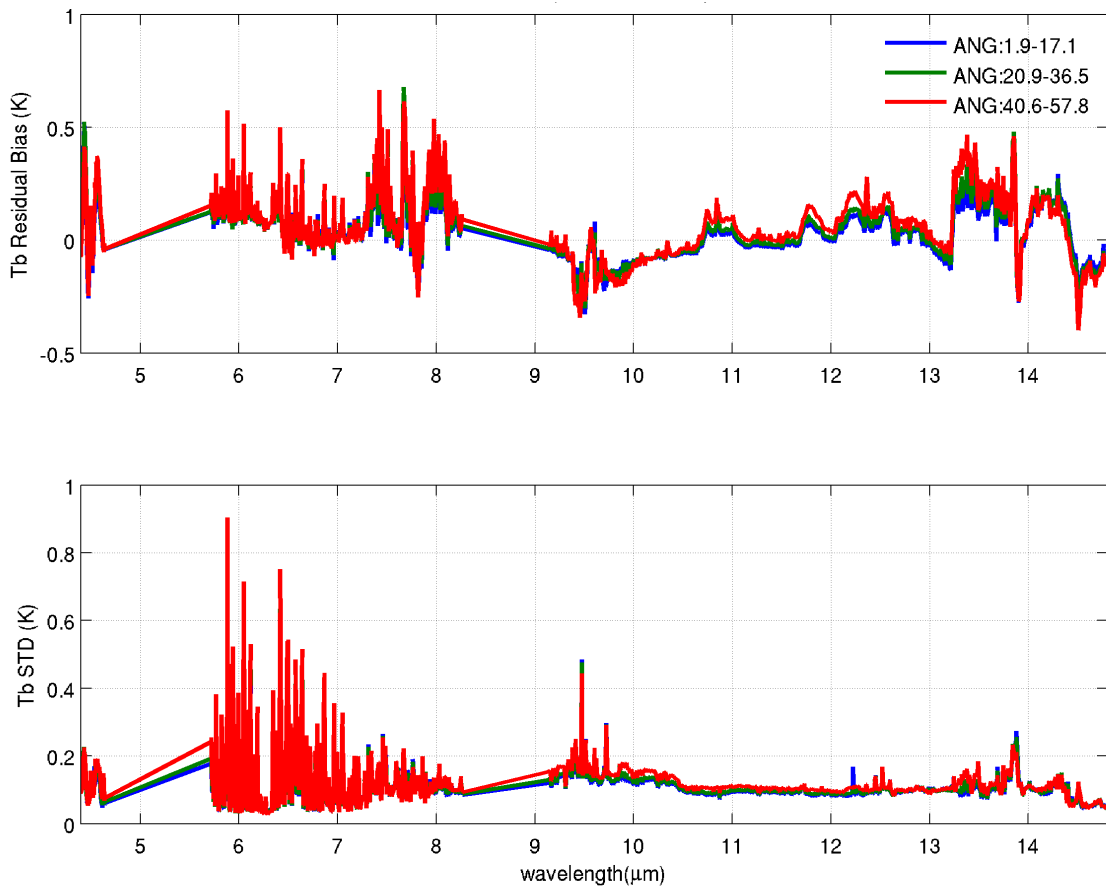
### **Comparison of RT models**

Figure 14.5 shows the comparison of the temporal variations between the observations and the simulations for GOES-12 Imager channel 3 (6.48 micron) and channel 4 (10.71 micron). The temporal variation is defined as the  $T_{b_{t_2}} - T_{b_{t_1}}$ , where  $t_2 - t_1$  is 30 minutes for GOES-12 Imager. The simulated AIRS radiances are convolved with GOES-12 Imager spectral response function (SRF) to generate the simulated GOES-12 Imager radiances. The similarity between the left and the right panels indicates that the simulated radiances capture the real temporal variation reasonably well. Comparison of channel 3 (6.48 micron) and channel 6 (13.31 micron) also shows similar agreement.

All the results presented are generated using SARTA V1.07 (Strow et al., 2003) plus the cloudy model (Wei et al., 2004). Figure 14.6 shows the clear sky radiative transfer model (RTM) comparison between SARTA and CRTM, UW SeeBor database (Seemann et al., 2003, 2008) are used in the radiance calculations with the same inputs of profiles, surface parameters, and geometry. It shows that the CRTM (version of 2.0.5 with ODPS, see Chen et al., 2010, 2012) agrees with SARTA reasonably well. The bias shows some spectral variations, especially in the longwave CO<sub>2</sub> region ( $\geq 13$  microns). However, most of the bias is within  $\pm 0.3$  K. The water vapor and CO<sub>2</sub> channels have slightly larger bias, but in general within  $\pm 0.5$  K. The standard deviation (StdDev) shows very good agreement between the SARTA and the CRTM. There is no obvious spectral dependency shown, except on some of the absorption lines (water vapor, ozone and CO<sub>2</sub>). These model comparisons provide useful information for assimilating the simulated radiances. The two RTMs agree reasonable well but has some differences, which enable using one RTM in simulation and another in assimilation in regional OSSE.



**Figure 14.5.** The temporal variation of GOES-12 Imager channel 3 and 4 from the simulation (left) and the observation (right).



**Figure 14.6.** The clear sky radiative transfer model (RTM) comparison (bias in upper panel, StdDev in lower panel) between SARTA and CRTM with different satellite viewing angle zone (1.9 – 17.1; 20.9 – 36.5 and 40.6 – 57.8 degree).



## Publications and Conference Reports

Li, J., 2012: Assimilation of satellite data in regional NWP - progress and challenges, invited talk at the NSF sponsored Earth Cube Workshop – Shaping the Development of EarthCube to Enable Advances in Data Assimilation and Ensemble Prediction, 17 – 18 December 2012, Boulder, Colorado.

Li, J., T. J. Schmit, R. Atlas, R. Heymann, Z. Li, J. Otkin, W. Bai, T. Schaack, and B. Pierce, 2012: GEO advanced IR radiance simulation and validation for R-OSSE, presentation at AGU Fall Meeting, San Francisco, CA, 03 – 07 December 2012.

## References

Otkin, J. A., T. J. Greenwald, J. Sieglaff, and H.-L. Huang, 2009: Validation of a large-scale simulated brightness temperature dataset using SEVIRI satellite observations. *J. Appl. Meteor. Climatol.*, **48**, 1613-1626.

Otkin, J. A., and T. J. Greenwald, 2008: Comparison of WRF model-simulated and MODIS-derived cloud data. *Mon. Wea. Rev.*, **136**, 1957-1970.

Otkin, J. A., D. J. Posselt, E. R. Olson, H.-L. Huang, J. E. Davies, J. Li, and C. S. Velden, 2007: Mesoscale numerical weather prediction models used in support of infrared hyperspectral measurements simulation and product algorithm development. *J. Atmospheric and Oceanic Tech.*, **24**, 585-601.

Seemann, S. W., J. Li, W. P. Menzel, and L. E. Gumley, 2003: Operational retrieval of atmospheric temperature, moisture, and ozone from MODIS infrared radiances. *J. Appl. Meteorol.*, **42**, 1072-1091, doi:10.1175/1520-0450(2003)042<1072:OROATM>2.0.CO;2.

Seemann, S. W., E. E. Borbas, R. O. Knuteson, G. R. Stephenson, and H.-L. Huang, 2008: Development of a global infrared land surface emissivity database for application to clear sky sounding retrievals from multi-spectral satellite radiance measurements. *J. Appl. Meteorol. Climatol.*, **47**, 108-203, doi:10.1175/2007JAMC1590.1.

Strow, L. L., S. E. Hannon, S. De Souza-Machado, H. E. Motteler, and D. Tobin, 2003: An overview of the AIRS radiative transfer model. *IEEE Trans. Geosci. Remote Sens.*, **41**, 303–313.

## 15. GOES-R Calibration/Validation Field Campaign Support

**CIMSS Task Leader: Wayne Feltz**

**CIMSS Support Scientists: Lee Cronce, Todd Schaak, Allen Lenzen, and Erik Olson**

**NOAA Collaborators: Brad Pierce, Andy Heidinger and Shobha Kondragunta**

### NOAA Long Term Goals

- Weather-Ready Nation

### NOAA Strategic Goals

- Serve society's needs for weather and water
- Support the nation's commerce with information for safe, efficient and environmentally sound transportation



## **CIMSS Research Themes**

- Satellite Meteorology Research and Applications
- Satellite Sensors and Techniques
- Education and Outreach

## **Proposed Work**

This task would support ground-based field experiment validation for GOES-R Cloud, Aerosol, Land and Sounding AWG team algorithm requirements and addresses the need for more extensive calibration and validation was just highlighted in GOES-R Algorithm Development Board's baseline and option 2 response documents under Finding #1: "Insufficient Validation : Reporting of measurement validation lacked completeness and was rarely independent." The proposal builds on the Ground-based Atmospheric Monitoring Instrument Suite (GAMIS) instrumentation currently operating at University of Wisconsin' Space Science and Engineering Building which offers an impressive set of remote sensing capabilities. We propose here to leverage GAMIS instrumentation by adding a CIMEL sun photometer to provide an Aerosol Robotic Network (AERONET) suite of capabilities and a GPS-MET receiver to provide integrated precipitable water information. The addition of these instruments will complement the SSEC rooftop instrument suite and will provide a continuous aerosol and water vapor monitoring capability. In addition, we propose to deploy a high-spectral resolution LIDAR (HSRL) and a high-spectral resolution measurement of solar irradiance from the CU/LASP (SSFR) during the NSF sponsored DC3 field campaign in spring 2012. This suite of ground-based instruments will provide state-of-the-art validation opportunities for GOES-R Aerosol, Cloud, Surface Radiation and Sounding algorithms applied to GOES-13 and MODIS.

## **Summary of Accomplishments and Findings**

This proposal focuses on validation of GOES-R Advanced Baseline Imager (ABI) aerosol, cloud, land and sounding retrievals using surface and airborne measurements during NSF and NASA sponsored field campaigns scheduled during 2012. The airborne and surface validation tools and procedures developed under this proposal will provide the foundation for post-launch ABI validation activities in 2015.

### ***Task 1: Ground-Based Measurements for GOES-R Aerosol, Cloud, Surface Radiation and Total Precipitable Water Validation***

During the first year of this project we have added a CIMEL sun photometer to the UW-Madison SSEC roof-top instrumentation suite and become a member of the Aerosol Robotic Network (AERONET) federation. The CIMEL Sunphotometer is installed on the roof of the Engineering Research Building on the University of Wisconsin-Madison (UW) campus on November 01, 2012 (Figure 15.1). The instrument is approximately 55 m off the surface. The instrument was leveled and aligned and the "AUTORUN" feature was started. Data were collected manually during the first 2 weeks of November and transferred manually to the Aeronet group using the K7 file transfer Web page. Automatic data collection began on November 26, 2012.

We also deployed a high-spectral resolution LIDAR (HSRL) to Norman, OK from May 10-July 10, 2012 for ground-based lidar measurements during the NSF Deep Convective Clouds and Chemistry (DC3) mission and a high-spectral resolution Solar Spectral Flux Radiometer (SSFR) measurement of solar irradiance was deployed at Boulder, CO through a sub-contract award to CU/LASP.





**Figure 15.1.** Photo of CIMEL Sun Photometer at UW-Madison Engineering Research Building, 1500 Engineering Drive Madison, WI 53706.

***Task 2: Validation of GOES-R Aerosol and Cloud Retrievals during the 2012 TORERO and DC3 Field Campaigns***

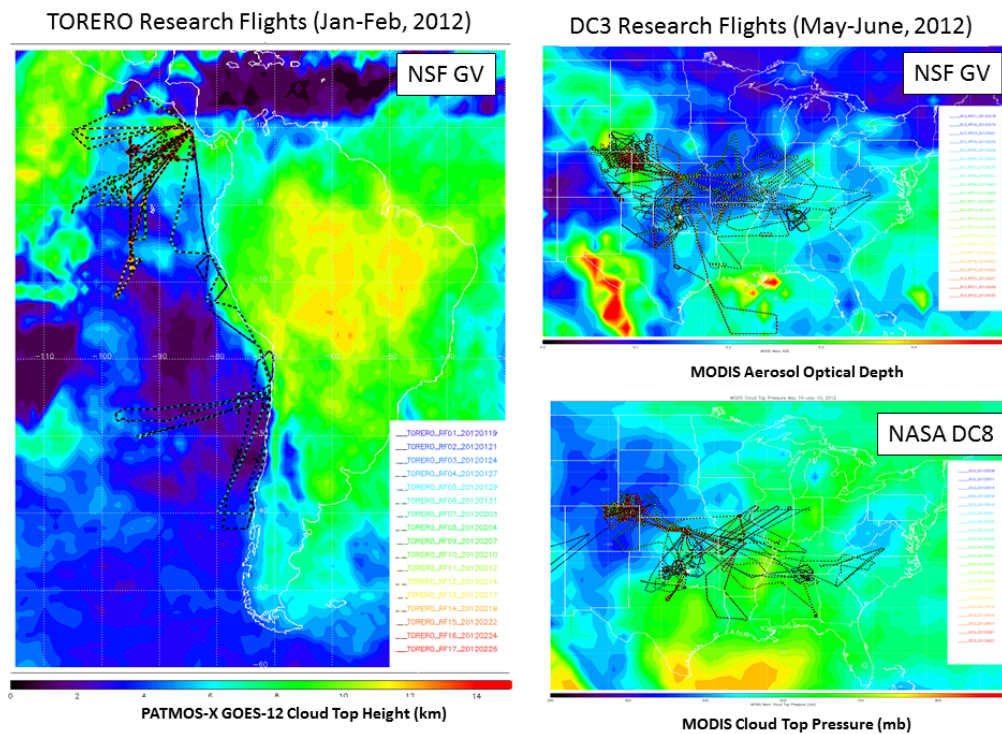
The first field campaign was the National Science Foundation (NSF) sponsored “Tropical Ocean Troposphere Exchange of Reactive Halogen Species and Oxygenated VOC” (TORERO) mission which sampled the Equatorial Pacific during January- February 2012. The second campaign was the joint NSF and NASA Deep Convective Clouds & Chemistry Experiment (DC3) campaign which sampled the central US campaign during May-June, 2012.

We participated in daily flight planning activities during both TORERO and DC3 by providing daily Real-time Air Quality Modeling System (RAQMS) Forecasting and AVHRR Pathfinders Atmospheres - Extended (PATMOS-X) cloud retrievals during both TORERO and DC3 missions. Active participation in the flight planning discussions and in-field analysis provides invaluable context for the airborne measurements and helps establish a meaningful collaboration between the GOES-R satellite community and airborne communities. Through collaboration with the TORERO and DC3 mission scientists as well as individual instrument PIs we had access to



preliminary airborne measurements for quick look comparisons. The airborne measurements include: direct measurements of aerosol and cloud extinction from High Spectral Resolution Lidar (HSRL) (Eloranta, 2005) during TORERO and Differential Absorption Lidar-High Spectral Resolution Lidar (DIAL-HSRL) (Hair et al., 2008) during DC3. Airborne hyperspectral cloud retrievals from the Solar Spectral Flux Radiometer (SSFR) (Pilewskie et al., 2003) and its follow-on the HIAPER Airborne Radiation Package (HARP) during TORERO and DC3; and Microwave Temperature Profiler (MTP) (Denning et al., 1989) retrievals during TORERO. We will use finalized airborne measurements for post mission validation activities during year 2 of this effort.

Figure 15.2 summarizes the airborne sampling by the NSF GV aircraft during TORERO and the combined NSF GV and NASA DC8 sampling during DC3. During TORERO the GV flew primarily out of Costa Rica and sampled outflow from maritime deep convection with additional survey flights along the South American Coast. Very little aerosol was observed during TORERO so our validation efforts will focus on cloud and temperature retrievals. During DC3 the GV and DC8 flew coordinated flights that targeted continental deep convection with the DC8 sampling low-level inflow and the GV sampling upper level outflow. Both aircraft sampled heavy aerosol loading due to extensive biomass burning that occurred over the western US and northern Mexico during DC3 so our validation efforts will focus on cloud, aerosol, and temperature retrievals.

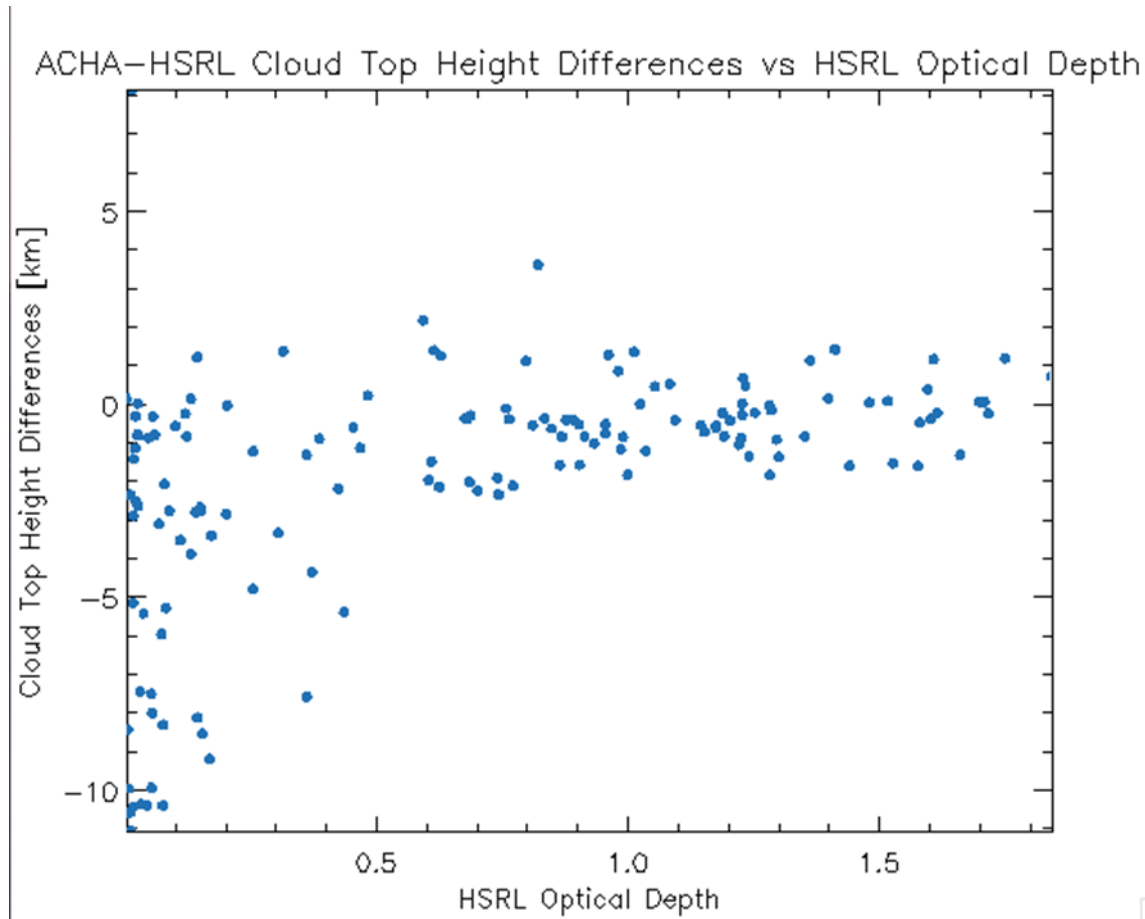


**Figure 15.2.** NSF GV and NASA DC8 flight tracks during TORERO (left) and DC3 (right) field campaigns. Mean January-February, 2012 PATMOS-X GOES-12 Cloud Top Height (km) retrievals are shown in the left panel. Mean May-June 2012 MODIS Aerosol Optical Depth and Cloud Top Pressure (mb) are shown in the upper and lower left, respectively.

The results of the NOAA AWG Cloud Height Algorithm (ACHA) run on GOES-13 were compared to the cloud heights from the University of Wisconsin High Spectral Resolution Lidar (HSRL). Results for June 2012 over the Norman, OK site are shown in Figure 15.3. The heights from the HSRL are determined by inspection of the extinction profiles. The truth height from



HSRL is computed by the height where the integrated extinction reaches unity or the physical midpoint of the cloud (whichever is higher). This “effective” cloud height from the HSRL should correspond to the height sensed by the infrared ACHA algorithm. The results indicate good performance by ACHA for optical depths greater than 0.5. This performance is within the specification placed on the GOES-R algorithm.



**Figure 15.3.** Variation of cloud top height difference (ACHA – HSRL) for June 2012 over the Norman, OK site. ACHA is the NOAA AWG Cloud Height Algorithm developed for GOES-R but modified for the spectral content of the current GOES Imagers.

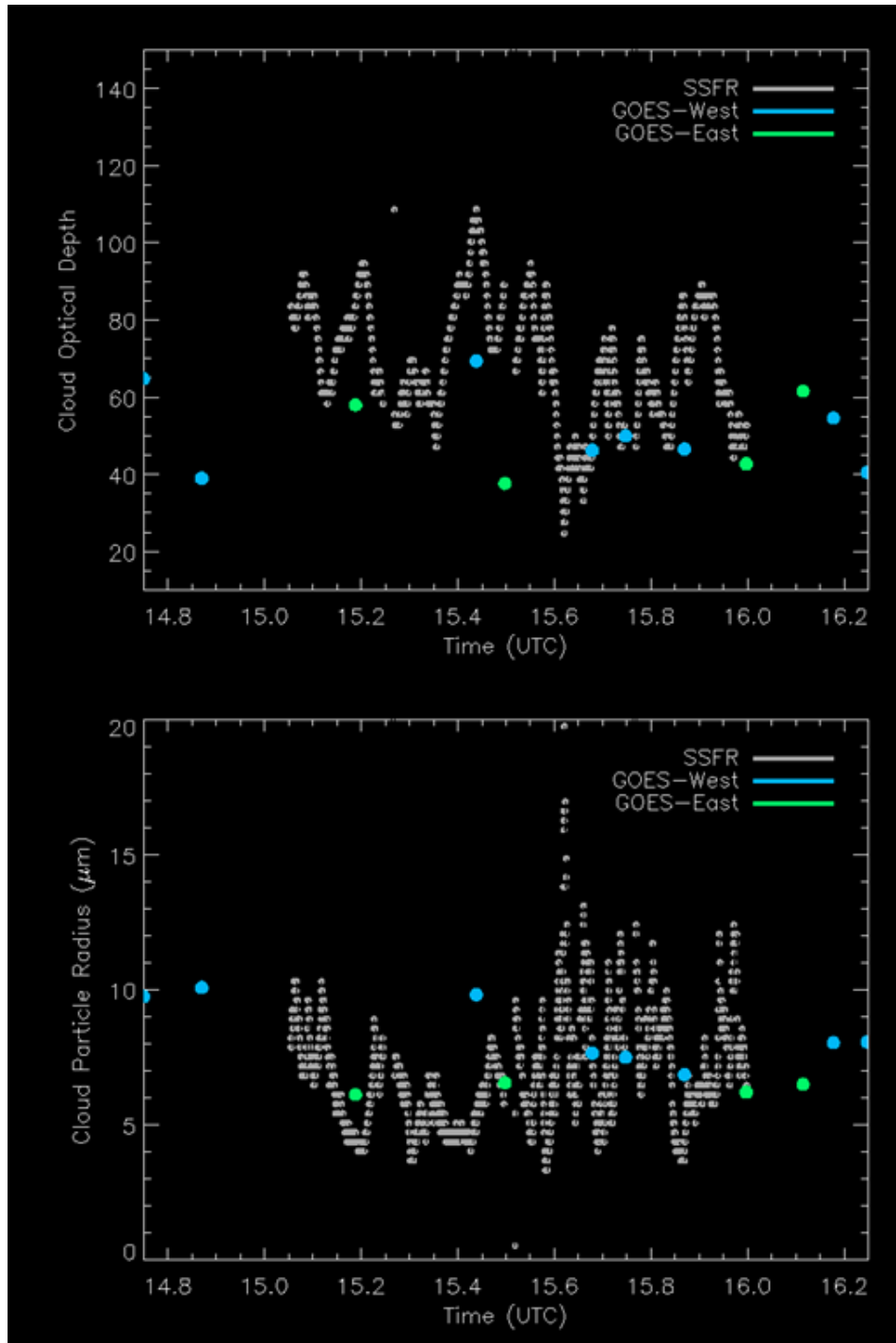
The University of Colorado LASP Solar Spectral Flux Radiometer (SSFR) group (Sebastian Schmidt, Lead) deployed the SSFR at Boulder, CO during DC3. SSFR provides multi-spectral retrievals of cloud optical thickness, effective radius, liquid/ice water path, as well as aerosol single scattering albedo and asymmetry parameter (with HSRL). The instrument is calibrated using a NIST-traceable lamp and has a radiometric accuracy of 3-5% and a precision of 0.5%. GOES PATMOS-X cloud microphysical retrieval validation studies using the Boulder SSFR measurements allow us to demonstrate the use of SSFR measurements for GOES-R ABI cloud validation. Cloud optical thickness and effective radius is derived from zenith-viewing spectral transmitted radiance using the spectral slope of the transmitted radiance between 1565 nm and 1634 nm, normalized to its value at 1565 nm and the transmittance at 515 nm (McBride et al., 2011). Normalizing the near-infrared transmittance by its value at 1565 nm before calculating the spectral slope reduces the dependence of the retrieval on spectrally correlated errors, such as radiometric uncertainty.



Figure 15.4 shows a comparison of SSFR retrievals from the ground-based installation at Boulder to those from GOES for May 25, 2012. GOES data were processed through GOES-R AWG Algorithms. Since the SSFR retrieval uses transmission viewed from below, it should be able to retrieve higher (and more accurate) optical depths for thick clouds. This appears to be the case here (optical depth > 60). Also, we expect SSFR particle radii to be generally less than those from GOES and this also appears to be true. GOES-R's higher temporal and spatial resolution should increase the accuracy of these comparisons.

## References

- Coddington, O., K. S. Schmidt, and P. Pilewskie (in progress): Characterization of a new transmittance-based cloud retrieval for radiance and irradiance measurements.
- Denning, R. F., S. L. Guidero, G. S. Parks, and B. L. Gary, 1989: Instrument description of the airborne microwave temperature profiler, *J. Geophys. Res.*, **94** (D14), 16,757–16,765, doi:10.1029/JD094iD14.
- Eloranta, E. W., 2005: "High spectral resolution lidar," in *Lidar: Range-Resolved Optical Remote Sensing of the Atmosphere*, K. Weitkamp, Ed. New York: Springer-Verlag, pp. 143–163, 2005.
- Hair, J. W., C. A. Hostetler, A. L. Cook, D. B. Harper, R. A. Ferrare, T. L. Mack, W. Welch, L. R., Izquierdo, F. E. Hovis, 2008: Airborne High Spectral Resolution Lidar for Profiling Aerosol Optical Properties. *Applied Optics*, **47**, doi: 10.1364/AO.47.00673.
- McBride, P. J., K. S. Schmidt, P. Pilewskie, A. S. Kittelman, and D. E. Wolfe, 2011: A spectral method for retrieving cloud optical thickness and effective radius from surface-based transmittance measurements. *Atmos. Chem. Phys.*, **11** (14), 7235-7252, doi:10.5194/acp-11-7235-2011.



**Figure 15.4.** Validation of GOES-R AWG cloud Optical Thickness (COT) and Cloud Particle Radius (Reff) retrievals using GOES-West (blue) and GOES-East (green) observations and SSFR retrievals (white) on May 25, 2012 at Boulder, CO.



## 16. SSEC/CIMSS Cloud Research in Support of the Suomi NPP and JPSS Programs

### 16.1. VIIRS Cloud Mask Validation and Tool Development

**CIMSS Task Leaders: Denis Botambekov**

**CIMSS Support Scientists: Rich Frey, Christine Molling**

**NOAA Collaborator: Andrew Heidinger**

#### **NOAA Long Term Goals**

- Climate Adaptation and Mitigation
- Weather-Ready Nation

#### **NOAA Strategic Goals**

- Serve society's needs for weather and water
- Understand climate variability and change to enhance society's ability to plan and respond
- Provide critical support for the NOAA mission

#### **CIMSS Research Themes**

- Satellite Meteorology Research and Applications
- Satellite Sensors and Techniques

### **Proposed Work**

#### ***Project Description***

This project supports the JPSS VIIRS Cloud Mask Cal/Val Team. The goal of this effort is to use our previously developed tools and tune the cloud mask. NPP/VIIRS was launched in November 2011. This work is coordinated with other members at other institutes.

We intend to leverage our efforts within the existing NPP PEATE located at the University of Wisconsin. Through this project, we intend to continue to interact with our NGST colleagues (Keith Hutchison and Eric Wong) and the Air Force Weather Agency (AFWA) in Omaha, Nebraska (Tom Kopp). This project will also aim to discover bugs and potential fixes in the VIIRS Cloud Mask (VCM).

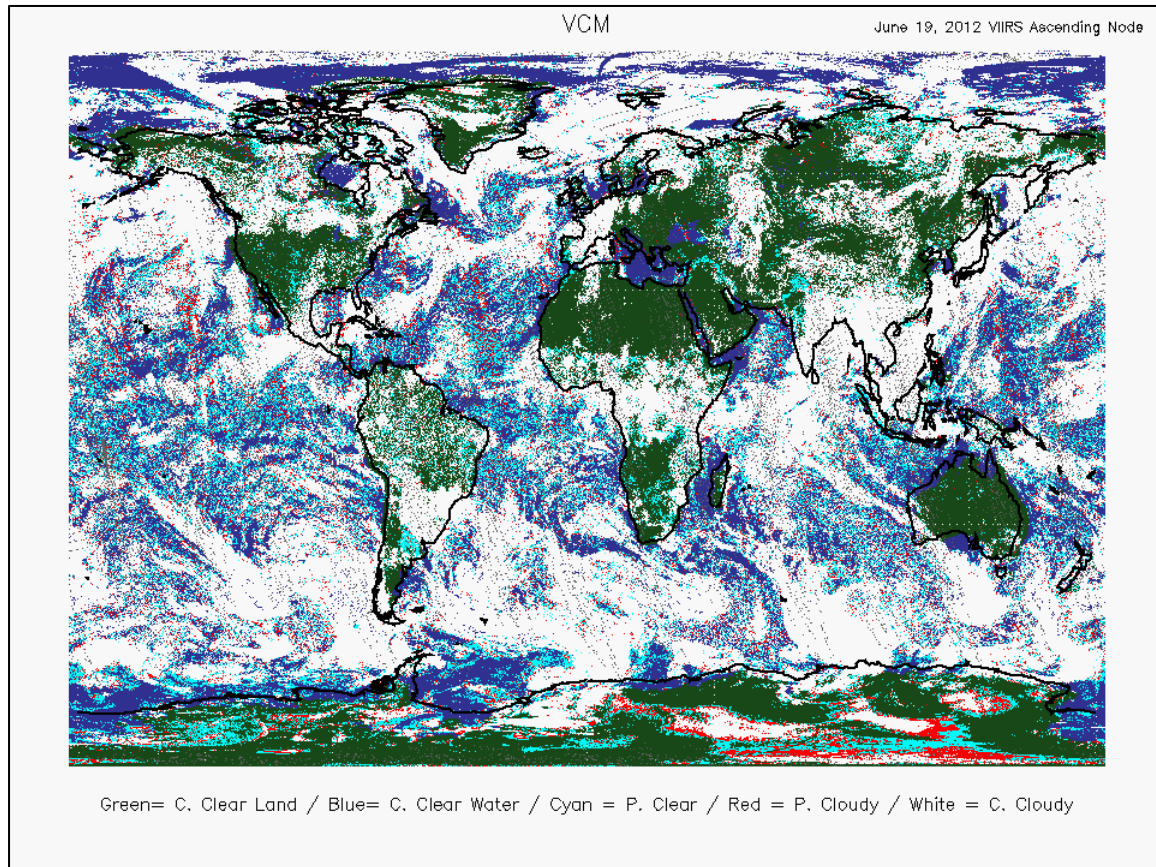
#### ***Task List***

- *Validation Tool Development*  
The cloud mask team is developing the tools to provide global validation of the VCM results. These tools complement the more detail tools developed for small individual granules.
- *NOAA/NASA Cloud Mask Comparison*  
The cloud mask team at CIMSS has developed tools to compare the cloud masks it develops for NASA and NOAA. These are run at the SSEC/CIMSS in Madison, Wisconsin (UW-Madison). They are designed to develop and analyze match-ups between the VCM, the MODIS cloud mask, and potentially other cloud mask algorithms.
- *NOAA Match-ups with CALIOP*  
CIMSS has also developed tools to compare CALIPSO LIDAR cloud detection results. This tool now runs at the SSEC/CIMSS in Madison, Wisconsin (UW-Madison). The tool is actually designed to analyze match-ups between CALIOP and any available cloud mask and can be used to identify large scale errors and can tie them to specific cloud characteristics (i.e., cloud height and emissivity).



## Summary of Accomplishments and Findings

Developed tools are used to plot global composites of VCM (Figure 16.1.1), validate them with the other cloud mask algorithm products (NOAA PATMOS-x, MODIS C5 and C6, etc.), analyze the quality of the clear radiances, and compare the performance of the VCM over all regions. We use these tools to identify large scale errors and differences between the VIIRS and MODIS cloud masks. These tools are capable of processing large amounts of data. We operate these tools periodically to track the performance changes of the VCM as it is tuned and refined.



**Figure 16.1.1.** VCM performance on June 19, 2012 ascending node (day time).

Developed CALIPSO – VIIRS match-ups collocation tools are used to generate many days of results and to also track changes in performance as the VCM is tuned. The tools allow making a statistical comparison with the other cloud mask products (Table 16.1.1).

The new thresholds for existing VCM tests (M1, M5, M7 Reflectance test, etc.) were found by using our global validation tools, which led to improvement of the performance of these tests and the algorithm in general. This work is done in a close collaboration with the other members of VCM Cal/Val team.



**Table 16.1.1.** Statistical Cloud Mask Algorithms comparison, based on CALIPSO – VIIRS/AQUA-MODIS collocation data from 11/10/2012 and 11/29/2012 over whole globe day and night.

Cloud Mask Algorithm	Sample Size	Cloud fraction				Probability of		
		Active	Passive	Pr. Clear	Pr. Cloudy	Detection	False D.	Leakage
VCM	582257	0.733	0.655	0.073	0.030	0.878	0.022	0.100
NOAA PATMOS-x VIIRS	582257	0.733	0.705	0.054	0.056	0.921	0.027	0.051
NOAA PATMOS-x MODIS	425370	0.749	0.712	0.066	0.059	0.937	0.013	0.050
MODIS C6	425370	0.749	0.733	0.056	0.048	0.930	0.027	0.043

## 16.2. VIIRS Cloud Mask Tuning and Software Support

**CIMSS Task Leader: Richard Frey**

**CIMSS Support Scientist: Denis Botambekov**

**NOAA Collaborator: Andrew Heidinger**

### NOAA Long Term Goals

- Climate Adaptation and Mitigation
- Weather-Ready Nation

### NOAA Strategic Goals

- Serve society's needs for weather and water
- Understand climate variability and change to enhance society's ability to plan and respond
- Provide critical support for the NOAA mission

### CIMSS Research Themes

- Satellite Meteorology Research and Applications
- Satellite Sensors and Techniques

### Proposed Work

This project supports the JPSS VIIRS Cloud Mask Cal/Val Team. The goal of this year's effort is to use our previously developed tools and tune the cloud mask. NPP/VIIRS was launched in November 2011. Our plan is to tune the VIIRS Cloud Mask (VCM) during in the spring of 2012. This work is coordinated with other member at other institutes. We intend to leverage our efforts within the existing NPP PEATE located at the University of Wisconsin. Through this project, we intend to continue to interact with our NGST colleagues (Keith Hutchison and Eric Wong) and the Air Force Weather Agency (AFWA) in Omaha, Nebraska (Tom Kopp). This project will also aim to discover bugs and potential fixes in the VCM.

### Summary of Accomplishments and Findings

Initial VCM cloud test threshold tuning was completed in April, 2012 and the new thresholds implemented on May 1, 2012. Pre-launch values were updated to optimize cloudy vs. clear-sky discrimination using input VIIRS calibrated reflectance and infrared brightness temperatures measured from space. Figure 16.2.1 shows zonal distributions of the four VCM output clear-sky confidence categories using pre- and post-launch thresholds. As clear vs. cloudy thresholds were adjusted to match measured on-orbit values, the numbers of probably clear and probably cloudy results declined as expected.

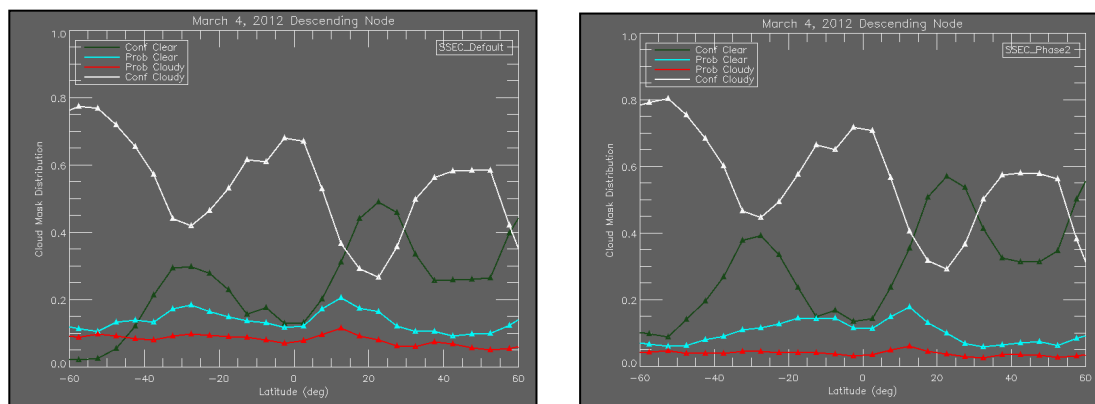




Additional M1 (0.412 mm) and M5 (0.672 mm) reflectance thresholds were developed for background top of canopy NDVIs of 0.0-0.3. Many semi or seasonally arid regions are not identified as “deserts” in the static ancillary surface type data; hence, either M1 (normally used as a daytime desert test) or M5 tests are used in these cases, determined by a threshold NDVI of 0.2. The thresholds are functions of NDVI and scattering angle.

Scattering angle dependent M7 (0.865 mm) cloud test thresholds were developed for daytime water surfaces, replacing the original static values. While the new thresholds are very effective for most ocean areas, problems have been identified for regions impacted by sun-glint. Thresholds for these areas will be re-derived.

The nighttime land M12-M16 (3.7-12.0 mm) brightness temperature difference (BTD) and nighttime ocean M15-M12 (10.8-3.7 mm) BTD test thresholds were further optimized after the initial tuning. The M12-M16 test was significantly over-clouding in some tropical areas and the M15-M12 was tuned to detect more ocean stratus clouds.



**Figure 16.2.1.** Zonal distribution (percent) of VCM output clear-sky confidence categories for March 4, 2012 using pre-launch (left) and post-launch (right) cloud test thresholds. Confident clear and confident cloudy categories (green, white) show an increase while probably clear and probably cloudy results (cyan, red) show declines as thresholds were adjusted to on-orbit measured visible/NIR reflectances and IR brightness temperatures.

### 16.3. VIIRS Cloud Mask Validation using Surface Sites

**CIMSS Task Leader: Christine Molling**  
**CIMSS Support Scientist: Lisha Roubert**  
**NOAA Collaborator: Andrew Heidinger**  
**NOAA Long Term Goals**

- Climate Adaptation and Mitigation
- Weather-Ready Nation

#### **NOAA Strategic Goals**

- Serve society’s needs for weather and water
- Understand climate variability and change to enhance society’s ability to plan and respond



- Support the nation's commerce with information for safe, efficient and environmentally sound transportation
- Provide critical support for the NOAA mission

### **CIMSS Research Themes**

- Satellite Meteorology Research and Applications

### **Proposed Work**

This project supports the JPSS VIIRS Cloud Mask Cal/Val Team. The goal of this project is to develop the capability of using surface radiometers and other surface-based cloud fraction estimates to complement the other cloud mask validation work. The primary surface sites used in this task are those in the NOAA SURFRAD network. SURFRAD provides data from eight sites across the conterminous USA which span a wide range of surface conditions. Our plan is support the tuning of the VIIRS Cloud Mask (VCM) during in the spring of 2012. This work is coordinated with other members at other institutes.

### **Summary of Accomplishments and Findings**

Developed tools to compute statistics between the VCM and observations taken at ground level at seven SURFRAD sites (SGP not used). Statistics were computed using the 9 pixels closest to each site from the VCM. Confident Clear and Probably Clear were considered clear, and confident Cloudy and Probably Cloudy were considered Cloudy. From the 1/0 cloudy values the fraction of cloudiness was computed. For the SURFRAD stations, data were taken at the VIIRS scan time for each station.

Cloudiness statistics were calculated from two independent SURFRAD measurements. To determine cloudiness at the SURFRAD sites, the SURFRAD skin temperature was compared to that derived from VIIRS. VIIRS skin temperatures (which may be the surface or a cloud) colder than 2K compared to the SURFRAD skin temperature were considered to indicate a cloudy view. Cloud fractions greater than zero were considered cloudy. This method is used for all sun angles, including night. See Table 16.3.1 for results.

Cloud fraction from the VCM was also compared to Total Sky Imager (TSI) data at FPK, which is the only SURFRAD station which has a nearly complete record during 2012. Fractional cloudiness +/- 5min mean (opaque + thin cloud) was computed for solar zenith angles  $\leq 80^\circ$  (full daytime only). Probability of correct Detection (POD) was calculated only for clear (fraction cloudy  $\leq 0.2$ ) and cloudy (fraction cloudy  $\geq 0.8$ ) conditions. See Figure 16.3.1 for results.

Conclusions based on analyses include:

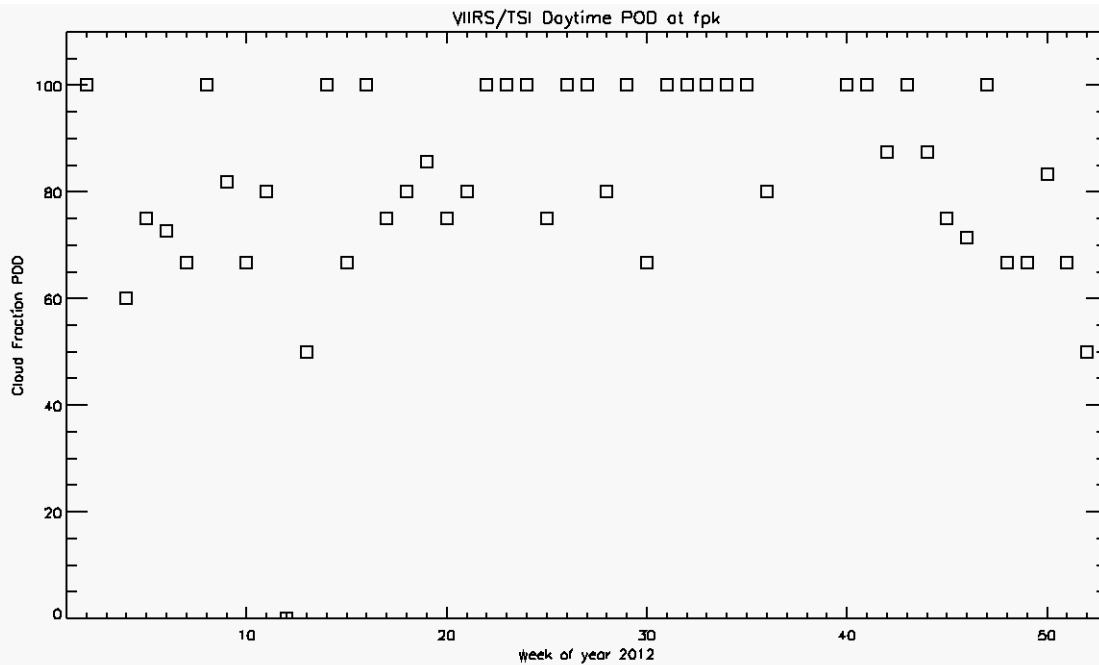
1. Seven sites are not enough to determine independently when the VCM algorithm changed (May and Oct 2012) and therefore not enough to fully evaluate the VCM. ISIS sites will be added in the future;
2. The mean probability of correct detection of the VCM based on skin temperature is 78% for all sun angles, sites and months;
3. The lowest POD based on skin temperature is at Desert Rock, NV (dra) at 62%. The highest POD is at Penn State, PA (psu) at 87%;
4. Changing the VCM clear sky definition to 0.2 and averaging +/- 5min of data at the SURFRAD sites changes the average POD to 83%, indicating temporal averaging may be beneficial in these comparisons; and
5. The probability of correct detection of the VCM as compared to TSI averaged 82% in 2012. TSI data will require a more in depth analysis, including parallax correction and a



varying spatial box average (function of cloud height) to achieve more trustworthy comparisons.

**Table 16.3.1.** Monthly probability of correct detection (%) of the VCM as compared to satellite-SURFRAD skin temperature difference. Average is 78%.

Month	bon	gwn	psu	sxf	dra	fpk	tbl	Avg
1	91	88	89	92	86	94	88	90
2	88	77	86	77	65	74	64	76
3	85	87	75	80	65	85	55	76
4	87	75	80	78	67	71	71	76
5	76	85	89	88	58	77	71	78
6	82	77	86	88	58	83	66	77
7	92	86	88	85	57	82	85	82
8	87	86	91	84	62	66	75	79
9	84	74	85	83	49	72	71	74
10	82	83	91	80	48	78	71	76
11	72	69	90	80	51	79	71	73
12	90	87	94	87	73	80	82	85
Avg	85	81	87	84	62	78	73	78



**Figure 16.3.1.** Weekly probability of correct detection of the VCM as compared to total sky imager data at Fort Peck, MT. Only clear and cloudy scenes are compared – partly cloudy scenes are omitted. Mean value is 82%.



## 16.4. SSEC/CIMSS Cloud Research in Support of the Suomi NPP and JPSS Programs: Cloud Properties Algorithm

**CIMSS Task Leader: Andi Walther**

**NOAA Collaborator: Andrew Heidinger**

### NOAA Long Term Goals

- Climate Adaptation and Mitigation
- Weather-Ready Nation

### NOAA Strategic Goals

- Serve society's needs for weather and water
- Understand climate variability and change to enhance society's ability to plan and respond
- Provide critical support for the NOAA mission

### CIMSS Research Themes

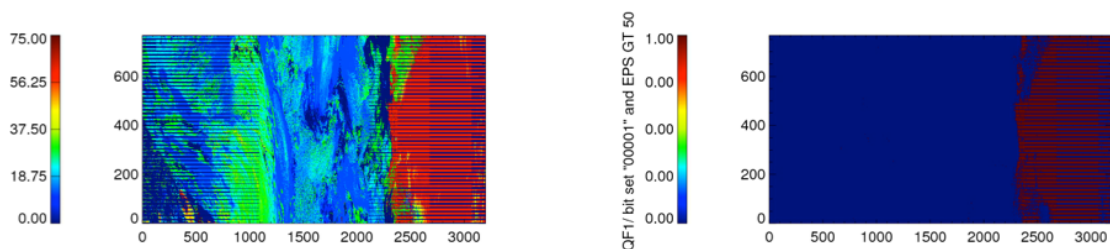
- Satellite Meteorology Research and Applications
- Satellite Sensors and Techniques

### Proposed Work

This project aims to evaluate the Cloud Optical Properties (COP) products of the JPSS VIIRS team. The work was proposed to be done in cooperation with NGAS colleagues, who developed the algorithm. The evaluation work shall be used for improvements at further developments of the retrievals.

### Summary of Accomplishments and Findings

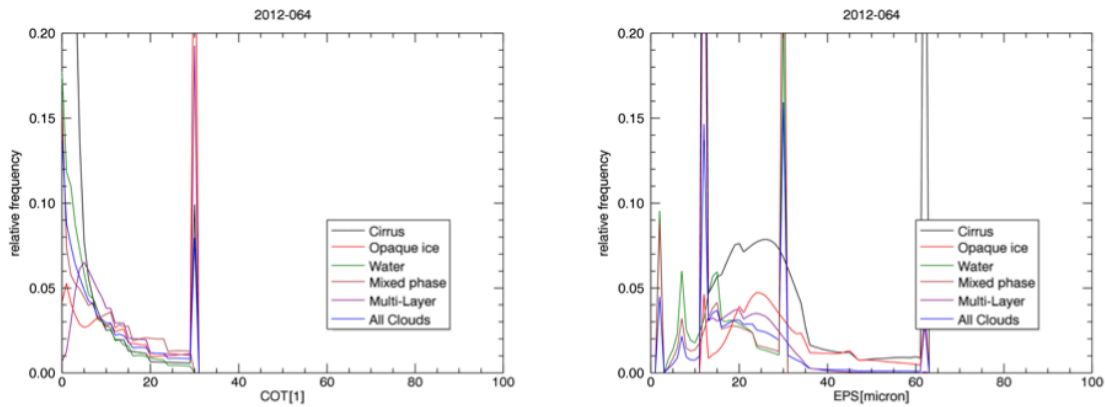
The initial efforts focused on the evaluation of quality flag parameters. We found several issues and confusing definitions related to quality flags, which would heavily impact the usability of the data. Some of the issues could be solved in a new data release in cooperation with NGAS. One example is shown in Fig.16.4.1. There effective radius bigger than 50 microns did not get the correct quality flag.



**Figure 16.4.1.** Example of QF-1 issue for Effective radius bigger than 50 micron.

An overall look to the data exhibits dramatic low success rate of the algorithm.

Second part of our work focused on look-up-table evaluation, which builds the basis of the forward model in the retrieval. We found out that only 65% out of all cloudy daytime pixels have a valid output, which is much lower than for other algorithms (PATMOS-x has more than 95%). Furthermore, the histogram of COD and REF were dominated by peaks, which may be caused by a-priori assumption together with failing convergency. This effect can be seen in the histograms in Fig.16.4.2.



**Figure 16.4.2.** Distribution of COD and REF show obviously artificial peaks in distribution those are cloud type specific

Our analysis could weaken this effect by finding a major error in the look-up-table design. This could be incorporated in the new release which has shown some improvements.

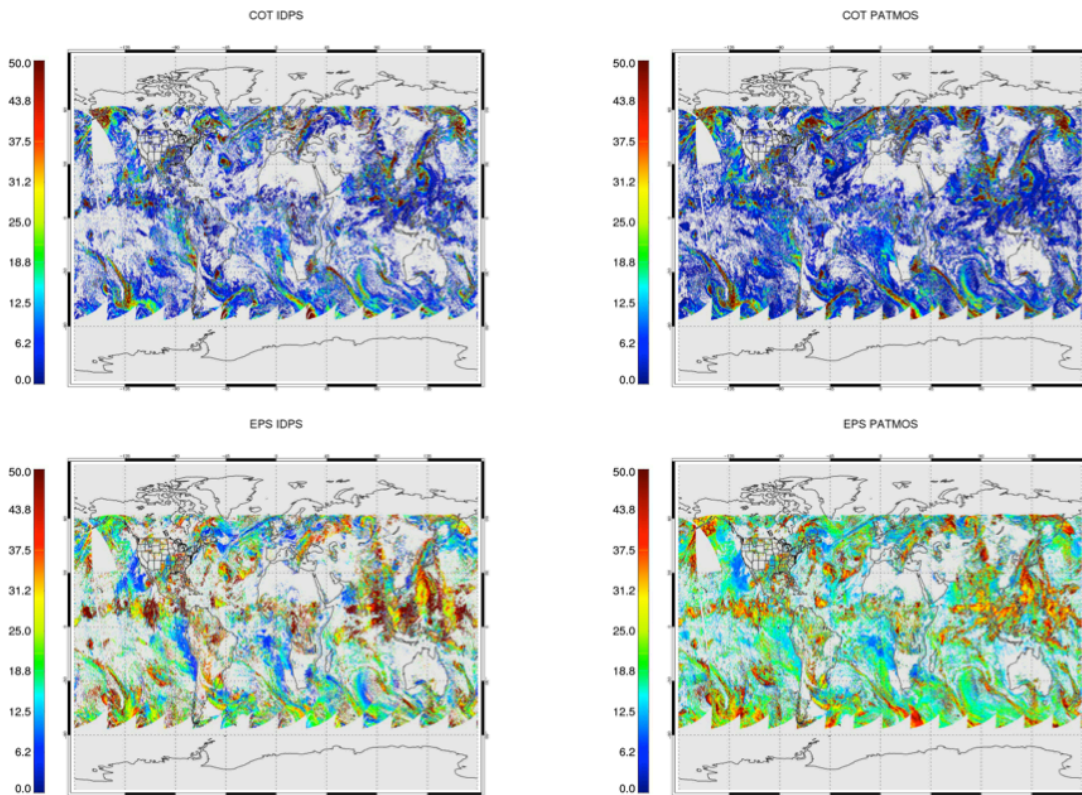
Nevertheless, the IDPS retrieval has still a number of issues, which we summarize in a section of the JPSS Cloud Algorithm Performance Report. The most apparent ones are:

- Bad definition of valid range of COD (30 is much too low) and EPS;
- Quality flags are poorly defined and need to be revised;
- Missing atmospheric correction for ozone and water vapor;
- LUT entries are badly defined. There are many entries at very low sun and sensor angles, but only a few around nadir. Interpolation error is assumed to be big; and
- It seems from Figure 16.4.3, that not all angular problems are solved. The left images are the IDPS output. The scan-line dependence is evident, especially for IDPS REF (lower left). The comparison dataset PATMOS-x does not show these artifacts.

We had to summarize that the COP IDPS algorithm has many issues and needs a major revision.

### Publications and Conference Reports

Heidinger et al., 2012: The JPSS Cloud Cal/Val Team for the JPSS project: JPSS Cloud Algorithm Performance Report, October 2012.



**Figure 16.4.3.** IDPS and PATMOS-x results for Cloud Optical Thickness and Effective Radius (here labeled as COT and EPS) .

## 16.5. VIIRS Cloud Type Algorithm

**CIMSS Task Leader: Corey Calvert**

**CIMSS Support Scientist: Justin Sieglaff**

**NOAA Collaborator: Michael Pavolonis**

### NOAA Long Term Goals

- Weather-Ready Nation

### NOAA Strategic Goals

- Serve society's needs for weather and water
- Support the nation's commerce with information for safe, efficient and environmentally sound transportation

### CIMSS Research Themes

- Satellite Meteorology Research and Applications
- Satellite Sensors and Techniques

### Proposed Work

Clouds play a critical role in Earth's climate system so cloud detection is very important. Polar-orbiting satellites orbit the Earth several times per day and are able to view the entire earth, making them ideal platforms for determining global cloud coverage. Along with accurately detecting where clouds are located it is also important to accurately differentiate between



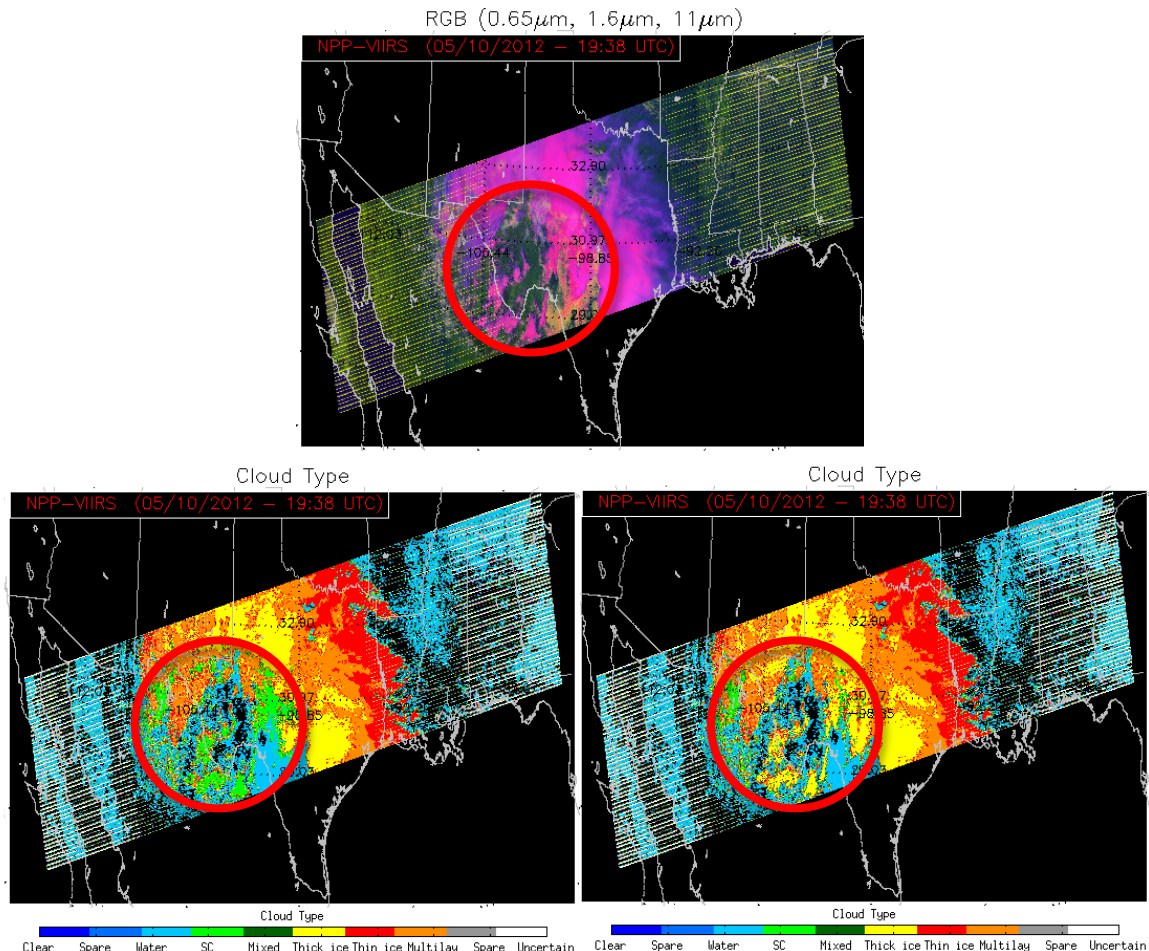
different types of clouds. A cloud type algorithm was developed for the Visible Infrared Imaging Radiometer Suite (VIIRS) on board the Suomi NPP polar-orbiting satellite. The algorithm separates clouds into the following five categories: warm liquid water, mixed phase, opaque ice (deep convection), non-opaque ice (cirrus) and cloud overlap (multiple cloud layers). We propose to evaluate the VIIRS cloud type algorithm and make any necessary modifications to improve its overall performance. This project will ensure that the cloud type algorithm performs accurately throughout the lifetime of the VIIRS instrument.

### **Summary of Accomplishments and Findings**

The initial evaluation of the VIIRS cloud type algorithm involved validating the ability to differentiate between water and ice phases. Cloud pixels identified by the algorithm as liquid water or mixed phase were classified as water phase and pixels identified as opaque ice, non-opaque ice or overlap were classified as ice phase. The VIIRS cloud phase product was evaluated globally using collocated 5 km resolution Cloud-Aerosol Lidar with Orthogonal Polarization (CALIOP) matchup files from May 10, 2012. The space-borne lidar is highly accurate when determining the phase of clouds and can therefore be relied upon to accurately validate the VIIRS cloud type algorithm. Validation was performed when both CALIOP and VIIRS detected either a water or ice cloud. Any collocated pixel determined to be clear sky by either sensor was not used in the validation process.

Initial validation results indicate the VIIRS cloud phase product determined the same phase as CALIOP for about 80% of the pixels validated. After further investigation it was found that a large majority of VIIRS pixels that did not match the CALIOP cloud phase distinction occurred because the VIIRS cloud type algorithm returned a water phase category when the CALIOP algorithm returned ice phase. Looking at a sample granule it appears that several glaciated convective clouds were being misclassified as mixed phase (generally classified as water phase for this validation) instead of ice phase. The top panel in Figure 16.5.1 shows a VIIRS false color image where bare land appears green, ice clouds look bright pink and water clouds are yellowish in color. Focusing on the red-circled area there are several convective clouds that appear bright pink on the false color image. These are opaque ice clouds from the tops of growing thunderstorms. However, the bottom left panel of Figure 16.5.1 shows the VIIRS cloud type algorithm erroneously classified these clouds as mixed phase (green) instead of opaque ice (yellow).

Among others, the VIIRS cloud type algorithm uses a test based on the relationship between the  $11\mu\text{m}$  brightness temperature and the  $8.5\mu\text{m} - 11\mu\text{m}$  brightness temperature difference (BTD) to differentiate between ice and water clouds. This test, called the infrared cloud phase discrimination test, was determined to be the source of the majority of misclassified VIIRS pixels. When this test is applied, a threshold function is used to differentiate water clouds from ice clouds. However, the original threshold function was not calculated using VIIRS data because the instrument was not launched until after the algorithm was developed. Instead, the threshold function was initially chosen based on the modeling of single-layer water and ice clouds (Pavolonis et al., 2005). Now that VIIRS data are available, a new threshold function can be calculated to improve the performance of the infrared cloud phase discrimination test, and therefore, the overall performance of the VIIRS cloud type algorithm. The bottom right panel in Figure 16.5.1 shows the VIIRS cloud type algorithm applied using the newly calculated threshold function. Note that the convective cloud tops in the red-circled area are now correctly identified as opaque ice clouds instead of mixed phase. Early validation results are encouraging, but further evaluation and modifications are likely necessary to ensure the VIIRS cloud type algorithm performs dependably at a high level.



**Figure 16.5.1.** A daytime VIIRS scene over Texas on May 10, 2012 at 1938Z. The top panel is a false color image where ice clouds appear pink and water clouds appear yellowish. The bottom left panel is the VIIRS cloud type product with the original infrared cloud phase discrimination threshold function. The bottom right panel is the VIIRS cloud type product with the updated threshold function.

## References

Pavolonis, Michael J., Andrew K. Heidinger, Taneil Uttal, 2005: Daytime Global Cloud Typing from AVHRR and VIIRS: Algorithm Description, Validation, and Comparisons. *J. Appl. Meteor.*, **44**, 804–826.

## 16.6. VIIRS Cloud Team Computing Equipment Support

**CIMSS Task Leader: M. Foster**

**NOAA Collaborator: A. Heidinger**

**NOAA Long Term Goals**

- Climate Adaptation and Mitigation
- Weather-Ready Nation

**NOAA Strategic Goals**

- Serve society's needs for weather and water





- Understand climate variability and change to enhance society's ability to plan and respond
- Provide critical support for the NOAA mission

### **CIMSS Research Themes**

- Satellite Meteorology Research and Applications
- Satellite Sensors and Techniques

### **Proposed Work**

The goal of this project is to provide computing support for the Cal/Val and analysis tasks of the VIIRS Cloud Team. The processing- and storage- intensive nature of these tasks caused us to seek a distributed processing solution. We intend to leverage the current computing resources at the University of Wisconsin to maximize processing and storage for each dollar spent.

### **Summary of Accomplishments and Findings**

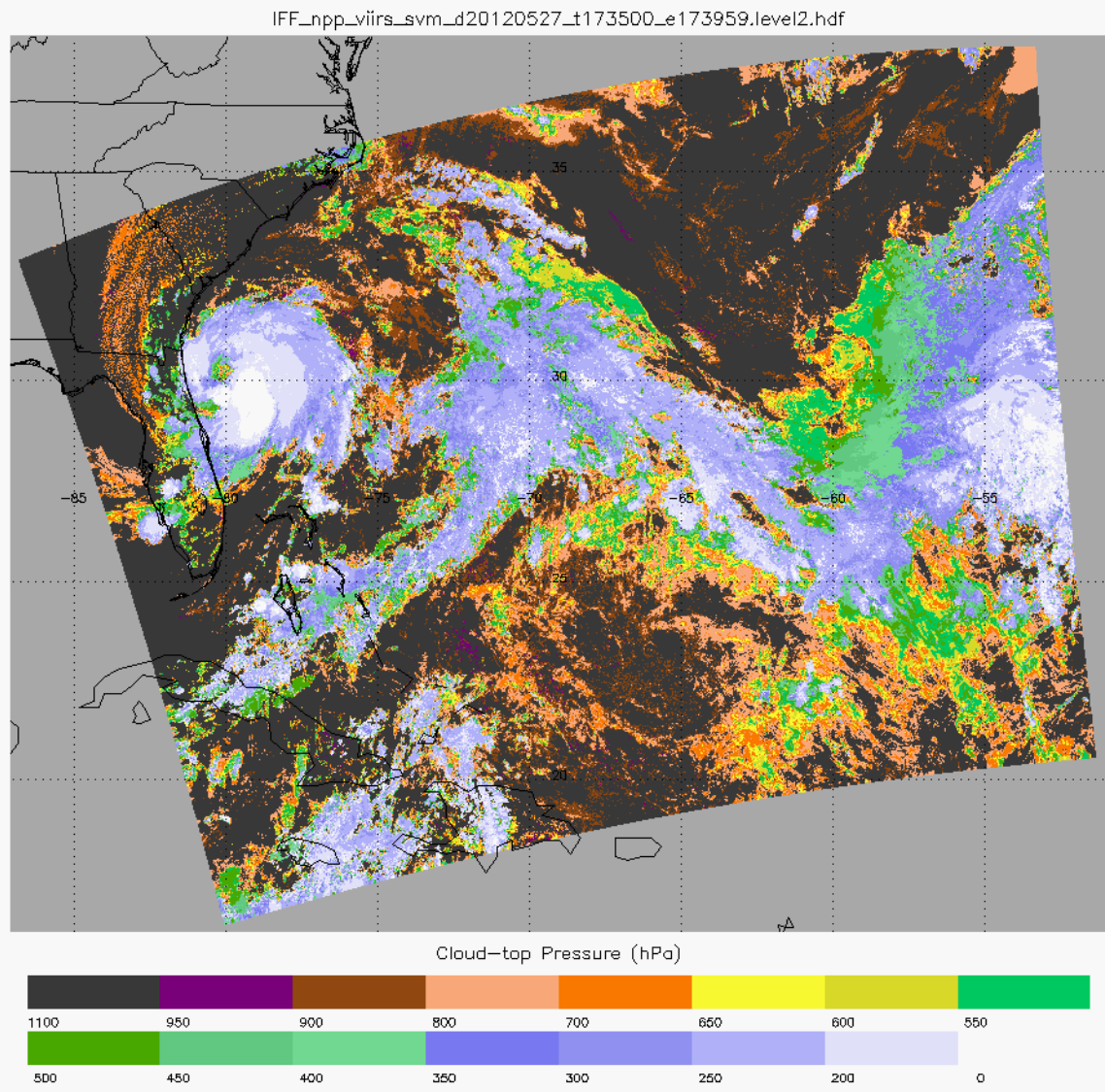
The University of Wisconsin – Madison Space Science and Engineering Center (SSEC) offers computing resources with which to process the proposed Cal/Val. Those resources include a server cluster with a multi-node storage array. To support the computing needs of the VIIRS cloud team and to leverage available resources two Dell PowerEdge R720 Servers were purchased as part of the infrastructure of a larger Science computing cluster (described below).

- 182 TB lustre storage system
- 437 TB lustre storage system
- 240 amd cores (2.7 GB ram/core)
- 64 intel cores (4 GB ram/core)
- Infiniband network
  - Two core FDR10 (40 Gbit/sec) 36 port switches
  - Three SDR (8 Gbit/sec) and two DDR (16 Gbit/sec) edge switches
  - Mix of SDR, DDR, QDR, and FDR10 network cards for all of the servers

Additional services provided by the SSEC Technical Computing division include:

- Nightly backups of servers;
- Mirrored and backed up versioning systems, including CVS and SVN, for storing programs, source code, etc.;
- Archiving to tape for larger datasets;
- Assistance compiling, linking scientific software; and
- Support scheduling cluster processing including scripts, technical support, and analysis for your scripts / cluster programs.

The servers were successfully integrated into the cluster processing nodes, and several scripts were written to facilitate distributed processing of VIIRS data on the cluster. The generation of cloud products has successfully been processed on the ZARA cluster for month-long periods of VIIRS measurements. These products have been integral parts of the VIIRS Cloud Team Cal/Val efforts. Figure 16.6.1 shows an example of one the products generated on the cluster from VIIRS.



**Figure 16.6.1.** Image of AWG Cloud Height Algorithm (ACHA) cloud-top pressure product processed on the ZARA cluster from VIIRS measurements.

## 16.7. NPP-VIIRS Cloud Property EDR Validation Activities

**CIMSS Task Leader: Bryan A. Baum**

**CIMSS Collaborator: Nadia Smith**

**NOAA Collaborator: Andy Heidinger**

### NOAA Long Term Goals

- Climate Adaptation and Mitigation
- Weather-Ready Nation

### NOAA Strategic Goals

- Serve society's needs for weather and water
- Understand climate variability and change to enhance society's ability to plan and respond



- Provide critical support for the NOAA mission

### **CIMSS Research Themes**

- Satellite Meteorology Research and Applications
- Satellite Sensors and Techniques

### **Proposed Work**

Our goal is to provide an assessment of the VIIRS cloud top property EDRs from the first year of operation, with an initial emphasis on finding artifacts and determining the behavior of the cloud top pressure data obtained from the relatively immature set of algorithms adopted in the JPSS framework.

### **Summary of Accomplishments and Findings**

To summarize the analysis in this report, the EDR (aggregated on a 5-km spatial scale) cloud-top pressures (CTP) seem to have serious artifacts. Furthermore the CTP product can only be interpreted correctly through use of the appropriate overall quality flag. Figure 16.7.1 shows the daytime averaged CTP (in hPa) on a  $1^\circ \times 1^\circ$  equal-angle grid for the VIIRS EDR for May 1, 2012. Of interest is that there are (a) no clear-sky regions, (b) very low clouds (high CTP values) present in very arid regions such as deserts, South Africa, and Australia, and (c) very high CTP values in regions over high-elevation land surfaces, which is an unphysical result (cloud-top pressures should be lower than that at the surface).

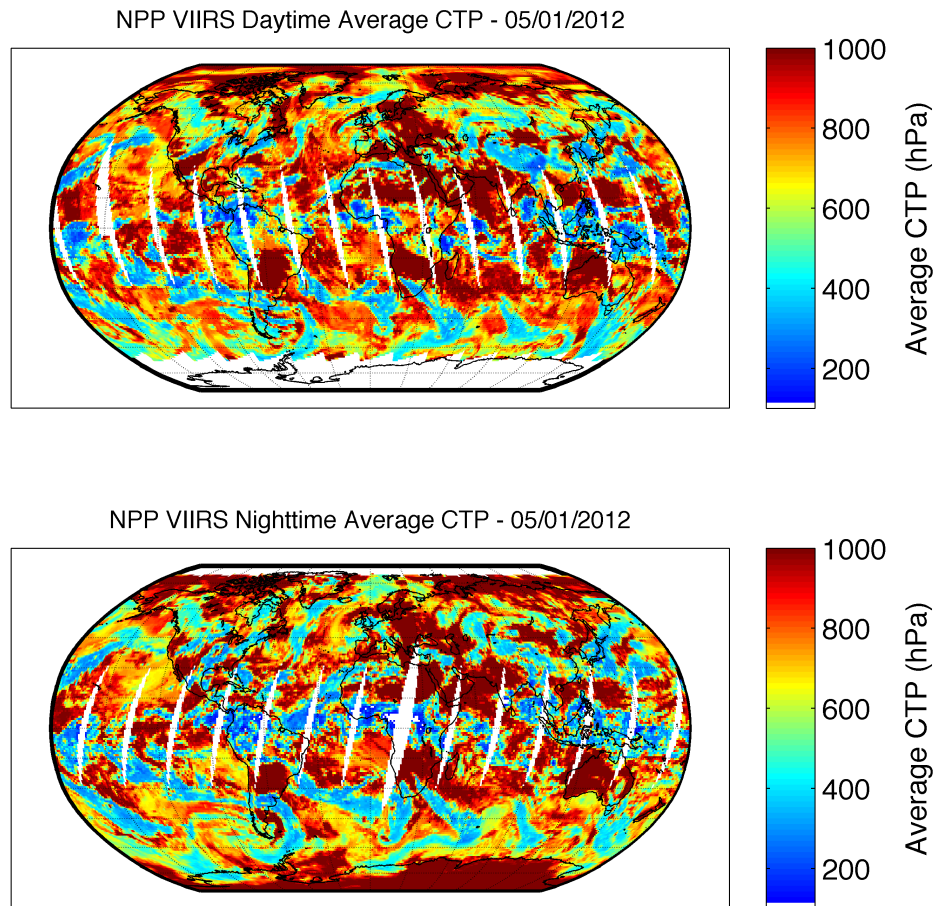
To investigate how/whether the cloud mask is being used, we next focus on the number of CTP retrievals in each  $1^\circ$  equal-angle grid cell, with results in Figure 16.7.2. The number of VIIRS 5-km FOVs (i.e., the individual EDR aggregated pixel results) for which there were CTP results is uniform across the globe. There is one area in the South Pacific Ocean with a higher frequency; this is due to having two swaths overlapping for this brief period. The uniformity in CTP frequency is unexpected because one might expect that the number of CTP retrievals would decrease in regions that generally are cloud free (deserts, arid regions such as Australia, etc.).

To make more sense of these results, we turned to the CTP quality flag called “Overall Quality.” The investigation into the quality flags was needlessly complicated by the difficulty in finding the appropriate documentation. The document, 474-00083\_OAD-VIIRS-CTP-EDR-SW\_RevA\_20120127.pdf, is what a general user would expect to provide information relevant to the EDR, but in fact there is no description of EDR quality flags. The EDR quality flag is defined only in 474-0001-04-02\_Rev-Baseline.pdf. In fact, one has to get to page 309 of 329 total pages (although when you pull it up, it's on page number 288 according to the internal numbering) to actually find the overall quality flag. This is going to be problematic for most users, and in fact, it took us considerable time to track this down.

The documentation for the EDR indicates that the overall quality flag is available only for the “Average Cloud Top Pressure” variable, so this parameter is what is presented. The overall quality flag provides four quartiles. If we now filter the EDR CTP product by this quality flag and keep results for which at least 50% of the retrievals are valid, we arrive at the results shown in Figure 16.7.3, with the number of valid retrievals in each grid cell provided in Figure 16.7.4. The results are very interesting. Note that the extensive areas of low cloud, with very high CTP values, are no longer present. In the daytime data (upper panel), also note that there are systematic gaps in the results in the Northern Hemisphere. This might be expected over ocean since these gaps are caused by the potential presence of sun glint. However, it seems that the angular calculation for sun glint potential is also being applied over land, with a subsequent



downgrading of the overall quality assessment. The reduction in the number of valid retrievals is more than 90% in the areas one would expect for the angular calculation of sun glint potential.

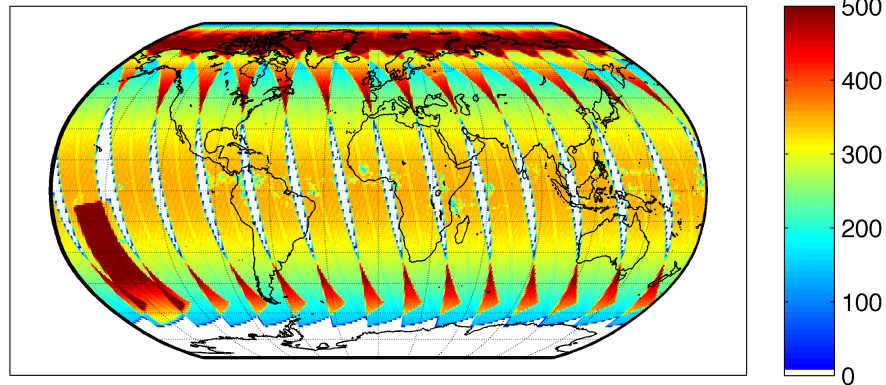


**Figure 16.7.1.** Cloud top pressure (in hPa) on a 1° equal-angle grid for the VIIRS EDR product from May 1, 2012 for daytime (upper panel) and nighttime (lower panel).

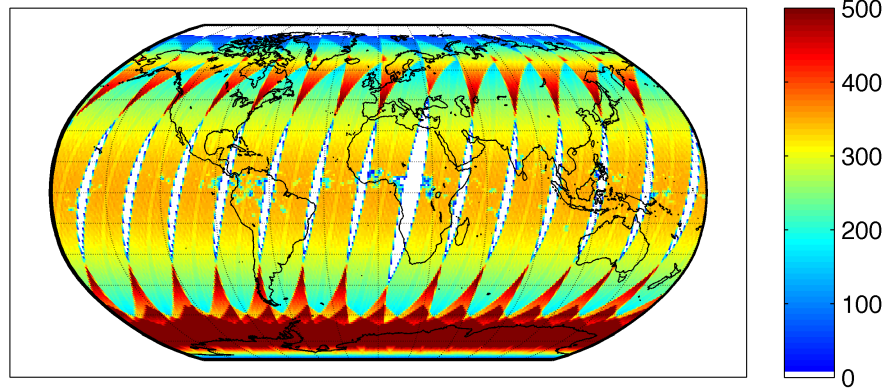
Note that most users of a cloud product tend to work with the cloud parameter as provided in the dataset without use of quality flags. This is certainly the case for the NOAA operational cloud products currently being produced from the AVHRR and geostationary satellites. If the VIIRS EDR product was used without the overall quality flag, general users will have serious questions about the product. Our experience with providing global cloud products is that users generally do not use quality flags, and if they do not go the extra step, it is likely that the interpretation of the cloud products and the ensuing analysis will be done incorrectly.



NPP VIIRS Daytime No. of Clouds per Grid Cell - 05/01/2012



NPP VIIRS Nighttime No. of Clouds per Grid Cell - 05/01/2012



**Figure 16.7.2.** The number of VIIRS IDPS CTP retrievals for each 1° equal-angle grid from May 1, 2012. Note that the number of retrievals is fairly uniform. The area in the South Pacific with higher counts occurred where two orbits overlapped.

### Publications and Conference Reports

This work is summarized in the JPSS Cloud Algorithm Assessment Report, prepared by the JPSS Cloud cal/val team for the JPSS project led by Dr. Andrew Heidinger, NOAA/NESDIS/STAR.

### References

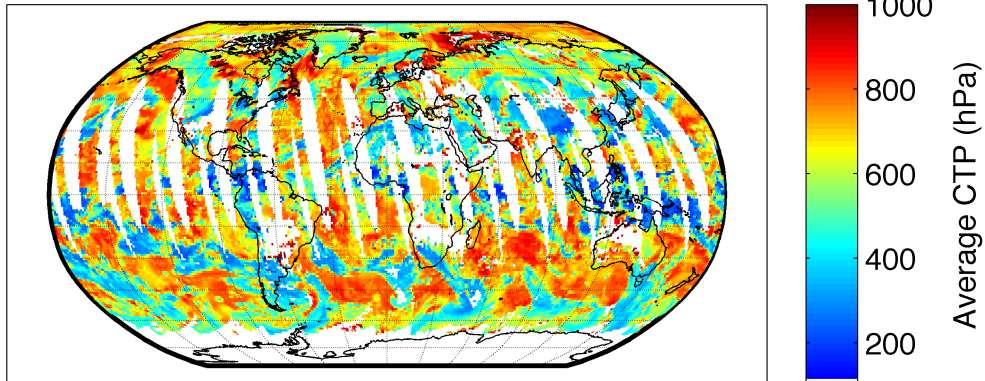
We made use of these two documents for VIIRS documentation; these documents are available at <http://npp.gsfc.nasa.gov/science/documents.html>

Under the Operational Algorithm Description Document list:  
474-00083\_OAD-VIIRS-CTP-EDR-SW\_RevA\_20120127.pdf

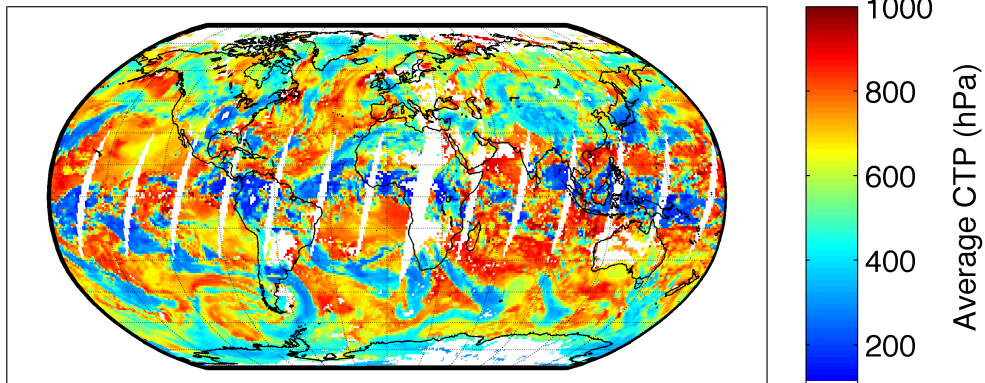
Under the JPSS Common Data Format Control Book group:  
474-0001-04-02\_Rev-Baseline.pdf



NPP VIIRS Daytime Average CTP - 05/01/2012



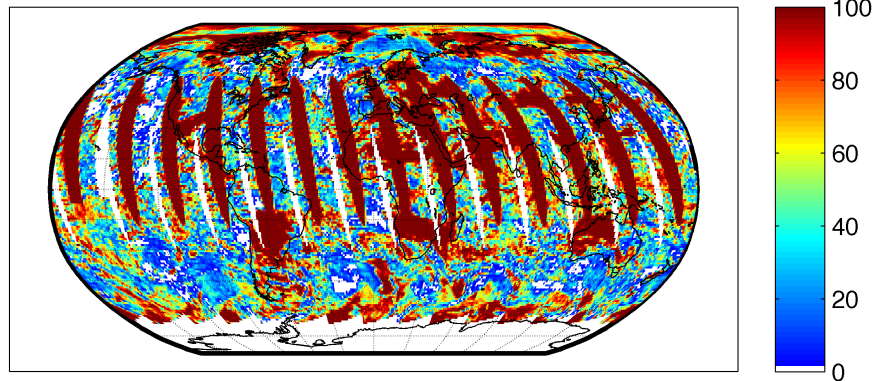
NPP VIIRS Nighttime Average CTP - 05/01/2012



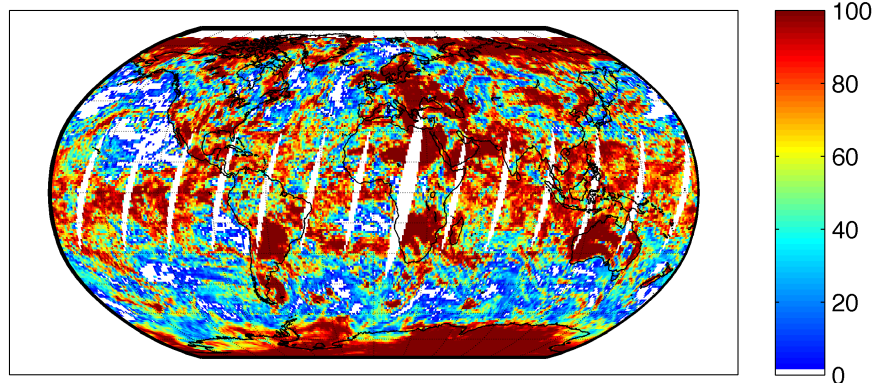
**Figure 16.7.3.** After filtering by the “overall quality” flag, the daytime (top panel) and nighttime (lower panel) cloud top pressure (in hPa) is shown on a 1° equal-angle grid for the VIIRS EDR product from May 1, 2012. Note that the extensive areas of very low cloud are no longer present. Also note that in the Northern Hemisphere, the sun glint regions over ocean receive further reduction in quality, and it appears that the reduction in quality for potential sun glint is applied over land, too.



NPP VIIRS Daytime % of Clouds Reduction per Grid Cell - 05/01/2012



NPP VIIRS Nighttime % of Clouds Reduction per Grid Cell - 05/01/2012



**Figure 16.7.4.** The percentage reduction of VIIRS IDPS CTP retrievals for each 1° equal-angle grid that result from application of the Overall Quality flag. The results are for May 1, 2012. In some regions, more than 90% of the CTP retrievals are filtered out because of the overall quality flag.

## 16.8. CrIS/VIIRS Cloud Height Comparison

**CIMSS Task Leader: Eva Borbas**

**CIMSS Support Scientists: Nadia Smith, Paul Menzel**

**NOAA Collaborator: Andrew Heidinger**

### NOAA Long Term Goals

- Climate Adaptation and Mitigation
- Weather-Ready Nation

### NOAA Strategic Goals

- Serve society's needs for weather and water
- Understand climate variability and change to enhance society's ability to plan and respond

### CIMSS Research Themes

- Satellite Meteorology Research and Applications



## Proposed Work

In addition to cloud heights from VIIRS, the NPP CrIS hyperspectral IR sensor is very capable of generating accurate cloud heights for cirrus clouds at a lower spatial resolution. We expect CrIS cloud height performance to exceed that from VIIRS for cirrus clouds. CIMSS has developed a regression approach (called Dual-Regression method, Smith et al., 2011) to estimate cloud height from CrIS and we will implement this approach on CrIS data for our needs. We use CrIS results to validate the VIIRS cloud height performance in the presence of optically thin cloud. This dataset is important because it also serves as a backup to CALIPSO, should CALIPSO fail.

Proposed work includes:

1. Adaptation of the 4-layer Lapse Rate (4LR) algorithm for use of combined CrIS and VIIRS in night-time cloud situations, package VIIRS+CrIS algorithm for transfer; prepare s/w for routine use; and
2. In preparation for validation of the VIIRS cloud top pressure EDRs, perform and document regional and global tests of CTP with CrIS only (Smith et al., 2011), CrIS plus VIIRS using 4LR and the 3-band Merging Gradient (3MG) (Weisz et al., 2011) algorithms, and CALIOP and MOD06 as reference.

## Summary of Accomplishments and Findings

VIIRS does not have any spectral bands located in H<sub>2</sub>O or CO<sub>2</sub> absorption bands, which degrades its ability to determine semi-transparent cloud properties (including cloud top pressures/heights) compared to that of sensors including even a single absorption channel (Heidinger et al., 2010). In an effort to ensure continuity and consistency between historical cloud products and those provided from the SNPP sensors (and JPSS in the future), we are working to demonstrate a VIIRS plus CrIS cloud algorithm that can extend the AVHRR/HIRS and MODIS/AIRS cloud record.

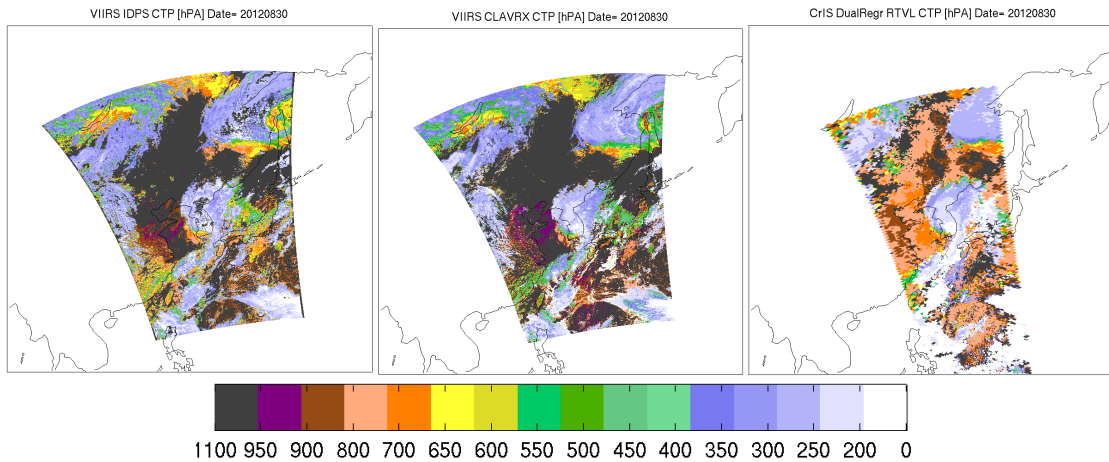
We are exploring several techniques. A single granule of VIIRS and CrIS data from August 2012 over Korea is being used for these initial studies. Figure 16.8.1 shows the VIIRS CTP as retrieved on the IDPS with the operational algorithm along with the results from the research algorithm using an optimal estimation approach; significant differences between operational and research are seen in the high thin clouds, especially in some areas where VIIRS operational assigns high clouds to low altitudes. CrIS Dual Regression (DR) retrievals confirm the locations to be high clouds. The 4 layer lapse rate (4LR) results are still pending co-location software implementation.

In addition to the 4LR and 3MG, we are studying a pseudo VIIRS channel at 13.3 microns statistically constructed from CrIS and VIIRS measurements. The CrIS sensor makes 1305 high spectral resolution measurements from 15.1 to 3.8 microns at 15 km resolution; the measurements in the 15 micron CO<sub>2</sub> absorption bands are especially important for cloud property retrieval. Using the infrared spectral bands on VIIRS at 780 meter resolution and a convolution of the 15 micron spectral measurements on CrIS at 15 km resolution, statistical construction of a 13.3 micron channel at 780 meter resolution is accomplished via data fusion techniques. The VIIRS channels combined with the statistically constructed 13.3 micron channel are then used in a cloud top pressure algorithm that has been developed for the pending Advanced Baseline Imager to be launched in 2015 on GOES-R (Heidinger et al., 2011). Figure 16.8.2 shows early results where the cloud top pressures derived without the 13.3 micron data using an optimal estimation approach that relies on the NCEP Global Data Assimilation System as a first guess. The difference of with and without 13.3 micron data is shown on the right. In high thin cirrus west of North Korea, the ABI algorithm with the 13.3 micron data gets the CTP at 250 hPa while the VIIRS optimal estimation without the 13.3 micron data pins it at the tropopause. In low clouds

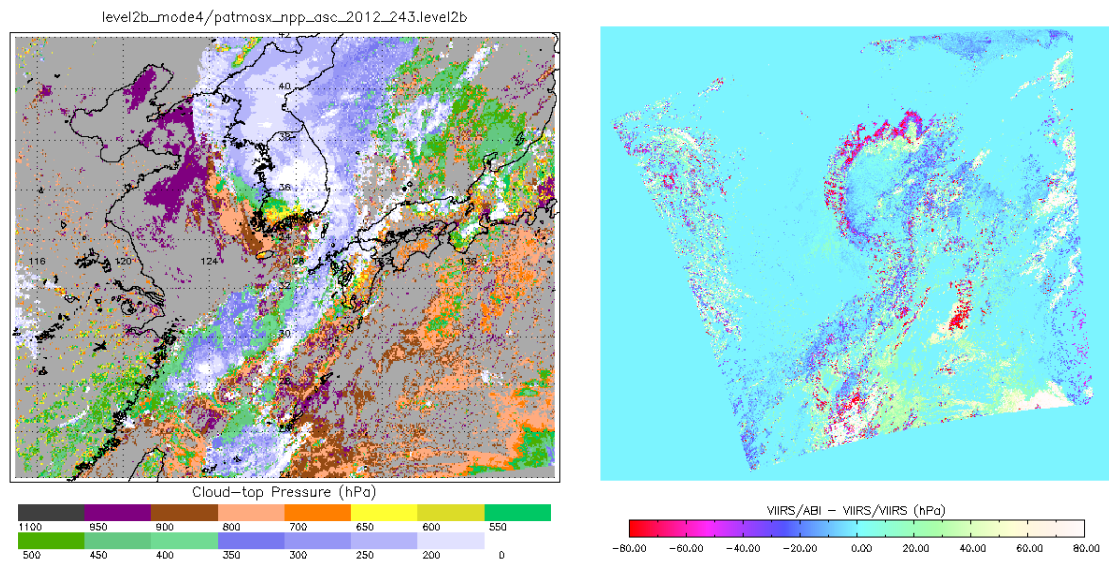




over the Pacific Ocean south of Japan, the 13.3 micron data helps the ABI algorithm lift the clouds off the ocean surface, in better agreement with MODIS results (not shown).



**Figure 16.8.1.** Cloud Top Pressure (hPa) comparison for August 30, 2012 UTC 0424 granule. (left) The official NOAA VIIRS-only CTP EDR from the IDPS, (middle) the CLAVRX VIIRS-only CTP product, (right) the UW Dual Regression CrIS-only CTP retrieval.



**Figure 16.8.2.** (left) 28 August 2012 cloud top pressures derived from VIIRS data without the 13.3 micron data using an optimal estimation approach that relies on the NCEP Global Data Assimilation System as a first guess. (right) Difference of CTPs with minus without 13.3 micron data.

**References**

Smith, W.L., E. Weisz, S.V. Kireev, D.K. Zhou, Z. Li and E.E. Borbas, 2011: Dual- Regression Retrieval Algorithm For Real-time Processing of Satellite Ultraspectral Radiances, submitted to *JAMC*.



Weisz, E., W.P. Menzel, N. Smith, R. A. Frey, E.E. Borbas, and B. A. Baum, 2011: An Approach for Improving Cirrus Cloud Top Pressure/Height Estimation by Merging High-Spatial-Resolution Infrared-Window Imager Data with High-Spectral-Resolution Sounder Data, *J. Appl. Meteor. Climatol.*, **51**, 1477–1488. doi: <http://dx.doi.org/10.1175/JAMC-D-11-0170.1>

Heidinger, Andrew K, 2011: ABI Cloud Height Algorithm (ACHA) Algorithm Theoretical Basis Document (ATBD), GOES-R Program Office. ([http://www.goes-r.gov/products/ATBDs/baseline/Cloud\\_CldHeight\\_v2.0\\_no\\_color.pdf](http://www.goes-r.gov/products/ATBDs/baseline/Cloud_CldHeight_v2.0_no_color.pdf))

Heidinger, A. K., M. J. Pavolonis, R. E. Holz, B. A. Baum, and S. Berthier, 2010: Using CALIPSO to explore the sensitivity to cirrus height in the infrared observations from NPOESS/VIIRS and GOES-R/ABI. *J. Geophys. Res.*, 115.

## 16.9. VIIRS Evaluation Using Satellite Observations

**CIMSS Task Leader: Robert Holz**

**NOAA Collaborator: Andrew Heidinger**

**NOAA Long Term Goals**

- Climate Adaptation and Mitigation
- Weather-Ready Nation

**NOAA Strategic Goals**

- Serve society's needs for weather and water
- Understand climate variability and change to enhance society's ability to plan and respond

**CIMSS Research Themes**

- Satellite Meteorology Research and Applications

### Proposed Work

This project supports the NPP-VIIRS cloud and aerosol evaluation as part of the Joint Polar Satellite System (JPSS). The VIIRS cloud algorithms were developed by Northrop Grumman Aerospace Systems (NGAS). Before launch, the performance of these algorithms (both aerosol and clouds) had not been well characterized due to a lack of pre-launch proxy data with only small (24 granule) proxy dataset available for evaluation. The successful launch of Suomi NPP provides for the first time the ability to evaluate the NGAS algorithms using real observations. Using the extensive tools and processing capabilities developed as part of our current support for JPSS, we provide satellite inter comparisons with VIIRS with a focus on NASA A-Train cloud products.

### Summary of Accomplishments and Findings

We completed a significant milestone this year with the completion of the JPSS cloud assessment report which was delivered to the JPSS program in December of 2012. This project supported both the evaluation and report preparation. Our work has identified and corrected two issues during this first year. First, the team identified an error in the COP lookup table interpolation. Second, the team developed an improvement to the height assessment of low level clouds that will impact the accuracy performance. The second fix has not been implemented into the IDPS yet.

Even with these improvements, the team has found major issues remain with the cloud products. Artifacts that remain in the products jeopardize their utility until solutions can be found and



implemented. For these reasons, we do not feel these products are useable by NOAA customers at this time. The major issues that have been identified are:

- Low convergence rates for cloud retrievals. For example, roughly 60% of cloudy pixels have IP COP results classified as successful;
- Cloud top heights are severely underestimated in general for most transmissive high-level clouds (i.e., cirrus), especially in the Tropics, but can also exhibit a tendency for severe over-estimation at times when solutions appear to follow the Tropopause Level;
- Though this issue will be addressed in a future IDPS release, low-level CTH are too high, often by as much as 2-3 km. This is most evident over oceans in areas of widespread stratocumulus decks;
- The inference of cloud base height is challenging for a passive VIS/IR sensor such as VIIRS. The cloud base height product depends critically the performance of the CTH and cloud phase, among other things, as input. Comparisons with the active radar of CloudSat indicate that there is very limited accuracy obtained at this time. The product demonstrates less accuracy for thin cirrus than water cloud layers;
- For most of the first year, COP exhibited erroneous distributions of optical thickness and particle size due to problems associated with the look-up tables (LUTs). Earlier analyses led to an updated LUT being developed for IDPS;
- With the updated LUT that went into IDPS operations on 5 September, 2012, the COP does not return a valid result for about a third of the cloudy pixels, a much higher number than other operational algorithms;
- The accuracy specification is met for some of the COP parameters for some phases. The precision specification is generally not met;
- With the updated LUT that went into IDPS operations on 5 September, 2012, there are still indications of LUT-related issues. The COP comparisons relative to NOAA and NASA results indicate a large scan angle dependence that hints at continued flaws in the COP LUTs. Discontinuities in the distributions of the latest COP results also indicate remaining issues with the COP convergence method;
- The team has found difficulty in using the quality flags and has found them to be generally inadequate. The quality flags are designed for analysis to determine specification compliance. Their use by the community will be problematic. The team has made suggestions for additions to the COP quality flags to address these issues; and
- Taken together, some issues such as QA flags could be resolved given sufficient resources. However, the COP and CTP/CTH/CTT algorithms suffer from a lack of operational maturity. The ADL may lack the necessary ancillary datasets required to help improve products over land surfaces.

We are currently working to address some of the issues with NGAS and continue provide recommendations to the JPSS project.

## **16.10. VIIRS Cloud Product ADL Support**

**CIMSS Task Leader: Geoff Cureton**

**CIMSS Support Scientist: Denis Botambekov**

**NOAA Collaborator: Andrew Heidinger**

**NOAA Long Term Goals**

- Weather-Ready Nation

**NOAA Strategic Goals**

- Serve society's needs for weather and water



- Support the nation's commerce with information for safe, efficient and environmentally sound transportation
- Provide critical support for the NOAA mission

#### **CIMSS Research Themes**

- Satellite Meteorology Research and Applications
- Satellite Sensors and Techniques

#### **Proposed Work**

The Algorithm Development Language (ADL) is a processing system developed by Raytheon to allow users to make and test modifications of official VIIRS JPSS algorithms. ADL is complex and requires training. This project supports the use of ADL by the JPSS Cloud Team led by Andrew Heidinger. ADL is an important tool to allow scientists at CIMSS to convey changes to the JPSS program office.

#### **Summary of Accomplishments and Findings**

Cloud Team learned to:

- Execute ADL on select test cases,
- Modify VCM thresholds, and
- Modify Cloud Phase Thresholds.

### **16.11. McIDAS-V Support for Suomi NPP / JPSS**

**CIMSS Task Leader: Thomas Achtor**

**CIMSS Support Scientists: Tom Rink, Tommy Jasmin**

**NOAA Collaborators: Don Hillger (NESDIS/StAR Imagery Applications Team Lead),  
Michael Denning (NOAA Satellite Operations Facility, Suitland, MD)**

#### **NOAA Long Term Goals**

- Climate Adaptation and Mitigation
- Weather-Ready Nation
- NOAA Enterprise Objectives

#### **NOAA Strategic Goals**

- Serve society's needs for weather and water information
- Understand climate variability and change
- Provide critical support for the NOAA mission

#### **CIMSS Research Themes**

- Satellite Meteorology Research and Applications
- Satellite Sensors and Techniques
- VIIRS Cloud Property Research

#### **Proposed Work**

CIMSS will expand general JPSS support to improve ease-of-use, and provide key additional functionality, including:

1. Continue to make improvements, based on user feedback, to the graphical user interface components in order to simplify the selection of coverage area and products of interest;
2. McIDAS-V should provide an option, integrated into the GUI, to re-grid VIIRS data to handle the bow-tie deletion artifact. As a result of the new mechanism employed by VIIRS to maintain consistent spatial resolution from nadir to limb, the underlying data structure removes redundant pixel values on successive scans. The resulting imagery, when displayed using the default McIDAS-V sampling and object model, appears as



- though there may be missing data near the limb of each granule. Currently this is available as a plugin;
3. Several users have expressed a desire to run various analyses on JPSS data in McIDAS-V, and have the capability to write these processed data to disk in a more generally usable, intermediate format such as satellite-CF compliant netCDF. We want to leverage the Java netCDF library and add this capability; and
  4. The NESDIS/StAR Imagery and Visualization Team has specific JPSS support needs, including the ability to batch run various processing algorithms, and to produce RGB composite imagery. We wish to provide the necessary functionality via the McIDAS-V Jython scripting interface, which is currently under development. This group also needs McIDAS-V as a visualization and evaluation tool for the Imagery EDR products. We will expand on progress made to date to provide this capability.

### **Summary of Accomplishments and Findings**

A new, stable version of McIDAS-V with support for Suomi NPP instrument SDRs: Visible/Infrared Imager Radiometer Suite (VIIRS), the Advanced Technology Microwave Sounder (ATMS), and the Cross-track Infrared Sounder (CrIS), has been made available to the public. This release includes the external ancillary metadata files required for instrument calibration and quality control indication, and will be updated as necessary in future releases for changes in instrument characteristics.

McIDAS-V can display, analyze and interrogate SDRs, available from the NOAA CLASS, UW-Madison PEATE, and IDPS from a simple set of user interface operations without any knowledge of the underlying storage formats. This capability is unique.

VIIRS RGB composites can be generated. This capability is currently available as a plugin, and has been tested by several users (Figure 16.11.1). A re-gridding capability to handle visual artifacts displaying VIIRS, including bow-tie deletion, is also available as a plugin. Complete CrIS spectra can now be interrogated in the McIDAS-V Multi/Hyper-Spectral interface (Figure 16.11.2)

Progress has been made towards providing these various capabilities for the Imagery and higher level product EDRs.

The McIDAS-V bundle capability (saving state including data and operations) has been implemented for Suomi NPP data. This allows users to quickly restore a state of analysis, and to easily share it with colleagues via a single .mcvz file.

McIDAS-V will now allow users to work with any geolocated data in a Suomi NPP granule. This means information such as solar and lunar angles, and quality flags, are now available to users for visualization, masking, etc.

### **Publications and Conference Reports**

Rink, Thomas D.; Jasmin, T., and Achtor, T.: McIDAS-V: Visualization and analysis capabilities for JPSS. Annual Symposium on Future Operational Environmental Satellite Systems, 8th, New Orleans, LA, 22-26 January 2012. American Meteorological Society, Boston, MA, 2012.

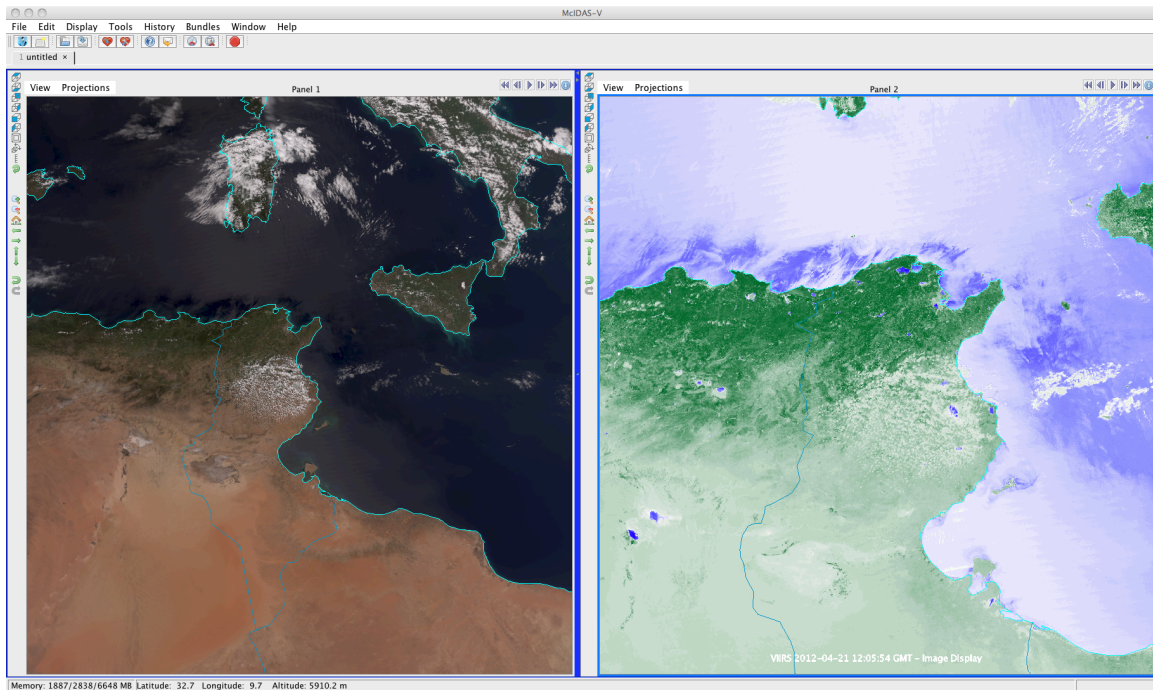
Rink, Thomas; Jasmin, T., and Achtor, T.: Engineering support for JPSS instruments and data formats in McIDAS-V. Annual Symposium on Future Operational Environmental Satellite



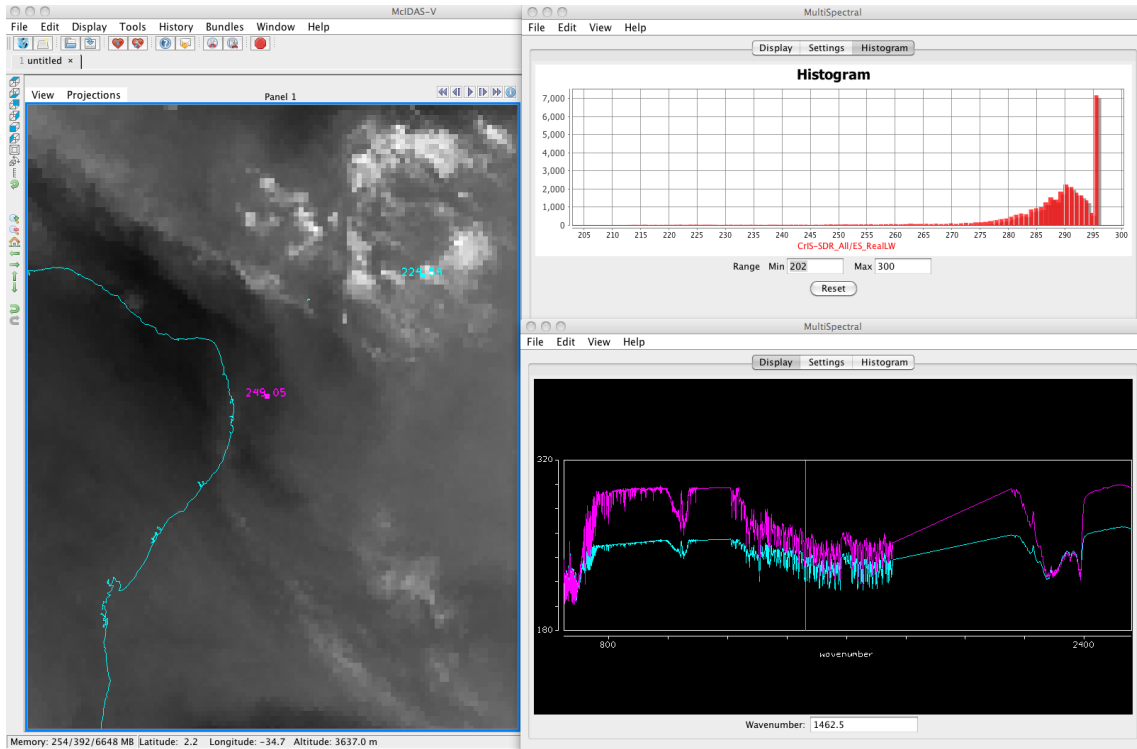
Systems, 8th, New Orleans, LA, 22-26 January 2012. American Meteorological Society, Boston, MA, 2012.

Straka III, William; Rink, T.; Schmit, T.; Jasmin, T.; Heidinger, A., and Achtor, T.: Routine Satellite Derived Product Monitoring and Validation from GOES, JPSS, and GOES-R. 92<sup>nd</sup> AMS Satellite Meteorology Conference, New Orleans, LA, 22-26 January 2012. American Meteorological Society, Boston, MA, 2012.

Straka III, William; Jasmin, T.; Rink, T.; Lindsey, D.; Hillger, D.; Miller, S., and Achtor, T.: McIDAS-V, Visualization and Data Analysis for Suomi National Polar-orbiting Partnership. 29<sup>th</sup> Conference on Environmental Information Processing Technologies, Austin, TX, 05-10 January 2013. American Meteorological Society, Boston, MA, 2012.



**Figure 16.11.1.** This image shows a simple formula and color enhancement applied to VIIRS granules to produce a Normalized Difference Vegetation Index (NDVI) on the right panel and an M5, M4, M3 RGB on the left, over North Africa. The formula is  $(I2 - I1) / (I2 + I1)$ , where I1 is Imager Channel 1 and I2 is Imager Channel 2. The VIIRS granules were re-gridded to a Lambert Equal Area 760 m and 380 m resolution grid to account for bow-tie deleted instrument FOVs. The display was created via the Python-based, user defined computation component of McIDAS-V.



**Figure 16.11.2.** McIDAS-V provides a novel way to visualize and interrogate hyperspectral data. Above, all CrIS channels can be manipulated bi-directionally (from both display windows). Here a CrIS SDR (eastern Brazil) is automatically regridded to handle the spatially incoherent storage of CrIS FOVs.

## 17. SSEC/CIMSS Research Tasks in Support of the Suomi NPP and JPSS Programs

### 17.1. A Broad Scope of Calibration/Validation and Independent Verification and Validation Activities in Support of JPSS, with Emphasis on CrIS SDRs

**CIMSS Task Leaders: Hank Revercomb, Dave Tobin**

**CIMSS Support Scientists: Fred Best, Bob Knuteson, Joe Taylor, Lori Borg, Dan DeSlover**

**NOAA Collaborator: Yong Han**

#### NOAA Long Term Goals

- Climate Adaptation and Mitigation
- Weather-Ready Nation

#### NOAA Strategic Goals

- Serve society's needs for weather and water
- Understand climate variability and change to enhance society's ability to plan and respond
- Provide critical support for the NOAA mission

#### CIMSS Research Themes

- Satellite Meteorology Research and Applications
- Satellite Sensors and Techniques



## **Proposed Work**

SSEC/CIMSS has proposed to support a broad scope of activities aimed at providing the government with expertise in specific technical areas related to the JPSS mission. The general purpose of this work is to provide expertise that: (1) reduces schedule, cost, and performance risk; (2) helps assess performance of industry; (3) points to feasible observing system improvements; and (4) leads to increased positive impact of JPSS goals, by making use of the broad experience in instrument design, testing, algorithms, and science gained from previous and ongoing UW-Madison SSEC/CIMSS research activities. Our efforts for this period of performance have been devoted to performing our various cal/val tasks for characterization, refinement, and reporting of the CrIS SDRs in the Early Checkout and Extended Cal/Val phases.

## **Summary of Accomplishments and Findings**

The major focus of our recent efforts has been to perform our various post-launch CrIS SDR cal/val tasks. A summary of the work performed is provided below, by task.

### ***Support CrIS Planning and Review Meetings/Telecons***

We supported the appropriate NPP, JPSS, and CrIS test related meetings, telecons, and conferences under this task. Examples include weekly JPSS cal/val telecons, JPSS FM2 telecons, CALCON, AGU, and AMS.

### ***CrIS Pre-launch Test Support and Performance Analysis***

We participated in regular Thursday JPSS telecons in support of CrIS FM-2 pre-launch testing and sensor improvements. As anticipated the level of effort for this task during this period of performance was relatively small.

### ***Post-launch CrIS RDR and SDR Cal/Val Tasks***

This task comprised the large majority of our efforts during the past period of performance to perform our post-launch cal/val tasks for CrIS FM-1. These tasks include a range of post-launch assessment/validation efforts including “quick look” type analyses and assessments performed very early after launch as well as more accurate and detailed analyses performed later in the evaluation period. Our cal/val tasks are:

1. Internal consistency checks on Radiometric Calibration,
2. Radiometric Non-linearity Evaluation,
3. Radiometric Noise assessment,
4. Variable artifact assessment using Principle Component Analysis,
5. Early broadband comparisons with GOES and other GEOs,
6. Clear sky Observed minus Calculated Analysis,
7. Internal Consistency checks on spectral self-apodization correction and resampling,
8. Analysis of non-uniform scene effects on the ILS,
9. SDR evaluations using SNO comparisons with IASI and AIRS,
10. CrIS/VIIRS Radiance Comparisons,
11. ICT Environmental Model Evaluation and Refinement, and
12. In-orbit RU Estimation.

Example accomplishments from the previous reporting period include in part:

1. Use of the UW-Madison/UMBC CCAST calibration software to demonstrate early performance,
2. Identification of a scan direction bias that was resolved by updating the FIR filter,





3. Evaluation of non-linearity correction parameters to minimized FOV-to-FOV radiometric differences,
4. Assessment and monitoring of FOV-to-FOV spectral calibration,
5. Inter-calibration of CrIS with Aqua AIRS and METOP-A IASI,
6. Intercalibration of CrIS and VIIRS,
7. Analysis of spectral ringing artifacts and identification of the on-board numerical filter as the source of the majority of the ringing,
8. Establishment of a radiometric calibration uncertainty chain regarding nonlinearity corrections, and
9. Initial estimates of the CrIS on-orbit radiometric uncertainty.

Below is a list of the various presentations we have given as part of the CrIS SDR Cal/Val meetings:

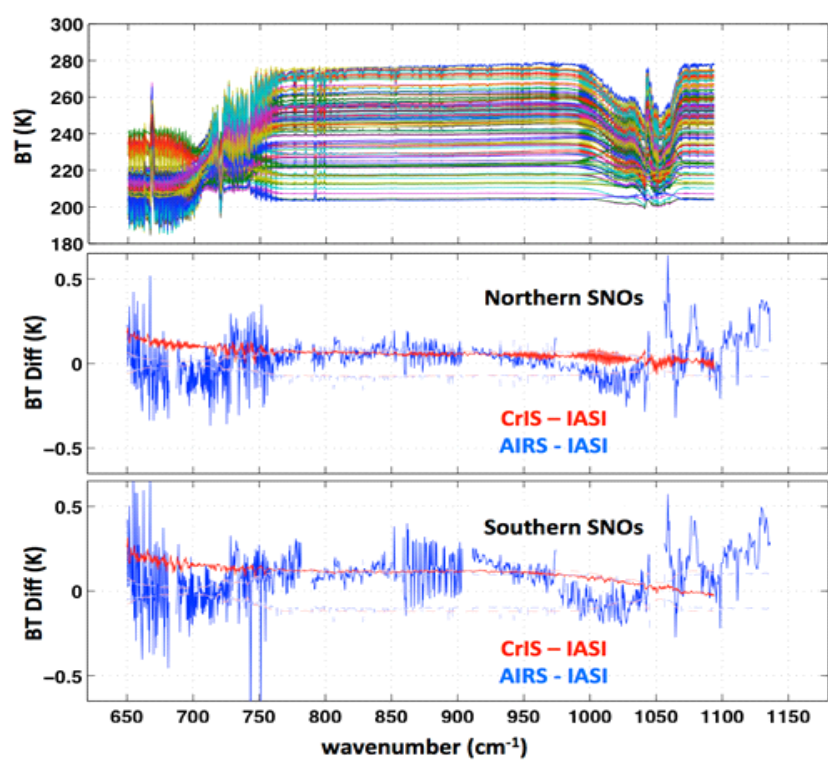
- 29 Jan 2012, UW Status Report (First light images and spectra; Spectral consistency; Phases; Noise analysis; a2 analysis; ADL/CSPP processing);
- 01 Feb 2012, UW Status Report (Phases and Imaginary Parts; CSPP/ADL Debugging);
- 08 Feb 2012, Interfov Analysis;
- 15 Feb 2012, UW Status Report (ADL patches; Diagnostic Mode data analysis; CrIS/VIIRS collocations/comparisons);
- 22 Feb 2012, UW Status Report (Nonlinearity analysis);
- 07 Mar 2012, UW Status Report (SW band comparisons of CCAST and ADL; v33 ILS parameters; a2 analysis; Comparisons with AIRS);
- 07 Mar 2012, UW Status Report; Recommendations for v33 Eng. Packet;
- 14 Mar 2012, CrIS OPD sweep direction dependent bias investigation;
- 28 Mar 2012, March 26 Restart Analysis;
- 28 Mar 2012, NF/sweep direction bias investigation;
- 25 Apr 2012, UW Status Report (Impact of new FIR filter; IDPS/ADL comparisons);
- 13 Jun 2012, Status of VIIRS-CrIS Comparisons: 26 May 2012 example;
- 20 Jun 2012, CrIS Imaginary Part Flag Study: IDPS versus UW-ADL (CSPP);
- 26 Jun 2012, CrIS Responsivity Study;
- 11 Jul 2012, Orbital Dependence of CrIS Responsivity: What does it mean?;
- 18 Jul 2012, Orbital dependence of CrIS Responsivity: Channeling explains the 1<sup>st</sup> order change;
- 01 Aug 2012, Update on CrIS/VIIRS comparisons;
- 03 Oct 2012, CrIS/AIRS Radiometric Comparisons; Daily Mean FOV-2-FOV Radiometric Differences;
- 17 Oct 2012, Inter-FOV Spectral and Radiometric Differences Update;
- 31 Oct 2012, Non-uniform scene ILS effects and correction: Initial analysis for CrIS;
- 16 Jan 2013, Sensitivity of the CrIS Sensor to the Vibration Environment of the Suomi NPP Satellite: SW PCA; and
- 20 Mar 2013, Evaluation of CrIS Spectral Ringing.

Our efforts have also been summarized in our monthly and quarterly project reports. Additionally, see the following section for a list of conference presentations, extended abstracts, and papers related to these efforts.

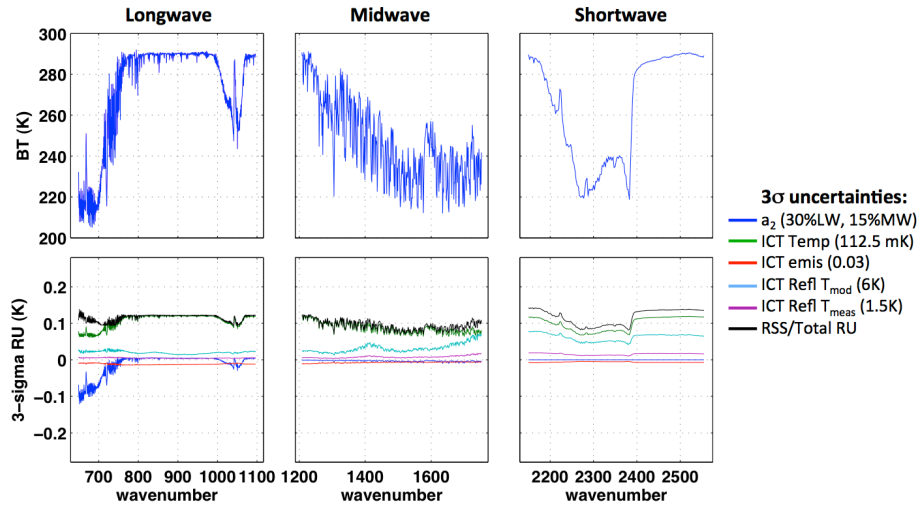
The current status of the CrIS radiometric assessment is captured partially in Figures 17.1.1 and 17.1.2. Evaluation efforts to date show that the spectral and radiometric performance of CrIS is very good, yet with some remaining issues requiring further investigation. Figure 17.1.1 compares CrIS to AIRS and IASI-A sensors for simultaneous nadir overpasses. Agreement at the



0.2 K level is seen across most wavenumbers. Various issues due to CrIS, as well as AIRS and IASI, at lower levels are also evident in these comparisons and are the topics of various on-going investigations by the various sensor teams. Figure 17.1.2 shows the expected Radiometric Uncertainty (RU) of Suomi NPP CrIS, which is better than 0.2K 3-sigma for a typical Earth view spectrum for all wavenumbers, with major uncertainty contributions from the ICT predicted radiance knowledge and radiometric nonlinearity. Spectral calibration contributions, including inter-FOV spectral calibration, are negligible to the RU. Not shown in Figure 17.1.2 are component uncertainties due to two unresolved calibration artifacts including a spectral ringing (Gibbs effect) artifact that is largest at the spectral band edges, and small artifacts seen for cold scene temperatures in the shortwave band. Further diagnosis of these issues is underway, and their identification may have important ramifications for future testing of the JPSS-1 and JPSS-2 sensors and/or calibration algorithms.



**Figure 17.1.1.** Summary of on-orbit comparison between CrIS brightness temperature spectra and both AIRS and IASI. All data from February-November 2012 that meets inter-comparison criteria (within 20 minutes, and 3° degrees viewing angle, with viewing angle <30° for AIRS and near nadir for IASI) are used. The dashed curves are error estimates indicating that most of these differences are significant. While these results will be the subject of detailed studies for considerable time, it is clear that the agreement is very good, especially between CrIS and IASI.



**Figure 17.1.2.** The Suomi NPP CrIS Radiometric Uncertainty (RU) estimate for a typical Earth view spectrum, with component uncertainties from the nonlinearity corrections ( $a_2$  uncertainty), ICT temperature uncertainty, ICT emissivity uncertainty, and ICT reflected temperature uncertainty. The RU is less than  $\sim 0.2$  K for all wavenumbers and scene temperatures.

### Publications and Conference Reports

Hank Revercomb, Dave Tobin, Bob Knuteson, Dan DeSlover, Joe Taylor, Graeme Martin, Ray Garcia, Lori Borg, “New Results from the Cross-track Infrared Sounder (CrIS) on NPP, Part 1”, The 18th International TOVS Study Conference (ITSC-18), Toulouse, France, 21-27 March 2012. <http://cimss.ssec.wisc.edu/itwg/itsc/itsc18/program/files/ITSC-18-Revercomb-Toulouse-21Mar12-f.pdf>

Dave Tobin, Hank Revercomb, Bob Knuteson, Dan DeSlover, Joe Taylor, Graeme Martin, Ray Garcia, Lori Borg, “New Results from the Cross-track Infrared Sounder (CrIS) on NPP, Part 2”, The 18th International TOVS Study Conference (ITSC-18), Toulouse, France, 21-27 March 2012.

Tobin, D. C., H. E. Revercomb, J. K. Taylor, R. O. Knuteson, D. H. DeSlover, L. A. Borg, Cross-track Infrared Sounder (CrIS) Spectral Radiance Calibration and Evaluations, IRS 2012: Proceedings of the International Radiation Symposium, American Institute of Physics press, paper under review.

Revercomb, H., F. Best, R. Knuteson, D. Tobin, J. Taylor, J. Gero, Status of High Spectral Resolution IR for Advancing Atmospheric State Characterization and Climate Trend Benchmarking: A Period of Both Opportunity Realized and Squandered, IRS 2012: Proceedings of the International Radiation Symposium, American Institute of Physics press, paper under review.

Performance of CrIS on NPP, David Tobin, Hank Revercomb, Robert Knuteson, Dan DeSlover, Joe Taylor, Lori Borg, Fred Best, CALCON 2012, 27-30 August 2012, Logan, Utah. (presentation)

CrIS Calibration and Validation, Larrabee Strow, Howard Motteler, Paul Schou, Scott Hannon, David Tobin, CALCON 2012, 27-30 August 2012, Logan, Utah. (presentation)



UW CrIS SDR Status Report, talk presented at the Suomi NPP SDR Provisional Product Review, NCWCP, College Park, MD, 23-24 October 2012.

The Cross-track Infrared Sounder (CrIS) on Suomi NPP: Expected Radiometric and Spectral Performance and Calibration/Validation Results: Part I, Henry E. Revercomb et al., paper number 8527-1 (Invited talk), SPIE 2012 Asia-Pacific Remote Sensing, 29 Oct- 1 Nov 2012, Kyoto, Japan.

The Cross-track Infrared Sounder (CrIS) on Suomi NPP: Expected Radiometric and Spectral Performance and Calibration/Validation Results: Part II, Daniel H. DeSlover et al., poster number 8527-51, SPIE 2012 Asia-Pacific Remote Sensing, 29 Oct- 1 Nov 2012, Kyoto, Japan.

Cross-track Infrared Sounder (CrIS) Spectral Radiance Calibration and Evaluations, David Tobin et al., poster # A33N-0352, AGU 2012 Fall Meeting, 3-7 December 2012, San Francisco, CA. (extended abstract)

Suomi NPP/JPSS Cross-track Infrared Sounder (CrIS): Radiometric and Spectral Performance, Hank Revercomb et al., Ninth Annual Symposium on Future Operational Environmental Satellite Systems, 93<sup>rd</sup> AMS Annual Meeting, 5-10 January 2013, Austin, TX. (extended abstract)

The Cross-track Infrared Sounder (CrIS) on Suomi NPP: Quality Assurance Study, Daniel DeSlover et al., poster number 299, Ninth Annual Symposium on Future Operational Environmental Satellite Systems, 93<sup>rd</sup> AMS Annual Meeting, 5-10 January 2013, Austin, TX. (extended abstract)

Suomi NPP/JPSS Cross-track Infrared Sounder (CrIS): Non-linearity Assessment and On-Orbit Monitoring, Robert Knuteson et al., poster number 301, Ninth Annual Symposium on Future Operational Environmental Satellite Systems, 93<sup>rd</sup> AMS Annual Meeting, 5-10 January 2013, Austin, TX. (extended abstract)

Suomi NPP/JPSS Cross-track Infrared Sounder (CrIS): Calibration Validation With The Aircraft Based Scanning High-resolution Interferometer Sounder (S-HIS), Joe K. Taylor et al., poster number 695, Ninth Annual Symposium on Future Operational Environmental Satellite Systems, 93<sup>rd</sup> AMS Annual Meeting, 5-10 January 2013, Austin, TX. (extended abstract)

Calibration/Validation of CrIS on Suomi-NPP: Intercalibration with AIRS, IASI, and VIIRS, David C. Tobin et al., poster number 700, Ninth Annual Symposium on Future Operational Environmental Satellite Systems, 93<sup>rd</sup> AMS Annual Meeting, 5-10 January 2013, Austin, TX. (extended abstract)

Results of calibration/validation efforts for the cross track Infrared Sounder on Suomi NPP, David Tobin et al., Third IASI Conference, 4-9 February 2013, Hyeres, France. (presentation)

Analysis of Suomi NPP Cross-track Infrared Sounder (CrIS) Onboard Digital Filtering and Decimation, Joe Taylor et al., Third IASI Conference, 4-9 February 2013, Hyeres, France. (poster)



## 17.2. VIIRS Radiance Calibration/Validation

**CIMSS Task Leader: Chris Moeller**

**CIMSS Support Scientist: Dan LaPorte**

**NOAA Collaborator: Changyong Cao**

**NOAA Long Term Goals**

- Climate Adaptation and Mitigation

**NOAA Strategic Goals**

- Understand climate variability and change to enhance society's ability to plan and respond

**CIMSS Research Themes**

- Satellite Sensors and Techniques

### Proposed Work

This task supports expert participation in VIIRS pre- and post-launch performance evaluation as follows:

1. SNPP VIIRS Performance and EDR Impact Assessments:
  - Implementing Cal/Val task network assignments (RAD-01, RAD-04, RAD-12A,B), including beneficial modifications to strategy that may become evident in the SNPP post-launch era;
  - Performance analyses and reports on those Cal/Val tasks assigned to UW-Madison. These include tasks on radiometric, spectral and HAM performance;
  - On-going review of VIIRS performance through VIIRS data inspection using McIDAS to identify, isolate and characterize anomalous performance in all VIIRS bands;
  - Monitor SNPP VIIRS spectral performance, including RTA mirror degradation anomaly impact on VIIRS RSR. Update RSR as needed;
  - Strategies for mitigation of performance anomalies as revealed in post-launch era of SNPP;
  - Support LUT updates as needed in coordination with the VIIRS instrument lead;
  - Direct interaction with EDR teams (land, ocean, cloud/atmosphere) to communicate VIIRS SDR performance anomalies, identify VIIRS SDR performance anomalies in the context of EDR performance, and plan effective mitigation strategies when needed;
  - As government team POC for spectral, continue to manage VIIRS RSR products in coordination with STAR and to support science community use of VIIRS RSR;
  - Work with STAR and NIST on a feasibility study to explore the use of high altitude aircraft based measurements to characterize lunar irradiance. This effort also supports preparation for J1 VIIRS on-orbit assessment;
  - Participation in review of performance analyses and reports for non-UW-Madison Cal/Val tasks
2. Preparation for J1 VIIRS Pre-Launch Test Program:
  - Participation in joint government and industry J1 GSE working group;
  - Vetting and recommending changes to the proposed J1 VIIRS test program with an emphasis on spectral characterization; and
3. Participation on VIIRS SDR and Technical teams and in all associated activities:
  - Weekly SDR Team and Technical Team meetings, and
  - Weekly SDR CalVal Leads meetings.



## Summary of Accomplishments and Findings

The reporting period includes the onset of the in-orbit intensive Cal/Val (ICV) phase for the SNPP VIIRS instrument as well as performance reviews to assess “Beta” and “Provisional” status for SDR. The spectral characterization of VIIRS continued to be a primary focus, including the influence of the Rotating Telescope Assembly (RTA) mirror degradation anomaly on reflective solar band (RSB) spectral performance. Progress towards J1 VIIRS test readiness was also achieved. Participation on the VIIRS SDR team was also supported.

### ***SNPP VIIRS Relative Spectral Response (RSR) Characterization***

The SNPP VIIRS spectral characterization has undergone one update (May, 2012) with a second update currently in process (DR4971). In May 2012, the VIIRS SDR RSR LUT was updated with the Northrop Grumman (NG) October 2011 RSR release. This update replaced the at-launch RSR which were based upon the NG December 2010 RSR release. Improvements in the October 2011 release included the adoption of the Govt. team final spacecraft level RSR release for VisNIR bands (replacing a preliminary release), an update to the laboratory water vapor correction for band M9 (i.e., better removal of water vapor contamination from the RSR), and improved filtering of low quality response in the out-of-band region of each band. Separately, the Govt. team DNB RSR analysis was also updated using best quality pre-launch test data collects to better capture spectral performance of this band. All of these RSR products are available to the general science community (<https://cs.star.nesdis.noaa.gov/NCC/SpectralResponseVIIRS>).

A second update to VIIRS SDR RSR LUT is currently in progress (DR4971). The spectral performance of VisNIR and SWIR bands has been undergoing continuous modulation on-orbit due to the RTA mirror degradation anomaly (tungsten contamination). Wisconsin has worked with VCST and Aerospace elements to track the spectral performance of these bands over time. A VCST physical model is serving as the basis for modeling the effect of the tungsten contaminant and predicting spectral impact. Using an assumption that evolution of the on-orbit F factors (corrected for SD changes) is entirely due to RTA mirror throughput degradation, the spectral impact of the RTA mirror degradation has been transferred to the VIIRS RSR and a preliminary “modulated” RSR product was released to the VIIRS community for their testing purposes in October 2012. In general, signal in the red and near infrared spectral regions has been diminished while the blue spectral region is unaffected, resulting in a relative spectral performance change. The impact of this modulation on TOA spectral radiances has been estimated using model spectra and found to be within about 0.5% for “typical” earth ocean, grassland, and desert spectra. This impact can be thought of as an addition to the uncertainty budget when validating VIIRS SDR radiances. Additionally, the EDR community testing using the preliminary modulated RSR release has not revealed any undesirable effects from applying modulated RSR. Therefore, an update to the VIIRS SDR RSR LUT is underway under DR4971, using a snapshot Feb 1, 2013 version of the modulated RSR (example in Figure 17.2.1).

As the government team POC (point of contact) on SNPP VIIRS spectral characterization, the U. Wisconsin-Madison (UW-Madison) team is supporting the VIIRS international science community in their use of VIIRS RSRs. Documentation has been generated to travel with all VIIRS RSR releases from the government team and from NG, and W is responding to all inquiries about the pedigree, integrity, and recommended usage of the various generations of VIIRS RSRs. A conference paper has been written on this subject (see Publications, Conferences and Presentations section).



### **Cal/Val Task Tool Implementation**

UW-Madison has assignments for Cal/Val tasks RAD-01, RAD-04, RAD-12(A,B), RAD-18, RAD-20, and RAD-21. Of these, RAD-01, RAD-04, and RAD-12(A,B) are currently supported (RAD-18, RAD-20, and RAD-21 tasks, which are all aircraft related tasks, are not currently supported). The RAD-01, RAD-04, and RAD-12 tasks have been implemented and are operationally collecting VIIRS performance evaluation data on a daily basis. To date, over 1 year of VIIRS-CrIS global comparisons and VIIRS-IASI SNO comparisons have been collected and are being analyzed to reveal VIIRS performance characteristics. These datasets are assessed along with CrIS-IASI, CrIS-AIRS, and MODIS-IASI comparisons collected under separate funding.

### **SNPP VIIRS On-Orbit Performance Evaluation**

SNPP VIIRS reflected solar and thermal emissive bands have exceeded one year of nominal operation. The VIIRS SDR product achieved a “Beta” designation in the 2<sup>nd</sup> quarter of 2012 and is currently under consideration for “Provisional” status. UW-Madison evaluations during the early orbit checkout (EOC) and the follow-on Intensive Cal/Val (ICV) phase have contributed to the body of evidence supporting these designations. Beyond the assigned Cal/Val tasks, UW-Madison has taken an active role in reviewing various aspects of the SNPP VIIRS performance using its McIDAS-X satellite data visualization and analysis software tool to visually inspect and interrogate VIIRS SDR. This data vigilance and the use of other software tools have supported investigations into the following highlighted performance aspects:

- Band M6 saturation – analog (detector) saturation in M6 causes the digital number scale to “fold over” resulting in ambiguous quality data. A mitigation strategy was adopted that raised the out-of-range radiance threshold and flagged all radiances above Lmax;
- Ongoing RTA mirror throughput degradation has driven M6 fold-over events to higher and higher radiance levels. Interrogation of earth scenes now reveals that all fold-over events are occurring above M6 Lmax radiance level. This finding supports the mitigation strategy adopted for M6 fold-over events;
- Band M6 striping has been characterized using earth scenes. The root cause of the striping is associated with detector to detector analog saturation variability, occurring only after analog saturation is reached. This finding suggests that traditional calibration slope and offset adjustments to mitigate striping will not be effective and should not be applied;
- VIIRS-CrIS spectral radiance comparisons reveal excellent calibration performance at typical scenes for bands M13, M15, M16, and I5 with differences < 0.1 K for typical scenes (CrIS does not contain spectral coverage for M12, M14, and I4). These comparisons however also reveal a linear scene temperature dependence for bands M15 and M16. This dependence peaks for cold scene temperatures at about -0.4 K for M15 and about -0.15 K for M16. Band M13 shows a non-linear behavior at cold scenes that suggests that M13 may have a larger cold scene temperature bias than M15 or M16;
- The one year record of VIIRS-CrIS spectral radiance comparisons reveals excellent stability in M13, M15, M16, and I5 radiometric performance (Figure 17.2.2). Any long-term trends that are present are below 10mK/year. This finding also speaks to the remarkable fidelity of the VIIRS (and CrIS) datasets;
- VIIRS on-orbit warmup/cooldown exercises consistently reveal that VIIRS-CrIS comparisons for all bands converge when the VIIRS OBC is operated at ambient temperature. This unexpected finding strongly suggests that some component(s) of VIIRS calibration is biased by operating the OBC at the nominal 292.5 K operational temperature. The calibration adjustment is small (~ 0.1 K) for all bands but nevertheless is highly systematic, suggesting that it may be corrected by a change to the SDR algorithm process and/or LUTs;



- VIIRS-CrIS comparisons indicate that the HAM RVS is well characterized. The comparisons show that scan angle dependence is below 0.1 K. This behavior is also consistent over the on-orbit nominal data collection period;
- VIIRS-IASI SNO comparisons have revealed that band M14 has a cold scene calibration dependence similar to that observed in M15 (Figure 17.2.3). These comparisons also indicate that M12, M13, and I4 all show non-linear scene temperature dependence that can exceed 1 K at the coldest scenes (< 220 K). Relative performance of VIIRS bands as revealed by the relatively small sample of VIIRS-IASI SNO comparisons is being studied for consistency with the patterns revealed by the data rich sample of VIIRS-CrIS comparisons. A consistency within 0.1 K is sought;
- VIIRS-IASI comparisons using in-band only RSR and full RSR indicate that the influence of VIIRS out-of-band leakage in thermal bands is small. The largest effect appears to be in band M13 with an OOB influence at about 0.1 K for cold scenes. Band M15 OOB, with a well characterized OOB leak identified in pre-launch testing, shows an influence of about 50 mK. Band M16, also with a well characterized OOB leak shows an OOB influence of less than 20 mK. These OOB influence findings are currently limited to high latitude SNOs data scenes and may be larger for other global regions. OOB influence in other VIIRS TEB are all below 20 mK level;
- In support of aircraft based validation activities, the eMAS instrument accomplished its maiden flights on the NASA ER-2 in August 2012. The instrument collected data over Lake Tahoe and the Pacific Ocean for evaluation of performance. A correlated noise is present in the data and is being mitigated through a joint effort between the instrument vendor and NASA-Ames;
- The plausibility of using high altitude aircraft platforms to collect lunar calibration measurements has been explored. The NASA ER-2 platform has an uplooking port suitable for a lunar measurement. The Global Hawk platform is expected to be outfitted with wing pods in the near future that may provide an uplooking port. Considerations of aircraft vibration, environmentally controlled space and aircraft stability are all important to achieving a quality lunar calibration measurement. These findings were reported at the Lunar Calibration Workshop in May 2012; and
- Lessons learned from VIIRS Flight 1 spectral testing have been incorporated into J1 VIIRS spectral test program. Upgrades to hardware and operation of the SpMA are underway; plans for the use of the NIST T-SIRCUS measurement equipment are also under review.

In addition to these performance investigations, UW-Madison has participated in the review of all other SNPP VIIRS performance aspects through regular VIIRS Technical Team and SDR Team telecon discussions.

### ***Preparation for J1 VIIRS Pre-launch Test Program***

- The SpMA GSE must be utilized in the J1 RSB spectral test program to cover full range OOB spectral measurements for SWIR bands. Wisconsin supports developing a strategy to use NIST's T-SIRCUS GSE to measure VisNIR RSB full spectral range under flood illumination using the TMC with a small integrating sphere for RSR and then using a large (100 cm) sphere to establish ASR. This spectral testing should be supplemented with strategic cross talk testing using a slit reticle at wavelengths wherever the flood illumination indicates possible cross talk features. Wisconsin also supports using T-SIRCUS to measure in-band RSR for SWIR bands and, if off the critical path, measuring SWIR OOB to the extent of the T-SIRCUS spectral range.

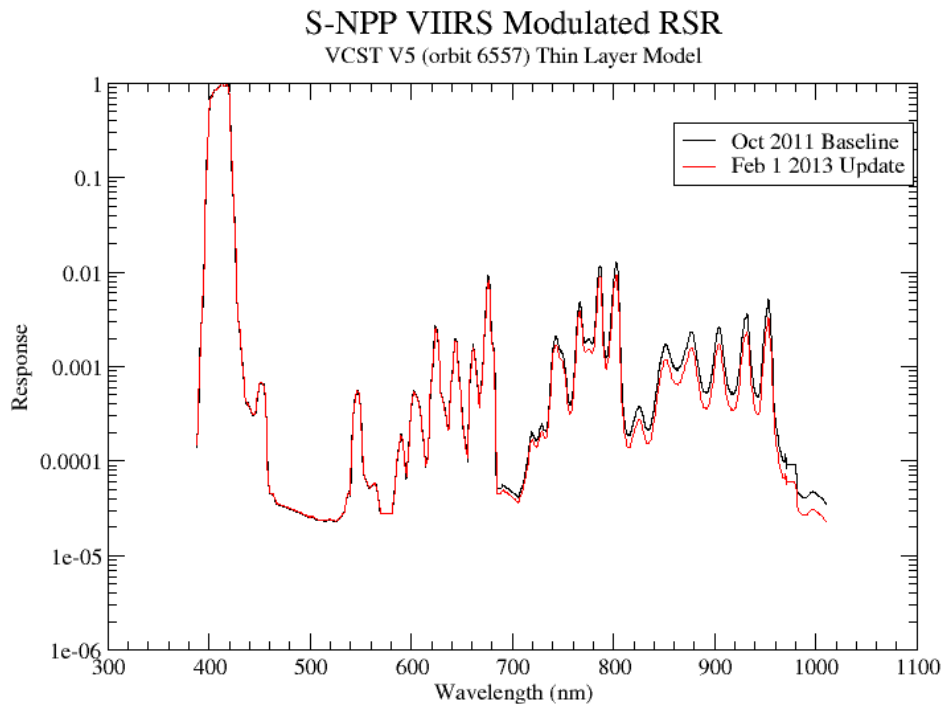




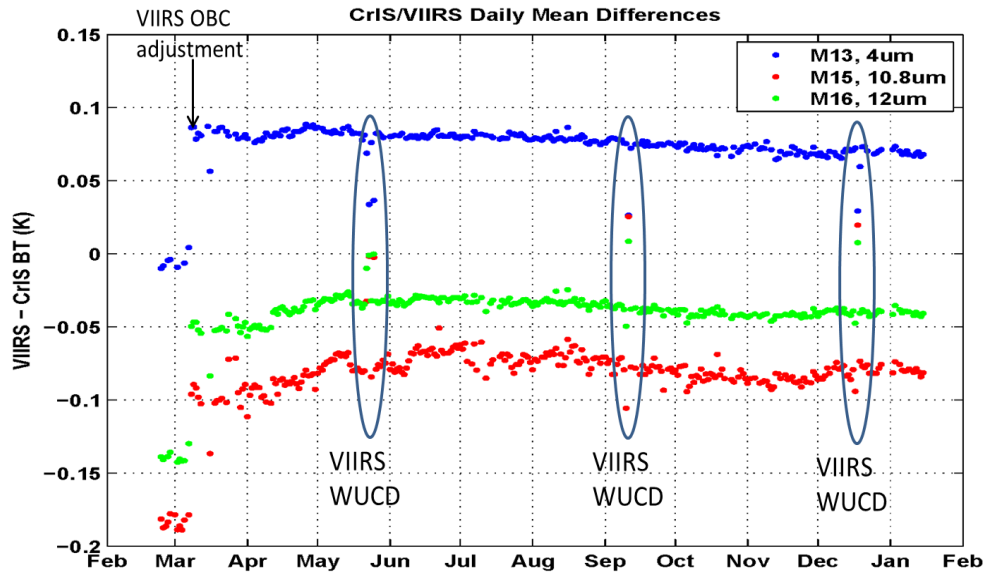
- Raytheon’s proposal for refurbishment/upgrades of the SpMA GSE has been reviewed. It includes adjustments to the J1 test procedure, replacement of slit jaws governing the spectral bandpass and spatial footprint of the SpMA output, new capabilities for source bulb alignment and other adjustments. Raytheon is also reviewing procedure/setup to obtain real time source output measurements during spectral test data collection. Wisconsin supports implementation of this proposal. Wavelength accuracy requirements for J1 spectral tests have also been reviewed using model spectra to estimate the sensitivity of VIIRS TOA earth scene reflectance to RSR wavelength bias.
- A recommendation has been provided to industry to expand the dynamic range of band M6 for J1 VIIRS. This recommendation will be implemented on the J1 VisNIR spare focal plane. If the J1 VisNIR spare focal plane is not utilized in J1 VIIRS, then it will become the primary VisNIR focal plane for J2. This recommendation will mitigate M6 fold-over occurrences by pushing them to radiance levels well above M6 LMAX specification of 41 W/m<sup>2</sup> sr um.

### **VIIRS SDR Team Participation**

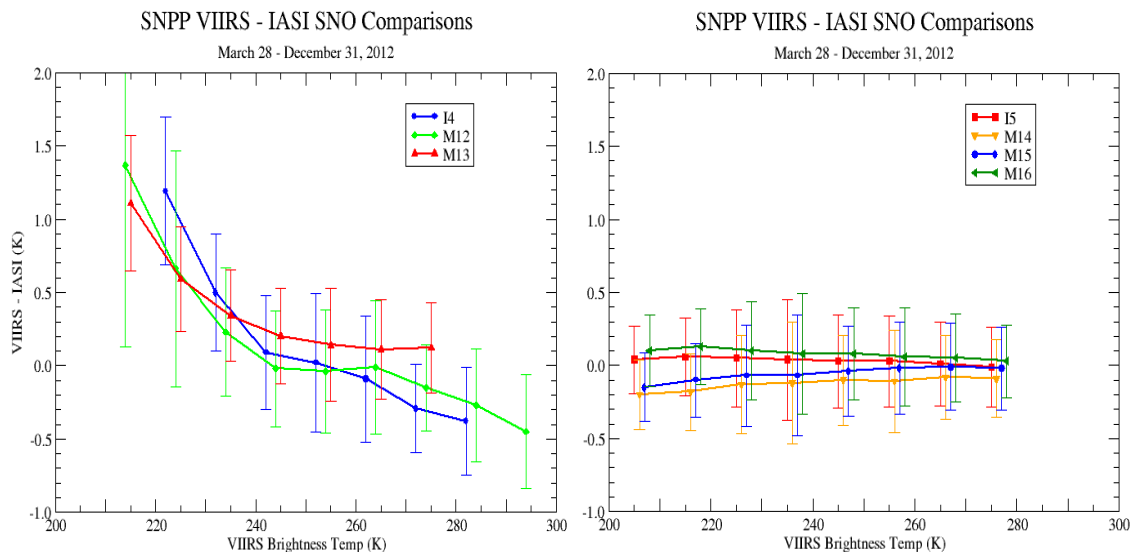
- Weekly SDR Team telecons are conducted to review VIIRS performance in the presence of a broad VIIRS audience, including industry, NOAA, and government (SDR and EDR Teams). Wisconsin has presented on VIIRS SDR performance progress noted above and has participated in reviews of performance evaluations presented by other elements of the SDR Team.
- Wisconsin is participating in weekly SDR Leads and SDR Technical Team telecons presenting on Wisconsin investigations into SDR performance and reviewing investigations by other elements of the team in a tabletop format.



**Figure 17.2.1.** SNPP VIIRS band M1 showing baseline and modulated (Feb 1 2013) RSR. VIIRS RSB RSR are modulated by darkening of the VIIRS RTA mirrors due to tungsten contamination. This causes a noticeable relative reduction in M1 response beyond 600nm.



**Figure 17.2.2.** VIIRS-CrIS spectral radiance differences from March 2012 – Jan 2013 demonstrating excellent stability in VIIRS (and CrIS) radiometric calibration. VIIRS calibration was adjusted in March 2012, improving the comparison to CrIS. VIIRS Warmup-Cooldown (WUCD) events are planned blackbody (OBC) exercises and do not represent an anomaly but do demonstrate a dependence of VIIRS calibration on the operating temperature of the OBC.



**Figure 17.2.3.** VIIRS-IASI SNO average differences and standard deviations for MWIR bands (left) and LWIR bands (right). Data points for each band slightly offset on x-axis to declutter. VIIRS MWIR band differences exhibit a pronounced scene temperature dependence that exceeds 1K. VIIRS LWIR band differences suggest a small scene temperature dependence of about 0.2 K in M15, and closer to 0.1K in M14 and M16. Mitigation of this systematic behavior is under review.



## **Publications, Conferences and Presentations**

Moeller, C., J. McIntire, T. Schwarting, D. Moyer, and J. Costa “Suomi NPP VIIRS Spectral Characterization: Understanding Multiple Releases.” SPIE Proc. 8510, 85101S, doi: 10.1117/12.980437 (2012).

Moeller, C. “Early NPP VIIRS SDR Performance: Univ. Wisconsin.” Presentation at the NPP VIIRS SDR Product Review, April 5, 2012. Camp Springs, MD.

Moeller, C. “S-NPP VIIRS SDR Performance: Univ. Wisconsin.” Presentation at the S-NPP SDR Product Review, October 23-24, 2012. College Park, MD.

Moeller, C., D. Tobin, N. Lei, J. McIntire, and T. Schwarting. “SNPP VIIRS Spectral Status.” Presentation at the SNPP VIIRS Calibration Workshop, January 22, 2013. Lanham, MD.

## **17.3. CrIMSS Post Launch EDR Assessment**

**CIMSS Task Leader: R. Knuteson**

**CIMSS Support Scientists: M. Feltz, J. Roman**

**NOAA Collaborators: C. Barnet, N. Nalli**

**NOAA Long Term Goals**

- Climate Adaptation and Mitigation
- Weather-Ready Nation

**NOAA Strategic Goals**

- Serve society’s needs for weather and water
- Provide critical support for the NOAA mission

**CIMSS Research Themes**

- Satellite Meteorology Research and Applications
- Satellite Sensors and Techniques

## **Proposed Work**

The CrIMSS products from Suomi NPP will provide high vertical resolution and accuracy temperature and moisture profiles with global coverage. The traditional way for assessing the sounding products is to compare soundings with conventional radiosonde observations. However, radiosondes are only available at 00 UTC and 12 UTC over land, it is very important to assess the NPP sounding products with quality measurements other than conventional radiosondes. CIMSS scientists have extensive experience with the development of best quality validation dataset from the Department of Energy Atmospheric Radiation Measurement (ARM) program. In addition, new types of measurements from ground-based GPS receivers and COSMIC Radio Occultations provide accurate water vapor and temperature information for sounding assessment. We propose the use of collocated ARM site quality in-situ measurements as well as the ground-based GPS column water vapor measurements to assess the NPP water vapor sounding product, and the high quality COSMIC RO temperature profiles will be used to assess the NPP temperature sounding product.

The three sub-tasks for this project are described below. Also listed are recent publications/presentations summarizing results from previous funding periods. The project overview and progress reports were presented at the June 2010 and July 2011 Sounder Operational Algorithm Team (SOAT) meetings in Washington, D.C.



### **Total Column Water Vapor Validation Using MWR and GPS Stations**

We have published detailed analyses (Bedka et al., 2010) of the accuracy of AIRS total column water vapor products using ground based microwave radiometer (MWR) validation data from the DOE ARM sites. We have extended this analysis from beyond the three ARM sites to include the NOAA SuomiNet and Wind Profiler Demonstration Network (WPDN) ground-based GPS sensors which provide much greater geographic coverage and dozens of sites around the world with similar accuracy. We are developing methods for CrIMSS validation of total water vapor using AIRS L2 products that take into account the station elevation in regional assessments. These methods will be applied to CrIMSS EDR products when these become available.

### **Water Vapor Profile Validation Using the ARM RAMAN LIDAR**

Continuously operating Raman Lidars can provide a valuable resource for the validation of satellite derived water vapor vertical profiles, particularly in regard to exact time coincidence (compared to radiosondes) and in the validation of upper tropospheric water vapor. The DOE ARM Raman lidar mixing ratio profile has been calibrated using the total column water vapor from a coincident microwave radiometer (MWR) to achieve good absolute accuracy in the vertical profile. We propose here to use the existing Raman Lidar products from the ARM Southern Great Plains site to assess the accuracy of the CrIMSS water vapor profiles. Preliminary assessment of AIRS and NOAA IASI retrievals of upper level water vapor have been used to develop the validation methodology. A new Raman Lidar has been installed at the DOE ARM site in Darwin, Australia which will be incorporated into the validation of CrIMSS in subsequent years. These Raman Lidar profiles will be used to fill in the gaps in the seasonal coverage of the special radiosonde launches and help quantify errors in capturing the actual diurnal cycle. The profile statistics of water vapor will also be used to validate the CrIMSS water vapor product stability over long time periods.

### **Temperature Profile Validation Using GPS**

This effort involves the use of temperature products derived from GPS occultation to assess the CrIMSS temperature profiles. Zonal global and regional statistics on vertical temperature deviations between the AIRS, IASI, and CrIMSS temperature soundings and the COSMIC and EPS-METOP GPS profiles are proposed. An area of emphasis will be the error assessment near the tropopause where the IR sounder temperature retrieval performance is degraded but the GPS occultation profile is considered to have excellent absolute accuracy. Methods to validation the CrIMSS temperature profiles have been developed to complement the radiosondes at the ARM sites in particular. These methods will be applied to CrIMSS product accuracy assessment during this performance period.

### **Summary of Accomplishments and Findings**

Knuteson EDR accomplishments included; 1) IDPS version 15 October Mx version upgrade evaluation, 2) AMS annual meeting, and 3) Contribution to CrIMSS Provisional Status review.

#### **1. IDPS Mx5.3 – Mx6.3 version update evaluation**

On 15 October 2012, IDPS upgraded software from Mx5.3 to Mx6.3. This version update included important changes for the CrIMSS product, esp. an updated ATMS scan bias correction. We were able to assess the impact of this change on bias and RMS using a comparison of the CrIMSS 42/22 IDPS product with the COSMIC network GPS RO dry temperature for the first and last ten days of the October. The result is summarized in Figure 17.3.1. A comparison of AIRS v5 L2 products with the COSMIC GPS RO dry temperature was also performed for reference.

#### **2. Conference Papers**

A poster/conference paper on CrIMSS validation using GPS RO by undergraduate in



- Austin, TX the first week of January 2013 (Feltz et al., 2013). Two conference papers were presented by graduate student Jacola Roman that included assessment of precipitable water vapor from AIRS and CrIMSS (Roman et al., 2012a,b).
3. *Contribution to the CrIMSS provisional review meeting January 2013*  
In response to a request, the figures on the M. Feltz AMS poster comparing CrIMSS IDPS products to COSMIC GPS RO dry temperature in the pressure range 30 mb – 300 mb were provided to Chris Barnet for inclusion in the justification for moving from beta to provisional status. At altitudes below 300 mb the presence of water vapor causes a bias error in the GPS RO dry temperature product. At altitudes above 30 mb the uncertainty in the GPS RO product increases due to uncertainties in the ionospheric correction. For these reasons the CrIMSS validation is restricted to the 30-300 mb range for AVTP. Corresponding results from AIRS and COSMIC were also provided as reference. The following figure summarizes the impact on bias, RMS, and standard deviation caused by the Mx5.3 to Mx6.3 update that occurred on 15 October 2012. It is readily apparent from the improvement in the bias and RMS that the CrIMSS product has achieved the requirements to be declared provisional, i.e., suitable for evaluation in the EDR Cal/Val activities. Planned software upgrades are expected to further improve the statistical performance and yield of the CrIMSS product.

### **Publications and Conference Reports**

Roman, J.; Ackerman, S.; Knuteson, R.; Revercomb, H.; Smith, W. and Tobin, D., 2012: Using AIRS and AMSR-E to assess the precipitable water vapor in Global Climate Models (GCMs) with regional validation in SuomiNET and NWP re-analysis. IRS 2012: International Radiation Symposium, Berlin, Germany, 6-10 August 2012.

<http://meetingorganizer.copernicus.org/IRS2012/IRS2012-117.pdf>

Roman, J., R. O. Knuteson, S. A. Ackerman, H. E. Revercomb, W. Smith, E. Weisz, 2012: Using Regional Validation from SuomiNet, AMSR-E, and NWP Re-analysis to Assess the Precipitable Water Vapor from AIRS and CrIS for Detecting Extreme Weather Events, AGU Fall Meeting, 3-7 December 2012, San Francisco, CA.

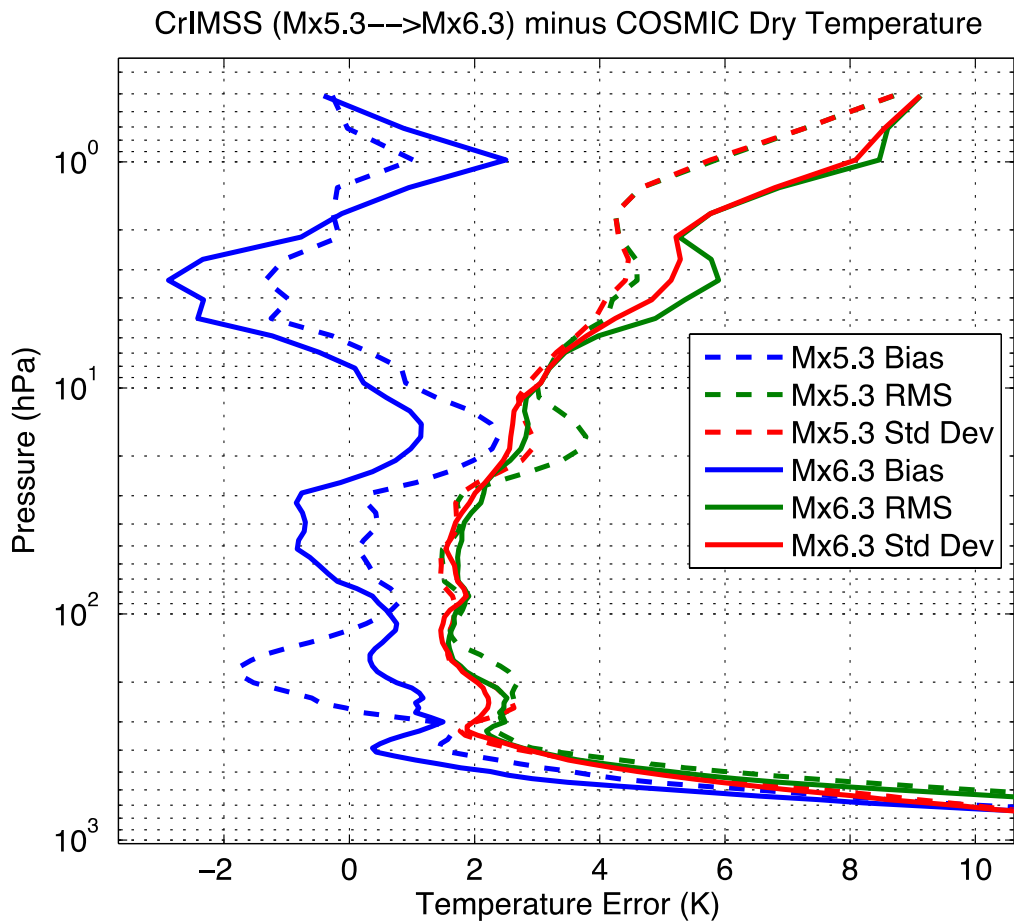
<http://fallmeeting.agu.org/2012/eposters/eposter/a33m-0324/>

Feltz, M., R. O. Knuteson, H. Revercomb, D. Tobin, and S. Ackerman, 2013: Validation of Temperature Profile Environmental Data Records (EDRs) from the Cross-Track Infrared Microwave Sounding Suite (CrIMSS) Using COSMIC Dry Temperature Profiles, Ninth Annual Symposium on Future Operational Environmental Satellite Systems, 93rd Annual AMS Meeting 5-10 January 2013, Austin, TX.

<https://ams.confex.com/ams/93Annual/webprogram/Paper216036.html>

### **References**

Bedka, Sarah; Knuteson, Robert; Revercomb, Henry; Tobin, David, and Turner, David, 2010. An assessment of the absolute accuracy of the Atmospheric Infrared Sounder v5 precipitable water vapor product at tropical, midlatitude, and arctic ground-truth sites: September 2002 through August 2008. *Journal of Geophysical Research*, **115**, no.D17, 2010, pdoi:10.1029/2009JD013139.



**Figure 17.3.1.** Impact on the AVTP bias (blue), RMS (green), and standard deviation (red) of the official CrIMSS IDPS product relative to coincident matchups from the COSMIC GPS RO network from the change in IDPS version Mx5.3 (dashed) to Mx6.3 (solid). The bias and RMS are considerably improved in the 30 mb to 300 mb range for which the COSMIC GPS RO is most accurate.

Feltz, M., R. Knuteson, D. Tobin, S. Ackerman, H. Revercomb, and A. Reale, 2012: Methodology for the Validation of Temperature Profile Environmental Data Records (EDRs) From the Cross-Track Infrared Microwave Sounding Suite (CrIMSS): Experience with GPS Radio Occultation From COSMIC, AMS Annual Meeting, New Orleans, LA, 22-26 January 2012. <http://ams.confex.com/ams/92Annual/webprogram/Paper200494.html>

Knuteson, R., D. Tobin, A. Sorce, J. Roman, S. Ackerman, H. Revercomb, and D. D. Turner, 2012: Methodology for the Validation of Water Vapor Profile Environmental Data Records (EDRs) From the Cross-Track Infrared Microwave Sounding Suite (CrIMSS): Experience with the DOE ARM Water Vapor Raman Lidar, AMS Annual Meeting, New Orleans, LA, 22-26 January 2012. <http://ams.confex.com/ams/92Annual/webprogram/Paper200492.html>

Roman, Jacola A., Robert O. Knuteson, Steven A. Ackerman, David C. Tobin, Henry E. Revercomb, 2012: Assessment of Regional Global Climate Model Water Vapor Bias and Trends Using Precipitable Water Vapor (PWV) Observations from a Network of Global Positioning



Satellite (GPS) Receivers in the U.S. Great Plains and Midwest. *J. Climate*, **25**, 5471–5493. doi: <http://dx.doi.org/10.1175/JCLI-D-11-00570.1>

#### **17.4. CrIMSS EDR Cal/Val: ARM Site Support**

**CIMSS Task Leader: Dave Tobin**

**CIMSS Support Scientists: Lori Borg, Robert Knuteson**

**NOAA Collaborators: Nicholas Nalli, Tony Reale, Chris Barnett**

##### **NOAA Long Term Goals**

- Climate Adaptation and Mitigation
- Weather-Ready Nation

##### **NOAA Strategic Goals**

- Serve society's needs for weather and water
- Understand climate variability and change to enhance society's ability to plan and respond
- Provide critical support for the NOAA mission

##### **CIMSS Research Themes**

- Satellite Meteorology Research and Applications
- Satellite Sensors and Techniques

#### **Proposed Work**

The proposed work is designed to prepare for and conduct efforts for the critical validation of NPP CrIMSS atmospheric temperature and water vapor retrieved profiles and observed infrared radiances. The assessment of soundings on the 1K/km level and the establishment of a long term set of well-characterized sounding products requires accurate and on-going validation data. The Atmospheric Radiation Measurement (ARM) program field sites provide such data. In this arrangement, radiosondes are launched from the ARM sites coincident with the satellite overpasses of the sites, and analysis is performed by UW-Madison personnel to compare the radiosonde and CrIMSS EDR products to assess the accuracy of the satellite products. Previously for AIRS and IASI, best estimates of the atmospheric state and surface properties at the satellite overpass times were produced via a similar collaborative effort between NASA and ARM. This work was a fundamental, integral, and cost-effective part of the EOS validation effort and provided critical accuracy assessments of the AIRS temperature and water vapor soundings. Further science justification and details of the approach for this effort are described in detail in Tobin et al., 2006. This effort is anticipated to be repeated throughout the NPP mission life into FY15.

#### **Summary of Accomplishments and Findings**

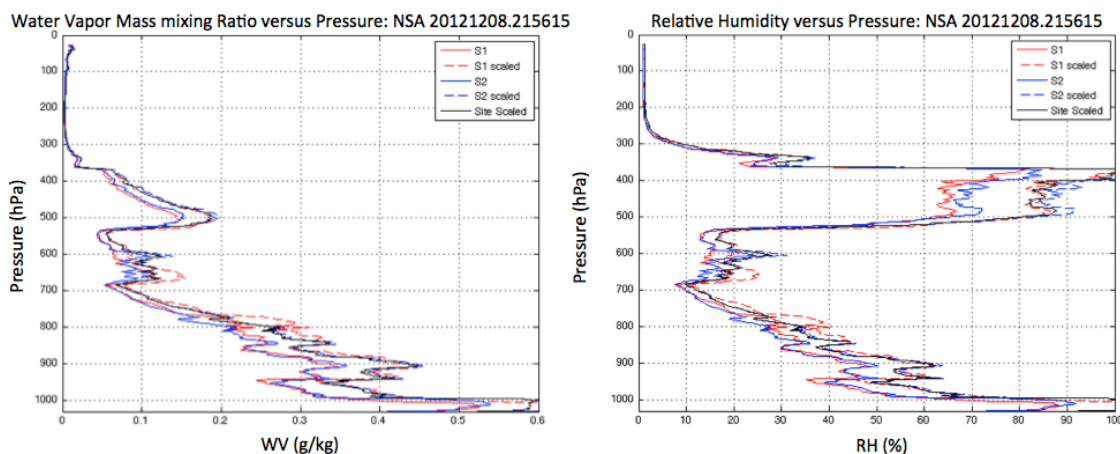
This year, the ARM effort involved launching Vaisala RS-92 radiosondes from three of the ARM field sites, including the Southern Great Plains (SGP), North Slope of Alaska (NSA) and Tropical Western Pacific (TWP) Manus island sites. After the initial checkout of the ATMS and CrIS SDRs in 2012, the dedicated ARM launches started in July. This effort included two launches per overpass at the SGP and NSA sites, and one launch per overpass at the TWP Manus site, with the goal of collecting data for a total of 90 overpasses at each site. To date, 90 sonde pairs were completed at NSA, 89 sonde pairs at SGP, and 61 sondes at TWP. (Launches were put on hold pending resolution of a contract issue between ARM and NOAA. The original contract defined a period of performance ending on January 14, 2013. Even though the funding was in place to complete the sondes, launches were put on hold until the issue over the period of performance



was resolved. Launches resumed at the TWP Manus site on March 15, 2013 and are projected to be completed by mid June 2013.)

On December 26, 2012, the version-0 (v0p0) ARM best estimate product was created and made available to the project. This product can be found at:  
[https://www.dropbox.com/s/t52q9cao4wzk1go/armbe\\_v0p0.tar.gz](https://www.dropbox.com/s/t52q9cao4wzk1go/armbe_v0p0.tar.gz)

Specific information on what is contained in the v0p0 best estimate sonde product can be found in the README.txt file located within the above tar file. A sample best estimate product is shown in Figure 17.4.1.



**Figure 17.4.1.** A sample ARM best estimate water vapor product, shown as mass mixing ratio and relative humidity, for an NPP overpass of the NSA site at 21:56 UTC on 8 Dec 2012. The two radiosondes (S1 and S2) and the v0 best estimate product are shown.

Our current efforts include 1) on-going coordination of the sonde launch schedule and logistics with the ARM personnel, 2) refinement of the best estimate products for the 2012 launches using more frequent information on the time change of the atmospheric state to interpolate between the two dedicated radiosondes and inclusion of cloud and surface characterization data, and 3) evaluation of the CrIMSS EDRs (and related CrIS sounding products such as from NUCAPS or other algorithms/groups) via comparisons with the ARM best estimate products.

## References

Tobin D. C., H. E. Revercomb, R. O. Knuteson, B. M. Lesht, L. L. Strow, S. E. Hannon, W. F. Feltz, L. A. Moy, E. J. Fetzer, T. S. Cress (2006), Atmospheric Radiation Measurement site atmospheric state best estimates for Atmospheric Infrared Sounder temperature and water vapor retrieval validation. *J. Geophys. Res.*, **111**, D09S14, doi:10.1029/2005JD006103.

## 17.5. Suomi NPP VIIRS Aerosol IP/EDR Evaluation

**CIMSS Task Leader: Robert Holz**

### NOAA Long Term Goals

- Climate Adaptation and Mitigation
- Weather-Ready Nation





## **NOAA Strategic Goals**

- Serve society's needs for weather and water
- Understand climate variability and change to enhance society's ability to plan and respond
- Provide critical support for the NOAA mission

## **CIMSS Research Themes**

- Satellite Meteorology Research and Applications
- Satellite Sensors and Techniques

## **Summary of Accomplishments and Findings**

### ***Validation Datasets***

The VIIRS AOT and Ångström exponent products have been compared with aerosol products derived from the Moderate Resolution Imaging Spectroradiometer (MODIS) onboard the NASA Earth Observing System (EOS) satellite (Aqua).

The MODIS aerosol product used in the comparisons is the Collection 5 Dark Target product over land and ocean which has been in production for a dozen years, has undergone continuous evaluation during this time and is considered to be well characterized product with error bars, which are stated to be  $\pm 0.03 \pm 0.05$  AOT over ocean and  $\pm 0.05 \pm 0.15$  AOT over land. The advantage of the MODIS comparisons is the broad regions that can be covered and the vast number of collocations.

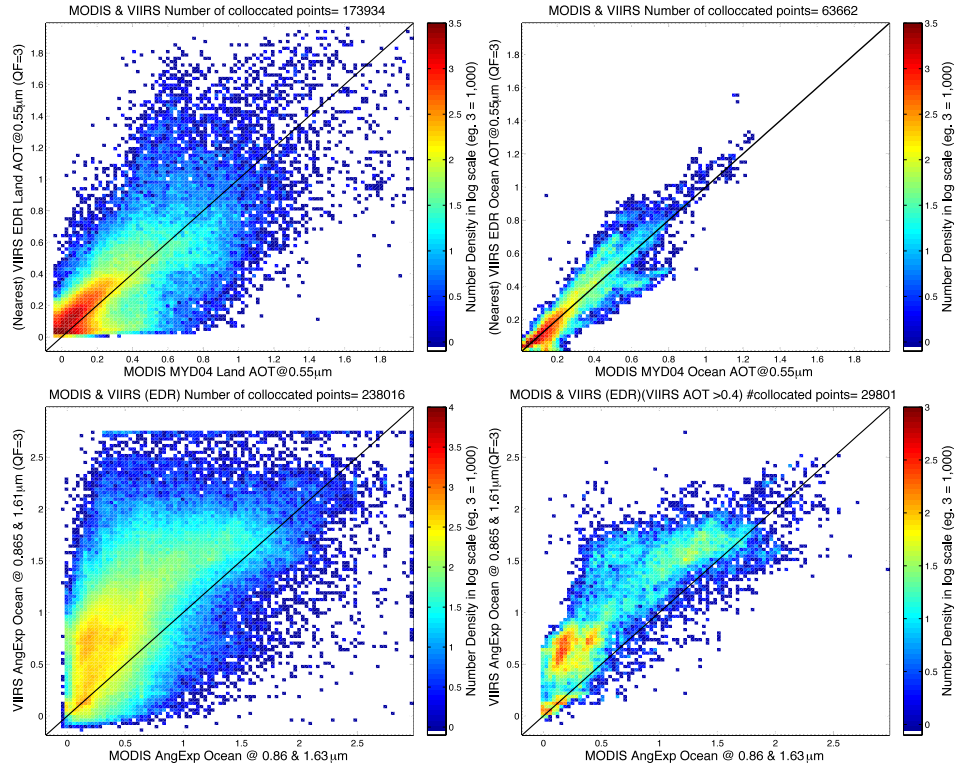
### ***Beta Period Validation***

The validation of the VIIRS aerosol products began on 2 May 2012, about six months after the launch of Suomi NPP. The six-month delay allowed the primary input parameters used by the aerosol algorithm spectral reflectance (SDRs) and cloud mask products (VCM) be characterize and refined. We are currently validating the VIIRS EDRs using the MODIS aerosol product, using these filtering criteria:

- VIIRS and MODIS retrievals are collocated within 5 minutes of observation time; match-ups are found for days of year 123, 126, 128, 131, 134, 136, 137, 139, 142, 144, 147, 150, 152 and 153 within May 2 – June 2, 2012;
- MODIS AOT over Land and Ocean are filtered with MODIS cloud mask QA (Best) to select data with Cloud Fraction 0 to 30%;
- MODIS AOT is filtered with the MODIS Quality Assurance to select collocations only with the quality mix recommended by the MODIS aerosol team; and
- The collocation seeks high quality VIIRS's nearest neighbor AOT that falls within the MODIS L2 10km product footprint.

Product evaluation began with data collected on 2 May 2012 to Jun 2 are shown in Figure 17.5.1.

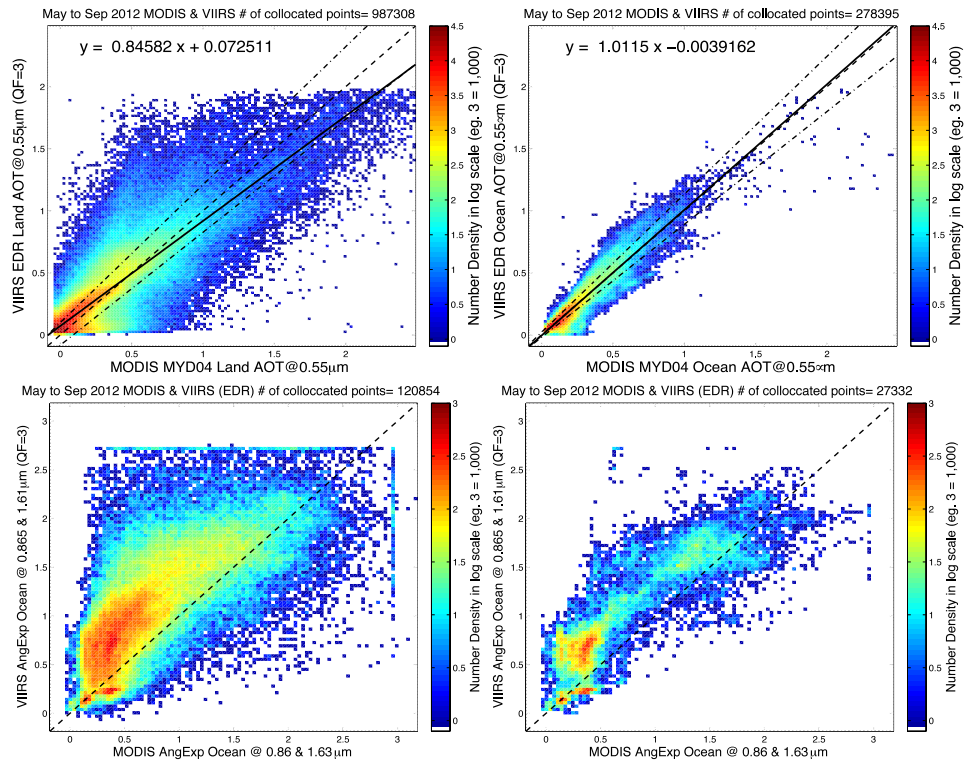
In the Beta period, certain specific issues were identified such as the AOT product over land was biased high against Aqua MODIS AOT, and the over land Ångström exponent demonstrated little skill (not shown in this report). The high bias in AOT was traced to assumptions of surface reflectance ratios.



**Figure 17.5.1.** Density scatterplots of collocated VIIRS and MODIS AOT at 0.55  $\mu\text{m}$  (top) and 0.865  $\mu\text{m}$ /1.61  $\mu\text{m}$  Ångström exponent (bottom). Left panel AOT for land and right panel AOT for ocean. Right panel Ångström exponent for AOT 550 nm greater than 0.40. Left panel Ångström exponent for all AOT.

Below criteria are the data filtered for the validation:

- The co-located MODIS (L2) and VIIRS (IP/EDR) AOT are match-up in 5 minutes temporal resolution; match-ups are found within May 2 – Sep 30, 2012;
- Both MODIS AOT over land and Ocean are filtered with MODIS Could Fraction (from aerosol cloud mask)= 0;
- MODIS AOT is filtered with the best MODIS Quality Assurance Land and Ocean; and
- Co-locate nearest neighbor VIIRS AOT is filtered with QF=3.



**Figure 17.5.2.** Density scatterplots of collocated VIIRS and MODIS AOT at 0.55 μm (top) and 0.865 μm/1.61 μm Ångström exponent (bottom). Left panel AOT for land and right panel AOT for ocean. Right panel Ångström exponent for AOT 550 nm greater than 0.40. Left panel Ångström exponent for all AOT. Period of validation May to September 2012.



**Table 17.5.1.** Statistical analysis of MODIS and VIIRS (IP/EDR) AOT over Land and ocean; ( $\Delta\tau$ ) =VIIRS AOT – MODIS AOT; (a) VIIRS (EDR) AOT over Land (b) VIIRS (IP) AOT over land (c) VIIRS (EDR) AOT over ocean (d) VIIRS (IP) AOT over ocean

	# of Sample	One standard deviation ~ 68 % of $\Delta\tau$ falls within	Mean ( $\Delta\tau$ )	STD ( $\Delta\tau$ )	CORR-COEFF (R)	Linear fit equation
May, 2012	a) 173k b) 160k c) 62k d) 63k	$\pm 0.090 \pm 0.10 T_{MODIS}$ $\pm 0.110 \pm 0.10 T_{MODIS}$ $\pm 0.020 \pm 0.10 T_{MODIS}$ $\pm 0.023 \pm 0.10 T_{MODIS}$	0.040 0.039 -0.0017 0.0005	0.1447 0.2059 0.0564 0.0565	0.8024 0.6994 0.9350 0.9334	$y = 0.797x + 0.072$ $y = 0.821x + 0.075$ $y = 0.997x - 0.001$ $y = 1.008x - 0.001$
Jun, 2012	a) 218k b) 180k c) 48k d) 49k	$\pm 0.095 \pm 0.10 T_{MODIS}$ $\pm 0.095 \pm 0.10 T_{MODIS}$ $\pm 0.015 \pm 0.10 T_{MODIS}$ $\pm 0.020 \pm 0.10 T_{MODIS}$	0.0590 0.0640 0.0030 0.0045	0.1210 0.1856 0.0525 0.0553	0.8584 0.7554 0.9581 0.9530	$y = 0.841x + 0.081$ $y = 0.896x + 0.083$ $y = 0.986x + 0.005$ $y = 1.003x + 0.004$
Jul, 2012	a) 215k b) 171k c) 51k d) 52k	$\pm 0.095 \pm 0.10 T_{MODIS}$ $\pm 0.095 \pm 0.10 T_{MODIS}$ $\pm 0.017 \pm 0.10 T_{MODIS}$ $\pm 0.020 \pm 0.10 T_{MODIS}$	0.057 0.057 0.0001 0.0003	0.1122 0.1737 0.0487 0.0509	0.9007 0.8180 0.9549 0.9509	$y = 0.835x + 0.081$ $y = 0.853x + 0.088$ $y = 1.051x - 0.008$ $y = 1.061x - 0.009$
Aug, 2012	a) 222k b) 200k c) 61k d) 64k	$\pm 0.090 \pm 0.10 T_{MODIS}$ $\pm 0.090 \pm 0.10 T_{MODIS}$ $\pm 0.017 \pm 0.10 T_{MODIS}$ $\pm 0.020 \pm 0.10 T_{MODIS}$	0.050 0.049 0.0016 0.0024	0.1143 0.1698 0.0445 0.0469	0.8996 0.8161 0.9472 0.9398	$y = 0.842x + 0.075$ $y = 0.875x + 0.075$ $y = 1.057x - 0.007$ $y = 1.054x - 0.005$
Sep, 2012	a) 157k b) 141k c) 54k d) 56k	$\pm 0.080 \pm 0.10 T_{MODIS}$ $\pm 0.090 \pm 0.10 T_{MODIS}$ $\pm 0.022 \pm 0.10 T_{MODIS}$ $\pm 0.025 \pm 0.10 T_{MODIS}$	0.035 0.032 -0.0129 -0.0121	0.1115 0.1720 0.0500 0.0516	0.8802 0.7902 0.8778 0.8469	$y = 0.927x + 0.046$ $y = 1.013x + 0.029$ $y = 0.955x - 0.006$ $y = 0.936x - 0.002$
May to Sep 2012	a) 987k b) 853k c) 278k d) 287k	$\pm 0.090 \pm 0.10 T_{MODIS}$ $\pm 0.095 \pm 0.10 T_{MODIS}$ $\pm 0.020 \pm 0.10 T_{MODIS}$ $\pm 0.022 \pm 0.10 T_{MODIS}$	0.050 0.049 0.0020 0.0009	0.1211 0.1819 0.0510 0.0526	0.8716 0.7780 0.9415 0.9358	$y = 0.846x + 0.073$ $y = 0.882x + 0.072$ $y = 1.011x - 0.004$ $y = 1.020x - 0.004$

## 18. CIMSS Participation in the JPSS Algorithm Continuity Risk Reduction Program for 2012

### 18.1. NOAA Algorithm Continuity – Ice surface Temperature, Concentration, and Characterization

CIMSS Task Leader: Yinghui Liu  
CIMSS Support Scientist: Xuanji Wang



**NOAA Collaborator: Jeffrey Key**

**NOAA Long Term Goals**

- Climate Adaptation and Mitigation
- Weather-Ready Nation

**NOAA Strategic Goals**

- Serve society's needs for weather and water
- Provide critical support for the NOAA mission

**CIMSS Research Themes**

- Satellite Meteorology Research and Applications

**Proposed Work**

The goal of this task is to modify the ice surface temperature (IST), ice concentration, and ice age/thickness (or “characterization”; Wang et al., 2010) algorithms that CIMSS developed for the GOES-R Advanced Baseline Imager (ABI) so that they can be applied to data from the NPP Visible Infrared Imager Radiometer Suite (VIIRS). These and other state-of-the-art products have been developed for the ABI instrument but, due to budgetary considerations, will not initially be generated for GOES-R.

Using these algorithms to generate VIIRS products will bring continuity to the NOAA product suite over time. Equally importantly, the current VIIRS products may not meet the needs of users, so these NOAA-unique products will provide alternatives to the industry-developed VIIRS products. The algorithms are mature and have been extensively tested on Moderate Resolution Imaging Spectrometer (MODIS) and other satellite data, and have been shown to meet the GOES-R requirements for accuracy and precision.

**Summary of Accomplishments and Findings**

GOES-R algorithms are being modified to run using VIIRS data. Differences between ABI and VIIRS must be taken into account, particularly the number and characteristics of the spectral bands. Test data are being acquired. Figure 18.1.1 shows examples of ice surface temperature, thickness, and age retrieved with VIIRS data.

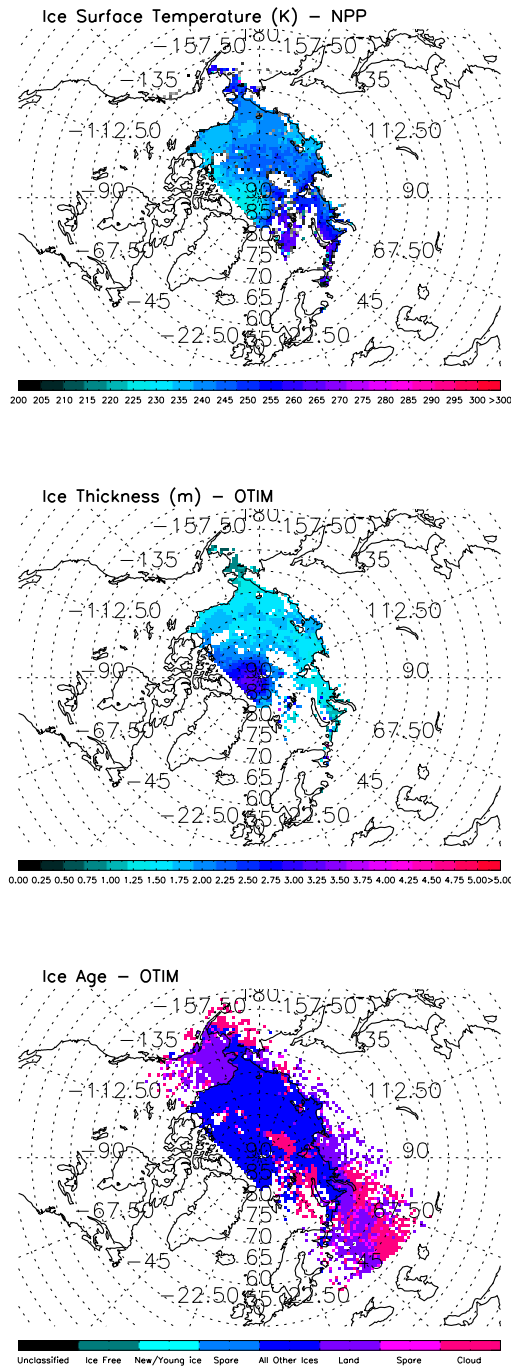
Several case studies have been generated, and results are being compared to current VIIRS products and to products generated with MODIS data. Validation with in situ data will be performed as appropriate.

The process of integrating the algorithms into the GOES-R Algorithm Integration Team's “Framework” has begun. Documents, such as the Algorithm Theoretical Basis Documents (ATBD) that were written for ABI, will be modified accordingly.

A number of design reviews are required for this project. The investigators have prepared for the Critical Design Review (CDR), which will be held in this month (April 2013).

**Publications and Conference Reports**

Wang, X., J. Key, and Y. Liu, 2012: Sea Ice Estimation and Inter-comparisons from Different Satellite Data, 2012 Earth Observation and Cryosphere Science, 13 - 16 November 2012, Frascati, Italy.



**Figure 18.1.1.** Sea ice surface temperature (top), OTIM retrieved sea ice thickness (middle) and age (bottom) with VIIRS data for the date of March 4, 2012 under clear-sky condition.

### References

Wang, X., J. Key, and Y. Liu, 2010: A thermodynamic model for estimating sea and lake ice thickness with optical satellite data. *J. Geophys. Res.-Oceans*, **115**, C12035, doi:10.1029/2009JC005857.



## 18.2. Transition of GOES-R AWG Cloud Algorithms to VIIRS/JPSS

**CIMSS Task Leader: Andi Walther**

**CIMSS Support Scientist: William Straka, Denis Botambekov, Lisha Roubert**

**NOAA Collaborator: Andrew Heidinger**

### **NOAA Long Term Goals**

- Climate Adaptation and Mitigation
- Weather-Ready Nation

### **NOAA Strategic Goals**

- Serve society's needs for weather and water
- Understand climate variability and change to enhance society's ability to plan and respond
- Provide critical support for the NOAA mission

### **CIMSS Research Themes**

- Satellite Meteorology Research and Applications
- Satellite Sensors and Techniques

### **Proposed Work**

This project involves the implementation of the CIMSS GOES-R AWG Cloud Algorithms to the data from the Suomi NPP Visible Infrared Imaging Radiometer Suite (VIIRS). Specifically, this project covers the implementation of the ABI cloud mask (ACM), the ABI Cloud Height Algorithm (ACHA) and the Daytime Cloud Optical and Microphysical Properties (DCOMP) Algorithm. In all, this project covers the generation on VIIRS of the following cloud products: clear-sky mask, top height, temperature and pressure, optical depth, particle size, water/ice path and base height. The motivation for this project is the demonstration of efficient processing of VIIRS data with NOAA and the generation of a set of products from VIIRS that is physically consistent with those from GOES-R.

The function of GOES-R ABI Cloud Mask (ACM) is to provide a binary clear-sky mask (clear or cloudy). In addition to this official product, the ACM also provides a 4-level cloud mask (clear, probably clear, probably cloudy and cloudy). This 4-level mask is an intermediate product and is generated for those algorithms and users who are familiar with the 4-level masks currently generated by NASA and NOAA.

The ABI Cloud Height Algorithm (ACHA) is an infrared-only retrieval that uses an analytical forward model in an optimal estimation framework to estimate cloud temperature, emissivity and  $b$  (an IR microphysical parameter). Cloud height and pressure are derived from the temperature and knowledge of the atmospheric profiles from the NWP ancillary data. For JPSS, ACHA is also required to estimate the cloud-base height and the development of this technique is included in this project. VIIRS does not offer the same set of IR channels as offered by the GOES-R ABI. In the ABI version of ACHA, the 11, 12 and 13.3  $\mu\text{m}$  channels are used. On VIIRS, only the 8.5, 11 and 12  $\mu\text{m}$  channels are available (Heidinger et al., 2010). ACHA uses scattering models of each channel within its forward model. Using the same methods employed on the ABI, the VIIRS channels will be incorporated. The ACHA results on VIIRS are critical since they are used other products including the DCOMP and NCOMP cloud algorithms and the Atmospheric Motion Vectors (AMV) algorithms.

One other crucial component is the daytime cloud optical and microphysical properties (DCOMP) algorithm, which generates estimates of cloud optical thickness, cloud effective radius and



ice/water path during daylight conditions [Walther and Heidinger, 2012]. DCOMP was developed with support from the NOAA Geostationary Operational Environmental Satellite R Series (GOES-R) Algorithm Working Group (AWG) to be the official algorithm for the Advanced Baseline Imager (ABI). The algorithm is based on bi-spectral approach with pre-computed forward operator stored in look-up-tables. DCOMP is performed within an optimal estimation framework, which allows physically based uncertainty propagation. Atmospheric-correction and forward-model parameters, such as surface albedo and gaseous absorber amounts, are obtained from numerical weather prediction reanalysis data and other climate datasets. DCOMP is set up to run on sensors with similar channel settings (e.g., MODIS, SEVIRI, AVHRR, VIIRS and Suomi NPP) and has been successfully exercised on most current meteorological imagers.

### **Summary of Accomplishments and Findings**

All retrieval components in PATMOS-x were adjusted to process also VIIRS observations. For ACM we generated VIIRS-specific Bayesian mask coefficients by using NPP-CALIPSO collocated data. The coverage was extended to Polar Regions, because this was not needed for the geostationary sensors. ARM could be successfully implemented and tested in PATMOS-x environment.

For ACHA the optimal estimation tool within PATMOS-x had to be adjusted to a 3-channel retrieval. We developed the analytic forward model and the Kernel relationship for the 8.5, 11 and 12-micron channels.

DCOMP was adjusted to be capable to run for all channel modes for VIIRS. We generated the look-up-tables for water and ice phase. VIIRS DCOMP could be implemented in PATMOS-x and GEOCAT.

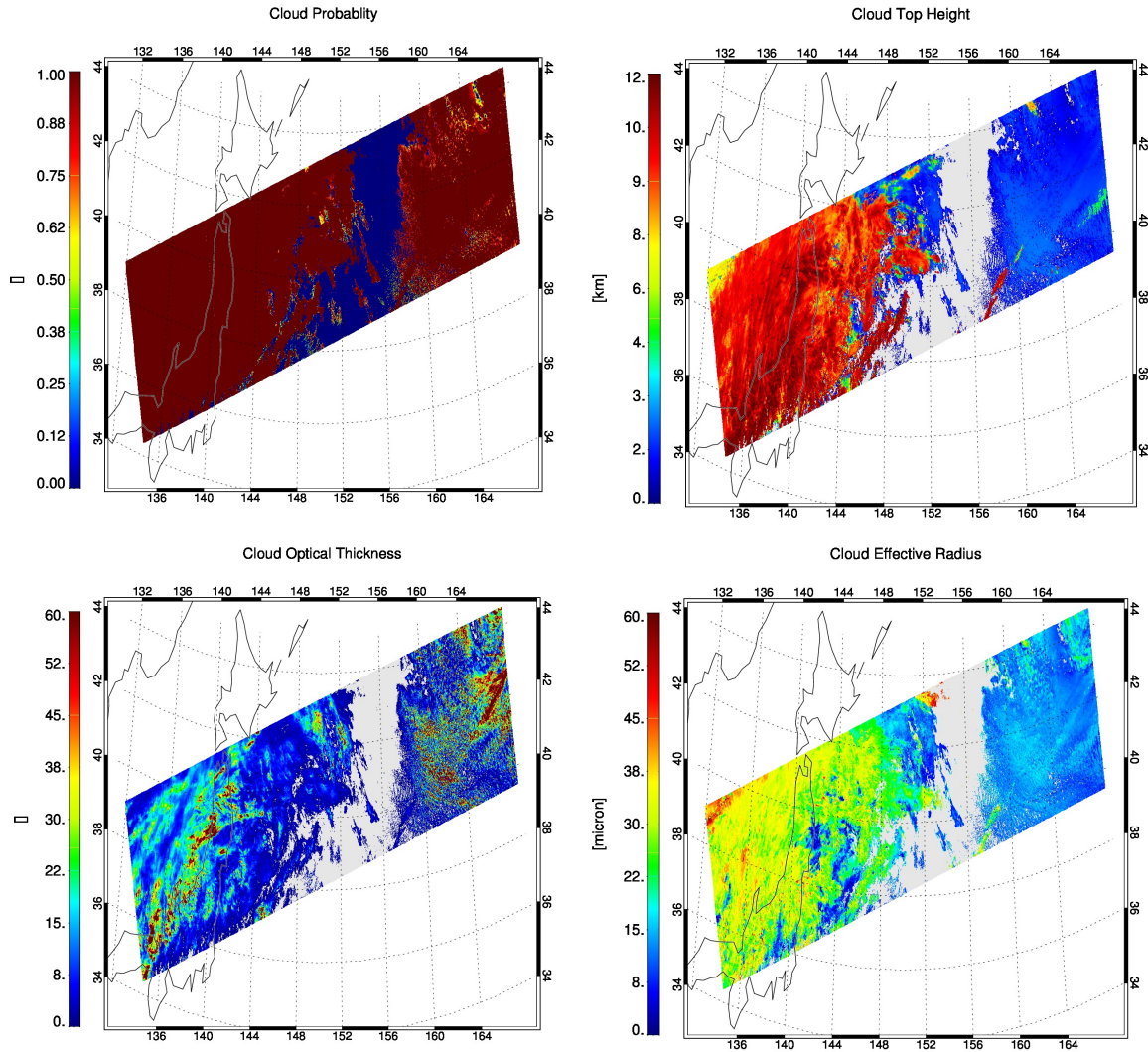
### **References**

Heidinger, AK, Pavolonis, MJ, Holz, RE, Baum, BA, Berthier, S (2010). Using CALIPSO to explore the sensitivity to cirrus height in the infrared observations from NPOESS/VIIRS and GOES-R/ABI. *JGR-A*, **115**, D00H20.

Walther, A., A. Heidinger, W. Straka, 2011: ABI algorithm theoretical basis document for DCOMP., version 2.0 NOAA/NESDIS, 61pp. [Available online at [http://www.goes-r.gov/products/ATBDs/baseline/Cloud\\_DCOMP\\_v2.0\\_no\\_color.pdf](http://www.goes-r.gov/products/ATBDs/baseline/Cloud_DCOMP_v2.0_no_color.pdf)]

Walther, A. and A. Heidinger (2012): Implementation of the Daytime Cloud Optical and Microphysical Properties Algorithm in PATMOS-x. *JAMC* 2012 doi:10.1175/JAMC-D-11-0108.1





**Figure 18.2.1.** VIIRS PATMOS-x cloud retrieval results for ACM (upper left), ACHA (upper right) and DCOMP for 11 March 2012 0251 UTC.

### 18.3. Delivery of VIIRS Cloud Phase and Volcanic Ash Algorithms to NESDIS Operations

**CIMSS Task Leader: Corey Calvert**

**CIMSS Support Scientist: Justin Sieglaff**

**NOAA Collaborator: Michael Pavolonis**

**NOAA Long Term Goals**

- Weather-Ready Nation

**NOAA Strategic Goals**

- Support the nation's commerce with information for safe, efficient and environmentally sound transportation

**CIMSS Research Themes**

- Satellite Meteorology Research and Applications



- Satellite Sensors and Techniques
- Environmental Models and Data Assimilation

### Proposed Work

The GOES-R AWG and RRR projects have resulted in development of new cloud phase and volcanic ash algorithms in recent years. These algorithms were designed with the GOES-R ABI spectral coverage (16 bands). We propose to modify the GOES-R Cloud Phase and Volcanic Ash algorithms to the VIIRS spectral channel availability and delivery these algorithms to NESDIS operations.

### Summary of Accomplishments and Findings

The GOES-R Volcanic Ash detection and physical retrieval (height, mass loading, and effective radius) have been modified to account for reduced spectral information compared to GOES-R ABI (e.g., lack of 13.3  $\mu\text{m}$  channel for physical retrievals). However, like GOES-R ABI, VIIRS contains an 8.5  $\mu\text{m}$  channel, which is critical for volcanic ash detection. The increased spatial resolution (VIIRS: 750 m IR resolution versus ABI: 2,000 m IR resolution) results in the ability to detect and retrieve physical properties of smaller volcanic ash clouds. Figure 18.3.1 shows an example of the modified GOES-R ash detection and retrievals using VIIRS. A spatially very small ash cloud from the Tungurahua volcano in Ecuador was detected, with a retrieved height between 8 and 9 km (26 and 30 kft). The early results are encouraging and continued research into modifying the GOES-R Volcanic ash algorithms for optimal use with VIIRS will continue.

Like the volcanic ash algorithm, the cloud type algorithm was also modified from the one created for the GOES-R ABI. The thresholds for the cloud type algorithm were theoretically developed for VIIRS pre-launch based on the modeling of single layer water and ice clouds (Pavlonis et al., 2005). Now that VIIRS is in orbit and data is flowing, initial evaluation indicates that some modifications are needed in order to improve the performance of the algorithm. These modifications include fine tuning threshold functions and values that are used to differentiate between the cloud phase and different cloud types. We have developed a tool that evaluates the VIIRS cloud type algorithm using collocated Cloud-Aerosol Lidar with Orthogonal Polarization (CALIOP) data. The high-resolution lidar data are very sensitive to the cloud phase and is therefore a good dataset to use for validating the cloud type algorithm. Further evaluation and threshold tuning is needed, but the first round of modifications has shown relatively significant improvement in the accuracy of differentiating between liquid water, mixed phase, opaque ice, cirrus and overlapping clouds.

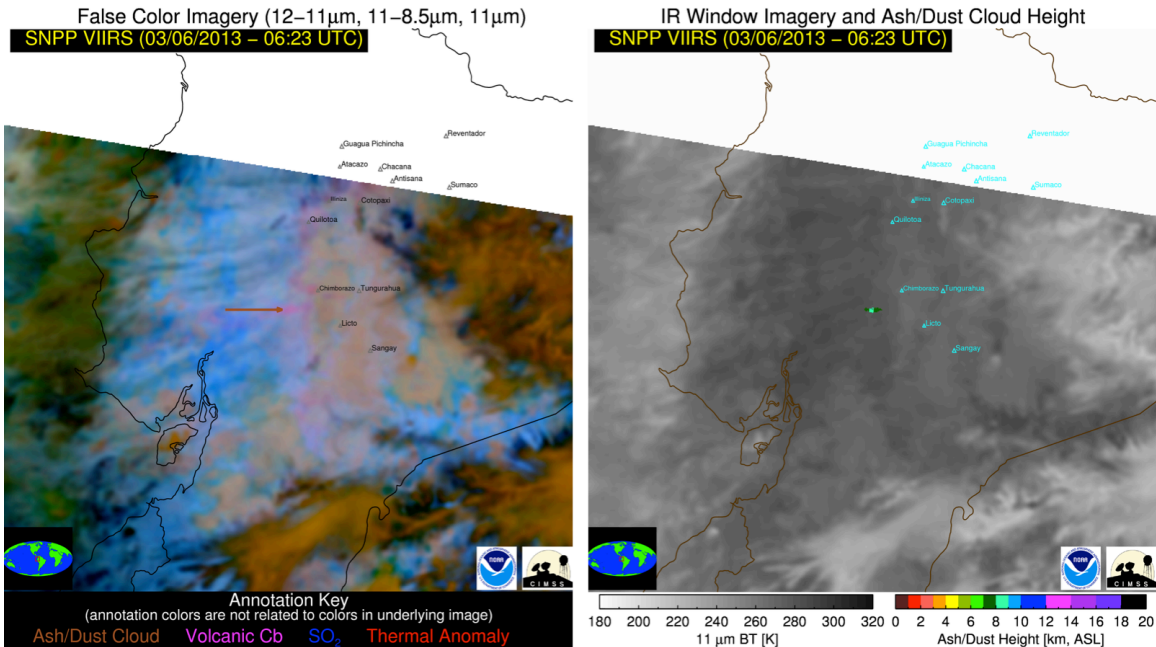
### References

- Pavlonis, Michael J., Andrew K. Heidinger, Taneil Uttal, 2005: Daytime Global Cloud Typing from AVHRR and VIIRS: Algorithm Description, Validation, and Comparisons. *J. Appl. Meteor.*, **44**, 804–826.
- Pavlonis, M. J., 2010: Advances in extracting cloud composition information from spaceborne infrared radiances: A robust alternative to brightness temperatures. Part I: Theory. *J. Applied Meteorology and Climatology*, **49**, 1992-2012.
- Pavlonis, M. J., A. K. Heidinger, and J. Sieglaff (2013), Automated retrievals of volcanic ash and dust cloud properties from upwelling infrared measurements, *J. Geophys. Res. Atmos.*, 118, doi:[10.1002/jgrd.50173](https://doi.org/10.1002/jgrd.50173).



**Tungurahua – March 06, 2013**

**Higher spatial resolution and additional spectral channels are critical. VIIRS IR channels have a spatial resolution of 750 m!**



**Figure 18.3.1.** An example of output from modified GOES-R Volcanic algorithms for use with VIIRS from an eruption of Tungurahua volcano at 0632 UTC 06 March 2013. The left panel is a false color VIIRS imagery, with a small ash cloud denoted by the brown arrow. The right panel is the 11 µm brightness temperature imagery with retrieved ash height in the dark/light green (approximately 8-9 km).

**18.4. JPSS Algorithm Integration Team**

**CIMSS Task Leader: R. K. Garcia**

**CIMSS Support Scientists: G. D. Martin, E. N. Schiffer, W. C. Straka III**

**NOAA Collaborator: W. Wolf**

**NOAA Strategic Goals**

- Provide critical support for the NOAA mission

**CIMSS Research Themes**

- Satellite Meteorology Research and Applications

**Proposed Work**

The JPSS AIT-MW supports the NOAA JPSS AIT toward the goal of implementing pseudo-operational product generation, validation, and visualization capabilities for SNPP and follow-on polar satellites.

Algorithms shall be principally derived from GOES-R algorithm implementations, with necessary updates and modifications for multi-satellite use. AIT-MW will principally be supporting algorithms originating at UW-Madison/CIMSS, primarily the cloud algorithms. This includes



technical, implementation, and portability/compatibility concerns for several target systems. It also includes management of testing, delivery, and acceptance process.

For GOES-R, AIT-MW has provided generalized technical expertise in making CIMSS algorithms ready for integration to the GOES-R pseudo-operational framework. The end result of that effort is the delivery of reference datasets and reference software implementations for use by the operational integration vendor, as well as algorithm theory and validation documentation.

For JPSS, efforts will be focused on risk-reduction for NPP / JPSS, i.e., validating for NPP a subset of product algorithms researched for and initially applied to GOES-R.

### **Activities for 2012**

The 2012 activities will be primarily focused on applying the GOES-R cloud phase and volcanic ash algorithms to VIIRS and making modifications where necessary. Some modifications will be needed. Unlike the Advanced Baseline Imager on GOES-R, VIIRS does not have channels centered near 7.3 and 13.3  $\mu\text{m}$ . Both of these channels are used in the GOES-R volcanic ash algorithm and the 7.3  $\mu\text{m}$  channel is used in the GOES-R cloud phase algorithm. While the GOES-R algorithms can be applied to VIIRS without these channels (with some modifications), the product accuracy (in particular the accuracy of the ash cloud heights and the multilayered cloud detection in the cloud phase algorithm) will be impacted. If time allows, we may explore combining CrIS and VIIRS measurements to prevent a loss in product accuracy. The GOES-R like JPSS cloud phase and volcanic ash products will also be validated using the methods developed in preparation for GOES-R.

### **Milestones for 2012**

- Reviews complete for candidate algorithms and current implementations, identifying strategy for use with VIIRS input.
- Framework software interfaces reviewed and compared/contrasted between AIT Framework, GEOCAT, CLAVR-X, NPP IDPS/ADL, Harris/AER DMI for GOES-R. Preliminary software portability strategy defined.
- Algorithms divided into trailblazer, second round, final round by expected difficulty level.
- Demonstration of trailblazer algorithm on development framework (likely Cloud products on GEOCAT) using VIIRS.

### **Summary of Accomplishments and Findings**

Development of the applying the GOES-R algorithms to VIIRS will not start until after the Critical Design Review of the various algorithms. However, for other projects, such as the VIIRS Polar Winds project, there have been a couple of algorithms that have been ported from CLAVR-x into the AIT Framework, with minimal effort. These include the CLAVR-x Cloud Type, which acts as a proxy for the Cloud Type algorithm, and ABI Cloud Height algorithms have been ported into the Framework. In addition, GEOCAT has been refactored to be able to read in the VIIRS Moderate Resolution Band (“M-Band”) SDR and geolocation data, as well as be able to calculate the clear sky radiance values using both the PFAAST and CRTM models. It is expected that beginning in May 2013 that, as algorithm development picks up, algorithm refactoring will begin in earnest.

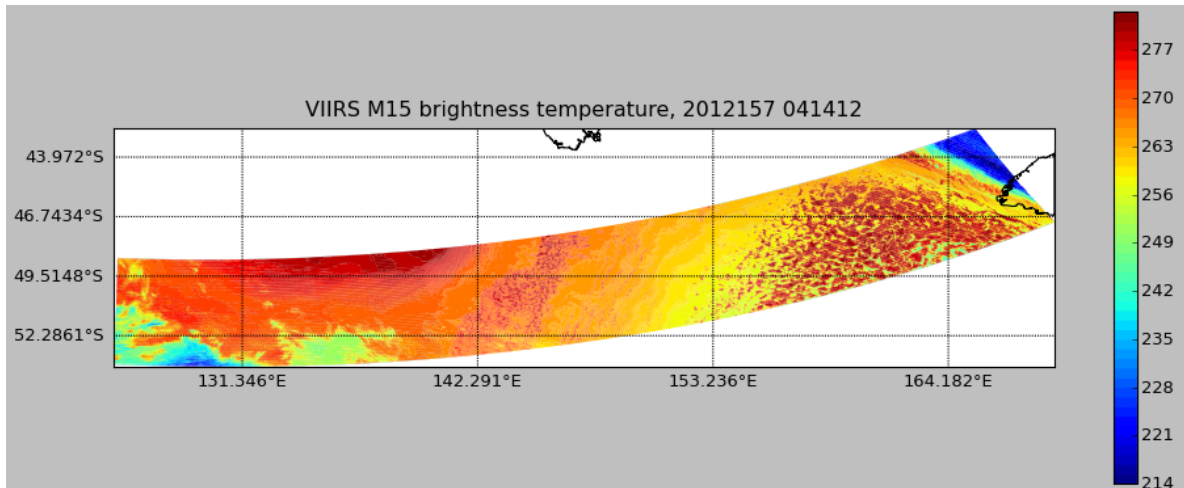


Figure 18.4.1. VIIRS Level 1 output from Geocat.

## 19. Atmospheric Soundings from Suomi NPP/Aqua and Metop-A/Metop-B Sounding Pairs

**CIMSS Task Leaders: Elisabeth Weisz, William L. Smith Sr.**

**CIMSS Support Scientist: Nadia Smith**

**NOAA Collaborator: R. Bradley Pierce**

### NOAA Long Term Goals

- Climate Adaptation and Mitigation
- Weather-Ready Nation

### NOAA Strategic Goals

- Serve society's needs for weather and water

### CIMSS Research Themes

- Satellite Meteorology Research and Applications
- Satellite Sensors and Techniques

### Proposed Work

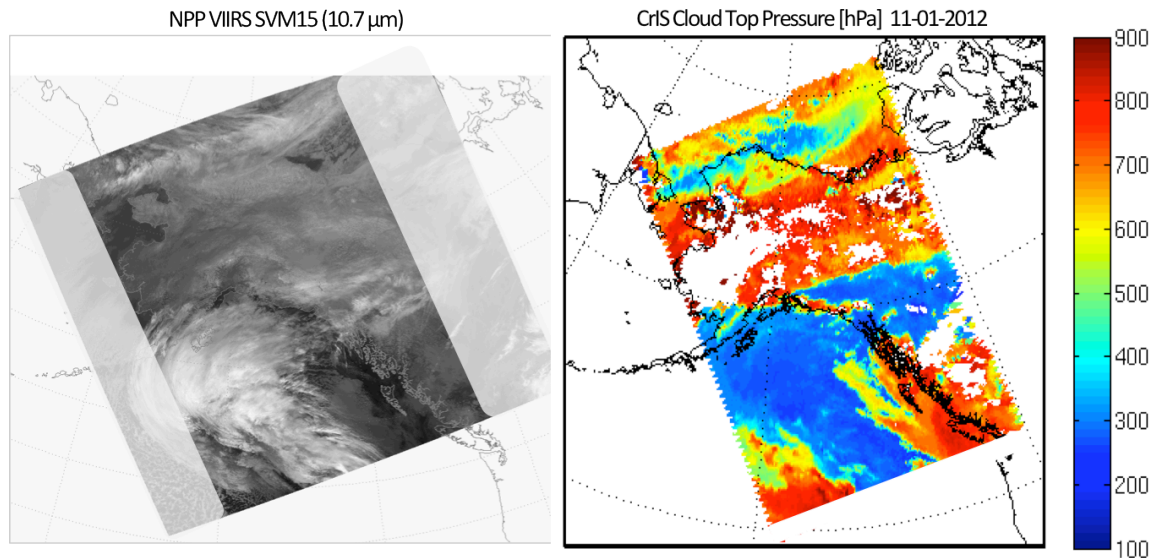
CIMSS proposes to prepare atmospheric soundings and their time derivatives as well as cloud and water vapor tracer wind data from high-spectral resolution infrared sounder (AIRS, IASI and CRIS) measurements for the regional use in weather prediction. This involves the demonstration of the extraction of atmospheric soundings and their time tendencies from Aqua/NPP and Metop-A/Metop-B radiance spectra using the Dual-Regression (DR) retrieval method. Furthermore, we propose to prepare atmospheric profile and cloud time tendency products for near real-time viewing through the Advanced Weather Interactive Processing System (AWIPS). This will add new meteorological data to forecasting activities by NWS users. This work requires close collaboration with Alaska Weather Forecast Offices (WFOs) through the University of Alaska Fairbanks (UAF) to demonstrate the utility of the products.

### Summary of Accomplishments and Findings

The University of Wisconsin hyperspectral retrieval software package for direct-broadcast applications has been released in November 2012 as part of the Community Satellite Processing Package (CSPP). This multi-instrument retrieval algorithm is based on the Dual-Regression (DR) method for use with CrIS (Cross-track Infrared Sounder), AIRS (Atmospheric Infrared Sounder)



or IASI (Infrared Atmospheric Sounding Interferometer) radiance measurements. It retrieves a suite of surface, cloud and atmospheric parameters at single field-of-view resolution. We met with UAF scientists and Alaska WFOs forecasters in Fairbanks (27-28 Feb 2013) to demonstrate the potential of incorporating hyperspectral sounding data and cloud parameters into assimilation and forecast systems. The feedback we received is used to specifically address the needs of NWS forecasters. It has been shown that hyperspectral retrieval data (e.g., cloud top pressure, cloud optical thickness) adds valuable quantitative information to visible imagery. For example, from the VIIRS image shown in Figure 19.1 (left) optically thin and optically thick clouds can be observed, whereas the CrIS cloud height retrievals (right) complement our understanding of the atmospheric situation by adding absolute values of the cloud altitudes.



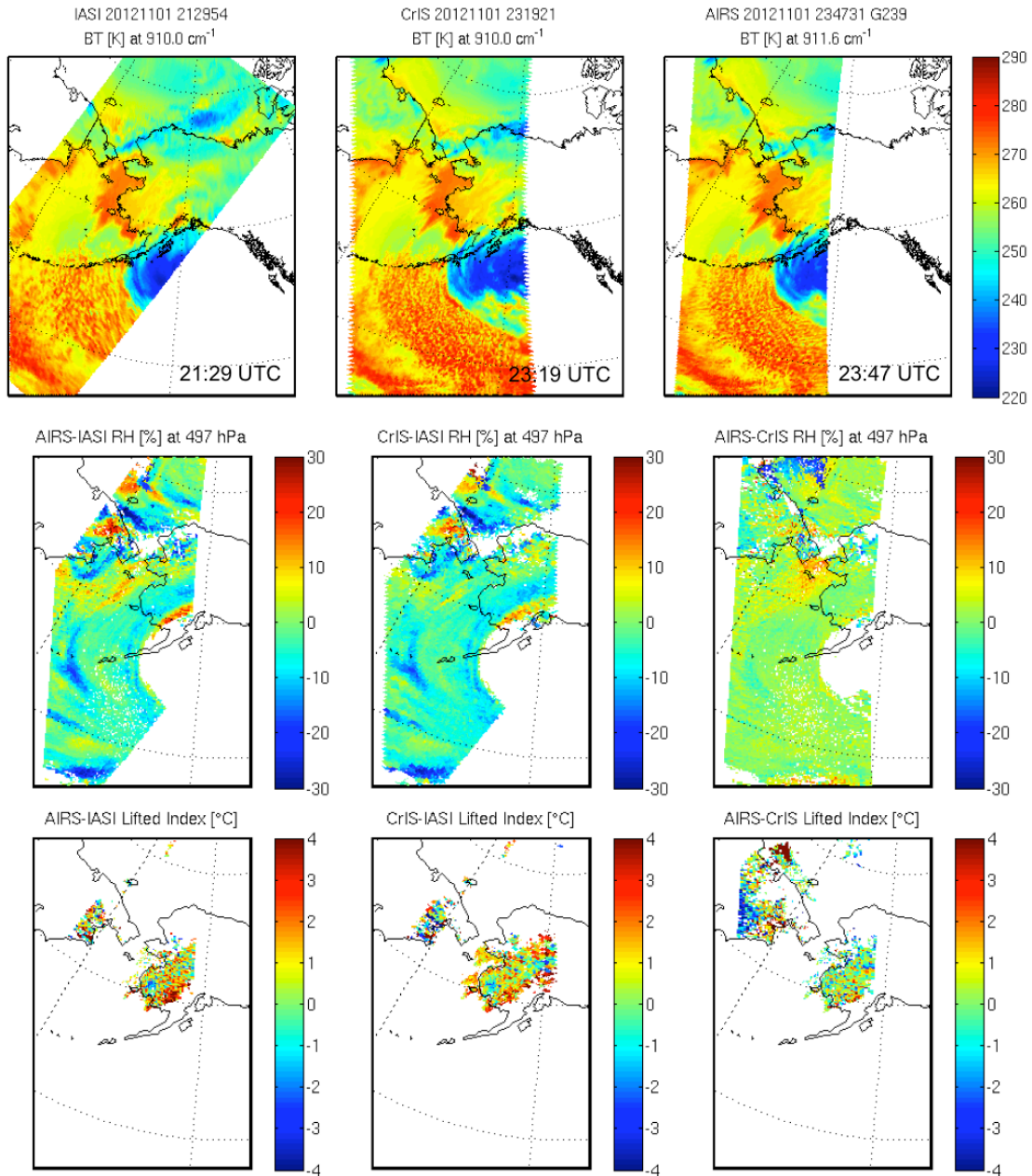
**Figure 19.1.** VIIRS 10.7 $\mu$ m band and CrIS cloud top pressure retrievals (01 Nov 2011).

For high latitudes, such as for the Alaskan region, Aqua/NPP and Metop overpasses are frequent enough to allow the study of atmospheric changes. Hence, the availability of atmospheric soundings from multiple instruments in consecutive orbits enables observation of atmospheric moisture fluxes, as well as cloud and stability tendencies obtained from the sounding data. One example, involving L1 and L2 data from all three polar-orbiting sounders, is shown in Figure 19.2.

To support WFOs a number of L2 products were selected, i.e., cloud top pressure, cloud optical thickness, temperature and relative humidity at selected levels, stability indices, as well as atmospheric parameter differences between consecutive orbits. These are currently converted to AWIPS. This provides an easy tool for forecasters to view imager and sounder products simultaneously and therefore fully utilize the sounders' information about the atmosphere.

### **Publications and Conference Reports**

Smith, W. L., E. Weisz, S. Kirev, A. Larar, and H. Revercomb, 2012: Weather and Climate Applications of Ultraspectral IR Radiance Measurements. Presentation at the International Radiation Symposium (IRS), 6-10 August 2012, Berlin, Germany.



**Figure 19.2.** Top: IASI, CrIS and AIRS brightness temperatures at 910 wavenumbers from 01 Nov 2012. Differences in retrieved relative humidity (RH) at 500 hPa (middle panels) and Lifted Index (bottom panels) between AIRS and IASI, CrIS and IASI, and AIRS and CRIS.

Smith, W. L., E. Weisz, S. Kirev, D. K. Zhou, Z. Li, and E. E. Borbas, 2012: Dual-Regression Retrieval Algorithm for Real-Time Processing of Satellite Ultraspectral Radiances. *J. Appl. Meteor. Clim.*, **51**, Issue 8, 1455-1476.

Weisz, E., W. P. Menzel, N. Smith, R. Frey, E. E. Borbas, and B. A. Baum, 2012: An approach for improving cirrus cloud top pressure/height estimation by merging high spatial resolution



infrared window data with high spectral resolution sounder data. *J. Appl. Meteor. Climatol.*, **51**, 1477-1488.

Smith, W. L., E. Weisz, H. Revercomb, and A. Larar, 2012: Atmospheric Dynamics From Suomi NPP/Aqua and Metop-A/Metop-B Sounding Pairs. Presentation at the EUMETSAT Meteorological Satellite Conference, 3-7 September 2012, Sopot, Poland.

Smith, W. L., E. Weisz, and H. Revercomb, 2012: Differences between AIRS, IASI and CrIS Sounding Retrievals – Implications for Climate Monitoring. Presentation at the CLARREO Science Definition Team (SDT) Meeting, 16-18 October 2012, Boulder, CO, USA.

Smith, W. L., E. Weisz, D. Tobin, X. Liu, R. Knuteson, H. Revercomb, A. Larar, and M. Goldberg, 2012: Comparison of AIRS and CrIS Radiance & Retrievals. Presentation at the NASA Sounder Science Team Meeting, 13-16 November 2012, Greenbelt, MD, USA.

Weisz, E., W. L. Smith, N. Smith, Kathy Strabala, et al., 2012: Atmospheric Profile and Cloud Parameter Retrievals from Hyperspectral Infrared Radiances. Presentation at the CIMSS Science Symposium, 12 December 2012, Madison, WI, USA.

Weisz, E., W. L. Smith, and Nadia Smith, 2013: Advances in simultaneous atmospheric profile and cloud parameter regression based retrieval from high-spectral resolution radiance measurements. Submitted to *Journal of Geophysical Research*.

## **20. CIMSS Participation in the JPSS Risk Reduction Program for 2012**

### **20.1. Near Real-time Assimilation System Development for Improving Tropical Cyclone Forecasts with NPP/JPSS Sounding Measurements**

**CIMSS Task Leader: Jun Li**

**CIMSS Support Scientists: Jinlong Li, Pei Wang**

**NOAA Collaborators: Tim Schmit, John L. Beven, Mark DeMaria**

**NOAA Long Term Goals**

- Weather-Ready Nation

**NOAA Strategic Goals**

- Serve society's needs for weather and water
- Provide critical support for the NOAA mission

**CIMSS Research Themes**

- Satellite Meteorology Research and Applications
- Environmental Models and Data Assimilation

#### **Proposed Work**

We propose to use the NPP/JPSS sounding measurements for improving the prediction of tropical cyclone (TC) genesis and evolution. The work will use the regional numerical weather prediction (NWP) models (WRF - Weather Research and Forecasting, and HWRF – Hurricane WRF) and the advanced data assimilation methodologies (GSI, 3DVAR and 4DVAR). CIMSS scientists will develop a near real time assimilation system (SDAT – Satellite sounder data assimilation for TC forecasts) based on the combination of GSI and WRF and use NPP/JPSS sounding measurements from Community Satellite Processing Package (CSPP) or NOAA data ports (IDPS and NDE), to





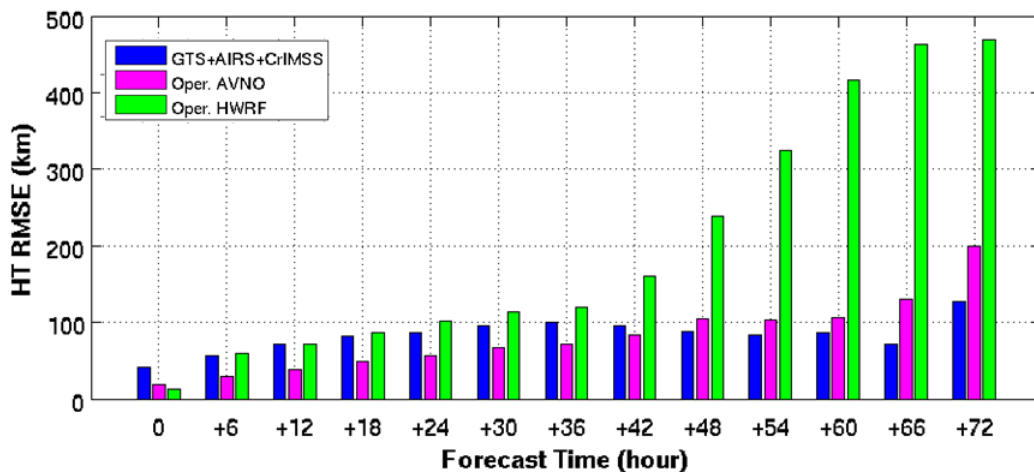
serve as an application demonstration system on the utilization of JPSS sounding measurements for TC forecasting.

### Summary of Accomplishments and Findings

In order to study the use of satellite sounder data in a more realistic operational environment, CIMSS scientists have implemented the NCEP operational community Gridpoint Statistical Interpolation (GSI) for regional WRF (Weather Research and Forecasting – WRF-ARW 3.2.1) model. The GSI system was initially developed by NOAA/NCEP/EMC as a next generation global/regional analysis system, and now it is the operational grid-space regional analysis system at NOAA/NCEP. With GSI implemented into WRF, we have the flexibility on assimilating various satellite data in a realistic operational environment, thus it makes the research results more convincing for transition to the operation. Based on WRF/GSI, CIMSS scientists are also developing the satellite Sounder Data Assimilation for TC forecasts – SDAT, SDAT comprises of data ingesting and processing, data assimilation, forecasting and forecast analysis.

We have conducted the NPP sounder assimilation for hurricane Sandy (2012) forecast experiments, three types of data are used in the experiments: (a) GTS - data obtained through WMO's global telecommunication system, GTS contains all the conventional data and other related data, (b) AIRS – AIRS single field-of-view (SFOV) soundings developed at CIMSS and obtained from IMAPP (International MODIS and AIRS Processing Package), and (c) CrIMSS - CrIMSS sounding EDR from JPSS Cal/Val team.

The forecast experiments are conducted in WRF/GSI with 12 km spatial resolution, in order to investigate the impact of using satellite sounder data for Sandy forecasts, GTS+AIRS+CrIMSS data are used in the experiments. Data are assimilated every 6 hours followed by 72 hour forecasts. The assimilation window is +/- 1 hour. The experimental forecasts are compared with the operational regional HWRf and global GFS. Figure 20.1.1 shows the Sandy track root mean square error (RMSE) from CIMSS experimental forecasts with GTS, AIRS and CrIMSS data assimilated, the operational regional HWRf forecasts and the operational global GFS forecasts (AVNO). Forecasts start from 12 UTC 25 Oct and valid 18 UTC 30 Oct 2012.

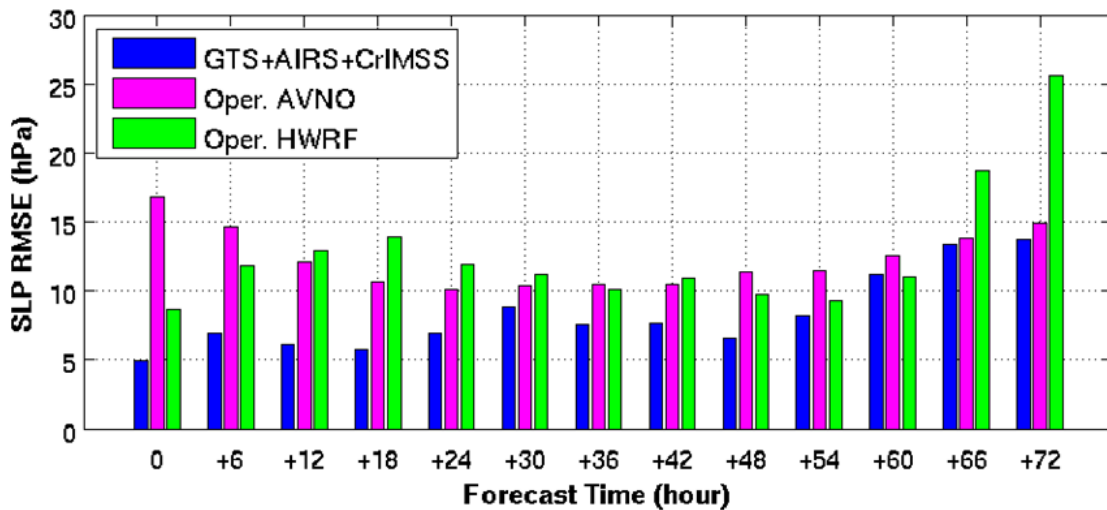


**Figure 20.1.1.** Sandy track forecast RMSE (km) from CIMSS experimental forecasts with GTS, AIRS and CrIMSS data assimilated, the operational regional HWRf, and the operational global GFS forecasts (AVNO). Forecasts start from 12 UTC 25 Oct and valid 18 UTC 30 Oct 2012.



Both CIMSS experimental and operational GFS track forecasts are good during that time period, GFS (AVNO) is good at the beginning time, but from at 18UTC 26 October, the track error becomes large.

Figure 20.1.2 is the same as Figure 20.1.1 but for central sea level pressure (SLP) RMSE (hPa). In general, when satellite sounder data are assimilated, the SLP forecasts have been improved compared with the two operational models (GFS and HWRF). It should be noted that the SLP of AVNO is always weak when compared with best track from National Hurricane Center (NHC), and it is difficult to become strong according to SLP, but HWRF and CIMSS results are good at intensity forecasts during that time period. That means regional NWP has the advantage on intensity forecasts.



**Figure 20.1.2.** Sandy SLP RMSE (hPa) from CIMSS experimental forecasts with GTS, AIRS and CrIMSS data assimilated the operational regional HWRF, and the operational global GFS forecasts (AVNO). Forecasts start from 12 UTC 25 Oct and valid 18 UTC 30 Oct 2012.

As a forecast comparison example, Figure 20.1.3 shows the 72 hour track forecasts start from 18 UTC on 27 October 2012 from CIMSS experimental, operational HWRF and operational GFS.

### Publications and Conference Reports

Li, J., P. Wang, T. Schmit, C. Velden, and Jinlong Li, 2013: Improving tropical cyclone forecasts with advanced sounding measurements from satellites, IOAS/TROPICALSYMP, AMS 93rd Annual Meeting, 06 – 10 Jan 2013, Austin, TX.

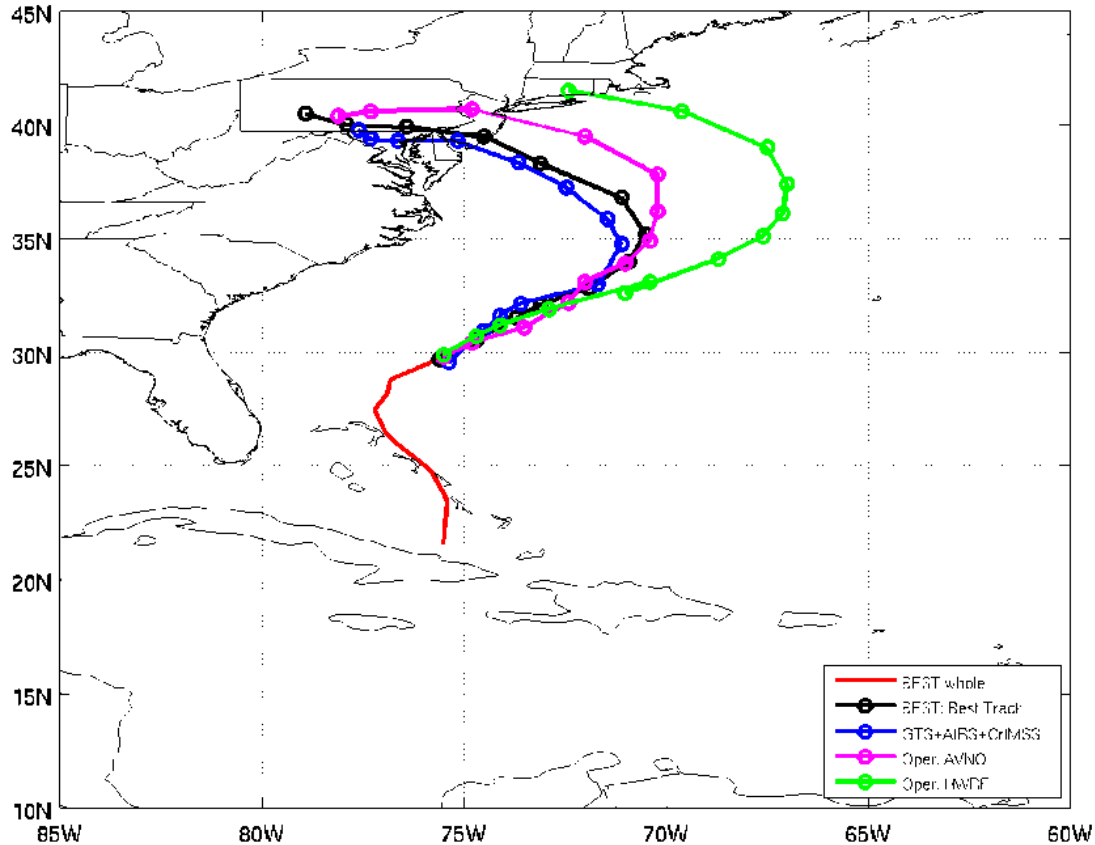
Li, J., T. Schmit, P. Wang, C. Velden, Jinlong Li, Z. Li, and W. Bai, 2013: Improving tropical cyclone forecasts in regional NWP with GOES-R water vapor and JPSS sounder measurements, JCSDA Session at the 93rd AMS Annual Meeting 06 – 10 Jan 2013, Austin, TX

Wang, P., J. Li, T. Schmit, J. Li, Z. Li, and W. Bai, 2013: Improve tropical cyclone forecasts with hyperspectral infrared sounder data, AMS 93rd Annual Meeting, 06 – 10 Jan 2013, Austin, TX.

Zheng, J., J. Li, Jinlong Li, and T. J. Schmit, 2012: Assimilating AIRS Soundings with WRF/3DVAR for Hurricane Forecast Improvement. *Journal of Applied Meteorology and Climate* (submitted).



Li, J., 2012: Assimilation of satellite data in regional NWP - progress and challenges, invited talk at the NSF sponsored Earth Cube Workshop – Shaping the Development of EarthCube to Enable Advances in Data Assimilation and Ensemble Prediction, 17 – 18 December 2012, Boulder, Colorado.



**Figure 20.1.3.** 72 hour forecasts starts from 18 UTC 27 October 2012 from CIMSS experimental (blue), Operational HWRF (green) and operational GFS (pink) along with the observation (black).

## 20.2. Application of JPSS Imagers and Sounders to Tropical Cyclone Track and Intensity Forecasting

**CIMSS Task Leader: Chris Velden**

**CIMSS Support Scientist: Derrick Herndon**

**NOAA Collaborator: Mark DeMaria**

**NOAA Long Term Goals**

- Weather-Ready Nation

**NOAA Strategic Goals**

- Serve society's needs for weather and water
- Provide critical support for the NOAA mission

**CIMSS Research Themes**

- Satellite Meteorology Research and Applications
- Satellite Sensors and Techniques



## Proposed Work

The time scale of tropical cyclone (TC) track and intensity changes is on the order of 12 hours, which makes JPSS instruments well suited for the analysis of these parameters. An application of JPSS data will be developed that uses thermal channels and radiance data from ATMS in the near storm environment to estimate TC intensity. This new information will be incorporated into existing intensity estimation techniques previously developed at CIMSS that already employ similar radiance data from AMSU and SSMIS. Once the ATMS algorithm is mature, the products will be made available through the JPSS Proving Ground to operational forecasters at the National Hurricane Center (NHC) and Joint Typhoon Warning Center (JTWC) for evaluation and feedback. If the evaluation is positive, the products can be transitioned to NHC and JTWC operations.

## Summary of Accomplishments and Findings

Work so far has focused on data collection and algorithm development using AMSU data in preparation for the ATMS data, obtaining preliminary ATMS passes from the 2012 season, evaluating differences between AMSU and ATMS temperature anomalies, development of the first version of the intensity estimation algorithm using the ATMS microwave radiances, and beginning to adjust the CIMSS intensity estimation algorithm based on initial findings.

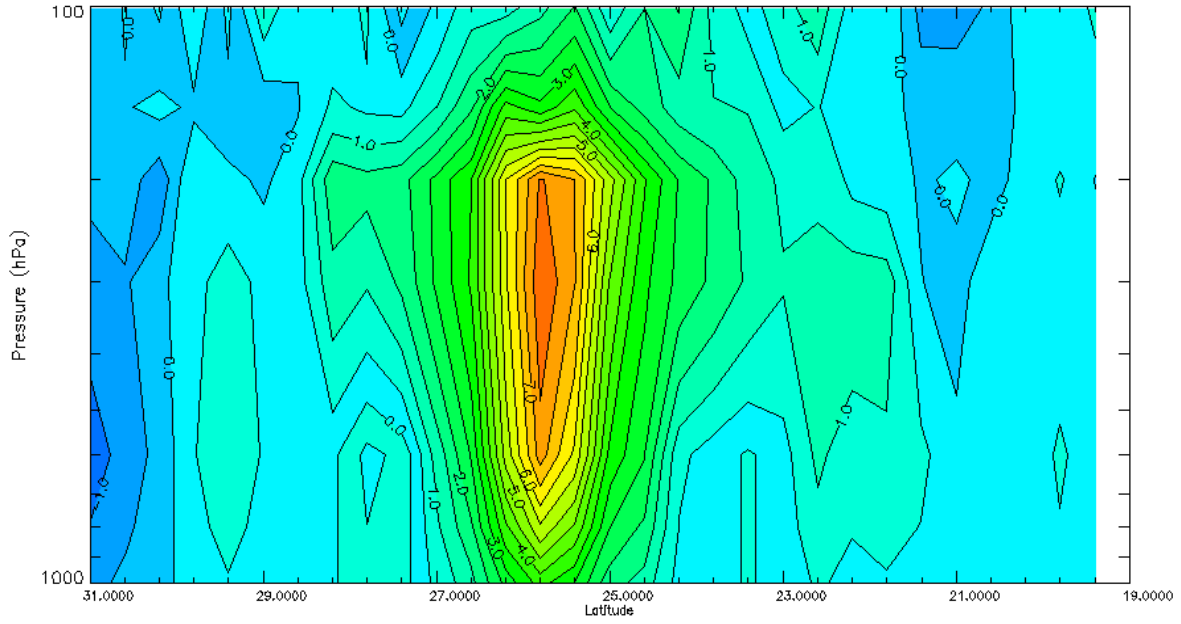
Brightness temperature (T<sub>b</sub>) anomaly cross sections and the resulting T<sub>b</sub> anomaly estimates for ATMS channels 7-9 can now be produced. Figure 20.2.1 shows example cross sections for Super Typhoon Jelewat (18W). The top image on September 25th represents a near ideal scan geometry with the center of the TC near nadir. Ideally, data matches would be limited to cases where aircraft ground truth data is available. However a lack of strong storms (CAT 4 and 5) in the Atlantic in 2012 required looking outside of this basin for cases that represent the upper bounds of the intensity scale. The T<sub>b</sub> anomaly with STY Jelewat for the 17 UTC overpass on the 25<sup>th</sup> yielded an anomaly of 7.9 K. This represents one of the largest T<sub>b</sub> anomalies observed by a microwave sounder in a TC (SSMIS has observed similar magnitudes for storms with large eyes). The CIMSS AMSU algorithm only yielded an anomaly of 5.5 K three hours later. Jelewat was estimated to have an observed surface pressure anomaly of 88 hPa while the CIMSS intensity algorithm based on predicted values estimates a pressure anomaly of 99 hPa.

Other observed ATMS T<sub>b</sub> anomalies can be seen compared with the predicted envelope of values in Figure 20.2.2 for ATMS channels 8 and 9. In general, the observed values fall along the left side of the envelope for channel 8. Many of these cases thus far are for passes that are significantly away from nadir. Additional processing of other storms from 2011-2012 will continue with work focused on comparing the observed ATMS values to the predicted values. Fine tuning of the algorithm based on the observations will be performed and the algorithm automated for 2013 data processing.



201218W\_Jelawat MMDD: 0925 YEAR: 2012 Time(UTC): 1705 ATMS  
ATMS Brightness Temperature Anomaly (Storm Center–Environment)

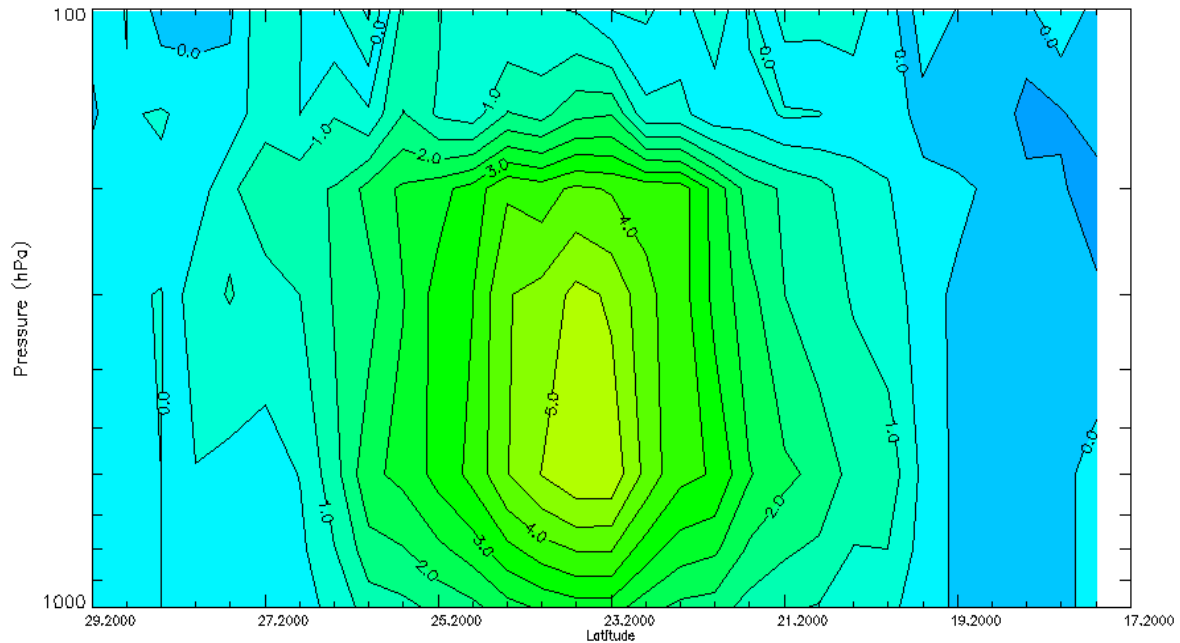
Vertical red line indicates aprox location of TC/Invest



Contour Interval = 0.5K

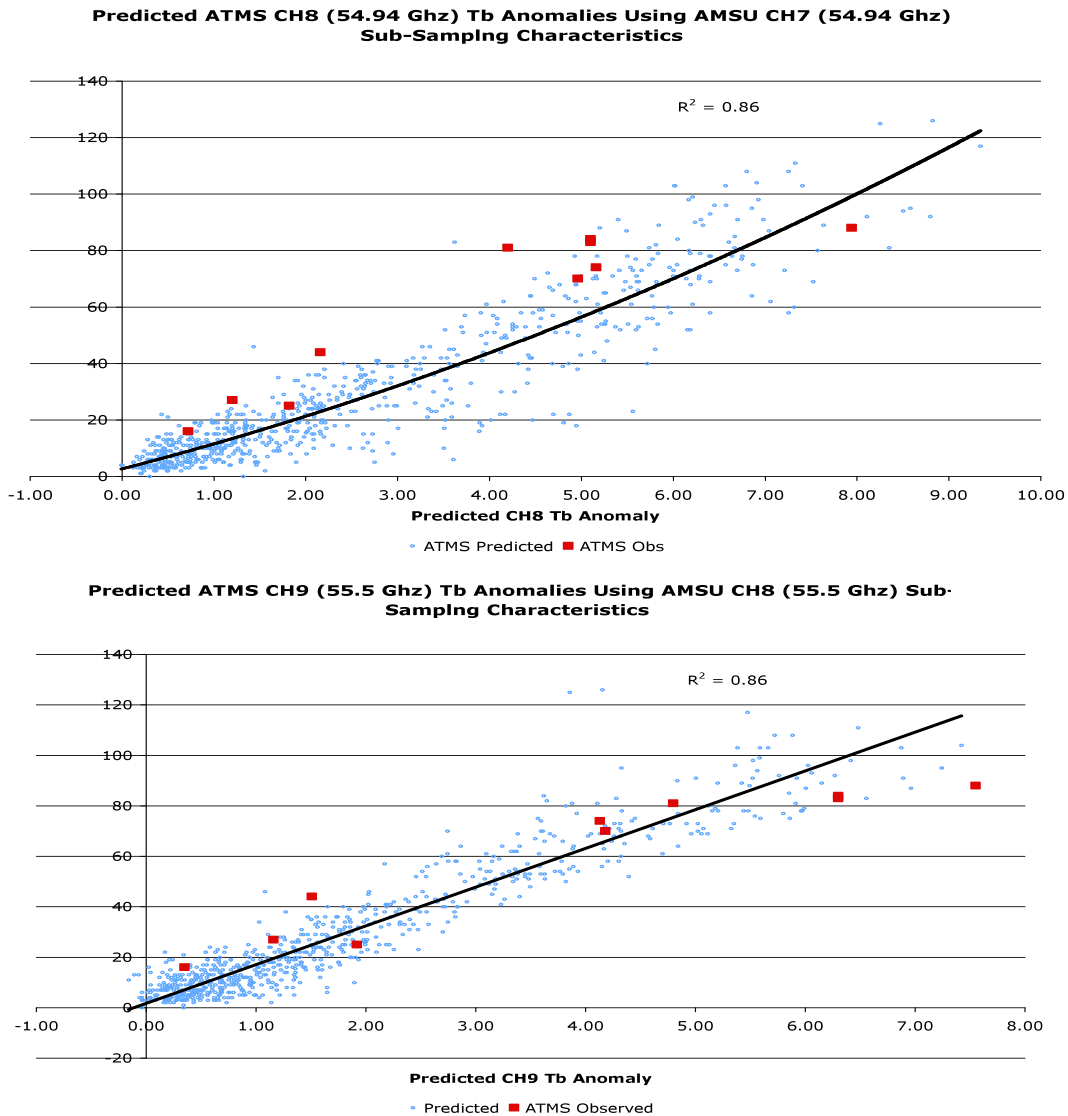
201218W\_Jelawat MMDD: 0928 YEAR: 2012 Time(UTC): 0520 ATMS  
ATMS Brightness Temperature Anomaly (Storm Center–Environment)

Vertical red line indicates aprox location of TC/Invest



Contour Interval = 0.5K

**Figure 20.2.1.** ATMS brightness temperature anomaly cross section for Super Typhoon Jelawat on September 25, 2012 (top) and September 28, 2012 (bottom). The maximum Tb anomaly in channel 8 (not shown) is 7.9 K on the 25<sup>th</sup>, and represents one of the strongest Tb anomalies observed by a microwave sounder. By the 28<sup>th</sup>, the Tb anomaly is reduced in magnitude while also expanding horizontally as the system underwent an ERC. Anomalous cooling due to precipitation attenuation in the lower channels has been removed for clarity.



**Figure 20.2.2.** Predicted ATMS channel 8 and 9 Tb anomalies using AMSU scan geometries (blue dots) compared to observed ATMS Tb anomalies for a sample of cases (red squares) in the Atlantic and Western Pacific. Represented storms and their respective observed surface MSLP anomalies (left axes) are: Super Typhoons Jelewat, Bopha and Typhoon Tembin for the Western Pacific, and Tropical Storms Ernesto, Gordon and Isaac for the Atlantic.

### 20.3. Advancing Nighttime VIIRS Cloud Products with the Day/Night Band

**CIMSS Task Leader: Andi Walther**  
**CIMSS Support Scientist: Denis Botambekov**  
**NOAA Collaborator: Andrew Heidinger**  
**NOAA Long Term Goals**

- Climate Adaptation and Mitigation
- Weather-Ready Nation



## **NOAA Strategic Goals**

- Serve society's needs for weather and water
- Understand climate variability and change to enhance society's ability to plan and respond
- Provide critical support for the NOAA mission

## **CIMSS Research Themes**

- Satellite Meteorology Research and Applications
- Satellite Sensors and Techniques

## **Proposed Work**

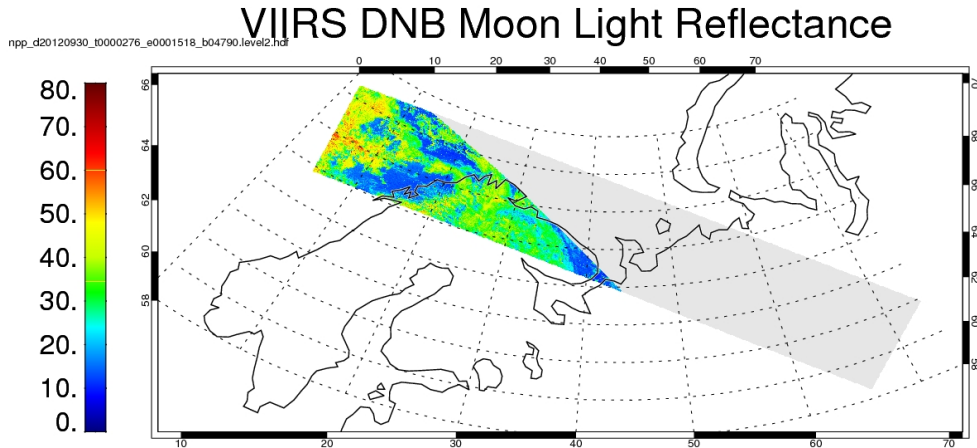
This project aims to use moonlight visible reflectance measured by the VIIRS Day/Night band channel to improve cloud property and cloud mask retrievals during nighttime. The new algorithms will be developed as a part of an existing cloud retrieval system (CLAVR-x).

This project involves the implementation of the CIMSS GOES-R AWG Cloud Algorithms to the data from the Suomi NPP Visible Infrared Imaging Radiometer Suite (VIIRS). Specifically, this project covers the implementation of the ABI cloud mask (ACM), the ABI Cloud Height Algorithm (ACHA) and the Daytime Cloud Optical and Microphysical Properties (DCOMP) Algorithm. Implementation support is also provided for the Nighttime Cloud Optical and Microphysical Properties (NCOMP) Algorithm. In all, this project covers the generation on VIIRS of the following cloud products: clear-sky mask, top height, temperature and pressure, optical depth, particle size, water/ice path and base height. The motivation for this project is the demonstration of efficient processing of VIIRS data with NOAA and the generation of a set of products from VIIRS that is physically consistent with those from GOES-R.

One of the crucial components is the daytime cloud optical and microphysical properties (DCOMP) algorithm, which generates estimates of cloud optical thickness, cloud effective radius and ice/water path during daylight conditions [Walther and Heidinger, 2012]. DCOMP was developed with support from the NOAA Geostationary Operational Environmental Satellite R Series (GOES-R) Algorithm Working Group (AWG) to be the official algorithm for the Advanced Baseline Imager (ABI). Descriptive technical details for the DCOMP algorithm for GOES-ABI are provided in the corresponding algorithm technical basis document (ATBD; Walther et al., 2011). The algorithm is based on bi-spectral approach with pre-computed forward operator stored in look-up-tables. DCOMP is performed within an optimal estimation framework, which allows physically based uncertainty propagation. Atmospheric-correction and forward-model parameters, such as surface albedo and gaseous absorber amounts, are obtained from numerical weather prediction reanalysis data and other climate datasets. DCOMP is set up to run on sensors with similar channel settings (e.g., MODIS, SEVIRI, AVHRR, VIIRS and Suomi NPP) and has been successfully exercised on most current meteorological imagers.

## **Summary of Accomplishments and Findings**

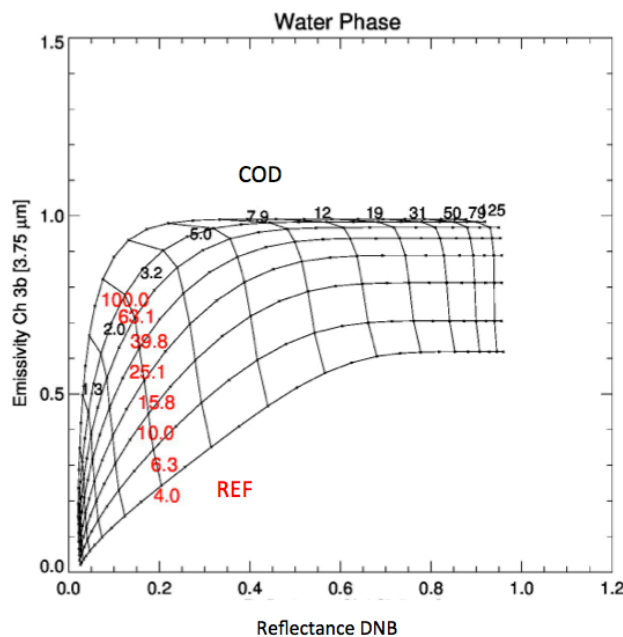
The effort in the reported period focused on one hand on the development and incorporation in CLAVR-x of the lunar reflection model in cooperation with Steven Miller from CIRA. We wrote FORTRAN and IDL software, which couples VIIRS radiance to a lunar irradiance model. The lunar reflectance is now a part of the CLAVR-x level-2 data output. Figure 20.3.1 shows an example for the lunar reflectance over North Atlantic and Scandinavia.



**Figure 20.3.1.** Image shows lunar reflectance from 30 September 2012.

The other focus was on the development of the new cloud optical properties retrieval for nighttime observations by use of the lunar reflection. We initially named the new retrieval as the “Nighttime Lunar Cloud Optical and Microphysical Properties” (NLCOMP) retrieval, following the name for the daytime retrieval DCOMP. The new retrieval modules are developed as stand-alone FORTRAN tools and work also within the CLAVR-x software environment.

We theoretically analyzed the information content of NLCOMP by computing the forward model. Figure 20.3.2 shows the dependency of reflectance in DNB channel and the emissivity in the near-infrared channel on microphysical parameters COD and REF for water phase. It could be shown that the observations can be expected as sensitive enough to retrieve optical thickness and effective radius for a wide range of clouds.



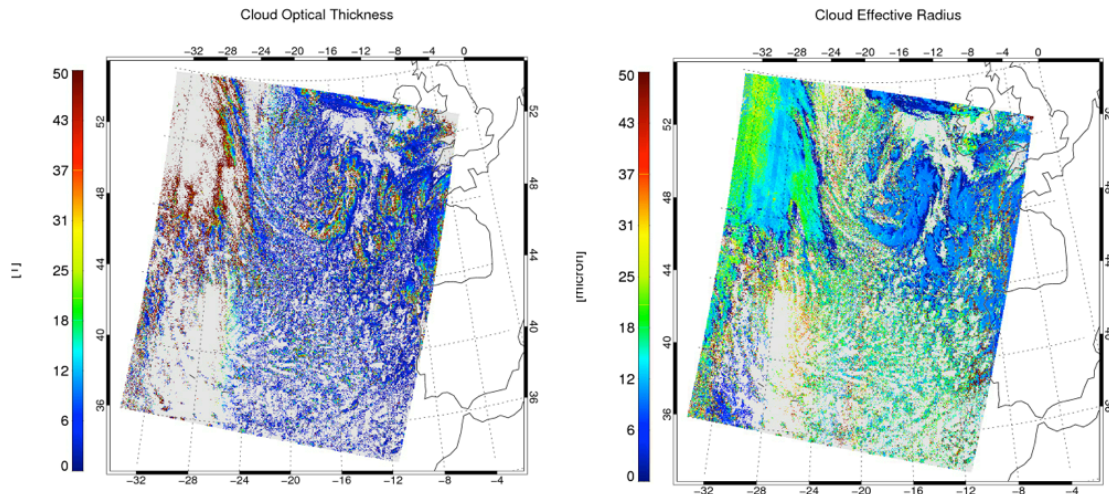
**Figure 20.3.2.** Theoretical computed reflection in DNB channel and emissivity in channel M-12 as a function of optical thickness and effective radius.





We have completed the generation of the necessary retrieval look-up-tables.

An initial version of NLCOMP was developed as a stand-alone FORTRAN retrieval tool, and is also implemented into an experimental version of CLAVR-x. We were able to process several weeks of NLCOMP results. One example of the output can be seen in Fig.20.3.3. We also worked on further daytime/nighttime DNB reflection comparisons, as evaluation of the lunar irradiance model is concurrent with this work.



**Figure 20.3.3.** The images show the output of NLCOMP for the granules from 22 January 2013 0259-0306 UTC.

### References

Walther, A., A. Heidinger, W. Straka, 2011: ABI algorithm theoretical basis document for DCOMP., version 2.0 NOAA/NESDIS, 61pp. [Available online at [http://www.goes-r.gov/products/ATBDs/baseline/Cloud\\_DCOMP\\_v2.0\\_no\\_color.pdf](http://www.goes-r.gov/products/ATBDs/baseline/Cloud_DCOMP_v2.0_no_color.pdf)]

Walther, A. and A. Heidinger (2012): Implementation of the Daytime Cloud Optical and Microphysical Properties Algorithm in PATMOS-x. JAMC, in press, doi:10.1175/JAMC-D-11-0108.1

## 21. The Development of the High Performance JPSS Analysis Facility for Instrument Impacts on Requirements (JAFIIR)

**CIMSS Task Leaders: Bormin Huang (PI), Allen Huang (Co-I), Mat Gunshor (Co-I), Hong Zhang (Co-I),**

**CIMSS Support Scientists: Jarno Mielikainen; Melin Huang; Abhishek Pandey**

**NOAA Collaborators: Ajay Mehta; Mitch Goldberg**

**NOAA Long Term Goal**

- Weather-Ready Nation

**NOAA Strategic Goals**

- Serve society's needs for weather and water



- Provide critical support for the NOAA mission

### **CIMSS Research Themes**

- Satellite Meteorology Research and Applications
- Satellite Sensors and Techniques
- Environmental Models and Data Assimilation

### **Proposed Work**

The proposed work is to design and implement a high performance hybrid CPU- and GPU-based analysis facility in support of JPSS. Initially the system is being designed to conduct sensor modeling, measurement simulation, and EDR algorithm adaptation so that VIIRS instrument impact assessment on system requirements can be evaluated. This work follows the successful GOES-R Analysis Facility for Instrument Impacts on Requirements project (GOES-R AWG GRAFIIR), which has so far supported 9 ABI waiver/deviation analyses.

This cost-effective system leverages efforts from project activities of 1) GOES-R AWG GRAFIIR, 2) Community Satellite Processing Package (CSPP), 3) NPP proving ground, 4) VIIRS and CrIS calibration/validation, 5) LEO Cloud Algorithm Testbed (LEOCAT), and 6) GPU-based high performance WRF model development.

Key features of the JAFIIR development approach for this project are as follows:

- JAFIIR is for “connecting the capabilities,” the components that have been built and/or are under development, to provide a flexible framework to effectively adopt component algorithms for analyzing measurements under different sensor characteristics (i.e., noise, navigation, band-to-band co-registration, diffraction, etc.) and their impacts on products;
- JAFIIR is to assess and evaluate many of the JPSS data and products (i.e., imagery, clouds, derived products, soundings, fire, SST, ocean color, aerosol, etc.) in a consistent way, to ensure that instrument effects on products can be fully accounted for, characterized and product performance optimized;
- JAFIIR is to develop high performance GPU-based radiative transfer modeling, numerical weather prediction, and time-critical analyses; these are required to support JPSS sensor simulation, sensor trade analysis, and high spatial resolution sensor measurement simulation; and
- JAFIIR is a coordinated team effort from JPSS Risk Reduction, Proving Ground and other related sensor calibration/validation projects; it will not independently develop any new algorithms or processing methods that are already available or are currently under development.

In the initial stage of development, JAFIIR will demonstrate NPP VIIRS processing chain to the show instrument impacts on the products of cloud mask, cloud property, fire, sea surface temperature, aerosol/dusts and, ultimately, many other VIIRS products. These demonstrations will use the simulation and/or proxy datasets developed by AWG proxy team and the new high-spatial resolution datasets using GPU-based high-performance forward and NWP models. The EDR/level 2 mask, cloud, wind, fire and other products algorithm required by JAFIIR will be adopted from the Algorithm Development Library (ADL) and Community Satellite Processing Package (CSPP).

JAFIIR will contribute to JPSS directly through an algorithm processing facility capable of taking into account JPSS imaging and sounding instrument effects in order to optimize product performance and meet mission requirements. Any sensor effect that has significant impacts on products can be quantified, and potential processing approaches or quality control procedures can



then be identified to minimize and mitigate the risk of failure in meeting product specification requirements.

Since 2007, through its GRAFIIR effort, CIMSS has developed an efficient facility to model specific GOES-R ABI sensor effects. CIMSS also focused on developing a framework, which leverages GEOCAT and the semi-autonomous system GLANCE. GLANCE is a tool, constructed from scientific python libraries, used for comparing complex datasets stored in hdf (ver. 4 and 5) or netCDF (ver. 3 and 4) format. GLANCE is currently used by AWG AIT team.

- GLANCE runs from the command-line on Unix-like systems, including Linux and Mac OSX, and is highly automated.
- It provides wide variety of statistics as well as HTML comparison reports, graphical charts, and geospatial imagery.
- It gives guidance about comparison tolerances, is useful for verifying the similarity of two datasets in a semi-automated way, and provides high quality output summarizing results.
- It is being integrated with GRAFIIR automation to provide summary pass/fail analyses showing areas of significant difference.
- Primarily, GLANCE has been used for comparisons between the output from the NOAA GOES-R Algorithm Integration Team's Framework (FWAIT) and output from the GOES-R Algorithm Working Groups at CIMSS.
- GLANCE is also used in conjunction with GRAFIIR to assess impacts of noise in simulated ABI data; used to check separate runs of FWAIT and other GOES-R science code for robustness; used to generate detailed statistical comparison outputs to support, this far, 9 ABI waivers/deviations.

In addition, the JAFIIR team will continue to leverage GRAFIIR to provide a flexible platform to analyze multiple inputs and outputs to demonstrate sensor impacts on many products. JAFIIR plans to use Unidata's Integrated Data Viewer (IDV), Java WebStart technology, and other existing graphics and data management software to enhance our system's analysis capability and to identify sensor components that might prohibit JPSS VIIRS (and later, CrIS and ATMS) products from meeting measurement requirements. Furthermore, JAFIIR is to leverage GPU-based CRTM/RTTOV and WRF to achieve a timely simulation of the emerging enhancements of JPSS VIIRS, CrIS and ATMS sensor capability toward improved information content; spectral, spatial, and signal to noise. This applies also to other newly identified possibilities such as cross-platform coordination over large spatial domains, and with broad spectral coverage, for instrument cross-validation and potential extraction of 3D feature information.

## Summary of Accomplishments and Findings

### ***Task 1 – JAFIIR End-to-End Infrastructure Building***

The JAFIIR project so far has demonstrated with VIIRS that an instrument effect altering calibration of a band can be simulated and that the impact on products can be determined. The capability to run more products examples with different instrument effects will continue to be grown.

- Glance expanded capabilities to read AWIPS files.
  - Working toward GEOTIFF file format.
- VIIRS radiance perturbation code being developed.
  - Can currently add a 'calibration offset' of a specified amount.
- CSPP Cloud Mask Example.
  - VIIRS 10.8um band M15 altered with 1K and 3K offsets for 3 time periods.



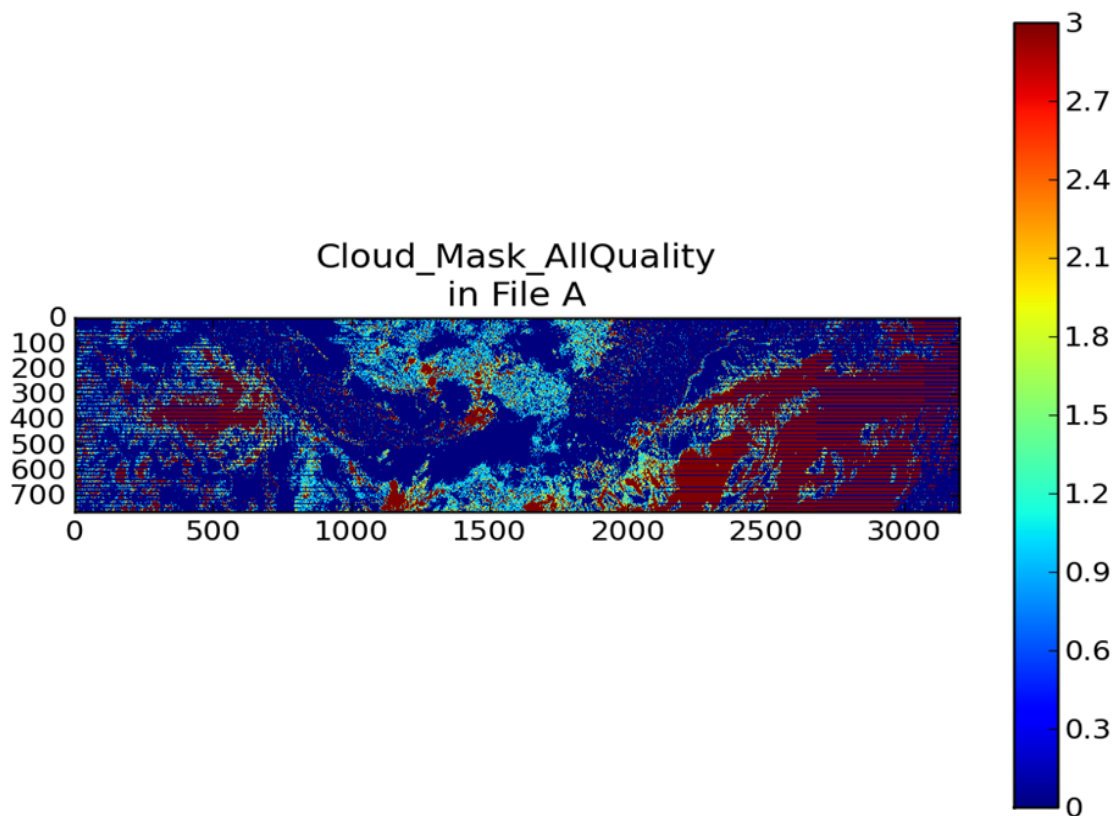
- Cloud Mask and Cloud Phase generated for original, 1K and 3K cases.
- Glance used to compare results of 1K and 3K cases to original, unaltered.

Fig. 21.1 and Fig. 21.2 demonstrate two of the image types generated by the Glance HTML report feature. The full report for this case can be seen here:

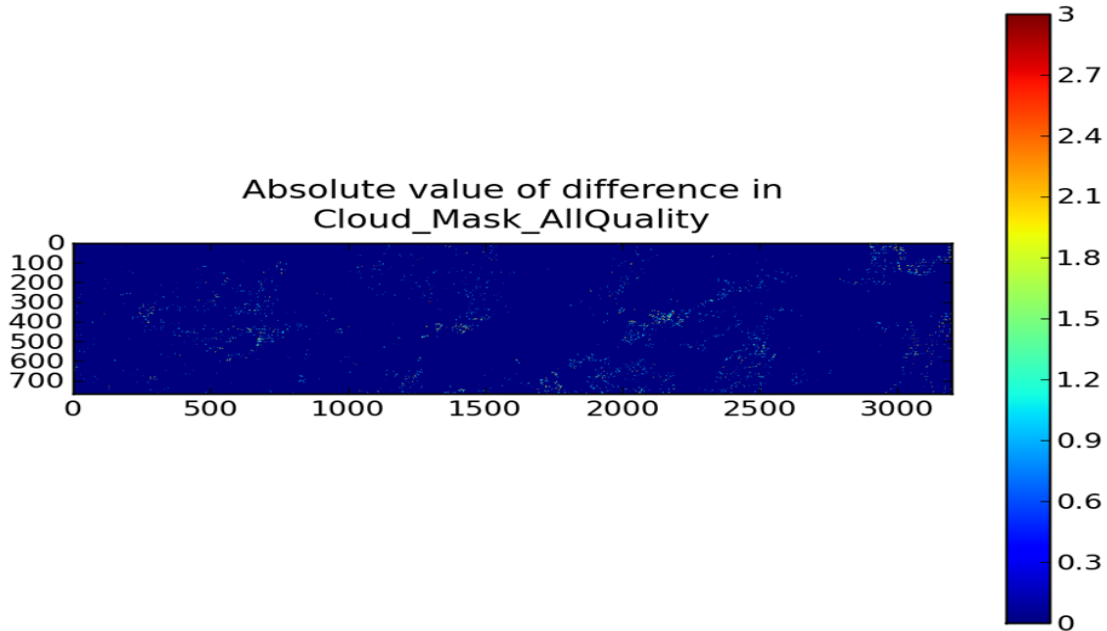
[http://www.ssec.wisc.edu/grafir/JAFIIR/VIIRS\\_CloudMask/20120217\\_t1851476\\_CalOffset1K/Cloud\\_Mask\\_AllQuality/index.html](http://www.ssec.wisc.edu/grafir/JAFIIR/VIIRS_CloudMask/20120217_t1851476_CalOffset1K/Cloud_Mask_AllQuality/index.html)

In table 1 the statistics are shown for this example case. The cloud mask has values that range between 0 and 3. A change as large as 1K in the 10.8um band can cause a significant problem for the cloud mask for some pixels, where the cloud mask classification changed 3 categories (from “probably clear” to “probably cloudy,” or vice versa). However, the overall effect on the cloud mask for this image was small with fewer than 1% of the of the pixels changing at all between the two cases. A similar case study was done with a 3K change to the 10.8um band which resulted in more differences in the cloud mask product.

The hypothetical addition of water vapor channels on VIIRS for analysis of SST and polar wind cloud heights can be addressed to assess impacts objectively and systematically.



**Figure 21.1.** Cloud mask from 17 February 2012, ~18:51UTC, generated from unperturbed VIIRS data.



**Figure 21.2.** The differences (absolute value) between the cloud mask generated with unperturbed data and with data where the 10.8um band had a 1K offset added to each pixel.

**Table 21.1.** Numerical Comparison Statistics in this 1K comparison case.

Numerical Comparison Statistics correlation\*: 0.9945

diff\_outside\_epsilon\_count\*: 23117

diff\_outside\_epsilon\_fraction\*: 0.009406

max\_delta\*: 3

max\_diff\*: 3

mean\_delta\*: 0.006733

mean\_diff\*: 0.01165

median\_delta\*: 0.000

median\_diff\*: 0.000

min\_delta\*: -2

mismatch\_points\_count\*: 23117

mismatch\_points\_fraction\*: 0.009406

perfect\_match\_count\*: 2434483

perfect\_match\_fraction\*: 0.9906

r-squared correlation\*: 0.9890

rms\_val\*: 0.000

std\_val\*: 0.1280

### **Task 2 – JAFIIR GPU WRF Development**

The core Weather Research and Forecasting (WRF) model consists of a dynamic solver and eight physics packages, namely, cloud microphysics, cumulus parameterization, long wave radiation, short wave radiation, boundary layer turbulence, surface layer, land-surface parameterization, and sub-grid scale diffusion. Each physics package also includes several modules as users' options.

We have implemented 19 physics modules in the WRF model. Achieved GPU speedups for WRF physics modules with respect to single-threaded CPU performance are listed in Table 21.2.



**Table 21.2.** Speedups for WRF physics modules.

WRF Module name	Speedup
Single moment 6-class microphysics	500x
Eta microphysics	272x
Purdue Lin microphysics	692x
Stony-Brook University 5-class microphysics	896x
Betts-Miller-Janjic convection	105x
Kessler microphysics	816x
New Goddard shortwave radiance	134x
Single moment 3-class microphysics	331x
New Thompson microphysics	153x
Double moment 6-class microphysics	206x
Dudhia shortwave radiance	409x
Goddard microphysics	1311x
Double moment 5-class microphysics	206x
Total Energy Mass Flux surface layer	214x
Mellor-Yamada Nakanishi Niino surface layer	113x
Single moment 5-class microphysics	350x
Pleim-Xiu surface layer	665x

All speedups are over 100x, which demonstrate that using GPUs for numerical weather prediction (NWP) and JPSS data assimilation will decrease computational times significantly. The number of WRF modules implemented on GPU will continue to grow. The data parallel nature of NWP is illustrated in Fig 21.3. This embarrassingly parallel nature of computation explains why GPUs are such a good match for this kind of computations. Currently, the most time consuming part of WRF, which is dynamics, is being rewritten for GPU execution. After ~20,000 lines of dynamics core are reformulated for GPU then GPU WRF module integration work can begin. After that, the whole WRF can be run on GPU for higher performance. This will greatly facilitate the JAFIR data assimilation into WRF in a timely fashion.

### Publications and Conference Reports

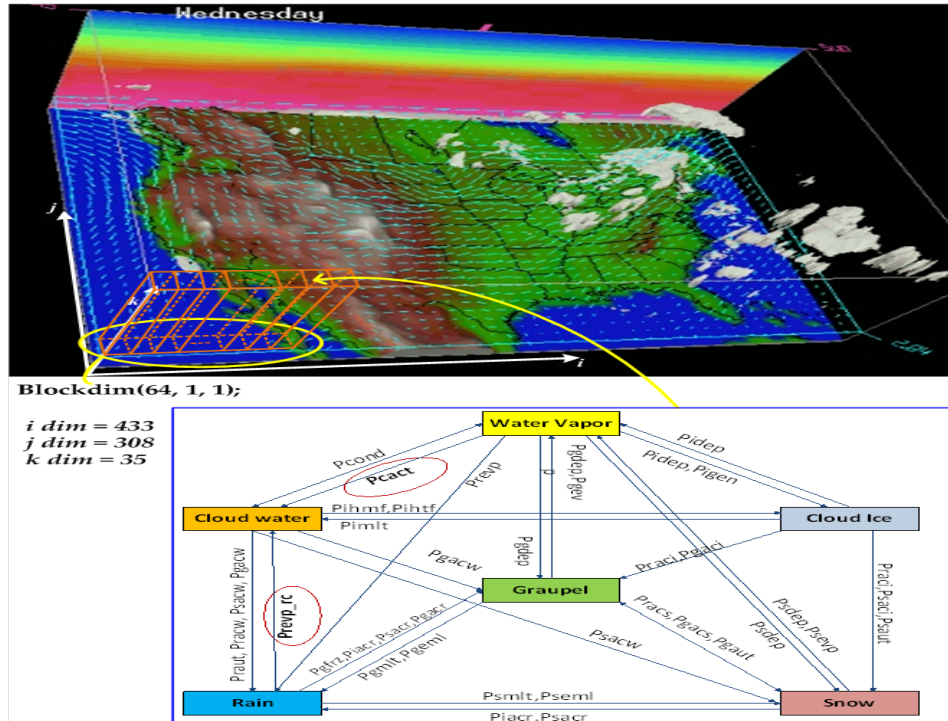
J. Mielikainen, B. Huang, A. Huang and M. Goldberg, GPU Acceleration of the Updated Goddard Shortwave Radiation Scheme in the Weather Research and Forecasting (WRF) Model, IEEE Journal of Selected Topics in Applied Earth Observations and Remote Sensing, doi: 10.1109/JSTARS.2012.2186119.

J. Mielikainen, B. Huang, A. Huang and M. Goldberg, Improved GPU/CUDA Based Parallel Weather and Research Forecast (WRF) Single Moment 5-class (WSM5) Cloud Microphysics, IEEE Journal of Selected Topics in Applied Earth Observations and Remote Sensing, doi: 10.1109/JSTARS.2012.2188780.

J. Mielikainen, B. Huang, J. Wang, A. Huang and M. Goldberg, Compute Unified Device Architecture (CUDA)-based Parallelization of WRF Kessler Cloud Microphysics Scheme, Computers & Geosciences, 2012, doi: 10.1016/j.cageo.2012.10.006.

J. Mielikainen, B. Huang, A. Huang and M. Goldberg, GPU Implementation of Stony-Brook University 5-Class Cloud Microphysics Scheme in the WRF, IEEE Journal of Selected Topics in Applied Earth Observations and Remote Sensing, 2011, doi: 10.1109/JSTARS.2011.2175707.

J. Mielikainen, B. Huang, J. Wang, A. Huang, M. Goldberg, and A. Mehta, Speeding Up the Computation of WRF Double Moment 6-Class Microphysics Scheme with GPU, submitted to Journal of Atmospheric and Oceanic Technology.



**Figure 21.3.** Parallelization of the computational domain. Domain is divided into tiles. Each tile will be handled by a separate GPU code.

J. Mielikainen, B. Huang, A. Huang, M. Goldberg, and A. Mehta, An efficient Advanced Research Weather Research and Forecast (WRF-ARW) dynamics subroutine in CUDA C, SPIE Remote Sensing, Dresden, 2013.

J. Mielikainen, B. Huang, A. Huang, M. Goldberg, and A. Mehta, Development of the many-core accelerator based Stony-Brook University 5-class microphysics scheme in the weather research and forecasting model, SPIE Remote Sensing, Dresden, 2013.

A. Pandey, J. Mielikainen, B. Huang, A. Huang, M. Goldberg, and A. Mehta, GPU based acceleration of MM5 similarity surface layer scheme in the Weather Research and Forecasting Model, SPIE Remote Sensing, Dresden, 2013.

M. Huang J. Mielikainen, B. Huang, J. Wang, A. Huang, M. Goldberg, and A. Mehta, GPU implementation of Milbradt microphysics module in WRF, SPIE Remote Sensing, Dresden, 2013.

M. Huang J. Mielikainen, B. Huang, J. Wang, A. Huang, M. Goldberg, and A. Mehta, Acceleration of Yonsei University (YSU) Planetary Layer Scheme in WRF with GPUs, SPIE Optics + Photonics, San Diego, 2013.

J. Mielikainen, B. Huang, J. Wang, A. Huang, M. Goldberg, and A. Mehta, Massively Parallel Acceleration of WRF Double Moment 5-Class Cloud Microphysics Scheme on Multiple GPUs, submitted to Parallel Processing Letters.

M. Huang J. Mielikainen, B. Huang, J. Wang, A. Huang, M. Goldberg, and A. Mehta, Acceleration of WRF 5-Layer Thermal Diffusion Module with GPU-Based Parallel Processors,



submitted to IEEE Journal of Selected Topics in Applied Earth Observations and Remote Sensing.

M. Huang J. Mielikainen, B. Huang, J. Wang, A. Huang, M. Goldberg, and A. Mehta, GPU Implementation of Yonsei University (YSU) Planetary Layer Scheme in WRF, submitted to Journal of Computational Physics.

M. Huang J. Mielikainen, B. Huang, J. Wang, A. Huang, M. Goldberg, and A. Mehta, GPU Acceleration of Goddard Cumulus Ensemble Model with Parallel Processors, submitted to IEEE Journal of Selected Topics in Applied Earth Observations and Remote Sensing.

A. Pandey, J. Mielikainen , B. Huang, A. Huang, M. Goldberg, and A. Mehta, Multi-GPU based acceleration of the Total Energy – Mass Flux surface layer scheme in the Weather Research and Forecasting Model, submitted to Concurrency and Computation: Practice and Experience.

J. Mielikainen, B. Huang, A. Huang, M. Goldberg, and A. Mehta, Utilizing many-core accelerator for computation of Goddard microphysics in the weather research and forecasting model (WRF), SPIE Optics + Photonics, San Diego, 2013.

C. Song, B. Huang, A. Huang, M. Goldberg, and A. Mehta, Scalable simulations for WRF Thompson microphysics scheme with the use of GPU parallel computing, SPIE Optics + Photonics, San Diego, 2013.

X. Wu, B. Huang, A. Huang, M. Goldberg, and A. Mehta, Exploring parallel computing paradigm for WRF single moment 3-class cloud microphysics scheme, SPIE Optics + Photonics, San Diego, 2013.

X. Li, B. Huang, A. Huang, M. Goldberg, and A. Mehta, Exploring data parallel nature of Morrison microphysics in Weather Research and Forecast (WRF) model, SPIE Optics + Photonics, San Diego, 2013.

A. Pandey, J. Mielikainen , B. Huang, A. Huang, M. Goldberg, and A. Mehta, GPU based acceleration of the Total Energy – Mass Flux surface layer scheme in the Weather Research and Forecasting Model, SPIE Optics + Photonics, San Diego, 2013.

M. Huang J. Mielikainen, B. Huang, J. Wang, A. Huang and M. Goldberg, GPU-Based parallel Implementation of 5-layer thermal diffusion scheme, Proc. SPIE 8539, High-Performance Computing in Remote Sensing II, 853908 (2012), doi:10.1117/12.978991.

M. Huang J. Mielikainen, B. Huang, J. Wang, A. Huang and M. Goldberg, On the acceleration of Eta Ferrier Cloud Microphysics Scheme in the Weather Research and Forecasting (WRF) model using a GPU Proc. SPIE 8539, High-Performance Computing in Remote Sensing II, 85390K (2012), doi: 10.1117/12.976908.

J. Wang, B. Huang, A. Huang and M. Goldberg, GPU acceleration of the WRF Purdue Lin cloud microphysics scheme, Proc. SPIE 8183, 81830R (2011); doi:10.1117/12.901825.

J. Wang, B. Huang, A. Huang and M. Goldberg, Parallel Computation of the Weather Research and Forecast (WRF) WDM5 Cloud Microphysics on a Many-Core GPU, 2011 IEEE 17th Int. Conference on Parallel and Distributed Systems, doi: 10.1109/ICPADS.2011.160.





J. Wang, B. Huang, A. Huang and M. Goldberg, Compute Unified Device Architecture (CUDA)-based parallelization of WRF Kessler cloud microphysics scheme, Proc. SPIE 8183, 81830U (2011); doi:10.1117/12.901828.

J. Mielikainen, B. Huang, A. Huang and M. Goldberg, Development of the GPU-based Stony-Brook University 5-class microphysics scheme in the weather research and forecasting model, Proc. SPIE 8183, 81830V (2011); doi:10.1117/12.901829.

J. Mielikainen, B. Huang, A. Huang and M. Goldberg, GPU acceleration of WRF WSM5 microphysics, Proc. SPIE 8183, 81830S (2011); doi:10.1117/12.901826.

## **22. The Development of a Community Satellite Processing Package (CSPP) in Support of Suomi NPP/JPSS Real Time Regional (RTR) Applications**

**CIMSS Task Leaders: Allen Huang (PI), Liam Gumley (PM)**

**CIMSS Support Scientist(s): Scott Mindock, Ray Garcia, Graeme Martin, Geoff Cureton, Kathy Strabala, Elisabeth Weisz, Nadia Smith, Nick Bearson, Jim Davies**

**NOAA Collaborator: Mitch Goldberg**

**NOAA Long Term Goals**

- Weather-Ready Nation

**NOAA Strategic Goals**

- Serve society's needs for weather and water
- Provide critical support for the NOAA mission

**CIMSS Research Themes**

- Satellite Meteorology Research and Applications
- Satellite Sensors and Techniques

### **Proposed Work**

The Community Satellite Processing Package (CSPP) supports the Direct Broadcast (DB) meteorological and environmental satellite community through the packaging and distribution of open source science software. CSPP supports DB users of both polar orbiting and geostationary satellite data processing and regional real-time applications through distribution of free open source software, and through training in local product applications.

The Suomi NPP/JPSS component of the Community Satellite Processing Package (CSPP) for DB transforms VIIRS, CrIS, and ATMS RDRs to SDRs and selected EDRs, and is optimized for real-time processing and regional applications. The CSPP Suomi NPP/JPSS software has the following capabilities:

- Ingest CCSDS packet files from VIIRS, CrIS, ATMS and NPP spacecraft diary;
- Create SDR and EDR products for VIIRS, CrIS, and ATMS using the current operational versions of the IDPS PRO algorithms and lookup tables;
- Produce all output files in the HDF5 formats defined by the JPSS Common Data Format Control Books;
- Retrieve all required dynamic non-spacecraft ancillary data automatically;
- Run natively on 64-bit Intel Linux host platforms;
- Run on Microsoft Windows and Apple OS X platforms via a Virtual Appliance;
- Allow the end user to customize which EDR products are created;



- Provide a simple algorithm chaining capability to run algorithms in sequence;
- Provide detailed logs of all processing operations and give clear indications of where and when failures occur;
- Provide products optimized for NWS which are AWIPS and/or NOAA NextGen compatible; and
- Provide value-added products for end users that are not part of the JPSS operational suite, such as images in KML format for Google Earth; Night Fog Detection; Volcanic Ash; and Aviation Safety products.

### **Summary of Accomplishments and Findings**

As of March 2013, the CSPP suite includes software for generating the following products:

- VIIRS M-band, I-band, and Day/Night band radiances, reflectances, and geolocation;
- CrIS radiances and geolocation;
- ATMS antenna temperatures and geolocation;
- CrIS, IASI, and AIRS temperature and moisture profiles and cloud-top parameters;
- VIIRS Cloud Mask and Active Fires; and
- Gridded imagery in AWIPS and GeoTIFF formats.

New products in testing for release as part of CSPP in the next 6 months include:

- VIIRS Sea Surface Temperature, Aerosol Optical Thickness and Vegetation Index;
- VIIRS, AVHRR, and MODIS Cloud Top Parameters from CLAVR-X;
- VIIRS and MODIS single-band and multi-band (true color) projected GeoTIFF and JPEG images; and
- ATMS products from the Microwave Integrated Retrieval System (MIRS).

Value added features for Suomi NPP products provided in CSPP include aggregation of multiple granules into one granule per satellite overpass, internal compression of HDF5 product files, and automatic run-time downloading of any required dynamic ancillary data.

The CSPP software for Suomi NPP is based on the Algorithm Development Library (ADL) developed by Raytheon and the JPSS project. This means that the CSPP software is the same software that runs in the operational processing facility at NOAA/NESDIS. SSEC/CIMSS has packaged the software to run from the Linux command line in real-time direct broadcast mode, but we have not changed the underlying processing software, algorithms, or data formats. The output files from the CSPP SDR processing software are identical in naming, format, and structure to the corresponding files from NOAA/NESDIS. The native format for NPP SDR products is HDF5, and descriptions of the NPP file formats are available in the “Common Data Format Control Books.”

The CSPP project created the following software releases during the reporting period.

*February 22, 2013*

*CSPP VIIRS SDR GeoTIFF and AWIPS Reprojection Software Version 1.0.*

First release of software to create reprojected GeoTIFFS and/or AWIPS netCDF-3 files from Visible Infrared Imaging Radiometer Suite (VIIRS) Science Data Record (SDR) HDF5 files. AWIPS stands for the Advanced Weather Interactive Processing System, the visualization and analysis tool used by the US National Weather Service.



*February 8, 2013*

*CSPP Suomi NPP VIIRS Cloud Mask and Active Fires EDR Software Version 1.0.*

First release of Visible Infrared Imaging Radiometer Suite (VIIRS) instrument Environmental Data Record (EDR) software that uses VIIRS SDRs as input and produces VIIRS Cloud Mask and Active Fires HDF5 output files. This software is designed to work with the VIIRS SDR V1.3 algorithms.

*February 8, 2013*

*CSPP Suomi NPP CrIS, VIIRS and ATMS SDR Software Version 1.3.*

New version of the calibration and geolocation Science Data Record (SDR) software for the Visible Infrared Imaging Radiometer Suite (VIIRS), Advanced Technology Microwave Sounder (ATMS), and the Cross-track Infrared Sounder (CrIS) instruments that uses Algorithm Development Library 4.1, and is compatible with the first CSPP VIIRS EDR release. This release replaces existing installations of CSPP SDR (it is not an update).

*November 26, 2012*

*CSPP CrIS, AIRS and IASI Dual Regression Retrieval Software Version 1.0.*

First release of a core software package that uses input Suomi NPP CrIS, Aqua AIRS or Metop IASI radiances and retrieves vertical profiles of temperature, moisture, ozone as well as cloud and surface properties at single field-of-view resolution. The dual regression technique was developed at the University of Wisconsin-Madison.

*October 4, 2012*

*CSPP Suomi NPP CrIS, VIIRS and ATMS SDR Software Version 1.2.*

Update to the calibration and geolocation Science Data Record (SDR) software for the Visible Infrared Imaging Radiometer Suite (VIIRS), Advanced Technology Microwave Sounder (ATMS), and the Cross-track Infrared Sounder (CrIS) instruments. This release includes many updates to the software, including using Algorithm Development Library 4.0, updates to the science algorithms, as well as additional options to aggregate and compress SDR granules. This release replaces existing installations of CSPP SDR (it is not an update).

*May 4, 2012*

*CSPP CrIS UW Retrieval Software Version 1.0.*

First release of CrIS Environmental Data Records software created at the University of Wisconsin-Madison that retrieves atmospheric temperature and moisture profiles as well as surface and cloud properties using a dual-regression technique. The inputs are CrIS Science Data Records (SDRs) and GDAS or GFS forecast files, which are automatically identified and retrieved.

*May 2, 2012*

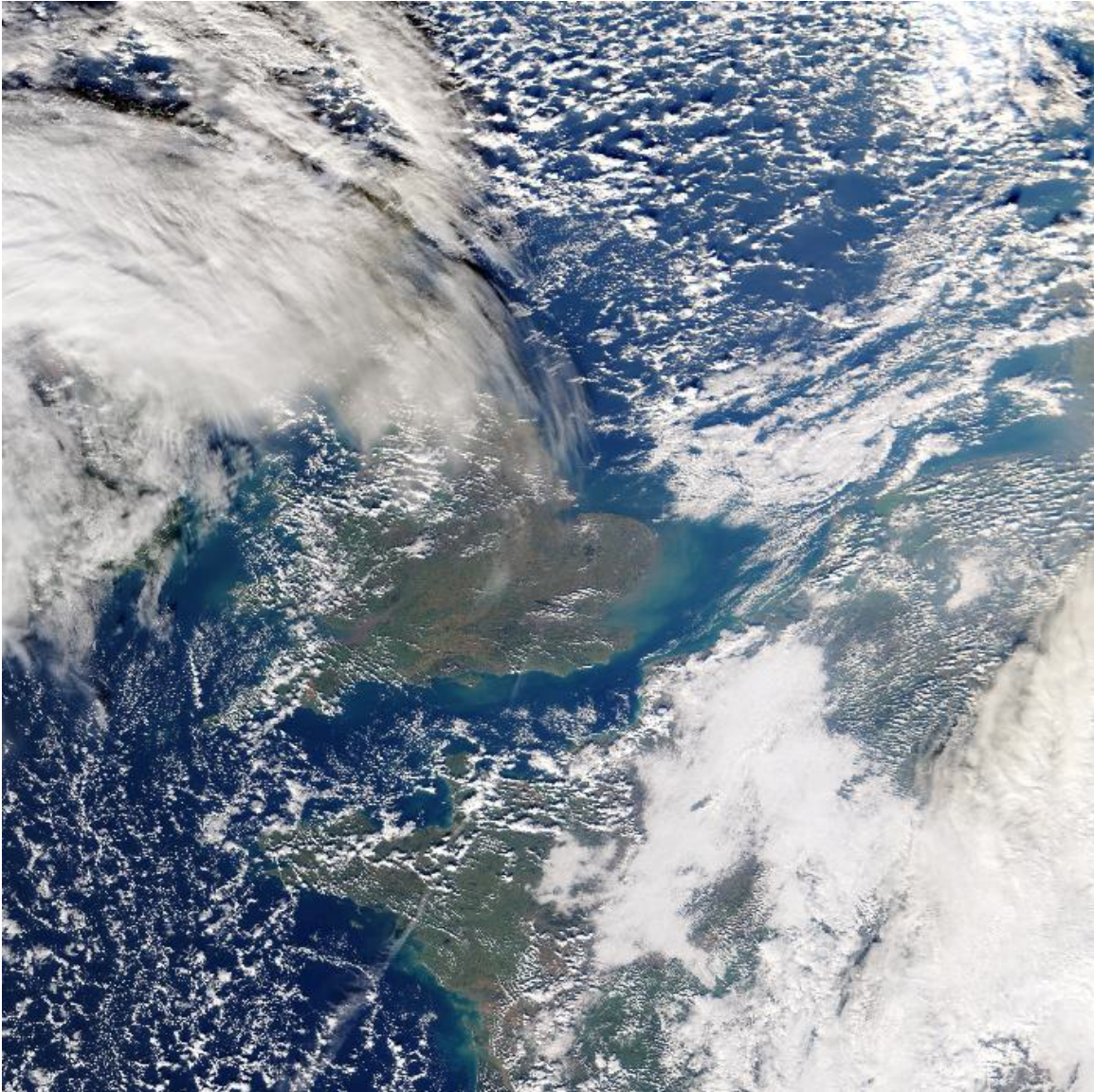
*CSPP Suomi NPP CrIS, VIIRS and ATMS SDR Software Version 1.1.*

First public release of software for transforming direct broadcast Cross-track Infrared Sounder (CrIS) instrument Raw Data Records (RDRs) to calibrated and geolocated Science Data Records (SDRs). Also included in this release are updates to the Visible Infrared Imaging Radiometer Suite (VIIRS) and Advanced Technology Microwave Sounder (ATMS) RDR to SDR software packages. Documentation, calling scripts and test data are included in the distribution.

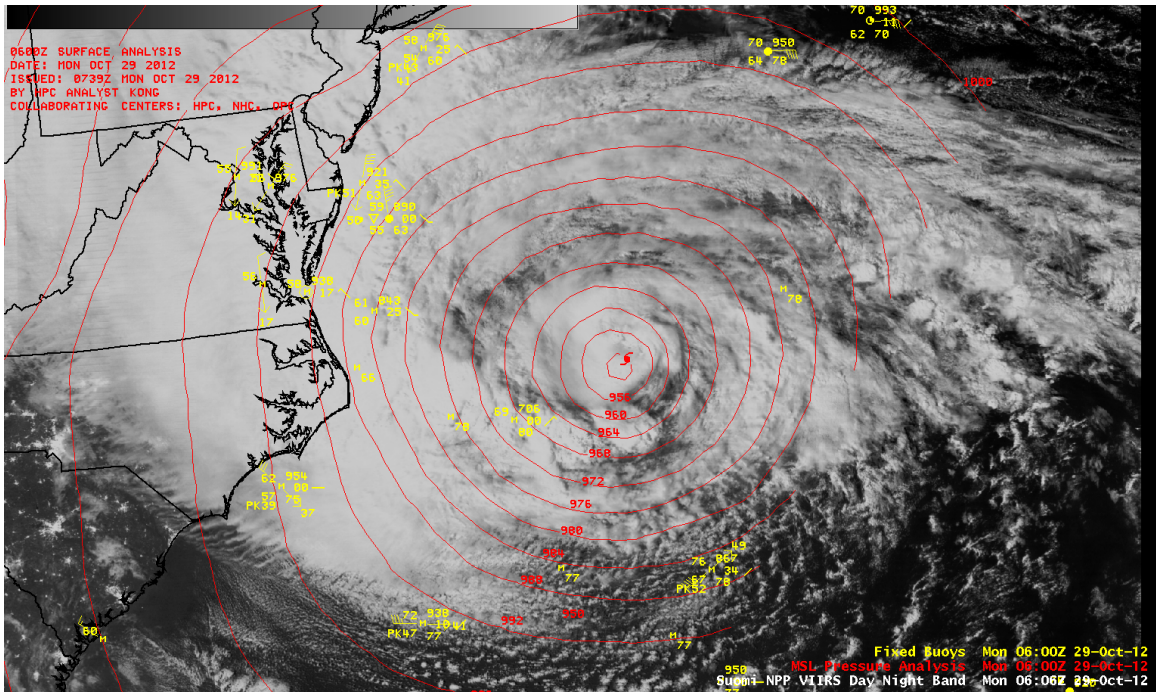
CSPP has enabled rapid dissemination of Suomi NPP imagery and products to the National Weather Service, using data acquired by direct broadcast at UW-Madison, University of Hawaii, and the University of Alaska-Fairbanks. CSPP SDR is also facilitating rapid assimilation of



Suomi NPP CrIS and ATMS data by weather services including the UK Met Office, German Meteorological Service, Meteo France and national agencies including CONABIO, INPE, ACRES, and CSIR.



**Figure 22.1.** VIIRS true color image processed by CSPP and acquired by direct broadcast from Suomi NPP by the UK Met Office (courtesy Nigel Atkinson).



**Figure 22.2.** VIIRS Day/Night Band Imagery of Hurricane Sandy acquired by direct broadcast at SSEC and processed by CSPP.

### 23. SSEC/CIMSS Participation on the Algorithm Development Library (ADL) Team

**CIMSS Task Leader:** Liam Gumley

**CIMSS Support Scientists:** Scott Mindock, Ray Garcia, Graeme Martin, Geoff Cureton, Kathy Strabala, Jim Davies

**NOAA Collaborator:** Pat Purcell

#### NOAA Long Term Goals

- Weather-Ready Nation

#### NOAA Strategic Goals

- Serve society's needs for weather and water
- Provide critical support for the NOAA mission

#### CIMSS Research Themes

- Satellite Meteorology Research and Applications
- Satellite Sensors and Techniques

#### Proposed Work

SSEC/CIMSS proposes continue to support the JPSS project as a member of the Algorithm Development Library (ADL) Team. SSEC/CIMSS will support the ADL project by:

- Acting as the release point for ADL to the JPSS user community,
- Maintaining the ADL Web site and User Forum,
- Providing user support for installing and operating ADL,
- Providing training material and courses for end users of ADL,
- Developing and enhancing the Virtual Appliance distribution of ADL,
- Developing an ingest and pre-processing capability for dynamic ancillary data in ADL,
- Verifying compatibility with RDRs from Direct Broadcast sources,



- Checking compatibility of Direct Broadcast produced SDRs with the corresponding IDPS SDRs, and
- Verifying robustness of ADL distributions before public release.

SSEC/CIMSS will work closely with the Raytheon ADL development team and the JPSS project to ensure that ADL meets the needs of users who wish to execute and modify IDPS PRO algorithms outside the operational IDPS environment.

### **Summary of Accomplishments and Findings**

1. SSEC/CIMSS released ADL 4.0 to the user community in July 2011. ADL 4.1 followed in October 2011. The releases were available in two formats: (a) source code as delivered by Raytheon, with explicit instructions developed by SSEC/CIMSS for installing prerequisite packages and building the software, and (b) a 64-bit Linux virtual appliance where all prerequisites are installed and ADL is built and ready to run.
2. SSEC/CIMSS evaluated robustness of ADL software before public release. Defects were found in the compilation of non-debug mode version of ADL 4.0. These defects were reported to Raytheon Team. The Raytheon Team repaired the defects before public release, saving end users time and money.
3. SSEC/CIMSS investigated methods for improving VIIRS SDR performance by leveraging different platform and compiler combinations. Results of this investigation to were reported to ADL users at the ADL workshop in November of 2012.
4. SSEC/CIMSS supplied Raytheon with patch for improved ADL compatibility with more recent versions of the GCC compiler. Raytheon incorporated many of the changes into the 12 2012 Raytheon patch.
5. SSEC/CIMSS developed and supplied instructions for updating the virtual appliance to leverage Raytheon patches made available in the Common CM environment.
6. SSEC/CIMSS released the updated version of the ShellB3 Python library for working with ADL executable and data files, and supplied this package to the ADL team at Raytheon.
7. SSEC/CIMSS released updated ancillary data including calibration LUTS required for SDR processing.
8. SSEC/CIMSS continued to develop and refine the ADL Web site for documentation and user instructions and the ADL Forum for user interaction. The Web site is available at

<https://jpss-adl-wiki.ssec.wisc.edu>

and includes information on ADL Software and Downloads, Installation Instructions, Scripts and Helper Applications, ADL Virtual Appliance, HOWTOs, Add-Ons, and a link to the ADL help desk email address. The Web site also contains links to the ADL ancillary data Web site.

9. The ADL Virtual Appliance (VA), built on 64-bit Ubuntu Linux, continued to be a popular method for end users to download, install and run ADL. The ADL VA allows end users who may not have access to a configurable Linux system (e.g., users in the NOAA security zone) a way to get started with ADL using a Windows host computer. The ADL Virtual Appliance functions



identically to a native Linux install of ADL, and provides all the functionality of the ADL build and run environment.

10. The ShellB3 Python scripting environment released by SSEC/CIMSS provides a portable pre-built library of read-to-run utility scripts for assisting with common tasks in ADL, including:

- Reading and writing HDF5 and BLOB files,
- Converting native ancillary data formats (e.g., GRIB) to BLOB format,
- BLOB read-write access (big and little endian),
- ASC metadata manipulation,
- Ancillary data gridding and granulation, and
- HDF5 file comparisons (e.g., for comparing output files from different versions of a retrieval algorithm).

11. SSEC/CIMSS developed and is operating a real-time ancillary data ingest and distribution site to provide a one-stop shop for ADL users to obtain the ancillary data needed to run SDR and EDR algorithms in ADL. The Web site is available at <http://jpsdb.ssec.wisc.edu/ancillary/>. Files distributed include:

- GFS model NPP grib2 forecast files,
- GDAS model grib2 analysis files,
- NISE Snow and Ice Extent HDF4 files,
- NAAPS aerosol forecast grib2 files,
- Polar Wander Blob and ascii files,
- TLE internal text and ascii files, and
- LUTs needed for SDR processing.

#### **Publications and Conference Reports**

SSEC/CIMSS participated in the ADL workshop held at NASA GSFC in January, 2012. Status of the ADL effort at UW-Madison/SSEC/CIMSS was presented by Scott Mindock.

SSEC/CIMSS participated in the ADL workshop held at NASA GSFC in November, 2012. Results of VIIRS SDR performance effort at UW-Madison/SSEC/CIMSS was presented by Scott Mindock.

#### **24. Science and Management Support for NPP VIIRS Snow and Ice EDRs**

**CIMSS Task Leader: Yinghui Liu**

**CIMSS Support Scientist: Xuanji Wang**

**NOAA Collaborator: Jeffrey R. Key**

##### **NOAA Long Term Goals**

- Climate Adaptation and Mitigation
- Weather-Ready Nation

##### **NOAA Strategic Goals**

- Serve society's needs for weather and water
- Provide critical support for the NOAA mission

##### **CIMSS Research Themes**

- Satellite Meteorology Research and Applications



## Proposed Work

The Visible Infrared Imaging Radiometer Suite (VIIRS) provides the majority of the Environmental Data Records (EDR) on the Suomi National Polar-orbiting Partnership (NPP; formerly the NPOESS Preparatory Project) satellite. Cryosphere (snow and ice) products are fundamental to weather prediction, hazard detection, transportation, recreation, and climate monitoring, and are therefore an important part of the suite of VIIRS EDRs.

NESDIS/STAR is taking the managerial and technical leadership of NPP and Joint Polar Satellite System (JPSS) cryosphere product development and evaluation activities. The JPSS Cryosphere Team will produce snow and ice Environmental Data Records (EDRs) from visible, infrared, and microwave data. For the purposes of this proposal, however, only those EDRs produced from VIIRS are considered. The VIIRS snow and ice EDRs are sea ice characterization, ice surface temperature, and snow cover/depth. Sea ice characterization includes an ice concentration intermediate product (IP).

The Cryosphere Team is a unified combination of Subject Matter Experts (SMEs) from academia and government. Scientists from the Cooperative Institute for Meteorological Satellite Studies (CIMSS) at the University of Wisconsin-Madison are an integral part of the team. Research at CIMSS focuses on the sea ice EDRs, in collaboration with colleagues at the Cooperative Institute for Research in the Environmental Sciences (CIRES) at the University of Colorado-Boulder. Snow cover research is being conducted at the Cooperative Remote Sensing Science and Technology Center (CREST)/City College of New York (CCNY).

## Summary of Accomplishments and Findings

This report covers the period from 1 April 2012 to 31 March 2013. Work at CIMSS focused on obtaining VIIRS SDRs, IPs, and EDRs automatically from the GRAVITE system, evaluating the quality of these SDRs and EDRs, and collocating and performing comparisons of these IPs and EDRs with other satellite, reanalysis, and in situ observational datasets. The SDRs include VIIRS moderate resolution band SDRs, VIIRS image band SDRs, and corresponding terrain-corrected geolocation SDRs. The IPs include VIIRS ice concentration IP, VIIRS ice reflectance and temperature IP, VIIRS ice quality flag IP, VIIRS ice weights IP, and VIIRS cloud mask IP. The EDRs include VIIRS ice surface temperature EDR, VIIRS sea ice characterization EDR, VIIRS cloud cover and layers EDR. Our accomplishments and findings include:

- An automated validation system for VIIRS ice products has been developed to routinely acquire in situ ice data, ice products from various satellite sensors and reanalysis data, and VIIRS products. This tool automatically collocates VIIRS products with other products, does statistic analysis for the collocated VIIRS ice products and other products, plots all the products and presents all the products on the Web site maintained at CIMSS, and archives all the analysis results and plots since July 2012. An example is shown in Figure 24.1;
- Comparisons of collocated VIIRS ice surface temperature with MODIS ice surface temperature product and NCEP surface air temperature show that VIIRS ice surface temperature are in general agreement with other two products in spatial distributions over both Arctic and Antarctic. Preliminary comparisons of VIIRS ice concentration with SSM/I sea ice concentration show general agreement over both the Arctic and Antarctic. At present, the VIIRS sea ice concentration is biased high in certain regions when compared to passive microwave products; ice surface temperature has a cold bias in contrast to the measurements from the IceBridge aircraft campaign and MODIS operational products; and the sea ice characterization algorithm performs better during daytime than at nighttime; and

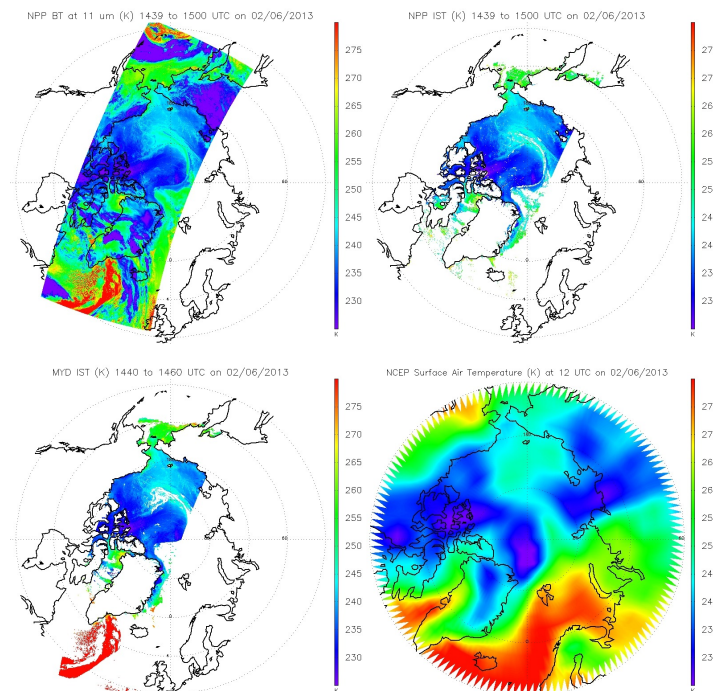




- Cloud cover products from VIIRS and MODIS show significant differences. Compared to MODIS, VIIRS tends to identify less cloud in the Arctic, and more cloud over the area with high altitude in the Polar Regions.

Most of the last seven months has been spent on a previously unanticipated task: evaluating the mechanics and quality of the VIIRS snow/ice gridding procedure and the resulting Snow/Ice Rolling Tiles product. Other EDRs, notably the VIIRS Cloud Mask, use the Snow/Ice Rolling Tiles to determine the locations of snow and ice. The gridding process updates this snow/ice background by incorporating recent information from the Ice Concentration IP and the Snow Cover EDR, when and where available.

The VIIRS granule-to-grid process shows substantial room for improvement due to the cloud contamination and other issues in the process of producing the sea ice concentration IP and gridding this IP to snow/ice global snow/ice rolling tiles. Three data pulls have been done in an attempt to improve this process. A local granule-to-grid running environment similar as the operational process has been set up to facilitate these attempts. Some recommendations for improving the gridding process have been provided.



**Figure 24.1.** NPP VIIRS 11 micron Brightness (upper left) Temperature, and ice surface temperature from NPP VIIRS EDR (upper right) and MODIS Aqua products (lower left), and NCEP surface air temperature (lower right) on February 6, 2013.

#### Publications and Conference Reports

Liu Yinghui, Key R. Jeffrey, Wang Xuanji, On the Arctic sea ice, clouds and the atmosphere interactions from satellite observations. (talk), 2012 Earth Observation and Cryosphere Science, 13 - 16 November 2012, Frascati, Italy.



Liu, Y., J. R. Key, Z. Liu, X. Wang, and S. J. Vavrus, 2012: A cloudier Arctic expected with diminishing sea ice. *Geophys. Res. Lett.*, **39**, L05705, doi:10.1029/2012GL051251.

Wang, X., J. Key, Y. Liu, Arctic Climate Change: Trends in Surface, Cloud, Radiation, and Sea Ice Properties from Satellite Data (Talk), 2012 IPY Conference: From Knowledge To Action, April 22-27, 2012, Montreal, Canada.

Wang, X., J. Key, Y. Liu, Arctic Sea Ice Changes, Interactions, and Feedbacks on the Arctic Climate during the Satellite Era (Invited talk), 2011 AGU Fall Meeting, 5-9 December 2011, San Francisco California, USA.

Liu, Y., J. Key, X. Wang, Understanding the interactions and feedbacks between Arctic sea ice, clouds, and the atmosphere from satellite observations, (keynote talk), 2011 EUMESAT meteorological satellite conference, September 5-9, 2011, Oslo, Norway.

Wang, X., J. Key, Y. Liu, Arctic Sea Ice Properties and Changes from Satellite Data over the Period 1982-2010 (Talk), 2011 EUMETSAT Meteorological Satellite Conference, 5-9 September 2011, Oslo, Norway.

Wang, X., J. R. Key, and Y. Liu, 2010: A thermodynamic model for estimating sea and lake ice thickness with optical satellite data. *J. Geophys. Res.*, **115**, C12035, 14 PP., 2010, doi:10.1029/2009JC005857.

Liu, Y., J. R. Key, and X. Wang, 2009: The influence of changes in sea ice concentration and cloud cover on recent Arctic surface temperature trends. *Geophys. Res. Lett.*, **36**, L20710, doi:10.1029/2009GL040708.

Fernandes, R., H. Zhao, X. Wang, J. R. Key, X. Qu, and A. Hall, 2009: Controls on Northern Hemisphere snow albedo feedback quantified using satellite Earth observations. *Geophys. Res. Lett.*, **36**, L21702, doi:10.1029/2009GL040057.

## **25. Sea Ice Thickness from Aqua and Terra Data Acquisition, Evaluation and Applications**

**CIMSS Task Leader: Xuanji Wang**

**CIMSS Support Scientist: Yinghui Liu**

**NOAA Collaborator: Jeffrey R. Key**

**NOAA Long Term Goals**

- Climate Adaptation and Mitigation
- Weather-Ready Nation

**NOAA Strategic Goals**

- Serve society's needs for weather and water
- Understand climate variability and change to enhance society's ability to plan and respond
- Provide critical support for the NOAA mission

**CIMSS Research Themes**

- Satellite Meteorology Research and Applications
- Satellite Sensors and Techniques



## Proposed Work

This project focuses on the estimation of sea ice thickness using our newly developed One-dimensional Thermodynamic Ice Model (OTIM) (Wang et al., 2010) with satellite-derived forcing fields, and the one using Lagrangian tracking method (Fowler et al., 2004) that was developed at the University of Colorado (CU) by our collaborators, which calculates ice age first and then generates a proxy thickness dataset based on age vs. thickness relationships (Maslanik et al., 2007) will also be used for the comparison purpose. The main goals of this project are to:

- Develop and evaluate improved datasets suitable for investigating and predicting interannual, global and regional variability in ice thickness and volume;
- Use these products to assess fundamental changes in sea ice thickness, volume and age; and
- Demonstrate the utility of these data for evaluating the performance of sea ice simulations within a state-of-the-art climate model.

To meet the goals, tasks fall into two categories: (1) product generation, evaluation and accuracy assessment, and (2) applications to study spatial and temporal variabilities in ice thickness over a long time period, and to relate these variabilities to various climate forcings. Research at CIMSS focuses on the estimation of ice thickness from optical (visible/infrared) sensors such as AVHRR, MODIS, and VIIRS.

## Summary of Accomplishments and Findings

This project started in December 2011. This report covers the period from 1 March 2012 to 30 March 2013. During this period, specific tasks included:

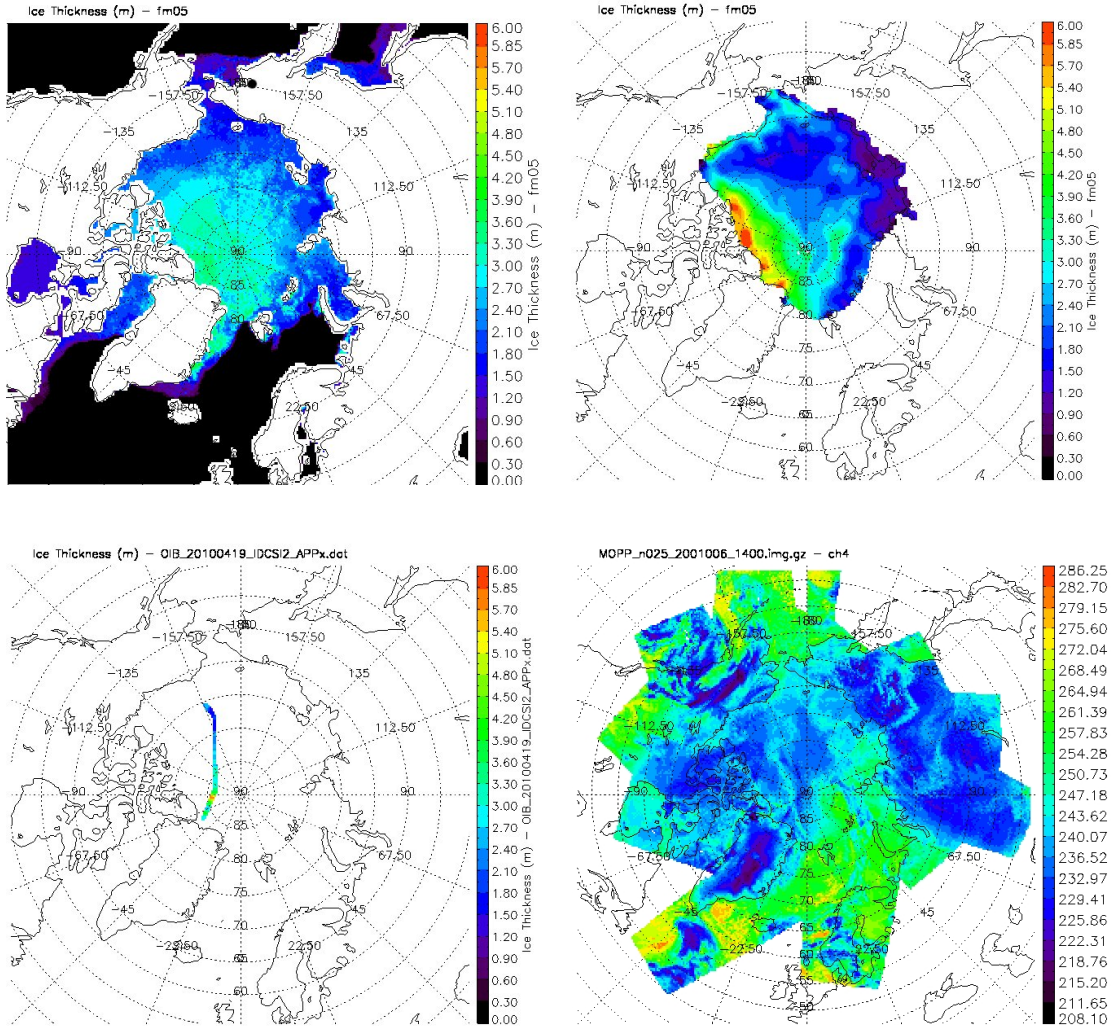
- All MODIS data starting from 2000 to 2012 have been collected for the Arctic, daily composites of MODIS data at local solar times of 04:00 and 14:00 have been generated on the EASE grid with channel, cloud, and ice surface temperature information for the generation of MODIS sea ice thickness dataset;
- APP-x data now cover the period of 1982 ~ 2011;
- One-dimensional Thermodynamic Ice Model (OTIM) for use with MODIS Terra & Aqua composite data has been further improved and modified, and is undergoing processing to generate MODIS sea ice thickness dataset over 2000 ~ 2012;
- ICESat retrieved sea ice thickness data (Kwok et al., 2009) over 2003 ~ 2008 from Ron Kwok have been remapped to the EASE grid for the evaluation study, and the preliminary comparison between ICESat and OTIM with APPx data has been done;
- IceBridge retrieved sea ice thickness data over 2009 ~ 2011 have been collected and remapped to the EASE grid for the evaluation study, and the comparisons between IceBridge and OTIM with both APPx and MODIS data are undergoing now; and
- Two papers have been published and three conference presentations have been given.

The OTIM results compare well with in-situ measurements and reasonably well with ICESat thicknesses and CU ice age. Four datasets from AVHRR, MODIS, ICESat, and IceBridge have been collected and/or generated with updated algorithms and dates as mentioned above. Figure 25.1 shows examples of the above four data sources for the Arctic.

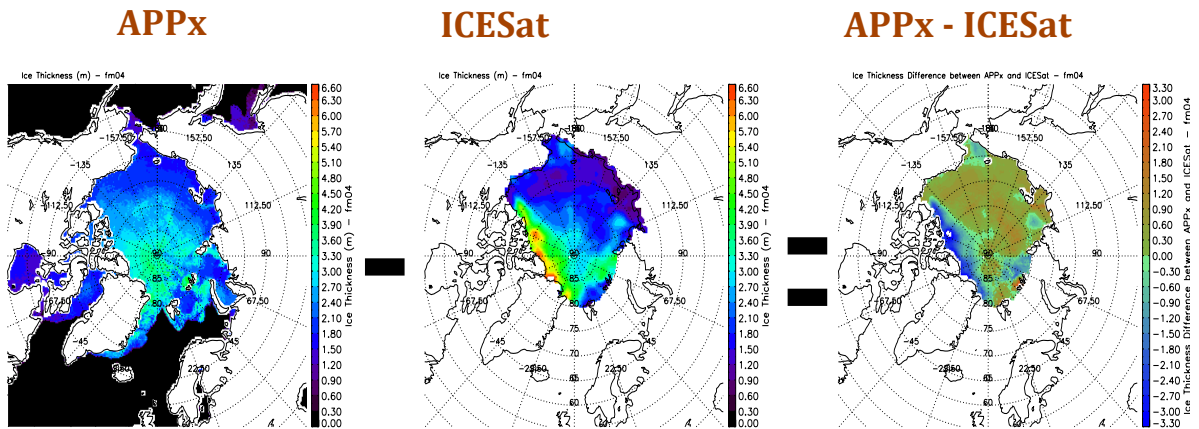
The OTIM ice thickness and age products are unique in being derived by forcing an energy balance model using satellite products. The U.W. group is now involved in refining and extending the product and, as part of this grant, assessing how their data compare to the thickness and age products from the Kwok and CU groups. In addition to comparing with CU-derived ice thickness as in the first year report, such comparisons have also been done between OTIM and



ICESat (Figure 25.2). The fact that there is some correspondence between the data given that the two methods are independent is encouraging.

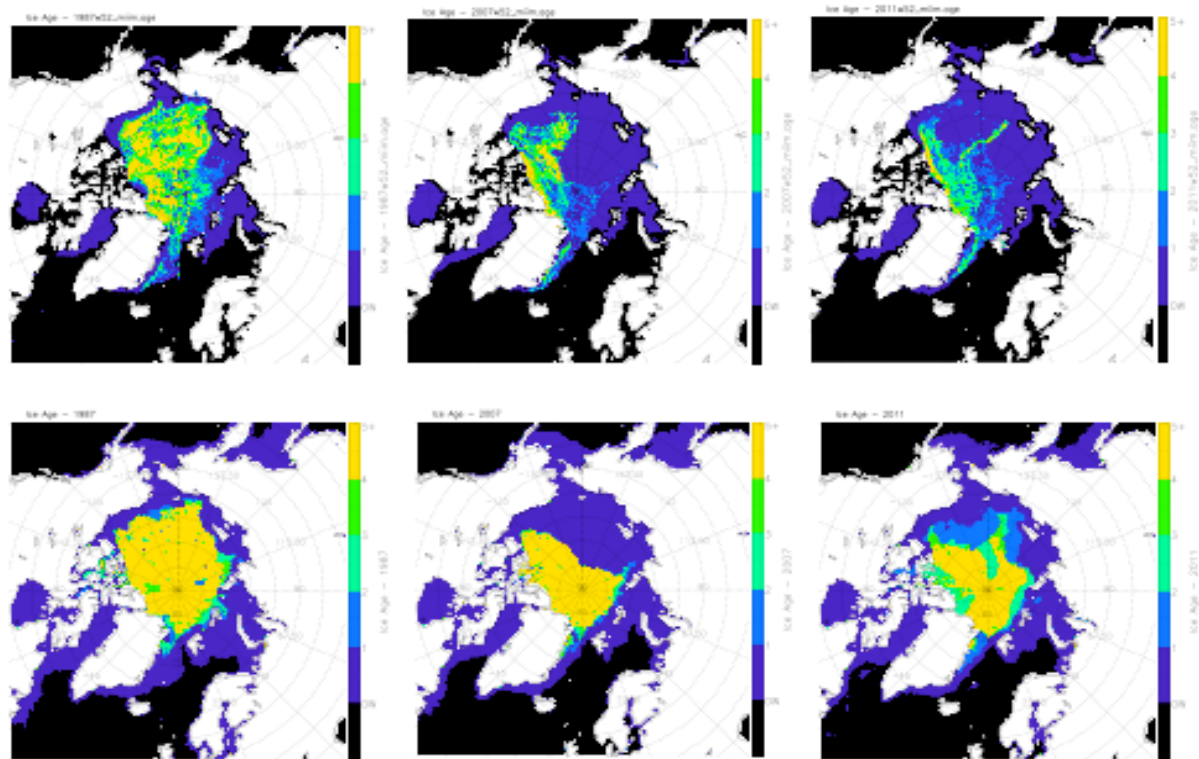


**Figure 25.1.** Sea ice thickness fields generated by OTIM with AVHRR data (upper-left) and ICESat altimeter data (upper-right) for the period of Feb 17-Mar 24, 2005., and IceBridge altimeter data (lower-left) for the 19<sup>th</sup> day of April, 2001. An example of MODIS daily composites for the band 31 (equivalent to AVHRR channel 4) brightness temperature is also shown here (lower-right).



**Figure 25.2.** Comparisons between APP-x and ICESat in sea ice thickness for the periods of Feb 17-Mar 21, 2004. The mean absolute bias between them is 0.689932 m.

Figure 25.3 shows the comparison in sea ice age between two different approaches of which one is CU Lagrangian method that actually tracks an individual ice pack overtime, the other one is UW Eulerian method that monitors the temporal persistence of a location covered by ice.



**Figure 25.3.** Sea ice age for the years of 1987, 2007, and 2011 (Top line from Lagrangian tracking method (CU), bottom line from Eulerian tracking method (UW), both using SSM/I data) in terms of ice age classification (0=open water, 1=first-year ice, 2=second-year ice, 3=third-year ice, 4=fourth-year ice, 5=fifth or more year ice).



## Publications and Conference Reports

Wang, Xuanji, Jeffrey Key, Yinghui Liu, Charles Fowler, James Maslanik, and Mark Tschudi, 2012, Arctic Climate Variability and Trends from Satellite Observations, *Advances in Meteorology*, Vol. 2012, Article ID 505613, 22 pages, doi:10.1155/2012/505613.

Liu, Y., J. R. Key, Z. Liu, X. Wang, and S. J. Vavrus, 2012: A cloudier Arctic expected with diminishing sea ice. *Geophys. Res. Lett.*, **39**, L05705, doi:10.1029/2012GL051251.

Wang, Xuanji, Jeffrey R. Key, Yinghui Liu, Sea Ice Estimation and Inter-comparisons from Different Satellite Data, 2012 Earth Observation and Cryosphere Science, 13 - 16 November 2012, Frascati, Italy.

Wang, Xuanji, Jeffrey R. Key, Yinghui Liu, Understanding Arctic Sea Ice and Climate Changes from Satellite Observations (Talk), 2012 EUMETSAT Meteorological Satellite Conference, 3-7 September 2012, Sopot, Poland.

Wang, Xuanji, Jeffrey R. Key, Yinghui Liu, Arctic Climate Change: Trends in Surface, Cloud, Radiation, and Sea Ice Properties from Satellite Data (Talk), 2012 IPY Conference: From Knowledge To Action, April 22-27, 2012, Montreal, Canada.

## References

Fowler, C., W. J. Emery, and J. Maslanik, 2004. Satellite-derived evolution of Arctic sea ice age: October 1978 to March 2003. *IEEE Geoscience and Remote Sensing Letters* **1** (2): 71-74, doi:10.1109/LGRS.2004.824741.

Kwok, R., G. F. Cunningham, M. Wensnahan, I. Rigor, H. J. Zwally, and D. Yi, 2009, Thinning and volume loss of the Arctic Ocean sea ice cover: 2003–2008, *J. Geophys. Res.*, **114**, C07005, doi:10.1029/2009JC005312.

Maslanik, J. A., C. Fowler, J. Stroeve, S. Drobot, J. Zwally, D. Yi, and W. Emery, 2007, A younger, thinner Arctic ice cover: Increased potential for rapid, extensive sea-ice loss, *Geophys. Res. Lett.*, **34**, L24501, doi:10.1029/2007GL032043.

Xuanji Wang, Jeffrey Key, and Yinghui Liu, 2010, A thermodynamic model for estimating sea and lake ice thickness with optical satellite data, *J. Geophys. Res.*, **115**, C12035, doi:10.1029/2009JC005857.

## 26. Implementation of GCOM-W1 AMSR2 Snow Products

**CIMSS Task Leader: Yong-Keun Lee**

**NOAA Collaborator: Jeffrey R. Key, Cexar Longoli (CICS)**

### NOAA Long Term Goals

- Climate Adaptation and Mitigation
- Weather-Ready Nation

### NOAA Strategic Goals

- Serve society's needs for weather and water
- Understand climate variability and change to enhance society's ability to plan and respond
- Provide critical support for the NOAA mission



## **CIMSS Research Themes**

- Satellite Meteorology Research and Applications

### **Proposed Work**

The Advanced Microwave Scanning Radiometer 2 (AMSR2) is the next generation of the AMSR-E instrument that is currently on NASA's Aqua satellite. AMSR2 is on the Japan Aerospace Exploration Agency (JAXA) Global Change Observation Mission 1st – Water (GCOM-W1) satellite. GCOM-W1 was launched in May 2012. NOAA is supporting work with AMSR2 as part of the Joint Polar Satellite System (JPSS) program.

Monitoring of cryosphere, and in particular of the Earth's snow cover, is among primary applications of the AMSR2 instrument. AMSR2 cryosphere environmental data records (EDRs) are Ice Characterization, Snow Cover/Depth, and Snow Water Equivalent (SWE). Snow Cover/Depth includes a binary snow/no snow mask and the depth of snow on land. Snow Water Equivalent is the liquid equivalent depth of the snow cover.

The objectives of this project include assessing the suitability of heritage snow algorithms, algorithm selection, implementation, testing and validation, and routine product generation with AMSR2 data. The selected heritage algorithms will be modified as necessary. The assessment of the algorithm performance as well as the development of the data processing and product generation system will be conducted using observations from AMSR-E onboard Aqua as a proxy for GCOM AMSR2.

### **Summary of Accomplishments and Findings**

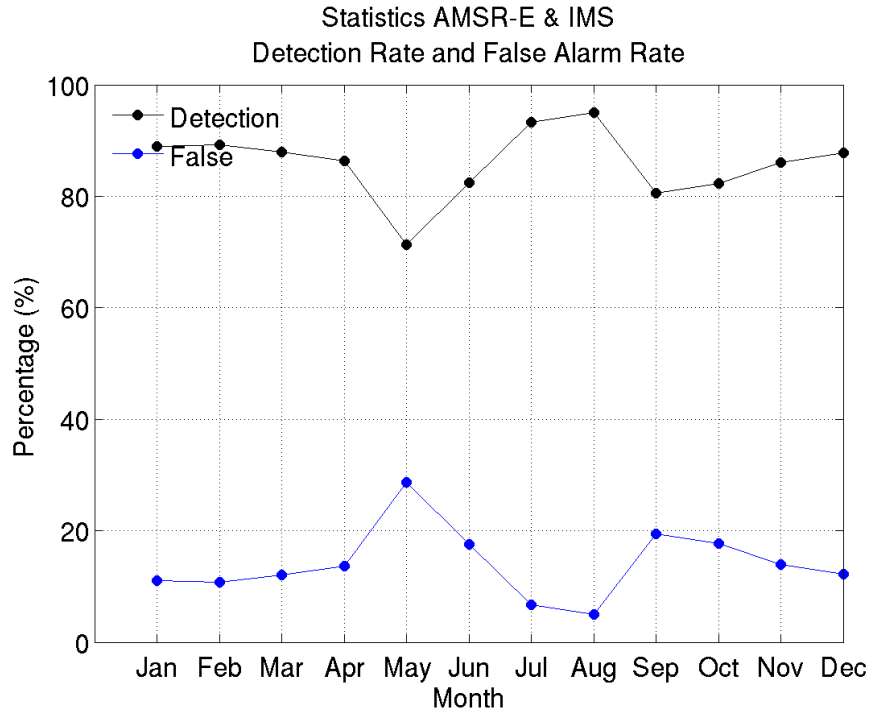
Snow cover is one of the most dynamic hydrological variables on the Earth's surface and it plays a key role in the global energy and water budget. The ability to detect global snow cover and measure snow depth in nearly all weather conditions has been shown using satellite passive microwave measurements such as the Scanning Multi-channel Microwave Radiometer (SMMR), the Special Sensor Microwave Imager (SSM/I), and the Advanced Microwave Scanning Radiometer for the Earth Observing System (AMSR-E). Unfortunately, AMSR-E on NASA's Aqua satellite stopped functioning on October 4, 2011. The Advanced Microwave Scanning Radiometer 2 (AMSR2) instrument launched on May 18, 2012 onboard the Global Change Observation Mission 1st - Water "SHIZUKU" (GCOM-W1) satellite. From an operational and functional perspective, it will replace the AMSR-E instrument.

The suite of AMSR2 algorithms that is being developed for the retrieval of snow cover and snow depth using AMSR-E data as a proxy is comprised of well-established methods. They are being modified, as necessary, to adapt them to AMSR2 and to improve their accuracy. The snow cover detection algorithm is based on a brightness temperature-based decision tree approach (Grody, 1991; Grody and Basist, 1996) with additional climatology tests as enhancements. The snow depth algorithm is based on a dynamic empirical approach (Kelly, 2009) blended with a routine for dry/wet snow differentiation. Retrieval and validation cases will also be provided.

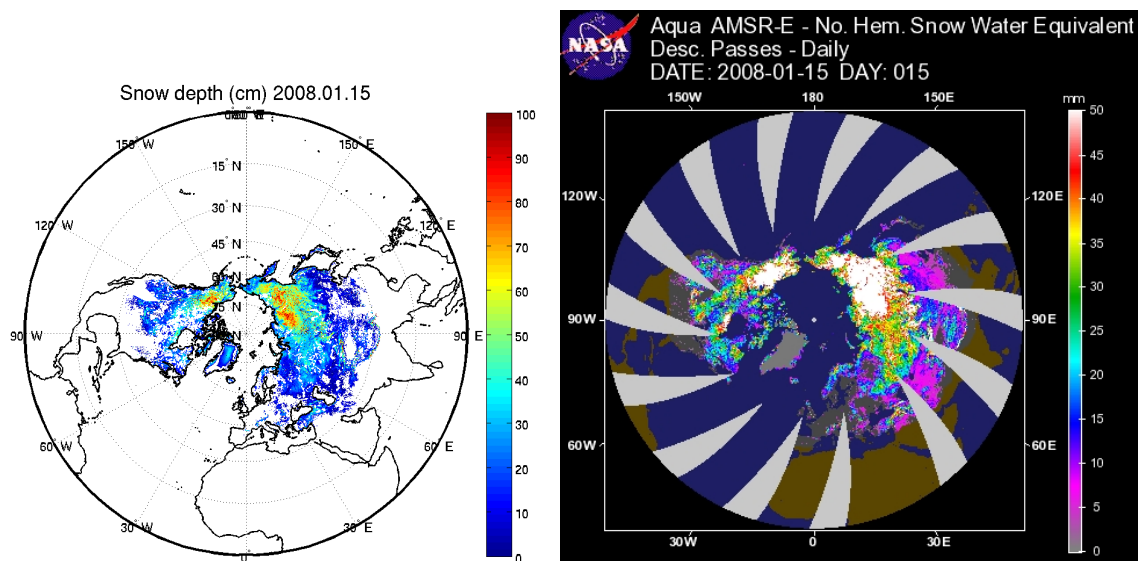
Preliminary validation results are encouraging. Figure 26.1 shows the accuracy of the snow detection algorithm applied to AMSR-E data when compared to the Interactive Multisensor Snow and Ice Mapping System (IMS) as "truth." The correct detection rate is generally above 80%. Based on this result, the product will meet the system requirements. Figure 26.2 gives a qualitative comparison of snow depth with the Kelly (2009) algorithm and the NASA snow water equivalent algorithm. While these are different parameters, they are related through the snow density. Spatial patterns in the two products are similar.



During the next project year we will refine the snow detection and snow depth methodologies and develop the snow water equivalent algorithm. Climatological snow density data will be obtained. All algorithms will then be applied to AMSR2 data, which recently became available.



**Figure 26.1.** Snow detection/false alarm rate of AMSR-E with Grody’s algorithm compared to IMS snowcover for every 15<sup>th</sup> day of each month in 2008.



**Figure 26.2.** Snow depth from AMSR-E (Kelly’s algorithm, left) and NASA AMSR-E snow water equivalent product (right) on 15 January 2008. The two products show similar spatial patterns and variability.





## Publications and Conference Reports

Lee, Y.-K., C. Kongoli, and J. R. Key, 2012: Snow cover detection and snow depth algorithms for the Global Change Observation Mission (GCOM) AMSR2 instrument. AGU 45<sup>th</sup> annual fall meeting, San Francisco, CA, December 3-7 2012.

## References

Grody, N. C. (1991), Classification of snow cover and precipitation using the special sensor microwave imager, J. Geophys. Res., 96 (D4), pp 7423-7435.

Grody, N. C., and A. N. Basist, (1996), Global identification of snowcover using SSM/I measurements, IEEE Trans. Geosci. Remote Sens., 34 (1), pp 237-249.

Kelly, R. (2009), The AMSR-E snow depth algorithm: description and initial results, J. Remote Sensing Soc. Japan, 29 (1), pp 307-317.

## 27. Detection and Characteristics of the Aurora from VIIRS on Board the Suomi NPP

**CIMSS Task Leader: S. Ackerman**

**CIMSS Support Scientists: T. Jasmin, Eric Tobias (undergraduate student)**

**NOAA Collaborator(s): Tim Schmit**

### NOAA Long Term Goals

- Weather-Ready Nation

### NOAA Strategic Goals

- Serve society's needs for weather and water
- Understand climate variability and change to enhance society's ability to plan and respond
- Support the nation's commerce with information for safe, efficient and environmentally sound transportation

### CIMSS Research Themes

- Satellite Meteorology Research and Applications
- Education and Outreach

## Proposed Work

The VIIRS instrument onboard the Suomi NPP satellite is able to observe auroras at nighttime using the day-night band (or DNB) (e.g., Lee et al., 2006). The primary goal of this project is to develop an algorithm to detect aurora regions using VIIRS observations.

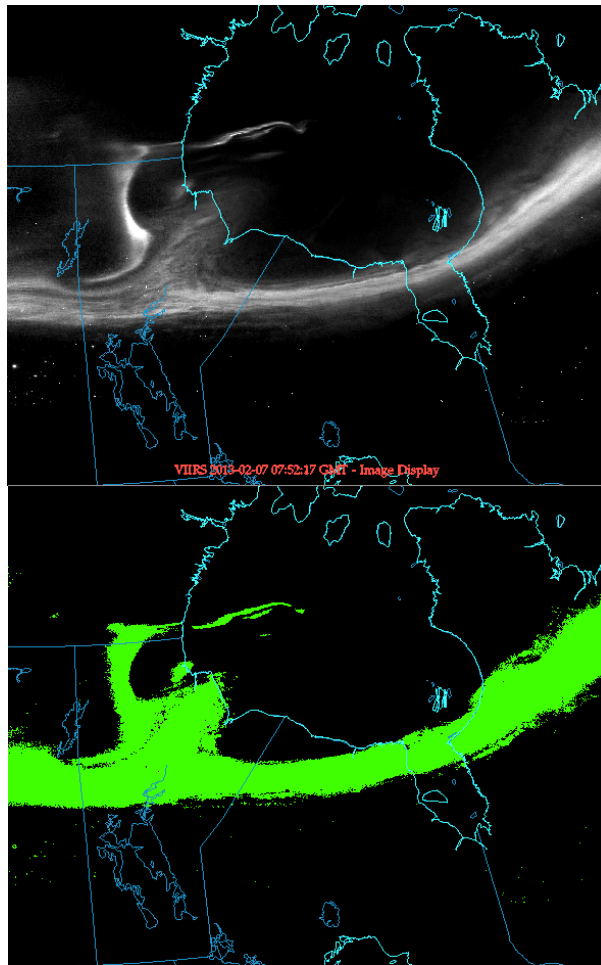
## Summary of Accomplishments and Findings

We have analyzed numerous cases and locations where the aurora occurred and utilized McIDAS-V software to interpret data from the Suomi NPP DNB (.7 micron). An example image of an aurora that occurred on February 7, 2013 is shown in Figure 27.1 (top). The goal is to combine the DNB with the 11 and 3.7 micron bands to develop a method of masking the region with the aurora. These bands were selected as:

- The DNB is able to observe the aurora phenomenon along with both high and low clouds;
- The 11.45 micron IR band can detect high cloud features, but is unable to “see” the aurora signature; and



- The 11-3.7 micron band, or “fog/stratus product,” can detect low clouds and fog but is also unable to “see” the aurora.



**Figure 27.1.** A) the DNB over Canada and the Hudson Bay on February 13, 2013. B) The green region represents the aurora mask that corresponds to 1a.

The current masking, which uses McIDAS-V, makes use of the DNB observations only and works well for cloud free conditions as demonstrated in Figure 27.1 (bottom). The undergraduate student (Eric Tobias) is working on his Senior Thesis to develop this mask.

### References

Lee, Thomas E., Steven D. Miller, F. Joseph Turk, Carl Schueler, Richard Julian, Steve Deyo, Patrick Dills, Sherwood Wang, 2006: The NPOESS VIIRS Day/Night Visible Sensor. *Bull. Amer. Meteor. Soc.*, **87**, 191–199. doi: <http://dx.doi.org/10.1175/BAMS-87-2-191>

## 28. CIMSS Science Support for the S4 Supercomputer

**CIMSS Task Leader: Jason Otkin**  
**CIMSS Support Scientist: Allen Lenzen**  
**NOAA Collaborator: R. Bradley Pierce**



### **NOAA Long Term Goals**

- Weather-Ready Nation

### **NOAA Strategic Goals**

- Serve society's needs for weather and water

### **CIMSS Research Themes**

- Satellite Meteorology Research and Applications
- Environmental Models and Data Assimilation

### **Proposed Work**

In 2011, NOAA/NESDIS/STAR provided the University of Wisconsin-Madison funds to purchase and construct a supercomputer system capable of running NCEP operational data assimilation and forecast modeling systems. The new supercomputer system, named Super Computer for Satellite Simulation and Data Assimilation Studies (S4), will support efforts to enhance existing data assimilation techniques with the ultimate goal of improving the U.S. operational forecast models. In support of these efforts, CIMSS scientists will collaborate with NOAA and JCSDA scientists to exchange ideas and gain knowledge on porting the operational software to S4, running benchmarking tests to assess the consistency of model output and demonstrating that the S4 system can be used as an experimental surrogate for the NCEP operational system.

### **Summary of Accomplishments and Findings**

During the past year, CIMSS scientists have provided support to ongoing JCSDA and NESDIS efforts to port and benchmark the operational Global Data Assimilation System (GDAS) on S4. Model verification software was installed and tested on S4 using data from an earlier GDAS run. A monitoring system was developed to quickly identify which nodes on S4 are free, being used, or in an error state. With help from this diagnostic tool, it was found that a previously installed version of the Hurricane WRF (HWRF) model was causing nodes to crash and stay off-line. Several errors in the HWRF processing scripts were identified and removed, thereby improving the uptime and efficiency of the S4 system.

To support hurricane modeling and assimilation studies, the 2012 version of the operational HWRF model was obtained from the Developmental Testbed Center and ported to S4. Several modifications were made to the configure files and PERL scripts to permit compilation on S4. Most of the “kick” scripts used to start the next job in the assimilation/forecast cycle were modified to create the proper run environment. Other modifications were made to the Parallel Operating Environment (POE) emulation script and the HWRF job submission script. Extra logic was added to the job submission scripts to allow jobs to be run on either the serial nodes or the MPI nodes. This option improves run-time performance since there are often idle CPUs available on the serial nodes.

After successfully compiling the HWRF model and obtaining necessary initialization and observation files, several assimilation/forecast tests in both cycling and non-cycling mode were performed for Hurricane Nadine (September 2012) and Hurricane Sandy (October 2012). Ongoing work includes aligning the benchmarking efforts with NCEP operations to ensure that all components of the HWRF are functioning properly and to verify the proper cold start and cycling procedures.



## **29. Implementation of Advanced Data Assimilation Techniques and Performance of Forecast Impact Assessment Experiments**

**CIMSS Task Leader: James Jung**

**NOAA Collaborators: Sid Boukabara, Lars Peter Riishojgaard and James Yoe**

**NOAA Long Term Goals**

- Weather-Ready Nation

**NOAA Strategic Goals:**

- Serve society's needs for weather and water
- Support the nation's commerce with information for safe, efficient and environmentally sound transportation

**CIMSS Research Themes:**

- Satellite Meteorology Research and Applications
- Environmental Models and Data Assimilation

### **Proposed Work**

#### ***S4 and JIBB Software Integration***

NESDIS and the Joint Center for Satellite Data Assimilation (JCSDA) have purchased computers dedicated to satellite data assimilation. The various National Oceanic and Atmospheric Administration (NOAA) forecast models and data assimilation systems are currently running on them. We are currently involved in ensuring the GDAS/GFS is setup and continues to run properly on both the JIBB and S4 computers. We will continue to work to transition to new versions of the GDAS/GFS and ensure it is as similar as possible to NCEP operations. We also plan to continue to work with NCEP to develop a standardized GDAS/GFS validation package which will help ensure results from JIBB and S4 are similar to those generated by NCEP.

#### ***Data Impact Studies***

Seven new data denial experiments will be conducted in the priority order directed by the JCSDA which is: 1) rawinsondes, 2) AMSU-A, 3) AMSU-B and MHS, 4) hyperspectral infrared (AIRS and IASI), 5) all geostationary and polar atmospheric motion vectors, 6) Global Positioning System-Radio Occultation (GPSRO), 7) all aircraft data will be conducted this year. The tasks defined here are based on the assumption that we will complete all satellite denials as quickly as possible, then diagnose impacts similar to Zapotocny et al., 2007 (a and b) and Jung et al., 2008. Verification techniques will consist of anomaly correlations and forecast impacts similar to those used by Zapotocny et al., 2007 (a and b) and Jung et al., 2008 unless directed otherwise by the JCSDA. All experiments will be conducted at a resolution of T574L64 using the May 2011 version of the GDAS/GFS on the JCSDA computer (JIBB). The experiments will consist of 45 days during the summer and winter extreme seasons. The first 14 days will not be used in the impact statistics to allow the forecast model to adjust to the missing data. We will run the 00Z GFS out to 7 days for our comparisons.

The impact of each data type will be assessed by comparing the analyses and forecasts based on an observing system using all operational data types (control). All of the denial experiments will be compared to this control experiment.



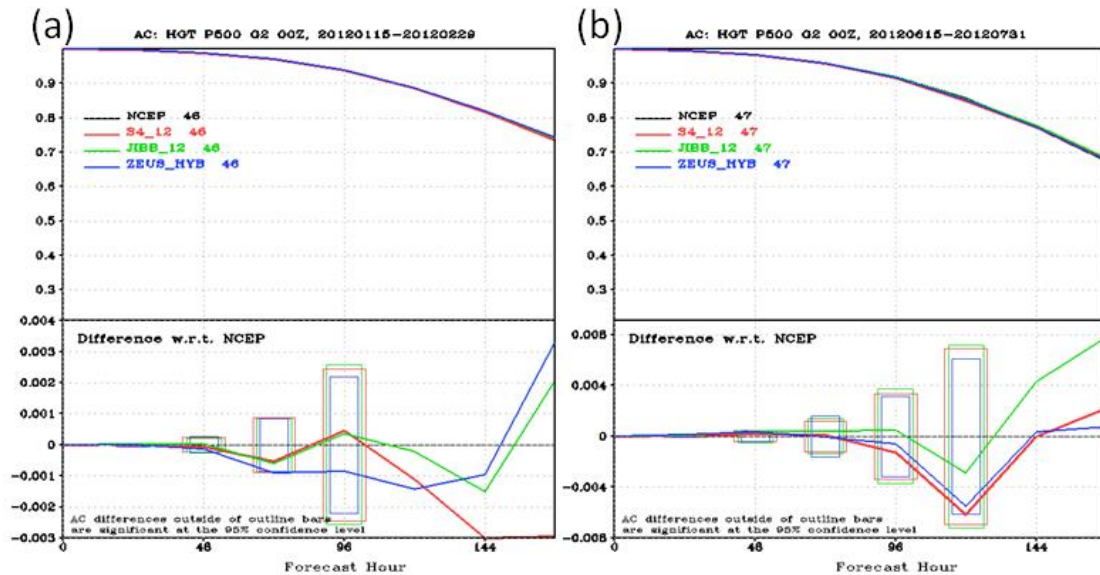
## Summary of Accomplishments and Findings

### ***S4 and JIBB Software Integration***

In May 2012 NCEP moved to a new version of the GDAS/GFS which included an 80 member ensemble. Installing this version on S4 and JIBB took longer than usual due to the extra software and the added complexity of the ensembles. The validation and verification of this version followed similar protocols as the previous installation. This validation consisted of cycled experiments of two months during two seasons. Comparisons were made between Zeus (NOAA/R&D), S4 (NESDIS) and JIBB (NASA) computers. JIBB and S4 used a May 2012 version of the NCEP operational GDAS with modifications for Linux. NCEP is responsible for installing and maintaining the GDAS on Zeus. All three computers used the GDAS operational resolution of T574L64. A one month spin up was used before each season to allow the bias corrections to adjust. S4 and JIBB meet some requirements to use various restricted distribution observations (Aircraft Communications Addressing and Reporting System (ACARS), Aircraft Meteorological Data Relay (AMDAR) and Mesonet data). The restriction flag was modified so the data could be used on S4 and JIBB when appropriate. Zeus is able to use all of the restricted data. This allowed Zeus to use a few more observations than S4 or JIBB.

The design of this experiment was to mimic NCEP operations as much as possible. However, differences with NCEP operations were necessary to allow for different machine architecture and operating systems. All of the data files used were from the NCEP operations database. This database was developed in real time and has the real time data cutoff requirements incorporated. All data used by the operational system, except some of the restricted data, were used. The GDAS/GFS was started with the same initial files on each machine. The GDAS/GFS then used its previous forecast as the background field for the next cycle's analysis on each machine. This allowed compiler and machine round off differences to influence each step of the GDAS cycles. At each 00Z cycle, the 7-day forecast was spawned and was consistent with the NCEP Central Operations (NCO) early data cutoff times. This is commonly referred to as the GFS portion of the GDAS/GFS. The case studies chosen consist of ~45-day periods during January – February 2012 and June – July 2012.

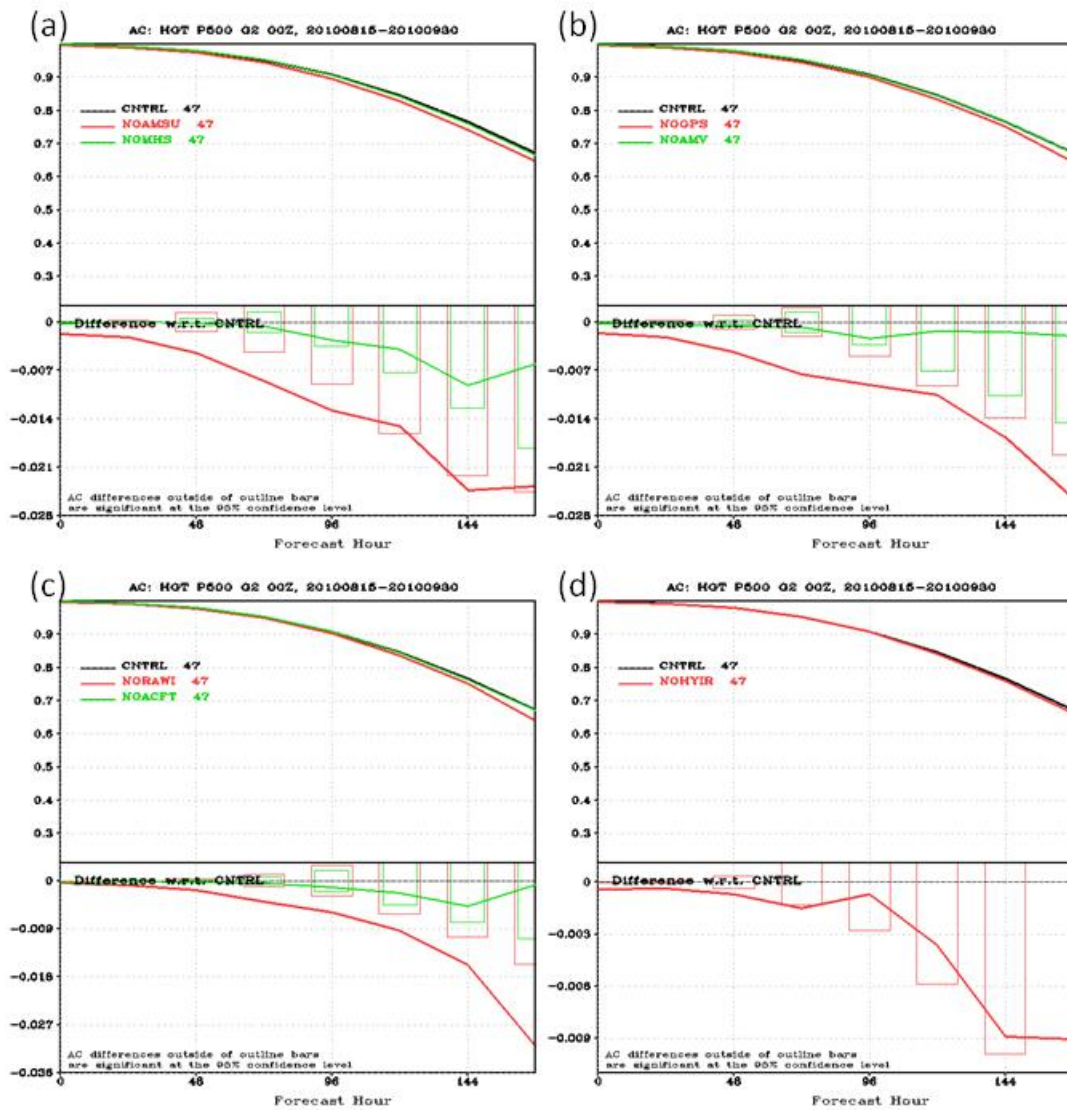
The main verification package used for this inter-comparison is the Verification Statistics Data Base (VSDB) developed by NCEP. The VSDB generates and plots time series, 1D and 2D fields, and long term average statistics for various parameters. The most common weather forecast model performance benchmarks are the mid-latitude (20-80° N/S) anomaly correlations. The day-to-day variation in the anomaly correlation time series plots between the three computers (not shown) is minimal. Obtaining almost the same value each day on the Zeus, JIBB and S4 computers suggests the day-to-day forecast skill is very similar. The 500 and 1000 hPa die-off curves for both Hemispheres in Figure 29.1 confirm that these forecast skill trends are consistent through all seven forecast days. Most of the forecast differences are not significant at the 95% level, suggesting the three computers are generating similar forecasts.



**Figure 29.1.** Global 500 hPa geopotential height anomaly correlation die-off curves from (a) January – February 2012 and (b) June – July 2012. NCEP operations, S4, JIBB and Zeus are plotted in black, red, green and blue respectively. The top section is the anomaly correlation for forecast day 0 to day 7. The bottom section is the difference with respect to NCEP operations and the significance test. Lines that are inside the same color boxes indicate the difference is not significant. Missing boxes means they were too large to plot on this scale and differences are not significant.

### Data Impact Studies

The sensor/component data denial experiments directed by the JCSDA are: 1) rawinsondes, 2) AMSU-A, 3) AMSU-B and MHS, 4) hyperspectral infrared (AIRS and IASI), 5) all geostationary and polar atmospheric motion vectors, 6) Global Positioning System-Radio Occultation (GPSRO), 7) all aircraft data. All experiments were conducted at a resolution of T574L64 using the May 2011 version of the GDAS/GFS on JIBB. The experiments consist of 45 days during the summer and winter extreme seasons. The first 14 days are not used in the impact statistics to allow the forecast model to adjust to the missing data. We ran the 00Z GFS out to 7 days for our comparisons. The impact of each data type is assessed by comparing the analyses and forecasts based on an observing system using all operational data types (control). Global anomaly correlation statistics from denying the various sensor data are shown in Figure 29.2. The top sections of each panel are the seasonal average anomaly correlation scores. The bottom sections are the difference with respect to the control and the significance test. Lines that are outside the same color boxes are significant at the 95% confidence level. These plots are at 500 hPa for August – September 2010. In general, removing the individual sensors AMSU-A, rawinsondes, or GPS-RO have an overall significant degrading impact on the global forecast skill. Also, as a general rule, removing either AMSU-A, GPS-RO or rawinsondes has a significant short term RMS impacts on temperature and geopotential height (not shown). The removal of AMSU-A or GPS-RO has a significant negative short term RMS impact on upper tropospheric relative humidity possibly due to a degraded temperature field (not shown).



**Figure 29.2.** Global 500 hPa geopotential height anomaly correlation die off curves from 15 August to 30 September 2010 for the various denial experiments. The control (CNTRL) is shown in black on each panel. The denial experiments are (a) AMSUA (NOAMSU) in red, and MHS (NOMHS) in green, (b) GPS-RO (NOGPS) in red and Atmospheric Motion Vectors (NOAMV) in green, (c) rawinsondes (NORAWI) in red and aircraft data (NOACFT) in green and (d) hyperspectral infrared (NOHYIR) in red.

### Publications and Conference Reports

Jung, J. A. and L. P. Riishojgaard, 2012: Observing System Experiments Using the NCEP Global Data Assimilation System. 5<sup>th</sup> International WMO Workshop on the Impact of Various Observing Systems on Numerical Weather Prediction. Sedona AZ, 22-23 May 2012.

Jung, J. A. and L. P. Riishojgaard, 2012: Observing System Experiments Using the NCEP Global Data Assimilation System. 10<sup>th</sup> Annual JCSDA Workshop. Riverdale MD, 10-12 Oct 2012.



Jung, J. A. And L. P. Riishojgaard, 2013: Observing System Experiment Impacts from Conventional and Satellite data using the NCEP Global Data Assimilation System. 93<sup>rd</sup> Annual AMS Meeting, Austin TX, 6-10 January 2013.

Jung, J. A. and L. P. Riishojgaard, 2013: Observing System Experiment Impacts from Various Satellite Instruments using the NCEP Global Data Assimilation System. 93<sup>rd</sup> Annual AMS Meeting, Austin TX, 6-10 January 2013.

Riishojgaard, L. P., J. G. Yoe, E. M. Devaliere, A. Pratt, K. J. Garrett, J. A Jung, S. Nolin and S. Sinno, 2013: S4 and JIBB: Building the infrastructure for an Effective O2R and a Streamlined R2O. 93<sup>rd</sup> Annual AMS Meeting, Austin TX, 6-10 January 2013.

Le Marshall, J. F., J. Jung, R. Norman, J. Lee, P. Gregory, and R. G. Seecamp, 2013: Earth Observation from Space –Advancing Earth System Science. 93<sup>rd</sup> Annual AMS Meeting, Austin TX, 6-10 January 2013.

Lim, A., J. A. Jung, A. Huang, and S. Ackerman, 2013: Assimilation of AIRS radiances using GSI/WRF for Short Term Regional Forecasts. 93<sup>rd</sup> Annual AMS Meeting, Austin TX, 6-10 January 2013.

Nebuda, S., J. A. Jung, D. A. Santek, J. M. Daniels, and W. Bresky, 2013: GOES-R AWG Atmospheric Motion Vectors: First look at assimilation in the NCEP GFS. 93<sup>rd</sup> Annual AMS Meeting, Austin TX, 6-10 January 2013.

## References

Jung, J. A., T. H. Zapotocny, J. F. Le Marshall and R. E. Treadon, 2008: A Two Season Impact Study of NOAA Polar Orbiting Satellites in the NCEP Global Data Assimilation System. *Wea. Forecasting*, **23**, 854-877.

Zapotocny, T. H., J. A. Jung, J. F. Le Marshall, and R. E. Treadon 2007a: A Two Season Impact Study of Satellite and In-Situ Data in the NCEP Global Data Assimilation System. *Wea. Forecasting*, **22**, 887-909.

Zapotocny, T. H., J. A. Jung, J. F. Le Marshall, and R. E. Treadon, 2007b: A Two Season Impact Study of four Satellite Data Types and Rawinsonde Data in the NCEP Global Data Assimilation System. *Wea. Forecasting*, **23**, 80-100.

## 30. Assimilation of Hyperspectral Ozone Retrievals and Radiances within GDAS to Improve Lateral Boundary Conditions for NAQFC

**CIMSS Task Leader: Allen Lenzen**

**NOAA Collaborator: R. Bradley Pierce**

**NOAA Long Term Goals**

- Weather-Ready Nation

**NOAA Strategic Goals**

- Serve society's needs for weather and water

**CIMSS Research Themes**

- Satellite Meteorology Research and Applications
- Satellite Sensors and Techniques





- Environmental Models and Data Assimilation

### Proposed Work

The proposed work has two parts. The first is to develop and test the capability to improve the ozone prediction in the GFS through inclusion of a 3 dimensional and diurnally varying ozone production and loss tendencies. The second is to assess the impact of turning off the IASI ozone radiance assimilation in the GDAS analysis system. The first task was “Development and testing of climatological 3D tropospheric ozone P-L in GFS.” This task focused on improving GFS predictions of background tropospheric ozone to facilitate assimilation of ozone retrievals and selected channel radiances within the ozone absorption band (980-1080  $\text{cm}^{-1}$ ). Collaborator Daniel Jacob (Harvard) provided GEOS-Chem 3 hourly ozone production rate (P), loss frequency (L), and surface deposition for July 2011 to test the use of climatological 3D tropospheric ozone P-L within GDAS. Positive or neutral impacts of the updated tropospheric ozone P-L are needed for further development.

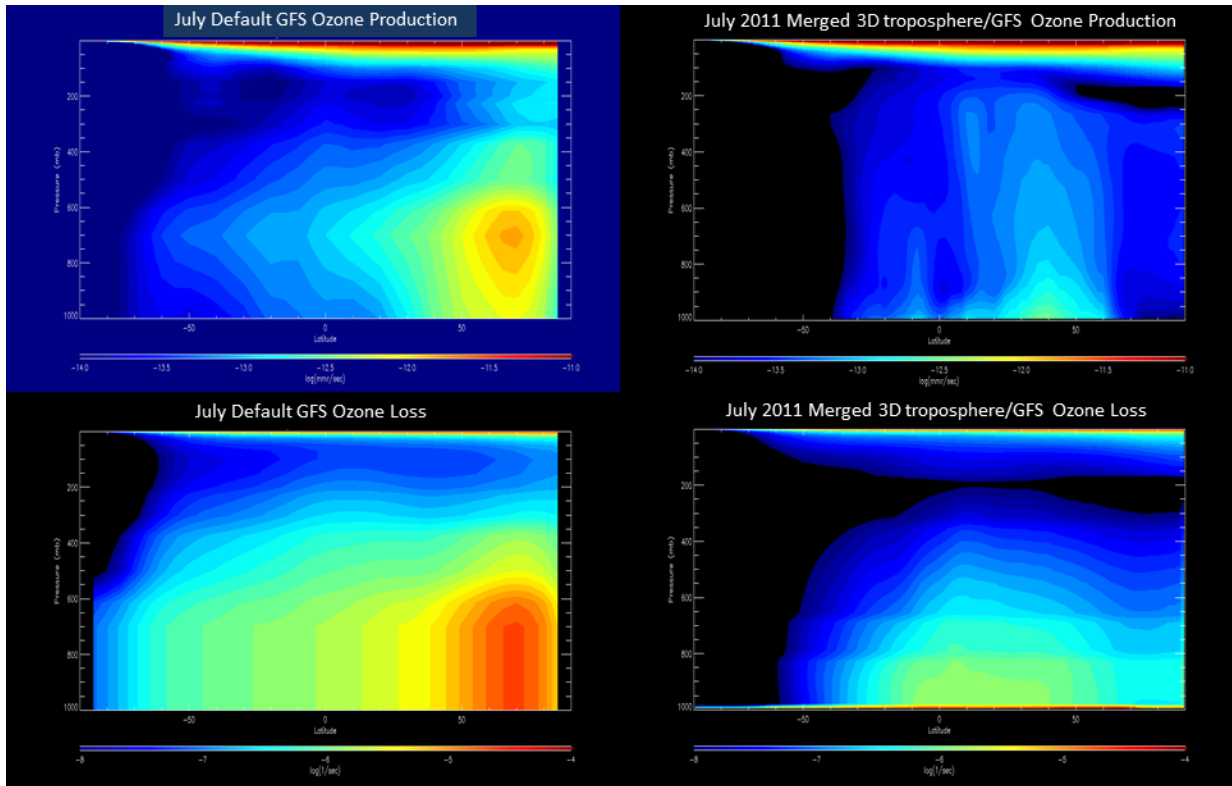
The tasks performed for the development and testing were:

- Operational NCEP GDAS (T574L64, 27 KM) analysis system has been ported to NESDIS/STAR S4 super computer at UW-Madison SSEC and July 2011 GDAS control experiments have been completed (cycling 6hr analysis with 5-day forecasts);
- 3D merged GFS (stratosphere) + GEOS-CHEM (troposphere) ozone PL developed for use in GFS and source code adapted for inclusion of 3D O3 P-L;
- GDAS cycling/forecast experiments using 3D diurnally varying merged GFS/GEOS-CHEM O3 PL were conducted during July 2011; and
- The impact of the updated tropospheric O3 PL has been assessed using the Verification Statistics Data Base (VSDB) from the NCEP Verification System.

### Summary of Accomplishments and Findings

Figure 30.1 shows the distribution of tropospheric ozone production and loss that is currently used within GFS (left panels) and zonally and diurnally averaged July 2011 distributions obtained from the merged 3D ozone production and loss (right panels) developed under this proposal. The merged distributions show much more realistic distributions of tropospheric ozone production (which should maximize near the surface at middle latitudes in the Northern Hemisphere due to anthropogenic emissions of ozone precursors) and loss (which should maximize near the surface in the tropics due to higher water vapor mixing ratios leading to increased OH abundances in faster oxidation).

The impact of the updated tropospheric O3 PL on GFS meteorological forecasts has been assessed using the Verification Statistics Data Base (VSDB) from the NCEP Verification System. Figure 30.2 shows Northern Hemisphere and Southern Hemisphere AC scores for Day 5 500mb height forecasts for the control and 3D O3 PL experiments. Slight improvements are found in the Northern Hemisphere while slight degradations in Day 5 forecasts are found in the Southern Hemisphere. Day 1-5 die-off curves for Northern Hemisphere and Southern Hemisphere 500mb height forecasts show that the differences shown in Figure 30.2 are not statistically significant at the 95% confidence level.



**Figure 30.1.** Comparison of Default July GFS Ozone Production (upper left, expressed in logarithm of mass mixing ratio per second) and Loss (lower left, expressed in logarithm of inverse seconds) with Merged 3D troposphere/GFS ozone Production (upper right) and Loss (lower right).

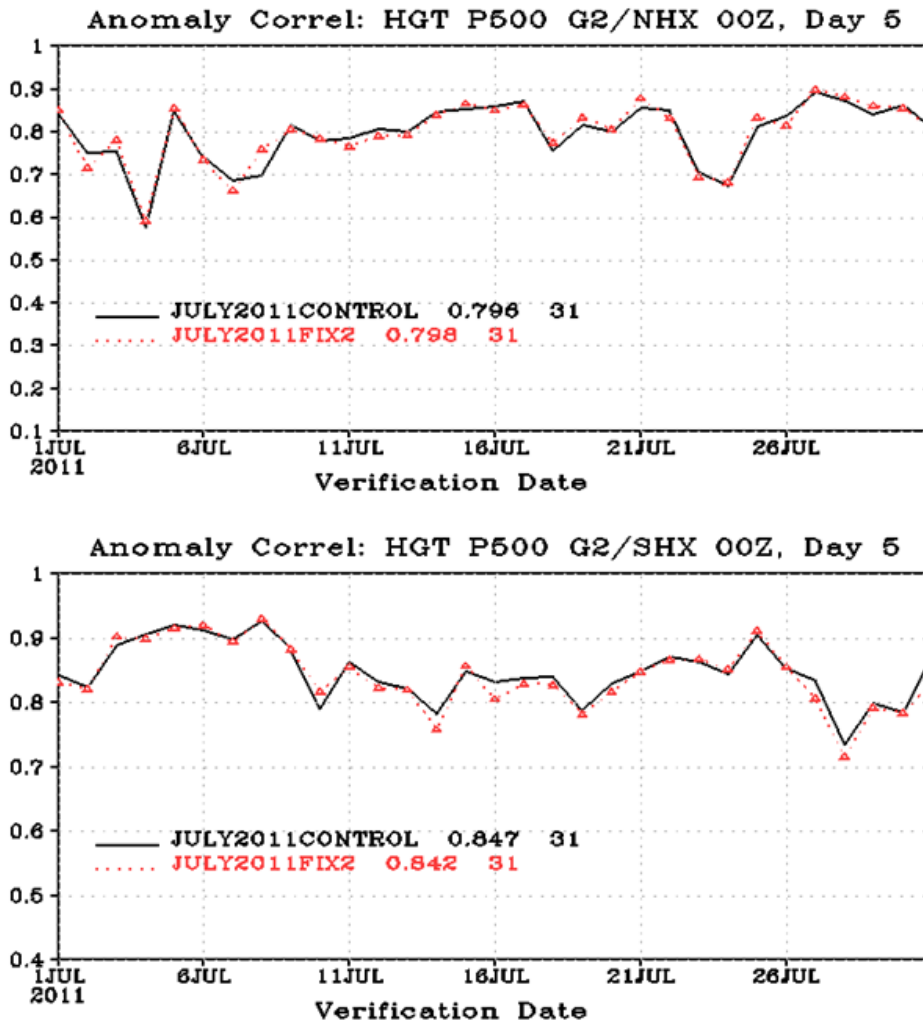
It was found at NCEP that IASI ozone channels had been unintentionally used in operational GSI data assimilation in GDAS system. A data denial experiment was conducted to evaluate the effect of turning off the IASI ozone channels within the GSI for the period mid June 2011 (spin up period) and July 2011.

Turning off the IASI ozone channels has a small mixed result. There was a slight decrease in 500 MB height correlation at day 3 to 4 while the Ozone bias is reduced at the 10 and 20 MB layers and the Ozone correlation is higher at days 3 to 4.

### **Publications and Conference Reports**

Preliminary results from the 3D tropospheric P-L testing was presented at the 3<sup>rd</sup> NASA Air Quality Applied Science Team (AQA) Meeting, June 13-15, 2012 at the University of Wisconsin – Madison.

Presentation at 10<sup>th</sup> JCSDA Workshop on Satellite Data Assimilation at College Park, MD , October 10-12, 2012 “Implementation of GOES Total Column Ozone Assimilation within NAM-CMAQ to improve Operational Air Quality Forecasting capabilities” (R. Bradley Pierce (NOAA/NESDIS/STAR), Todd Schaack, Allen Lenzen (UW-Madison, CIMSS), Pius Lee (NOAA/OAR/ARL))



**Figure 30.2.** Anomaly Correlations (AC) for Day 5 500mb height forecasts from July 2011 GDAS control (black) and 3D O3 PL (red) experiments for the Northern Hemisphere (upper panel) and Southern Hemisphere (lower panel).

### 31. Updating the Secondary Eyewall Formation Probabilistic Model, Completing New Climatologies of Intensity and Structure Changes Associated with Eyewall Replacement Cycles

**CIMSS Task Leader: Christopher M. Rozoff**

**CIMSS Support Scientists: William Lewis (CIMSS/SSEC), Matthew Sitkowski (The Weather Channel)**

**NOAA Collaborator: James P. Kossin**

**NOAA Long Term Goals**

- Weather-Ready Nation
- Resilient Coastal Communities and Economies



## **NOAA Strategic Goals**

- Serve society's needs for weather and water
- Support the nation's commerce with information for safe, efficient and environmentally sound transportation
- Provide critical support for the NOAA mission

## **CIMSS Research Themes**

- Satellite Meteorology Research and Applications
- Satellite Sensors and Techniques
- Environmental Models and Data Assimilation

## **Proposed Work**

The formation of a secondary outer concentric eyewall in a hurricane usually precedes large intensity and wind structure changes. These changes are particularly difficult to forecast because they are not captured well by the standard numerical and statistical guidance. Consequently, when the formation of a secondary eyewall is observed or predicted in an operational setting, forecasters must rely on expert judgment based on past experience to subjectively modify the objective intensity forecasts provided by the available guidance.

In Year-1 of this project, we transitioned a new probabilistic model into NHC operations to help predict the formation of secondary eyewalls (Kossin and Sitkowski 2009). This model has been incorporated into the operational SHIPS intensity forecasting model and has been performing skillfully in an operational setting. In Year-2, we constructed an expanded record of low-level aircraft reconnaissance data and used this to document an expanded climatology of intensity and structure changes associated with eyewall replacement cycles (ERC) in Atlantic hurricanes (Sitkowski et al., 2011). We found that a typical ERC can be naturally divided into three distinct phases. Each phase has associated characteristic changes in intensity and wind structure, and a characteristic duration over which the changes take place. In Year-3, we used the characteristics of these changes to construct new statistical models that use environmental and satellite data to provide objective intensity guidance that specifically targets the changes associated with ERCs (Kossin and Sitkowski 2012). The models are based on ordinary least squares regression and predict the expected intensity changes and the duration over which these changes occur during the most operationally relevant phases of an ERC. The models also provide predictions of expected changes in the radius of maximum tangential wind, which may be useful for wave-height and storm-surge forecasting.

In Year-4 (the final year of this project), we have been working to further increase the skill of the models through optimized feature selection and other techniques, and working toward transitioning the new models developed in Year-3 to operations. Results from Year-4 are described below.

## **Summary of Accomplishments and Findings**

The following results were obtained in the previous year:

- Appended model training/testing dataset with 2011 and 2012 data. The data now span 2008–2012;
- Performed cross-validation (operational) on the Bayesian probability model, the optimized Bayesian probability model, the logistic regression probability model, and a model ensemble (simple average);
  - The Brier Skill Scores are shown in Table 31.1. The models have been performing skillfully in a consistent and robust manner. In 2012, the Brier Skill Scores were quite high because there were so few ERC events and the models



were providing low probabilities of ERCs. Still, it is difficult to claim too much success in 2012 as the one observed ERC event in Hurricane Michael was not forecasted well and was missed. After-the-fact analyses showed that anomalously low MPI and ocean heat content lowered the model probability substantially. Here, the environment that Michael was in when the ERC occurred was highly anomalous with respect to the training data the models are based on, and updating the models with the expanded training data from 2012 is expected to help;

- The Attributes Diagrams are shown in Fig. 31.1. The Bayesian and optimized Bayesian models have performed skillfully at all forecast lead times and have been skillful at providing both low and high probabilities, but the logistic regression model has not been skillful at providing high probabilities at the longest lead time (36-48h); and
- New models to predict intensity and structure changes during an ERC were constructed from the ERC climatologies (described by Sitkowski et al., 2011). The new models are described in Kossin and Sitkowski (2012);
  - The new models have been converted to FORTRAN subroutines and transitioned into SHIPS, but remain disabled for the time being. The utility of these models needs to be discussed further with NHC personnel. The models are expected to provide additional objective guidance preceding and during ERCs that may help forecasters when they are subjectively adjusting the usual numerical and statistical intensity guidance.

### Publications and Conference Reports

Kossin, J., M. Sitkowski, W. Lewis, and C. Rozoff, 2013: A new secondary eyewall formation index; Transition to operations and quantification of associated hurricane intensity and structure changes: A Joint Hurricane Testbed project. *67<sup>th</sup> Interdepartmental Hurricane Conference, College Park, MD.*

Kossin, J. P., and M. Sitkowski, 2012: Predicting hurricane intensity and structure changes associated with eyewall replacement cycles. *Wea. Forecasting*, **27**, 484-488.

Sitkowski, M., J. P. Kossin, C. M. Rozoff, and J. Knaff, 2012: Hurricane eyewall replacement cycles and the relict inner eyewall circulation. *Mon. Wea. Rev.*, **140**, 4035-4045.

Sitkowski, M., J. P. Kossin, and C. M. Rozoff, 2011: Intensity and structure changes during hurricane eyewall replacement cycles. *Mon. Wea. Rev.*, **139**, 3829-3847.

### References

Kossin, J. P., and M. Sitkowski, 2009: An objective model for identifying secondary eyewall formation in hurricanes. *Mon. Wea. Rev.*, **137**, 876–892.



**Table 31.1.** Brier skill scores from operational testing on the years 2008-2012 for the Bayesian probability model, the optimized Bayesian probability model, the logistic regression probability model, and a model ensemble (simple average) for all model lead times.

**Operational Model Verification 2008-2012 (Brier Skill Scores)**

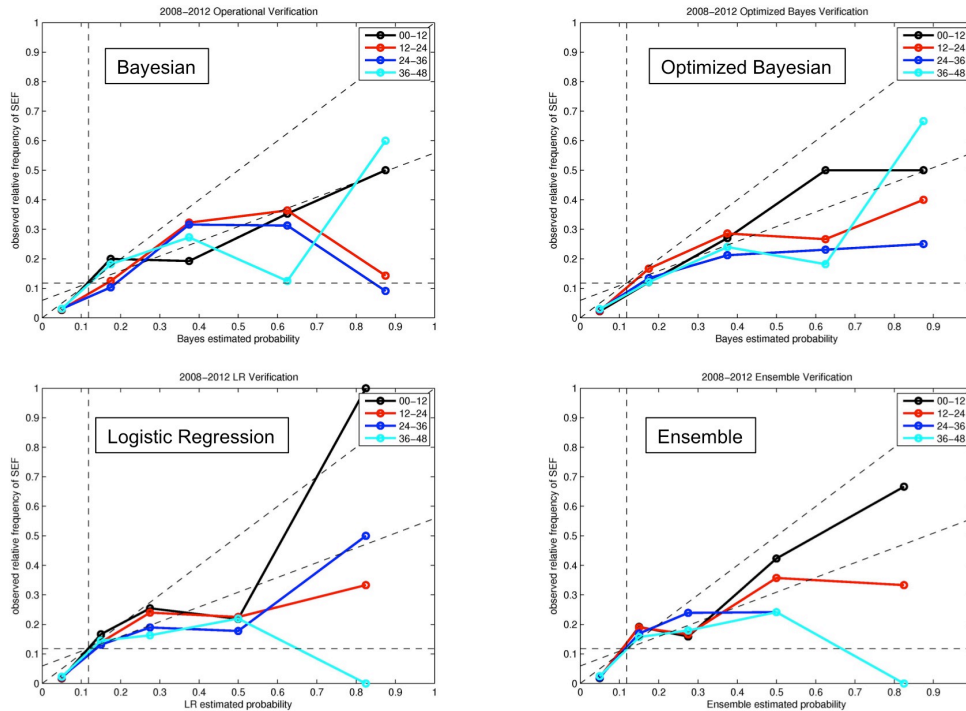
Year	N (TS)	N (HUR)	N (ERC)	00-12 hr	12-24 hr	24-36 hr	36-48 hr
2012	19	10	1	+57	+58	+58	+57
				+54	+53	+54	+54
				+54	+51	+42	+35
				+56	+54	+52	+49
2011	18	6	5	+21	+18	+14	+19
				+22	+16	+13	+16
				+10	+11	+6	+11
				+20	+17	+14	+18
2010	19	11	9	+27	+23	+11	+10
				+41	+20	+17	+17
				+25	+25	+15	+8
				+38	+28	+20	+17
2009	9	3	3	-6	-2	-1	+5
				-6	-8	-6	+6
				+11	+6	+28	+36
				+7	+3	+17	+27
2008	16	8	4	+14	+12	-5	+2
				+11	+4	-7	-6
				+2	-7	+0	-4
				+10	+4	+0	+0
2008-2012	81	38	22	+20	+17	+9	+11
				+26	+16	+13	+15
				+22	+18	+15	+12
				+27	+21	+17	+17

Bayesian     
 Optimized Bayesian     
 Logistic Regression     
 Ensemble





## Operational model verification 2008-2012 (attributes diagrams)



J. Kossin, 67th IHC, Mar 2013

Figure 31.1. Attributes diagrams for the models.

## 32. Real Time Prediction of Hurricanes and Investigation of Factors Influencing Numerical Intensity Prediction

**CIMSS Task Leader: Gregory Tripoli**

**CIMSS Support Scientist: William Lewis**

**NOAA Long Term Goals**

- Weather-Ready Nation

**NOAA Strategic Goals**

- Serve society's needs for weather and water
- Support the nation's commerce with information for safe, efficient and environmentally sound transportation

**CIMSS Research Themes**

- Satellite Meteorology Research and Applications
- Environmental Models and Data Assimilation

This project consisted of two primary components, including: (1) real time model forecasts of Atlantic hurricanes, using the UW-NMS model, for the Hurricane Forecast Improvement Project (HFIP) conducted by NOAA over the 2012 hurricane season and (2) develop improved modeling techniques that improve intensity forecasting to be tested in real time in future years. Below we discuss results of these two components



### **Proposed Work: Real-time Prediction of Hurricanes**

As part of NOAA's HFIP (Hurricane Forecast Improvement Project) 2012 demonstration system (1 August to 31 October, 2012), our group completed in excess of 330 forecasts for Atlantic basin tropical cyclones and the data were transmitted to the Developmental Testbed Center (DTC) and the National Hurricane Center (NHC) in near real time in addition to being made available to the public on the World Wide Web at:

<http://cup.aos.wisc.edu/will/HFIP/>.

### **Summary of Accomplishments and Findings: Real-time Prediction of Hurricanes**

The results for these forecasts are shown in figures 32.1 and 32.2 below. A homogeneous comparison with the other regional dynamical models demonstrates that our model (UWN8) outperformed all others with regard to track and was a very close second to the Geophysical Fluid Dynamics Laboratory (GFDL) model for intensity.

Currently we are preparing for the 2013 demonstration and have completed the following in fulfillment of this goal:

- Retrospective forecasts for all Atlantic and Eastern Pacific basin tropical cyclones occurring between 1 August and 31 October for the previous three seasons (2010-2012) using both deterministic and ensemble approaches (in excess of 1,000 deterministic and 6,000 ensemble forecasts); and
- The diagnostic output module developed by Mark DeMaria et al. at the Cooperative Institute for Research in the Atmosphere (CIRA) has been tested and incorporated into our workflow, allowing a broader comparison between our forecast results and those of other groups.

Yet to be completed goals for the remainder of this year include:

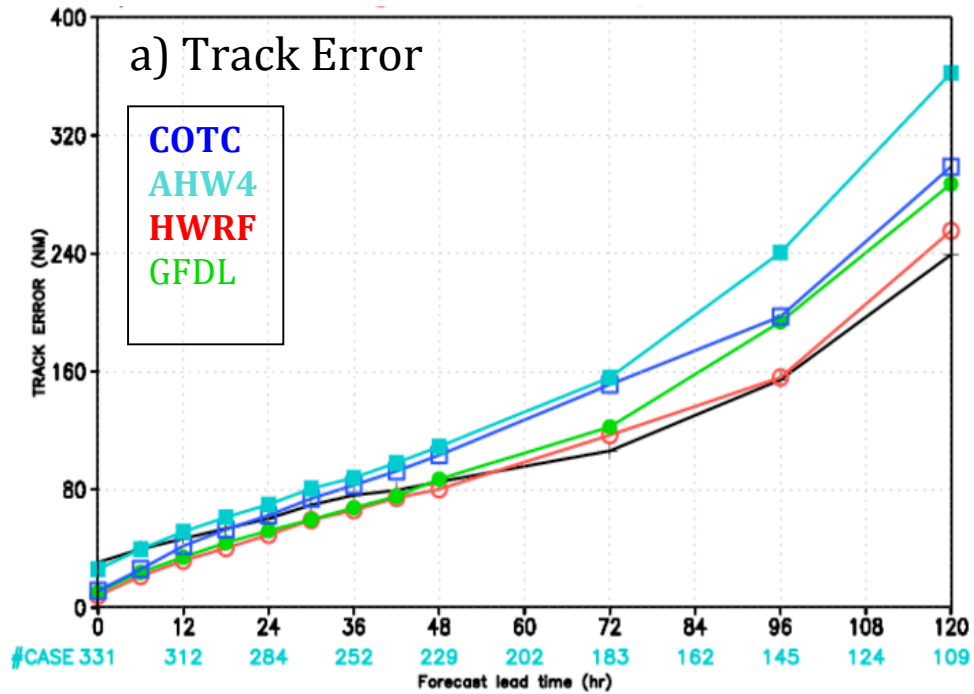
- Upgrades to the project Web site (referenced above), to include improved animation capability and enhanced ease of use; and
- Developing appropriate infrastructure for ensemble data assimilation within the NOAA jet computing environment, to eventually include satellite data assimilation for forecast initiation.

### **Proposed Work: Model Improvement Studies**

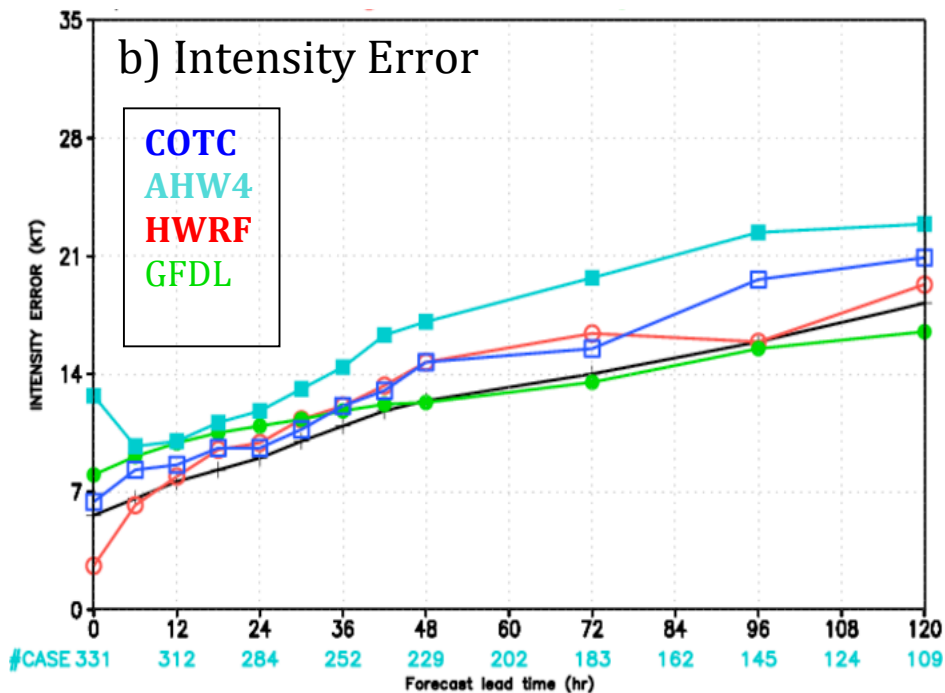
These studies were focused in three areas:

1. Improving the simulation of turbulence, particularly in the PBL;
2. Improving the interaction with outer nests, e.g., the GFS, which provides initial and boundary conditions for NMS forecasts; and
3. Understanding of environmental interactions that cause intensity change and how these interactions can be better represented.





**Figure 32.1.** Mean absolute track forecast error for NOAA HFIP regional dynamical models. (COTC=COAMPS TC, AHW4=Advanced Hurricane WRF, HWRF=Hurricane WRF, GFDL=Geophysical Dynamics Laboratory, UWN8=University of Wisconsin)



**Figure 32.2.** Mean absolute intensity error for NOAA HFIP regional dynamical models. (COTC=COAMPS TC, AHW4=Advanced Hurricane WRF, HWRF=Hurricane WRF, GFDL=Geophysical Dynamics Laboratory, UWN8=University of Wisconsin)



Some comments on our progress are presented below.

- *Turbulence Simulation*  
We have performed several idealized and real storm simulations at large eddy-resolving resolution to better understand how the representations of turbulence processes are affecting tropical cyclone prediction. We are preparing a series of 2 papers on this study and a student is preparing a Masters thesis also based on this study. The key results are that there is a strong coupling between the surface friction layer and the eye wall structure. Coherent structures in the surface layer extend into the eye wall and affect the thermal and dynamic structures there. The mixing process on the inner and outer eye wall are important to the dilution of the high entropy layers lifted from the surface, and so impact the eventual entropy of the outflow and so nature of the outflow environmental interaction. This interaction is driven in large part by the relationship between the storm outflow potential vorticity and that of the environment. This part of the study will be formed into a third paper describing the relationship between turbulence, surface fluxes and environmental interaction.
- *Interaction with Outer Nests*  
A number of studies have shown that the global models tend to do better on storm track position. This is most likely because there are no artificial boundary conditions affecting storm behavior. We have developed a technique that gives increased weight to the GFS track position while preserving the NMS models ability to better capture intensity change with cloud resolving resolution. Results have been quite promising. These improvements have been incorporated into our real-time production.
- *Environmental Interactions.*  
We have studied how the outflow environment feeds back on storm development. This was done with an energy budget that isolates the amount of energy being spent on outflow related work. Results confirm our hypothesis that the potential vorticity environment of the outflow is a key factor in development. Moreover, we have shown that the outflow resistance can vary diurnally as a result of radiative processes making intensity variability diurnally modulated, particularly during genesis when the outflow resistance is more critical to intensity growth. We are planning 1-2 papers covering: (1) the energetics study and (2) the outflow resistance study over the next year.

These studies are ongoing, and our primary focus for the remaining period of this project and into the next year has shifted to paper preparation.

### **Summary of Accomplishments and Findings: Model Improvement Studies**

This project has resulted in an exceptionally successful implementation of the UW-NMS in a real time environment. As a completely different model, compared to the other regional hurricane prediction models, it provides a valuable alternative prediction to those made by other modeling approaches of the WRF, GFDL and ONR models. Moreover, the NMS predictions have been surprisingly accurate, when compared to all of the other available products, including those involving extensive assimilation procedures. We believe this is due to the NMS approach to a conservative dynamics core prediction and the better incorporation of the parent global model track prediction into the regional prediction.

The research based studies have already to a much improved dynamics core utilizing an important energy budget which appears to tether the prediction to reality compared to models which have no strict energy budget. Our research is revealing the importance of this budget and overall, will result in fresh ideas leading to the improvement of all models.



### **33. CIMSS Cal/Val Activities in Support of the Calibration Working Group**

**CIMSS Task Leader: Mathew M. Gunshor**

**CIMSS Support Scientists: James P. Nelson III, Anthony J. Schreiner**

**NOAA Collaborator: Timothy J. Schmit**

#### **NOAA Long Term Goals**

- Weather-Ready Nation

#### **NOAA Strategic Goals**

- Serve society's needs for weather and water
- Provide critical support for the NOAA mission

#### **CIMSS Research Themes**

- Satellite Meteorology Research and Applications
- Satellite Sensors and Techniques

#### **Proposed Work**

CIMSS has been heavily involved in GOES calibration as well as product generation since its inception. The experience developed at CIMSS on current GOES has been extended to include the GOES-R ABI. Over half of the ABI product algorithms were developed at CIMSS.

There are three objectives to this project. The first is to assist the GOES-R Calibration Working Group (CWG) on matters of ABI calibration by consulting (through the monthly CWG telecons) with the group and, when appropriate, offering a tie-in to products to help quantify and understand calibration issues. This will help ensure ABI L1b calibration and data quality. The capability of generating products, comparing product outputs, and product analysis has been developed at CIMSS already under the AWG. The second objective is to assist the CWG with Japan Meteorological Agency (JMA)'s Advanced Himawari Imager (AHI) in understanding the calibration and navigation, which allows us to leverage any knowledge gained at JMA and will help the CWG prepare for the ABI. The AHI is very similar to ABI and is being constructed by the same company. In addition to this we propose to continue the monitoring of current GOES Sounder calibration using the "calc versus obs" method begun in the prior year, in preparation for the GOES-R ABI.

#### **Proposed Tasks**

1. Attend monthly CWG telecons.
2. Assist CWG in analysis of calibration issues as pertaining to their effects on products, supporting L1b calibration and ensuring ABI data quality.
3. Assist CWG in analysis of calibration and navigation on JMA's AHI.
4. Continue GOES Sounder "calc versus obs" monitoring.

#### **Summary of Accomplishments and Findings**

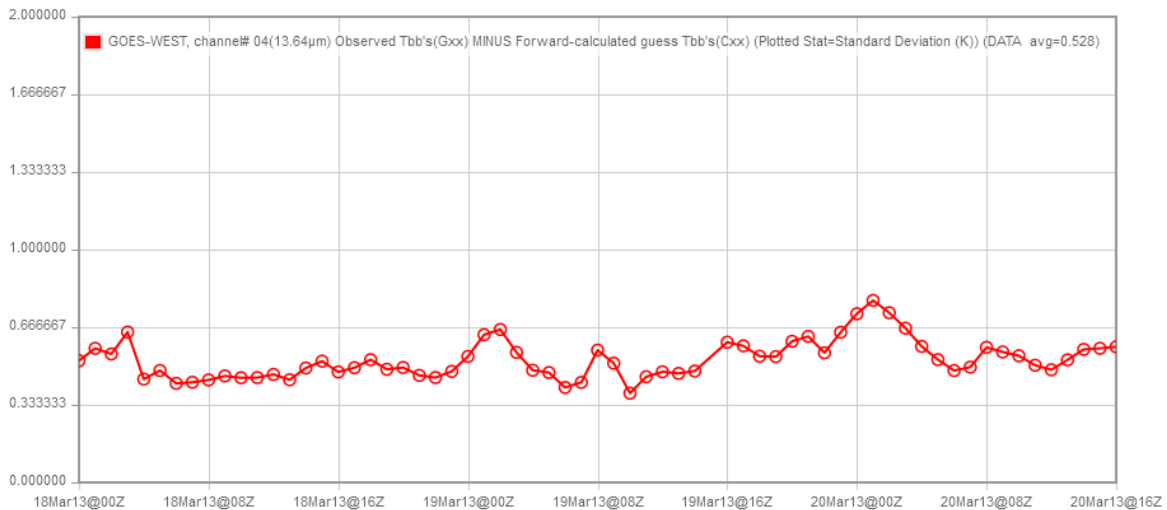
CIMSS has had a representative at Calibration Working Group (CWG) monthly meetings (teleconferences). There have been presentations from CIMSS at these meetings to show how CIMSS scientists address issues with current GOES. While the CWG is focused on GOES-R, there is overlap in personnel between current and future GOES calibration teams and projects. While the issues affecting current GOES may not be the same for future GOES, the methods and techniques developed now can either be applied later for GOES-R or can provide guidance on how to handle future situations. One of the topics discussed by CIMSS was an issue of co-registration affecting the GOES-13 Imager. Co-registration is a problem where data from two or more satellite bands from the same instrument are not aligned properly on the Earth coordinate



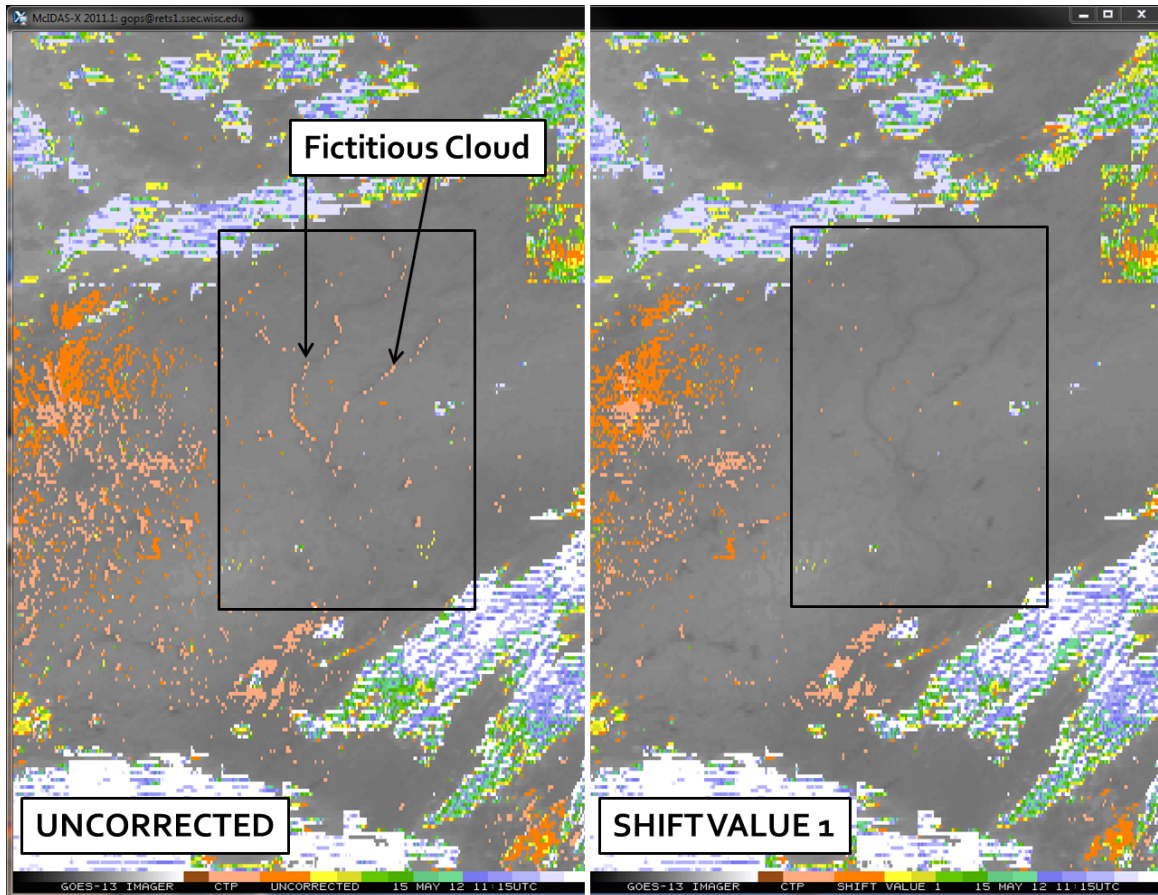
system. Slides were presented illustrating the process of how the issue was discovered (fictitious fog and clouds in river valleys and along other land/water boundaries) and highlighting the effect of the co-registration problem on products such as cloud top pressure and the cloud mask.

In addition to this, CIMSS continues to maintain a Web page for monitoring GOES Sounder calibration. The method utilized for this is primarily comparing calculations from a forward model using forecast model atmospheric profile data to actual Sounder observations. This is often referred to as “calc vs. obs,” and is used by EUMETSAT and others as well. The GOES Sounder monitoring Web site has gone through many upgrades, and is now capable of generating custom plots and saving the plots to the user’s local computer. This is an improvement over previous versions of the page which had static plots generated automatically. Allowing the user to generate their own plots provides the ability to choose custom dates and overlay multiple variables on one plot.

At this time, JMA is still working on AHI and they do not have any data to share. Several members of NOAA/NESDIS/ASPB have visited JMA to discuss AHI and so collaborations are under way.



**Figure 33.1.** This plot is from the CIMSS GOES Sounder Calc vs. Obs monitoring Web site and shows the difference between observed brightness temperatures and forward-calculated (from GFS model data) brightness temperatures for band 4 (13.64 micrometer) for the GOES-15 Sounder. The Sounder patch temperature was “floating” and the effects could be seen around 2-3UTC on these days. [http://cimss.ssec.wisc.edu/goes/sounder\\_tbb\\_stats/tbbc.html](http://cimss.ssec.wisc.edu/goes/sounder_tbb_stats/tbbc.html)



**Figure 33.2.** The effects of a co-registration error are seen in this GOES-13 Imager cloud top pressure comparison from 11:15UTC 15May2012. Co-registration is a problem where data from two or more satellite bands from the same instrument are not aligned properly on the Earth coordinate system. Since cloud products, among others, rely on band differencing, this creates a problem. On the left, the uncorrected data show fictitious cloud along several river borders (e.g., Mississippi and Illinois Rivers) as well as along some small lakes. On the right is the cloud top pressure product after the data have been corrected; note that the fictitious clouds along rivers and lakes have been removed.

#### 34. CIMSS Support of STAR Calibration/Validation Activities for 2012

**CIMSS Task Leaders: Mathew M. Gunshor, Christine Molling**

**CIMSS Support Scientists: Scott Lindstrom, Sharon Nebuda**

**NOAA Collaborators: Timothy J. Schmit, Andrew Heidinger**

##### **NOAA Long Term Goals**

- Weather-Ready Nation

##### **NOAA Strategic Goals**

- Serve society's needs for weather and water
- Support the nation's commerce with information for safe, efficient and environmentally sound transportation
- Provide critical support for the NOAA mission



## **CIMSS Research Themes**

- Satellite Meteorology Research and Applications
- Satellite Sensors and Techniques

## **Proposed Work**

NOAA participates in research promoting and advancing the knowledge of intercalibration techniques through the Global Space-Based Inter-Calibration System (GSICS). The primary goal of GSICS is to improve the use of space-based global observations for weather, climate and environmental applications through operational inter-calibration of the space component of the WMO Global Observing System (GOS) and Global Earth Observing System of Systems (GEOSS). GSICS methodology was built in collaboration with input from CIMSS researchers and CIMSS has supported the GSICS effort throughout the development phase. This proposal supports NOAA's efforts with GSICS and also the NOAA Mission Goals of Climate and Weather and Water.

The first task of this proposal outlines a plan to perform retrospective analysis using the GSICS method. This effort builds on work done in the previous year to do similar tasks. The operational GSICS team performs intercalibration daily for their host of geostationary imagers and includes the United States, Japan, China, and Europe. CIMSS scientists will conduct a retrospective analysis of all of the instruments being done operationally, as well as several instruments no longer in operations. It was proposed to use AIRS to intercalibrate the GOES, Meteosat, FY-2, and MTSAT Imagers using the NESDIS GSICS algorithm retrospectively for the entire period of data record overlap between AIRS and these geostationary imagers. When that is completed, the same would be done for the GOES Sounders. The GSICS code will be provided to CIMSS by NOAA-NESDIS-STAR. CIMSS will implement the code locally and leverage other projects to obtain the AIRS data. The Space Science and Engineering Center (SSEC) Data Center has the geostationary data archive available for CIMSS scientists at a small cost to individual projects. The previous year's task was to perform this retrospective processing for the GOES imagers.

In addition to this retrospective processing, a second task for this proposal was the development of the sun-glint based visible calibration, a project led by Andrew Heidinger. Sun-glint is apparent in both the 0.65 and the 3.9 micrometer channels on almost all satellite imagers including all geostationary imagers. This work builds on past work using other channels to inter-calibrate satellite radiances. The benefit of this work is the calibration information is available in real-time and is ideal for monitoring the calibration of the global geostationary satellites. This method is also applicable to historical satellite imagers that flew before the current suite of sensors with on-board calibration. This work will be completed in the last half of 2013.

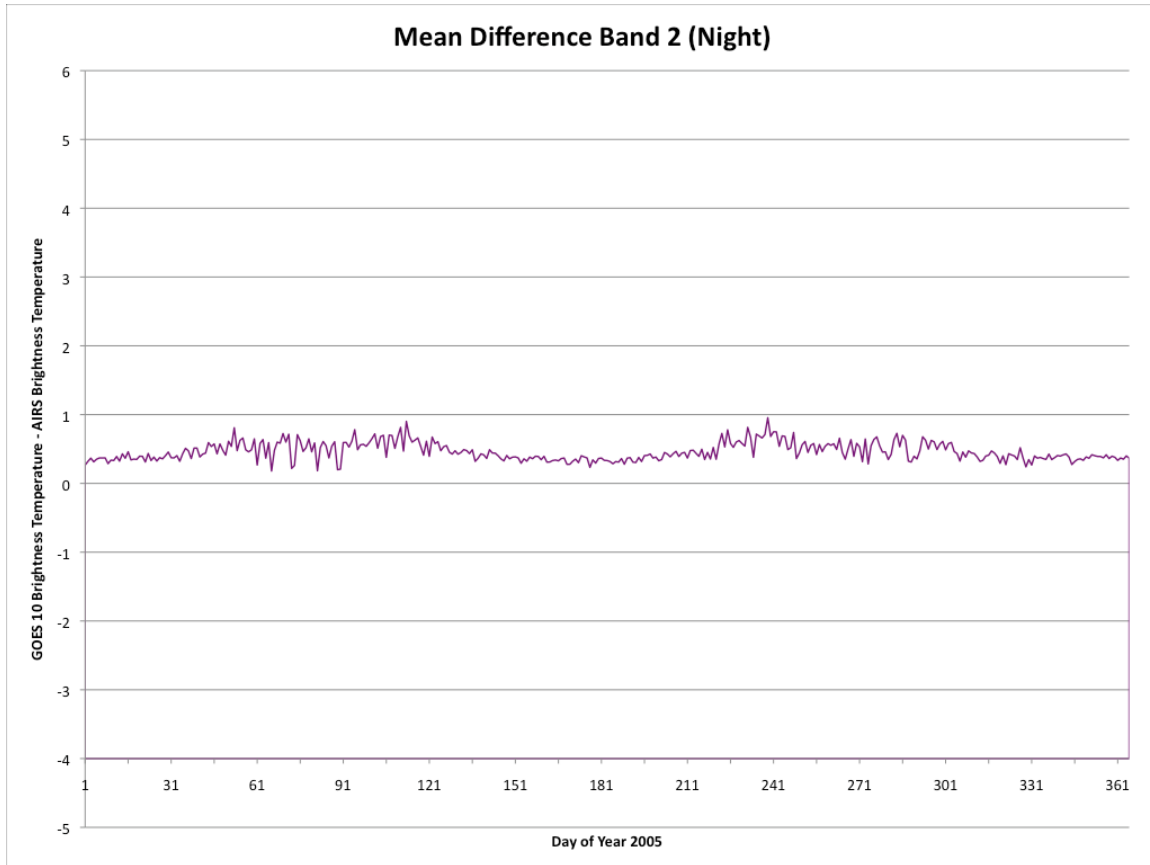
## **Summary of Accomplishments and Findings**

Task 1: The generation of GSICS output is running smoothly. All of the data for the GOES Imagers has been delivered to NESDIS. Comparisons with METEOSAT-9 and METEOSAT-7 have been completed and delivered to NESDIS as well. Comparisons continue with METEOSAT-8. In June of 2008 EUMETSAT made changes to their data regarding the definition of radiance. This has caused some confusion here at SSEC as to what data are in the archive and how much of a difference the change has caused in GSICS results. While the questions of the archive's contents have been answered, the answer to how much of an effect remains open.

Working in conjunction with scientists at STAR on prioritizing the order in which the data are produced, all of the GSICS data have been processed and delivered for GOES/AIRS overlap dates. For GOES-08, 148 days during 2002-2003; for GOES-09 854 days during 2003-2005; for



GOES-10 2,366 days during 2002-2009; for GOES-11, 1,976 days during 2006-2001; and for GOES-12, 3,138 days during 2003-2010. Some of the data for METEOSAT have been delivered: for MET-07, 1,035 days during 2007-2009 and for MET-09, 1,644 days during 2007-2011. The date ranges listed are not always continuous as satellites go in and out of operational mode and/or are moved.



**Figure 34.1.** GSICS Intercalibration results for band 2 (3.9 micrometer) of the GOES-10 Imager compared to AIRS; GOES is slightly warmer than AIRS by approximately 0.5 K. Only nighttime results are shown since reflected solar radiation during the day creates difficulties for comparisons in this shortwave band. The results shown are just for the year 2005.

Task 2:

- The Pathfinder Atmospheres Extended (PATMOS-x) processing system was modified to generate atmospherically corrected 0.65 and 3.9  $\mu\text{m}$  reflectances. These are the basis of the calibration.
- Technique was demonstrated on MODIS data which have a known accurate and stable calibration.
- MODIS results compared to theoretical calculations using the Fresnel reflectance equations for salt water.

**Publications and Conference Reports**

Zhang, Yong and Gunshor, Mathew M. Intercalibration of FY-2C/D/E infrared channels using AIRS. *IEEE Transactions on Geoscience and Remote Sensing*, **51**, Issue 3, 2013, pp.1231-1244.



Both tasks were briefed by Andrew Heidinger at a meeting of the GSICS Research Working Group.

## References

Goldberg, Mitch; Weng, F.; Wu, X.; Yu, F.; Wang, L.; Tobin, D. C. and Gunshor, M. M.. The Global Space-based InterCalibration System (GSICS) for GOES-R and JPSS. Annual Symposium on Future Operational Environmental Satellite Systems, 7th, Seattle, WA, 23-27 January 2011. American Meteorological Society (AMS), Boston, MA, 2011.

Gunshor, Mathew M.; Schmit, Timothy J.; Menzel, W. Paul, and Tobin, David C., 2009: Intercalibration of broadband geostationary imagers using AIRS. *Journal of Atmospheric and Oceanic Technology*, **26**, no.4, pp746-758.

Zhang, Yong and Gunshor, Mathew M., 2013 Intercalibration of FY-2C/D/E infrared channels using AIRS. *IEEE Transactions on Geoscience and Remote Sensing*, **51**, Issue 3, pp.1231-1244.

## 35. Support for NOAA Cloud Climate Data Records

**CIMSS Task Leader: Michael J. Foster**

**NOAA Collaborator: Andrew Heidinger**

### NOAA Long Term Goals

- Climate Adaptation and Mitigation

### NOAA Strategic Goals

- Serve society's needs for weather and water
- Understand climate variability and change to enhance society's ability to plan and respond
- Provide critical support for the NOAA mission

### CIMSS Research Themes

- Satellite Meteorology Research and Applications
- Satellite Sensors and Techniques

## Proposed Work

The Pathfinder Atmospheres Extended (PATMOS-x) is a NOAA/NESDIS climate dataset generated in partnership with CIMSS. Until recently, PATMOS-x dealt exclusively with data from the Advanced Very High Resolution Radiometer (AVHRR) with instruments on the POES and METOP series of polar orbiting spacecraft. PATMOS-x has been modified to generate products from MODIS, GOES and the VIIRS sensor.

In 2010, PATMOS-x was selected as one of the first three Climate Data Records (CDR) to become operational CDRs at the National Climatic Data Center (NCDC). The version of PATMOS-x chosen for this delivery was the AVHRR-only version. NCDC's main goal was to host the PATMOS-x solar reflectance sensor data records (SDRs), which included the 0.63, 0.86 and 1.63  $\mu\text{m}$  reflectances.

## Summary of Accomplishments and Findings

During this reporting year, the milestones necessary to maintain and augment the PATMOS-x operational CDRs at NCDC are as follows:

- Incorporate additional quality assurance tools,
- Provide support to NCDC for proper usage of the CDR in operations,



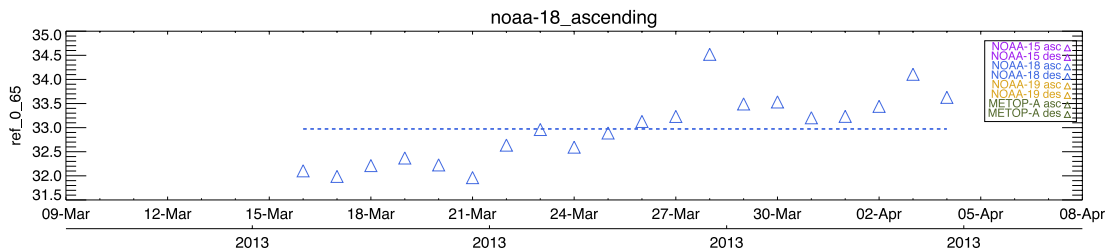


- Implement a system to process and deliver daily updates to the CDR record, and
- Report PATMOS-x usage statistics.

The primary milestone of this year entails shifting from bulk delivery of PATMOS-x calibrated reflectance CDRs to real-time updates with daily deliveries. Efforts have focused on scripting the automated daily delivery of precursor and ancillary datasets as well as the processing of the PATMOS-x CDR through the Clouds from AVHRR Extended (CLAVRX) framework and subsequent delivery to the NCDC archives. To this end the automated generation of these files has been accomplished. The list of parameters to include and formatting considerations are currently being addressed, and once these details have been ironed out daily deliveries will commence.

Towards the goal of incorporating additional quality assurance tools global mean values of the visible reflectance channels were added as global attributes in the PATMOS-x file metadata. Automated plotting of these metrics for the last 30-days has been implemented allowing for simple and quick monitoring of the most recent additions to the CDR record. Figure 35.1 shows an example of one such plot.

The other milestones set for this period are providing support for the NCDC team for the proper usage of the CDR in operations and collecting usage statistics of PATMOS-x. These are ongoing services that we have maintained throughout this year.



**Figure 35.1.** Example of a PATMOS-x CDR monitoring figure for channel 1 on the NOAA-18 AVHRR. Values are taken from the CDR file metadata. The dashed line represents the mean reflectance over the period being monitored.

### Publications and Conference Reports

Heidinger, A. K., M. J Foster, A. Walther and X. Zhao, 2013: The Pathfinder Atmospheres Extended (PATMOS-x) AVHRR Climate Data Set. Submitted to *Bull. Amer. Meteor. Soc.*

### References

Heidinger, Andrew K.; Straka, William C. III; Molling, Christine C.; Sullivan, Jerry T. and Wu, Xiangqian. Deriving an inter-sensor consistent calibration for the AVHRR solar reflectance data record. *International Journal of Remote Sensing*, **31**, Issue 24, 2010, pp.6493-6517.



## 36. Reprocessing HIRS

**CIMSS Task Leader: Paul Menzel**

**CIMSS Supporting Scientists: Erik Olson, Richard Frey, Eva Borbas**

**NOAA Collaborator: Jeff Privette, Changyong Cao**

### **NOAA Mission Goals**

- Climate Adaptation and Mitigation
- Weather-Ready Nation

### **NOAA Strategic Plan-Mission Goals**

- Serve society's needs for weather and water
- Understand climate variability and change to enhance society's ability to plan and respond
- Provide critical support for the NOAA mission

### **CIMSS Research Themes**

- Satellite Meteorology Research and Applications
- Satellite Sensors and Techniques

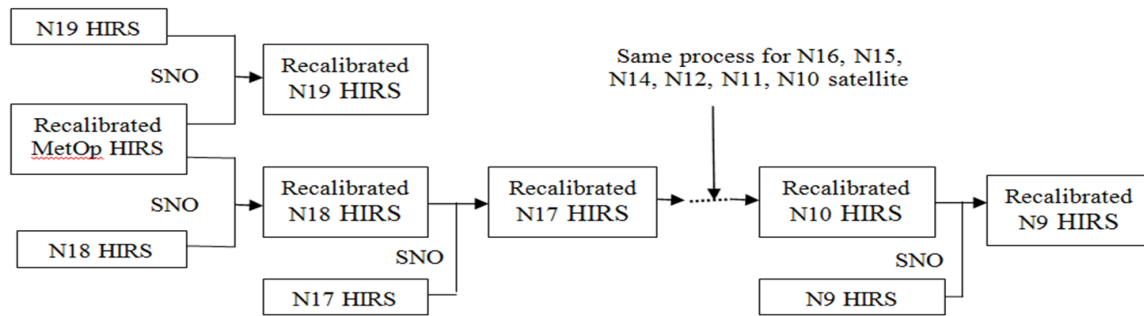
### **Proposed Work**

The SNO and AIRS-IASI recalibrated HIRS radiance measurements will be reprocessed using algorithms for cloud top properties (cloud amount, cloud top pressure, and associated error structures) and clear sky water vapor products (total precipitable water, TPW, and upper tropospheric humidity, UTH) that have been advanced in recent studies with the MODIS (Moderate resolution Imaging Spectroradiometer). Results from SNO recalibration will be compared with AIRS-IASI recalibration where possible. It has been found that relatively small changes in the HIRS radiances can translate into large differences in the cloud and water vapor products. The product consistency during transition periods from one sensor to another will be used as a measure of the recalibration. The resulting radiance climatology of clear and cloudy atmospheric conditions catalogued against the retrieved cloud and water vapor products will enable interpretation of the accuracy of observed trends in radiance in terms of geophysical variables. This provides the needed traceability to international standards (SI).

### **Summary of Accomplishments and Findings**

#### ***Mitigating Sensor to Sensor Differences***

Sensor to sensor calibration differences continue to be studied in collaboration with the STAR calibration team. The approach is to estimate radiance changes for a specific channel due to Spectral Response Function (SRF) modifications and related uncertainty. A linear model correlates the radiance change in a selected channel with the spectral radiances in selected HIRS channels. The hyper-spectral measurements from the Infrared Atmospheric Sounding Interferometer (IASI) on the MetOp satellite are used to simulate HIRS observations and to estimate the parameters in the linear models. The linear models are applied to the NOAA and MetOp HIRS data at Simultaneous Nadir Overpass (SNO) locations to estimate the inter-satellite radiance differences. The inter-satellite mean radiance biases are minimized with residual maximum uncertainty less than 1% after the impacts of SRF differences and uncertainties are taken out. With use of the MetOp HIRS as a reference, the optimized SRFs for every NOAA HIRS are found by minimizing the root-mean-square values of inter-satellite radiance difference.

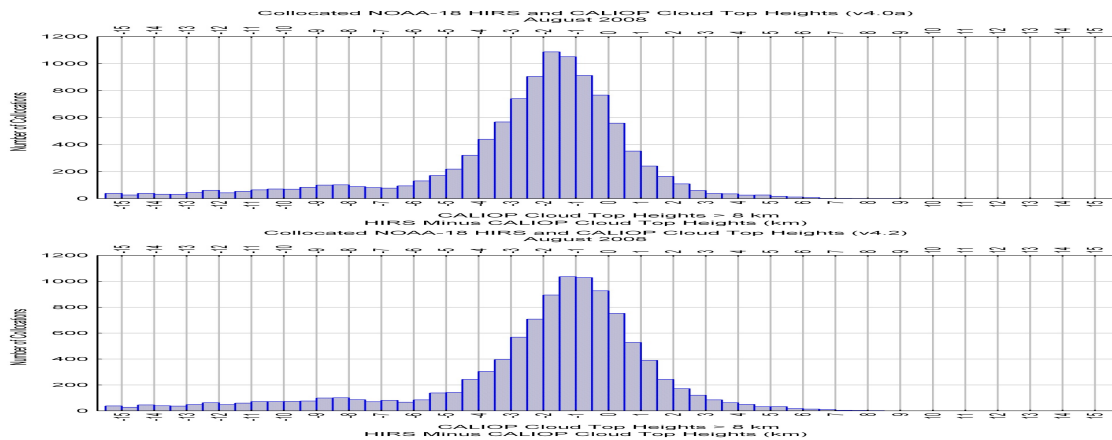


**Figure 36.1.** Schematic of the recalibration process using Metop IASI and SNOs.

After another re-calibration wherein the H<sub>2</sub>O channel shifts were finalized, the optimized shifts of the SRF are found to be as large as 2.8 cm<sup>-1</sup> for the CO<sub>2</sub> channels and 7.1 cm<sup>-1</sup> for the H<sub>2</sub>O channels. In some cases large differences in the SNO recalibration from the south pole were found with respect to those from the north pole; these are still being investigated especially for NOAA-11 channel 5. Note that each time a SRF is changed, several years of data need to be processed again to assess the results from the SRF change. That is, the ability to assess changes that result from simple SRF modifications relies on a significant amount of data reduction.

### Comparison with CALIOP

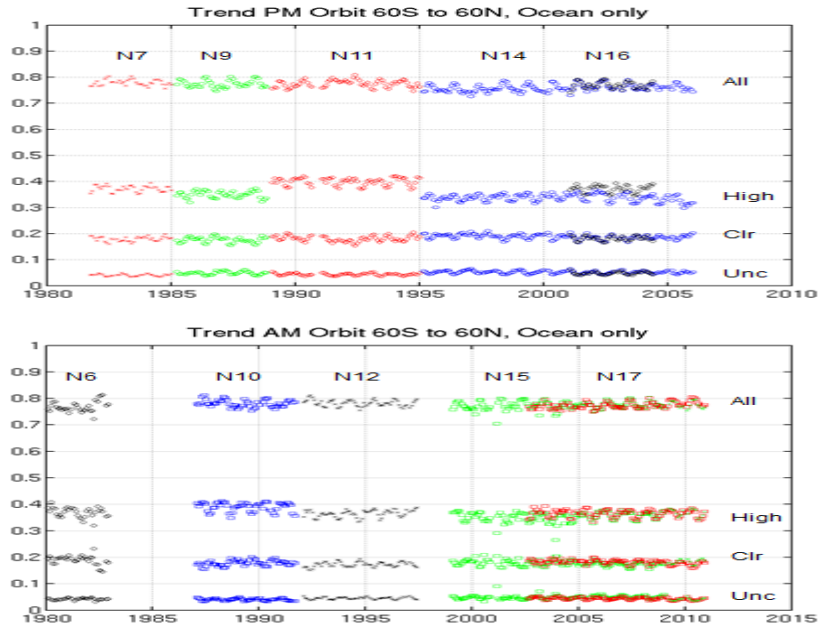
Effects of the recalibration on cloud top heights were studied using CALIOP as a reference. High cloud determinations from NOAA-18 shifted to a better comparison with CALIOP determinations for August 2008 (see Figure 36.2).



**Figure 36.2.** HIRS minus CALIOP high cloud heights for NOAA-18 without (top) and with (bottom) SRF shifts in August 2008.

### Reprocessing the HIRS Cloud Dataset

HIRS data from NOAA-6 onwards have been re-processed using the original HIRS algorithm software with adjustments suggested by MODIS experience and spectral shifts suggested using Metop HIRS as a reference. Figure 36.3 shows the resulting afternoon and morning high cloud trends over ocean. Sensor to sensor differences in the high cloud products are found to have been largely mitigated, except for NOAA-11 where large differences in the North and South Pole SNO recalibrations were noted for channel 5. Further study into NOAA-11 (and possibly NOAA-16) is planned.



**Figure 36.3.** Afternoon and morning high (CTP<440 hPa) cloud over ocean trends from 1980 through 2009 given in fraction of total HIRS observations after the spectral shifts.

### **Recoding the HIRS Cloud and TPW Algorithms**

SSEC/CIMSS is developing software for converting HIRS Level 1b and higher level data files to netCDF-4. The flat file (i.e., Level 1b) to netCDF4 converter has been developed and now is being tested with scientists to assure that the output files are well organized. Transfer to NCDC is planned for Dec 2012.

The MODIS cloud algorithm software adaptation to HIRS continues. Past progress has included (1) using HIRS HDF-4 radiance and geo-location input data files with MODIS-like Collection 6 algorithms for clouds and moisture, (2) incorporating collocated AVHRR cloud mask data from PATMOS-X into the HIRS reprocessing to provide a sub-HIRS-pixel cloud mask - a HIRS FOV must be at least 15% cloudy to be processed as a cloudy FOV, (3) using the PATMOS-X cloud mask to initialize the clear versus cloudy FOV identification necessary for radiance bias adjustments, (4) testing the spectral shifts suggested by STAR, and (5) measuring the quality of the resulting cloud fields through comparison with CALIOP. In the past six months the following accomplishments were added: (6) implemented and tested HIRS UT/LS algorithm with collocated CALIOP observations; (7) updated spectral shifts in HIRS forward model calculations that are used in clear-sky radiance bias and cloud top pressure routines – this led to significant improvements in modeled versus observed clear-sky radiance biases for the CO<sub>2</sub> bands; (8) changed cloudy versus clear-sky radiance threshold from 1.0 to 0.5 radiance units for the CO<sub>2</sub> bands thus adding sensitivity to thin high clouds; and (9) processed one year of NOAA-18 HIRS/4 data through to generation of cloud top pressures. As with MODIS, the SRF modifications improve our radiative transfer simulations of the upwelling radiances to the point where we greatly increase the sensitivity to optically thin cirrus.

Conversion of MODIS algorithm software to retrieve HIRS moisture layers (high, middle, and low level) and total column moisture continues. The synthetic regression coefficients for the statistical retrieval have been derived using a fast radiative transfer model; atmospheric characterization is achieved with a global set of atmospheric temperature, moisture, and ozone



profiles. The radiative transfer calculations of the HIRS spectral band radiances have been performed with and without spectral shifts for the training profiles using the JCSDA Community Radiative Transfer Model. HIRS instrument noise was added into the calculated spectral band radiances, and the resulting temperature-moisture-ozone profile / HIRS radiances were used to establish a statistical regression. Figure 36.4 shows an example result for one orbit on 13 August 2008. Incorporation of the surface emissivity and the H<sub>2</sub>O channel spectral shifts is producing the best results in comparison with MODIS and GDAS TPW.

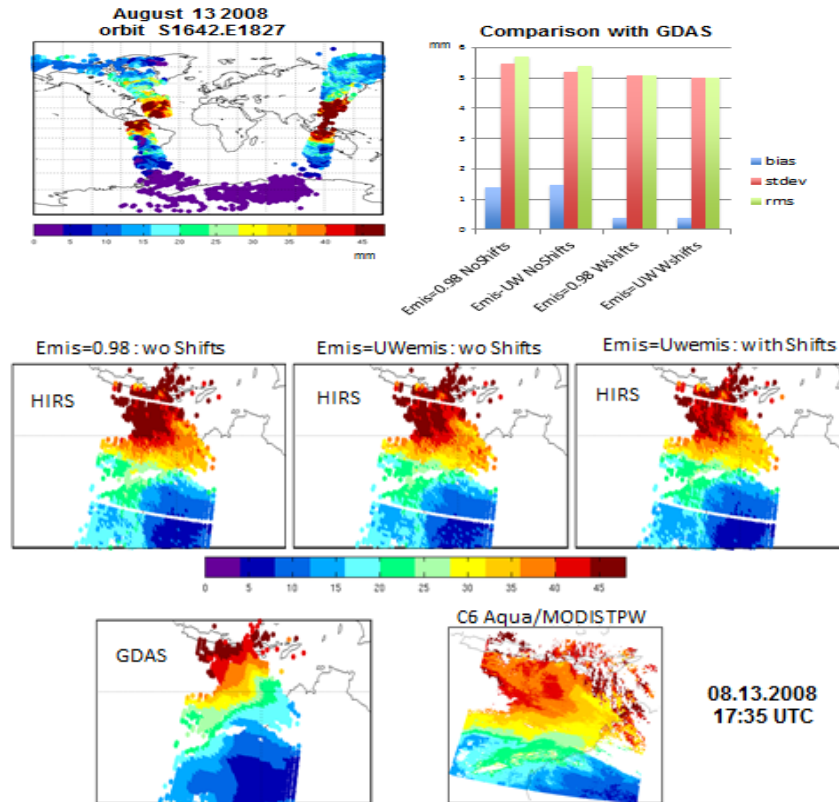


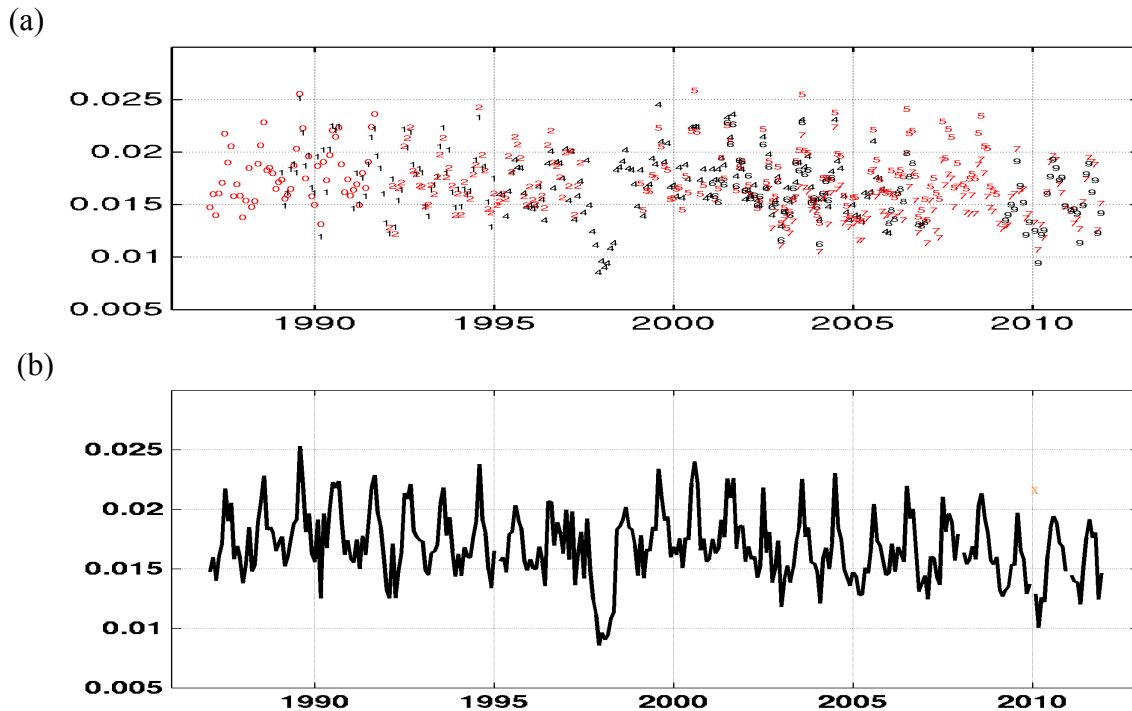
Figure 36.4. NOAA18/HIRS TPW compared to GDAS and Aqua/MODIS TPW.

### Investigating HIRS Stratospheric Cloud Trends

The presence of upper tropospheric / lower stratospheric (UT/LS) clouds has been estimated at the pixel level on the assumption that positive lapse rates above the tropopause imply that the more opaque spectral band sensitive to CO<sub>2</sub> or H<sub>2</sub>O in the atmosphere produces a brightness temperature warmer than a less opaque or nearly transparent infrared window spectral band. UT/LS cloud detection trends using measurements sensitive to CO<sub>2</sub> (BT14 > BT13.3) were compared with those using measurements sensitive to H<sub>2</sub>O (BT6.7 > BT11). CO<sub>2</sub> detection is more prevalent and somewhat out of phase with H<sub>2</sub>O detection; H<sub>2</sub>O presence in the UT/LS is variable while the CO<sub>2</sub> is relatively constant. In NOAA-14 data spanning 1995 through 2005, there are indications of UT/LS clouds in 0.7% of the observations from 60°N to 60°S using CO<sub>2</sub> absorption bands; however, in the region of the International Tropical Convergence Zone this increases to 2.5%. Expanding to all the HIRS sensors from NOAA-10 onwards, the UT/LS cloud detection maxima in the western Pacific region of the ITCZ shows a decreasing trend from 1987 to 1996, followed by an increasing trend from 1996 to 2001, and thereafter a decreasing trend resumes. The overall trend seems to be saying that deep convection in the tropics has been in a



slight decrease for the past twenty years (see Figure 36.5). A paper on this work has been accepted for publication by JGR.



**Figure 36.5.** (a) Individual monthly UT/LS cloud fraction detected by each HIRS over the ITCZ (20S to 40N latitude; 45 to 180 longitude) from Jan 1987 to Dec 2011. The number indicates the NOAA satellite (e.g., 0 for NOAA-10, 1 for NOAA-11, and so on) and the color indicates the orbit (red for descending morning and black for ascending afternoon). (b) Average monthly UT/LS cloud fraction detected by all HIRS on NOAA-10 through NOAA-19 over the ITCZ from Jan 1987 to Dec 2011.

### 37. CIMSS Research Activities in the VISIT Program

**CIMSS Task Leaders: Scott Bachmeier, Scott Lindstrom, Steve Ackerman**

**CIMSS Support Scientists: Tom Whittaker, Jordan Gerth**

**NOAA Collaborators: Tim Schmit, Robert Aune, Cooperative Institute for Research in the Atmosphere (CIRA), Forecast Decision Training Branch (FDTB)**

#### **NOAA Long Term Goals**

- Weather-Ready Nation

#### **NOAA Strategic Goals**

- Serve society's needs for weather and water
- Provide critical support for the NOAA mission

#### **CIMSS Research Themes**

- Satellite Meteorology Research and Applications
- Education and Outreach



## Proposed Work

The focus for the proposed work was on continuing to create Virtual Institute for Satellite Integration Training (VISIT) distance learning modules for a broad satellite meteorology audience, providing valuable satellite imagery interpretation materials that can be used in education and training, and also on maintenance and updates to existing satellite meteorology lesson material.

There remains a lack of adequate satellite-based education and training on a number of important topics that have direct relevance to typical forecast problems. Some of these topics include: identification of deformation zones, jet streaks, cloud patterns related to upper level wind fields, warm and cold moist conveyor belts, fog detection, turbulence signatures, and air quality.

The presence of fully-functioning Advanced Weather Interactive Processing System (AWIPS I and AWIPS II) workstations at CIMSS allows for faster development of new educational materials that address these types of satellite interpretation topics (and also facilitates more frequent updates to pre-existing modules) as new case study examples are observed on a daily basis. This real-time AWIPS capability gives CIMSS the unique ability to present these satellite interpretation topics in a context and format that the National Weather Service (NWS) forecaster is familiar with.

We also proposed to continue exploring the creation of lessons in the self-contained Weather Event Simulator (WES) format, which is an AWIPS training format that is widely used by NWS forecast offices. A pair of WES cases using simulated Advanced Baseline Imager (ABI) data have been developed at CIMSS (headed by Tim Schmit) as part of the GOES-R Proving Ground effort.

We planned to continue to leverage the real-time AWIPS capabilities at CIMSS to collect a variety of satellite and other remote sensing data during interesting or high societal impact weather events that occurred within a variety of regions and seasons. CIMSS also planned to continue to act as a “beta test site” for the next-generation AWIPS II, serving as a testbed for new satellite products in an operational environment (as was successfully accomplished with the “MODIS Products in AWIPS” and the “POES and AVHRR Satellite Data in AWIPS” projects). Imagery from the recently launched Suomi National Polar-orbiting Partnership (NPP) Visible Infrared Imaging Radiometer Suite (VIIRS) instrument is also now being created in an AWIPS format, with the infrastructure in place to distribute these high spatial resolution satellite images to NWS forecast offices. A new VISIT lesson “VIIRS Satellite Imagery in AWIPS” has been developed, to ensure forecaster readiness in concurrence with the flow of VIIRS data to their AWIPS workstations.

## Summary of Accomplishments and Findings

Forty-four “live” instructor-led VISITview teletraining sessions were given to a total of 58 NWS forecasters during this period, on the following eight topics: (1) “Interpreting Satellite Signatures,” (2) “TROWAL Identification,” (3) “The University of Wisconsin NearCasting Product,” (4) “Mesoscale Convective Vortices,” (5) “Objective Satellite-Based Overshooting Top and Enhanced-V Anvil Thermal Couplet Signature Detection,” (6) “Basic Satellite Principles,” (7) “Convective Cloud-Top Cooling and UW Convective Initiation,” and (8) “Forecaster Training for the GOES-R Fog/Low Stratus (FLS) Products.” These lessons – and others – are also available for NWS staff to access via the US Department of Commerce Learning Center (CLC).



In addition, CIMSS made significant contributions to the development of new MetEd modules “Advanced in Space-Based Nighttime Visible Observation,” “GOES-R ABI: Next Generation Satellite Imaging,” and “Suomi NPP: A New Generation of Environmental Monitoring Satellites.”

Two VISIT lessons that received significant revisions and updates were: (1) “Interpreting Satellite Signatures,” and (2) “Mesoscale Convective Vorticies.” A new VISIT lesson “VIIRS Satellite Imagery in AWIPS” was also completed and placed on the VISIT training calendar.

During the 01 April 2012 to 31 March 2013 period, 190 new posts were added to the CIMSS Satellite Blog: <http://cimss.ssec.wisc.edu/goes/blog> (the top hit in a Google search for the term ‘Satellite blog’). The CIMSS Satellite Blog continues to serve as an expanding, searchable library of satellite products and meteorological case studies that can be used in the development of future VISIT teletraining modules. The CIMSS Satellite Blog also acts as an important source of “Just-In-Time” satellite training material for weather events that have recently occurred (or to announce important changes in operational satellites or satellite products).

CIMSS also participated in local GOES-R Proving Ground Training activities with the National Weather Service forecast office in Milwaukee/Sullivan, WI (MKX) – CIMSS staff would travel to MKX to spend a day interacting with forecasters one-on-one about a variety of new satellite-based products (Cloud Top Cooling / UW Convective Initiation, Overshooting Top/Thermal Couplet Objective Detection, NearCasting, and Fog/Low Stratus Identification). The results of many of these CIMSS/MKX collaborative training visits are discussed on the GOES-R Proving Ground at NOAA’s Hazardous Weather Testbed site: <http://goesrhwt.blogspot.com/>.

Members of the CIMSS VISIT team also participated in GOES-R Proving Ground teleconference calls and VISIT/SHyMet teleconference calls. These activities are important because they help in the identification and prioritization of new satellite training topics, especially related to GOES-R Proxy data that are helping prepare NWS forecasters for the GOES-R era.



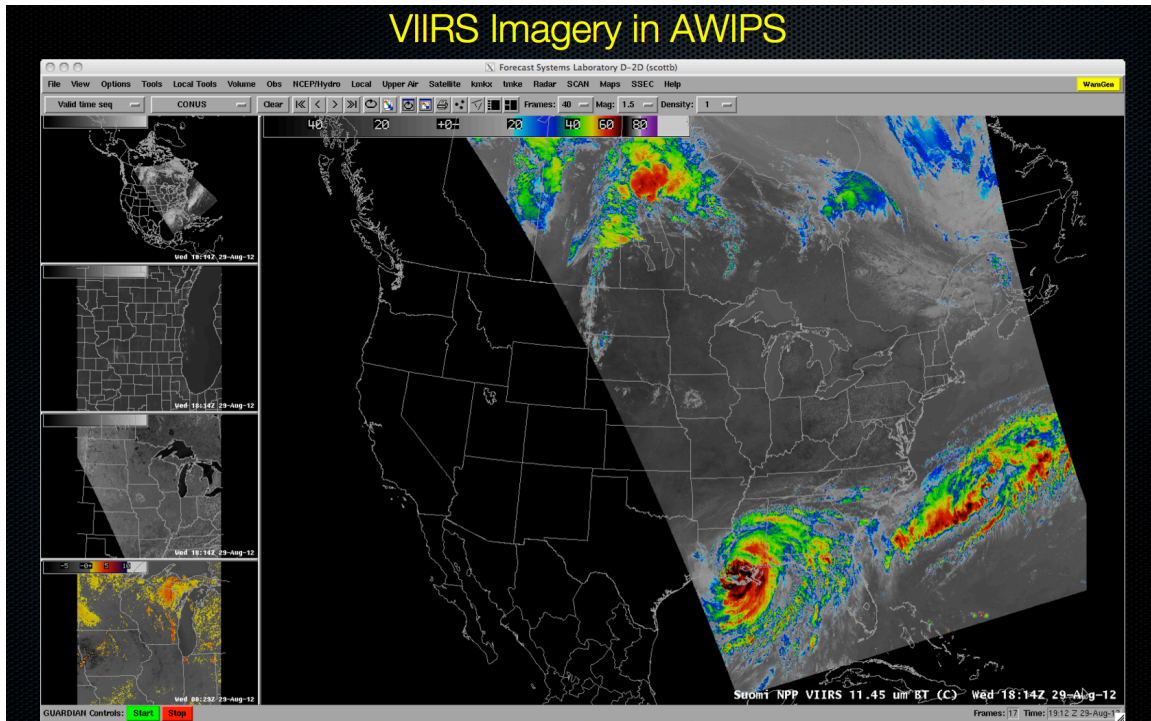


Figure 37.1. Title slide from the new “VIIRS Satellite Products in AWIPS” VISIT lesson.

### 38. CIMSS Research Activities in the SHyMet Program

**CIMSS Task Leaders: Scott Bachmeier, Scott Lindstrom, Steve Ackerman**

**CIMSS Support Scientists: Tom Whittaker, Jordan Gerth**

**NOAA Collaborators: Tim Schmit, Robert Aune, Cooperative Institute for Research in the Atmosphere (CIRA), Forecast Decision Training Branch (FDTB)**

#### **NOAA Long Term Goals**

- Weather-Ready Nation

#### **NOAA Strategic Goals:**

- Serve society’s needs for weather and water
- Provide critical support for the NOAA mission

#### **CIMSS Research Themes:**

- Satellite Meteorology Research and Applications
- Education and Outreach

#### **Proposed Work**

The focus for the proposed work was on continuing to create content for the Satellite Hydrology and Meteorology (SHyMet) course, which is designed for a broad satellite meteorology audience and provides valuable satellite imagery interpretation materials that can be used in education and training. The SHyMet course pulls together existing, new, and updated satellite training materials into a structured course with multiple tracks.

The presence of fully-functioning Advanced Weather Interactive Processing System (AWIPS I and AWIPS II) workstations at CIMSS allows for faster development of new educational materials that address important satellite interpretation topics (and also facilitates more frequent updates to pre-existing SHyMet modules or course tracks) as new case study examples are



observed on a daily basis. This real-time AWIPS capability gives CIMSS the unique ability to present these satellite interpretation topics in a context and format that the National Weather Service (NWS) forecaster is familiar with.

We plan to continue to leverage this real-time AWIPS capability at CIMSS to collect a diverse set of satellite and other remote sensing data during interesting or high societal impact weather events that occurred within a variety of regions and seasons. CIMSS also planned to continue to act as a “beta test site” for the next-generation AWIPS II, serving as a testbed for new satellite products in an operational environment (as was successfully accomplished with the “MODIS Products in AWIPS” and the “POES and AVHRR Satellite Data in AWIPS” projects). The latest source of new satellite data being evaluated is from the recently launched Suomi National Polar-orbiting Partnership (NPP) satellite.

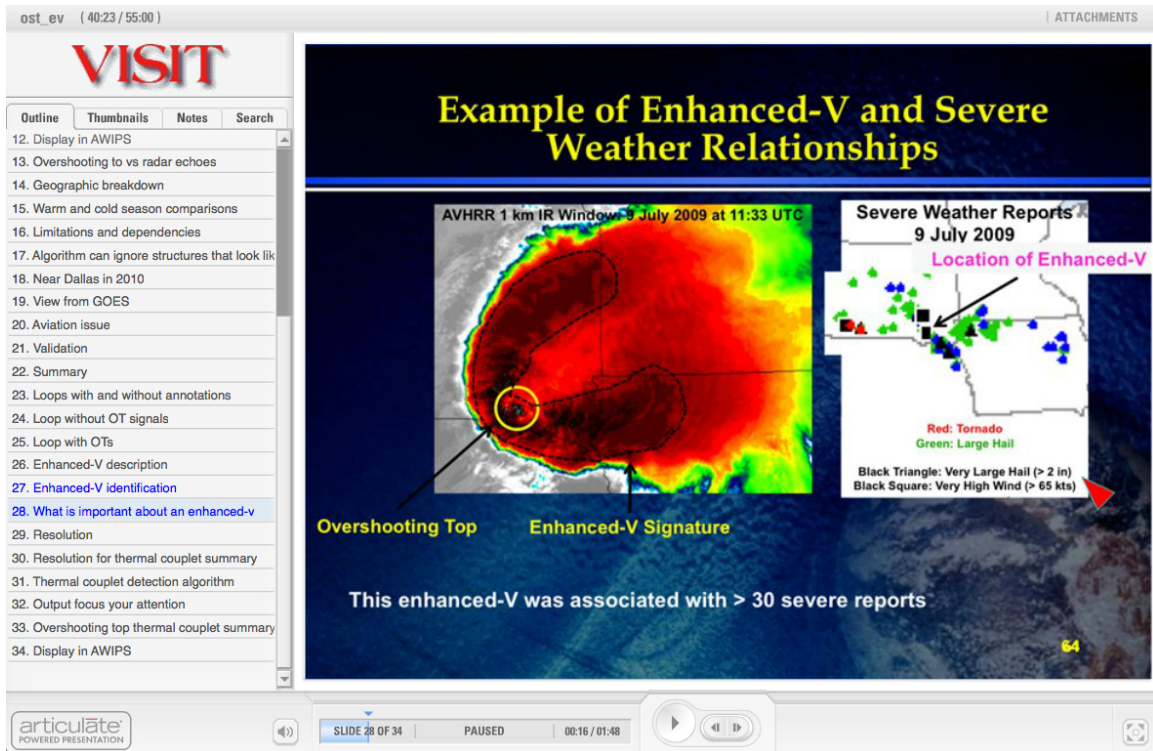
### **Summary of Accomplishments and Findings**

CIMSS contributed individual lessons that comprised the SHyMet Intern track, the SHyMet for Forecasters track, and the SHyMet: Severe Thunderstorm Forecasting track that comprise the overall SHyMet course. During the 01 April 2012 to 31 March 2013 period, 51 forecasters signed up for these three particular SHyMet course tracks, with 30 forecasters successfully completing all the training material.

Imagery from the Suomi National Polar-orbiting Partnership (NPP) Visible Infrared Imaging Radiometer Suite (VIIRS) instrument is now being created in an AWIPS format, with the infrastructure in place to distribute these high spatial resolution satellite images to NWS forecast offices. To address the training needs of this new source of satellite data, a new SHyMet lesson “VIIRS Satellite Imagery in AWIPS” was developed, to ensure forecaster readiness in concurrence with the release of the VIIRS data. This new lesson could then be added as an optional course for either of the other existing SHyMet tracks.

Members of the CIMSS SHyMet team continued to participate in monthly VISIT/SHyMet teleconference calls, which were important to help in the identification and prioritization of new satellite training topics (especially related to GOES-R Proxy data that are being used to help prepare NWS forecasters for the GOES-R era).

During the 01 April 2012 to 31 March 2013 period, 190 new posts were added to the CIMSS Satellite Blog: <http://cimss.ssec.wisc.edu/goes/blog> (the top hit in a Google search for the term ‘Satellite blog’). The CIMSS Satellite Blog continues to serve as an expanding, searchable library of satellite products and meteorological case studies that can be used in the development of future SHyMet lesson modules. The CIMSS Satellite Blog also acts as an important source of “Just-In-Time” satellite training material for weather events that have recently occurred (or to announce important changes in operational satellites or satellite products).



**Figure 38.1.** Screen capture from the “Objective Satellite-Based Overshooting Top and Enhanced-V Anvil Thermal Couplet Signature Detection” lesson, which is a component of the SHyMet: Severe Thunderstorm Forecasting track.

## 39. CIMSS Collaboration with the NWS Training Center

**CIMSS Task Leader: Wayne Feltz**

**NOAA Collaborator: Tim Schmit**

### NOAA Long Term Goals

- Weather-Ready Nation

### NOAA Strategic Goals

- Serve society’s needs for weather and water
- Support the nation’s commerce with information for safe, efficient and environmentally sound transportation
- Provide critical support for the NOAA mission

### CIMSS Research Themes

- Satellite Meteorology Research and Applications
- Satellite Sensors and Techniques
- Education and Outreach

### Proposed Work

CIMSS proposed to support the expanding use of satellite-based weather products by placing a CIMSS satellite scientist at the National Weather Service Training (NWS) Center in Kansas City, MO. The CIMSS scientist will provide leadership, satellite expertise, and meteorological support for the GOES-R Proving Ground efforts based at the NWS Training Center (NWSTC).



The successful candidate will work closely with CIMSS researchers, scientists at the NOAA/NESDIS/STAR and GOES-R Program Office and the staff at the NWS Training Center. The position is with UW-Madison and the position's duty station is in Kansas City, MO.

The position will be embedded within the NOAA/NWS Operations Proving Ground (OPG) at the NWSTC. The OPG provides the infrastructure and facilities to effectively transfer new and emerging scientific techniques, products, and services into NWS forecast office operations. The OPG actively engages in the research-to-operations process by supporting applied research, verifying the quality and scientific validity of new techniques and products, and providing a common venue for both forecasters and researchers to engage in developing and testing state-of-the-art aviation weather services.

This project will entail activities focused at maximizing the forecast value of geostationary satellite data and products, particularly activities centered on weather forecast office operations to improve forecast and warning services to the nation. The incumbent will interact with NWS operational forecasters and NESDIS satellite analysts to prepare them for new satellite dependent products that will become available operationally after the launch of the GOES-R satellite series.

### **Summary of Accomplishments and Findings**

Dr. Chad Gravelle was hired on 11 November 2011 to serve as National Weather Service Training Center (NWS TC) "Satellite Champion." He spent one week in Madison, WI at the National Weather Association annual meeting and is stationed permanently at the NWS TC in Kansas City, MO. CIMSS participated in the hiring process and Wayne Feltz is his immediate supervisor at UW-Madison. Chad is providing satellite liaison support for GOES-R baseline and future capability products.

## **40. CIMSS Collaboration with the Aviation Weather Center**

**CIMSS Task Leader: Wayne Feltz**

**NOAA Collaborator: Tim Schmit**

### **NOAA Long Term Goals**

- Weather-Ready Nation

### **NOAA Strategic Goals**

- Serve society's needs for weather and water
- Support the nation's commerce with information for safe, efficient and environmentally sound transportation
- Provide critical support for the NOAA mission

### **CIMSS Research Themes**

- Satellite Meteorology Research and Applications
- Satellite Sensors and Techniques
- Education and Outreach

### **Proposed Work**

CIMSS proposes to support the expanding use of satellite-based weather products by placing a CIMSS satellite scientist at the Aviation Weather Center (AWC) in Kansas City, MO. The CIMSS scientist will provide leadership, satellite expertise, and meteorological support for the GOES-R Proving Ground efforts based at the NWS Training Center (NWSTC).



The new position works closely with CIMSS researchers, scientists at the NOAA/NESDIS/STAR and GOES-R Program Office and the staff at the NWS Training Center. The position is with UW-Madison and the position's duty station is in Kansas City, MO.

This project will entail activities focused at maximizing the forecast value of geostationary satellite data and products, particularly activities centered on weather forecast office operations to improve forecast and warning services to the nation. The incumbent will interact with NWS operational forecasters and NESDIS satellite analysts to prepare them for new satellite dependent products that will become available operationally after the launch of the GOES-R satellite series.

### **Summary of Accomplishments and Findings**

Amanda Terborg was hired on 9 April 2012 to serve as Aviation Weather Center "Satellite Champion." She is stationed permanently at the Aviation Weather Center in Kansas City, MO. CIMSS participated in the hiring process and Wayne Feltz will be her immediate supervisor at UW-Madison. She has assisted in planning and function of Aviation Weather Testbed activities in February 2013. Results can be viewed from the following blog: <http://goesrawt.blogspot.com/>

## **41. Holding Teacher Workshops in Conjunction with ESIP Meetings**

**CIMSS Task Leader: Margaret Mooney**

**CIMSS Support Scientist: Steve Ackerman**

**NOAA Collaborator: Nina Jackson**

**NOAA Long Term Goals**

- Weather-Ready Nation

**NOAA Strategic Goals**

- Serve society's needs for weather and water

**CIMSS Research Themes**

- Education and Outreach

### **Proposed Work**

The Cooperative Institute for Meteorological Satellite Studies (CIMSS) organizes teacher workshops in conjunction with the Federation of Earth System Information Partners (ESIP) summer conferences. The first ESIP Teacher Workshop was held at the University of Southern California, Santa Barbara in 2009. The 2012 workshop was held in Madison Wisconsin. With support from NOAA, participating G6-12 teachers were invited to attend the ESIP conference plenary and an additional 1.5 days of workshop sessions that featured hands-on computer activities demonstrating ways that data and tools can be used in science classrooms. Sessions were led by ESIP members from NOAA, CIMSS, NASA, and other ESIP organizations.

### **Summary of Accomplishments and Findings**

The workshop themes were climate literacy and technology. Participating middle and high school science teachers were the first to borrow one of thirty iPads from the new CIMSS iPad Library, an innovative program where educators can borrow iPads like books for an entire school year. Local recognition at the University of Wisconsin-Madison for this program can be found on-line at <http://edinnovation.wisc.edu/>

Several climate-related apps were presented and shared at the workshop but the favorite by far was SatCam where users make observations of local cloud and surface conditions coordinated with



polar orbiting weather satellites. Coincidentally, the first observation the teachers made with their new iPads involved the Suomi NPP satellite.

A total of thirty-four educators registered for the ESIP Teacher Workshop and twenty-five borrowed iPads. Twenty-nine teachers filled out final evaluations and the majority (21) rated the experience as “excellent.” Two comments of note were “Thank-you NOAA & NASA!” and “Thank you for this opportunity to infuse real life up to date earth science data into my curriculum. I look forward to learning how to use the iPad to engage my students in data research.”



**Figure 40.1.** ESIP Teachers Workshop Group Photo 7/19/12.

### References

Mooney, Margaret; Dahlman, L.; Ackerman, S.; Jackson, N.; Chambers, L. H. and Whittaker, T., 2013: The CIMSS iPad Library and ESIP Teacher Workshops. Symposium on Education, 22nd, Austin, TX, 6-10 January 2013. American Meteorological Society, Boston, MA.

Mooney, Margaret; Ackerman, S.; Jackson, N. L. and Whittaker, T., 2011: Infusing satellite data into earth science education with SAGE, ESIP and SNAPP. Symposium on Education, 20th, Seattle, WA, 23-27 January 2011. American Meteorological Society (AMS), Boston, MA.



## Appendix 1: List of Awards to Staff Members

### 2013

**Bormin Huang:** SPIE Fellow

### 2012

**Christopher Velden:** UW Chancellor's Award for Excellence in Research: Independent Investigator

**Graeme Martin and Dave Tobin:** Individual "Best Poster" awards at the International TOVS Study Conference (ITSC-18) in Toulouse, France.

**Jordan Gerth:** First place, Graduate Student Oral Presentation, National Weather Association 2012

**Bill Line:** First place, Graduate Student Poster Presentation, National Weather Association 2012

**Jun Li and Zhenglong Li:** Certificate of Recognition presented in appreciation for all of your hard work and dedication which contributed to the successful launch and commission of Suomi National Polar-orbiting Partnership satellite system.

**Christopher Moeller and Dan LaPorte:** NASA Group Achievement Award as members of the Suomi NPP Mission Development Team.

**Tom Whittaker:** Appreciation for Service as Co-Chair for the Committee on Environmental Information Processing Technology (formerly IIPS)

**Bill Line:** 2012 Unidata Users' Workshop student stipend

**Jordan Gerth:** Wisconsin Space Grant Consortium Graduate Fellowship Award

### 2011

**James Kossin:** NOAA Office of Oceanic and Atmospheric Research's Gold Medal for excellence in research and data stewardship leading to a more confident assessment of the influence of human-induced climate change on hurricanes.

**Timothy Schmit:** Department of Commerce Silver Medal "For revolutionizing NOAA Science Tests for geostationary satellites, significantly reducing the likelihood of a single satellite configuration."

**Scott Bachmeier, Wayne Feltz, Mathew Gunshor, James Nelson, Christopher Schmidt, Anthony Schreiner, Justin Sieglaff, David Stettner, William Straka III, Christopher Velden, and Steven Wanzong:** NOAA-CIMSS Collaboration Award "For working with NOAA in revolutionizing NOAA Science Tests for geostationary satellites, significantly reducing the likelihood of a single satellite configuration"

**Tim Schmit:** The T. Theodore Fujita Research Achievement Award from the National Weather Association (NWA) "for excellence in promoting and extending the use of satellite data within the operational community currently and in the future"

**Steven Ackerman:** Elected Fellow of the Wisconsin Academy of Sciences, Arts and Letters

**Jordan Gerth:** Wisconsin Space Grant Consortium Graduate Fellowship Award

**Andrew Heidinger:** NOAA Employee of the Month for the first delivery of an externally-generated climate data record to NCDC as part of their CDR program

**Justin Sieglaff:** NOAA-CIMSS Collaboration Award "For providing near real-time volcanic ash information in the critical period following the eruption of the Eyjaafjallajokull volcano"

**William Straka III:** NOAA-CIMSS Collaboration Award "For developing an enhanced production system for satellite-based real-time radiation data from NOAA's operational geostationary satellites"



## **2010**

**Thomas Achtor and Wayne Feltz:** 2010 University of Wisconsin Police Department  
Community Service Award for Providing Weather Forecasts for Special Events in Camp  
Randall Stadium

**Steven Ackerman:** NASA Exceptional Public Service Medal

**Steven Ackerman and Tom Whittaker:** Finalist in NSF International Science and Engineering  
Visualization Challenge

**Scott Bachmeier:** NOAA Team Member of the Month for his efforts to improve public  
awareness of NOAA satellite applications, both for the general public and for NOAA

**Kaba Bah:** Best Poster Presentation at the 35th National Weather Association Annual Meeting  
for “Preparation for use of the GOES-R Advance Baseline Imager (ABI)”

**Jordan Gerth:** Wisconsin Space Grant Consortium Graduate Fellowship Award

**Andrew Heidinger:** Department of Commerce Bronze Medal: “For developing an enhanced  
production system for satellite-based, real-time radiation data from NOAA's operational  
geostationary satellites”

**Michael Pavolonis:** Department of Commerce Bronze Medal: “For providing near real-time  
volcanic ash information in the critical period following the eruption of the  
Eyjafjallajökull volcano”





## Appendix 2: CIMSS Collaborations with other Cooperative Institutes

CIMSS Current Collaborations with Cooperative Institutes*							
CIMSS Scientist(s)	Collaborator(s)	Topic	CIRA	CIRES	CREST	CICS	CIMMS
Velden, C. Wanzong, S.	Lindsey, D.	GOES-RRR	X		X		
Rozoff, C.	Knaff, J. DeMaria, M.	Tropical cyclone structure (GOES-RRR)	X				
Liu, Y.	Tschudi, M.; Romanov, P.	VIIRS snow and ice EDRs		X	X		
Lee, Y-K.	Kongoli, C.	GCOM-W1 AMSR2 cryosphere products				X	
Wang, X.	Tschudi, M.	NPP science team support of cryosphere products		X			
Kossin, J.	Schreck, C.	Kelvin waves in tropical cyclogenesis				X	
Kossin, J. Rozoff, C. Velden, C	DeMaria, M.	Improvements to SHIPS rapid intensification index	X				
Li, J.	Zupansky, M.	Utility of GOES-R instruments for hurricane data assimilation and forecasting	X				
Schmit, T Gunshor, M.	Lindsey, D. Grasso, L.	10.35 micron window on GOES-R ABI	X				
Velden, C.	DeMaria, M.	JPSS	X				
Otkin, J.	Grasso, L.	Proxy radiance data testbed (GOES-RRR)	X				
Nelson, J.	Lindsey, D.		X				
Pavolonis, M. Sieglaff, J.	Lindsey, D.	Probabilistic nearcasting of severe convection using GOES convective cloud properties, NEXRAD, NWP	X				
Schmidt, C.	Schroeder, W.	Active fire and hot spot characterization (FIRE)				X	
Schmidt, C.	Brummer, R.	Active fire and hot spot characterization (FIRE)	X				
Ackerman, S. Mooney, M.	Buhr, S. Lynds, S.	On-line climate change course for undergraduates		X			



CIMSS Cooperative Agreement Report  
1 April 2012 – 31 March 2013

Ackerman, S. Mooney, M.	Arkin, P.	Weather and Climate connections for 3D spherical displays				X	
Walther, A. Heideinger, A.		GIMPAP: Fusing GOES obs and sky cover analysis products		X			
Wimmers, A.	Lindsey, D.	Enhanced downslope windstorm prediction w/GOES warning indicators	X				
Sieglaff, J.	Lakshmanan, V.	Daytime enhancement of UWCI/CT algorithm in areas of thin cirrus					X
Otkin, J.	Jones, T.	Data assimilation					X

\*Does not include collaborations with other NOAA affiliated organizations, universities, centers, laboratories, etc.



## Appendix 3: Publications Summary

Below are three tables summarizing CIMSS publications in the recent years. A complete listing of Publications and Conference Reports are provided in Appendix 8 and 9.

**Table 1** below indicates the number of reviewed and non-reviewed papers that include a CIMSS or ASPB scientist as first author during the period 2011-2013. Two additional columns show lead authorship of NOAA scientists outside of ASPB or lead authors from other institutions or organizations. **Table 2** below shows collaborations on papers between or among Institute, ASPB and NOAA authors outside of ASPB. Note that data for 2013 is incomplete.

During the period 2011-2013, 52% of all articles included a NOAA co-author.

A bibliography of Advanced Satellite Products Lab (ASPB) publications is available at: [http://library.ssec.wisc.edu/research\\_Resources/bibliographies/aspb](http://library.ssec.wisc.edu/research_Resources/bibliographies/aspb).

**Table 1:** Peer Reviewed and Non Peer Reviewed journal articles having CIMSS, ASPB, NOAA or Other lead authors, 2011-2013.\*

	Inst Lead			ASPB Lead			NOAA Lead			Other Lead		
	2011	2012	2013	2011	2012	2013	2011	2012	2013	2011	2012	2013*
<b>Peer Reviewed</b>	25	26	6	1	1	1	6	8	2	36	41	12
<b>Non Peer Reviewed</b>	1	2	2	0	1	0	0	0	0	0	1	0

\*2013 incomplete: does not include forthcoming papers or papers submitted for publication.

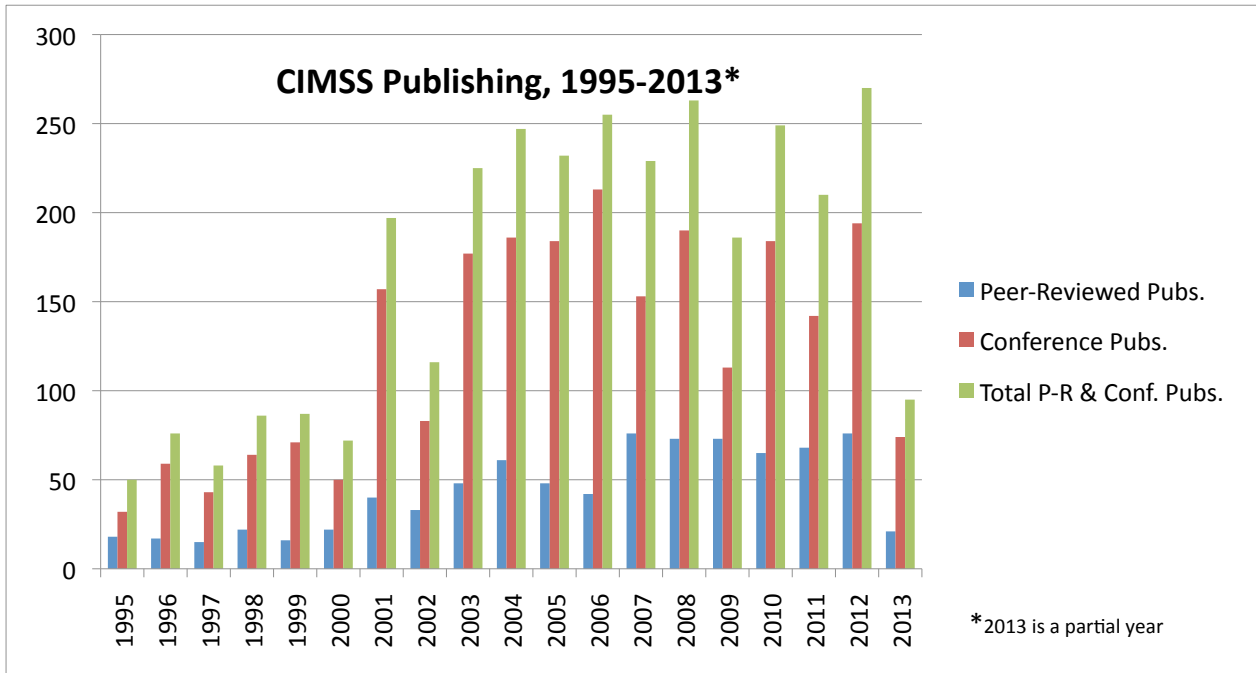
**Table 2:** Peer Reviewed and Non Peer Reviewed journal articles having one or more CIMSS, ASPB, or NOAA co-authors, 2011-2013.\*

	Institute Co-Author			ASPB Co-Author			NOAA Co-Author		
	2011	2012	2013*	2011	2012	2013	2011	2012	2013*
<b>Peer Reviewed</b>	85	120	43	21	22	8	49	47	9
<b>Non Peer Reviewed</b>	2	5	3	1	2	2	0	0	1

\*2013 incomplete: does not include forthcoming papers or papers submitted for publication.



**Table 3:** CIMSS Publishing History, showing peer reviewed and conference publications for the period 1995-2013.



\*2013 incomplete: does not include forthcoming papers or papers submitted for publication and for all years, does not include non-reviewed papers.



## Appendix 4: CIMSS Staff and Student Hours on NOAA Cooperative Agreement Projects

Below is a listing of all CIMSS staff members who charged more than 5% of their time to the CIMSS-NOAA Cooperative Agreement projects during the period 1 April 2012 through 31 March 2013. A total of 57 staff members charged 50% of their time or greater to these projects. A total of 122 staff members charged 5% of their time or greater to these projects.

<b>Name</b>	<b>Category</b>	<b>Total Hrs</b>	<b>FTE %</b>
Botambekov, Denis	Researcher I	1,754	100%
Bachmeier, Anthony	Researcher II	1,754	100%
Jung, James	Scientist I	1,754	100%
Terborg, Amanda	Researcher I	1,754	100%
Liu, Yinghui	Researcher I	1,754	100%
Lee, Yong-Keun	Researcher I	1,754	100%
Martin, Graeme	Computer Scientist I	1,754	100%
Walther, Andi	Researcher I	1,754	100%
Bah, Momodou	Researcher I	1,754	100%
Gunshor, Mathew	Researcher II	1,754	100%
Calvert, Corey	Researcher I	1,754	100%
Gravelle, Chad	Researcher I	1,752	100%
Li, Yue	Scientist, PostDoc	1,732	99%
Li, Zhenglong	Researcher I	1,724	98%
Mindock, Scott	Computer Scientist II	1,712	98%
Cintineo, John	Researcher I	1,708	97%
Li, Jinlong	Researcher II	1,708	97%
Straka, William	Researcher I	1,692	96%
Wanzong, Steven	Researcher II	1,678	96%
Nelson, James III	Researcher III	1,637	93%
Brunner, Jason	Researcher I	1,636	93%
Lenzen, Allen	Researcher III	1,511	86%
Olander, Timothy	Researcher II	1,488	85%
Monette, Sarah	Researcher I	1,447	82%
Dworak, Richard	Manager III	1,415	81%
Sieglauff, Justin	Researcher I	1,412	81%
Schaack, Todd	Researcher III	1,408	80%
DeSlover, Daniel	Researcher II	1,398	80%
Moeller, Christopher	Scientist I	1,371	78%
Gerth, Jordan	Student, Graduate	1,350	77%
Zhang, Hong	Researcher II	1,348	77%
Hiley, Michael	Researcher I	1,324	75%
Cureton, Geoffrey	Manager I	1,296	74%
Schiffer, Eva	Computer Programmer I	1,292	74%
Lindstrom, Scott	Researcher II	1,230	70%
Lewis, William	Researcher I	1,228	70%
Schreiner, Anthony	Researcher III	1,220	70%
Nebuda, Sharon	Researcher I	1,198	68%
Borg, Lori	Researcher I	1,192	68%
Knuteson, Robert	Scientist I	1,157	66%
Foster, Mike	Researcher I	1,128	64%



Hoese, Dave	Student, Undergrad	1,121	64%
Mielikainen, Jarno	Engineer I	1,120	64%
Cronce, Lee	Researcher I	1,088	62%
Line, William	Student, Graduate	1,080	62%
Wang, Pei	Student, Graduate	1,073	61%
Hoffman, Jay	Researcher I	1,040	59%
Feltz, Wayne	Scientist I	1,012	58%
Smith, Nadia	Researcher I	984	56%
Feltz, Michelle	Student, Undergrad	980	56%
Weisz, Elisabeth	Researcher II	957	55%
Wang, Xuanji	Scientist, PostDoc	936	53%
Roubert, Lisha	Researcher I	934	53%
Tobin, David	Scientist I	932	53%
Davies, James	Computer Programmer II	904	52%
Vasys, Egle	Executive Assistant	886	51%
Hart, Caitlin	Student, Graduate	878	50%
Garcia, Raymond	Computer Scientist III	866	49%
Lim, Agnes	Scientist, PostDoc	856	49%
Strabala, Kathleen	Researcher III	852	49%
Huang, Hung-Lung	Scientist III	836	48%
Stettner, David	Researcher I	829	47%
Avila, Leanne	Documentation Specialist II	796	45%
Schmidt, Christopher	Researcher III	796	45%
Rink, Thomas	Computer Scientist I	784	45%
Rogal, Marek	Scientist, PostDoc	720	41%
Quinn, Greg	Computer Programmer I	716	41%
Oo, Min Min	Scientist, PostDoc	704	40%
Gjermo, Britta	Student, Undergrad	691	39%
Roman, Jacola	Student, Graduate	661	38%
Huang, Bormin	Scientist II	639	36%
Kuehn, Ralph	Researcher I	632	36%
Rozoff, Christopher	Researcher I	623	35%
Li, Jun	Scientist II	612	35%
Taylor, Joseph	Engineer II	607	35%
Feltz, Joleen	Researcher I	604	34%
Herndon, Derrick	Researcher I	600	34%
Jasmin, Tommy	Computer Scientist II	568	32%
Kulie, Mark	Researcher I	564	32%
Olson, Erik	Computer Scientist I	563	32%
Molling, Christine	Researcher II	558	32%
Dengel, Russell	Computer Programmer III	540	31%
Greenwald, Thomas	Scientist I	532	30%
Nelson, Kyle	Student, Graduate	525	30%
Garms, Elise	Student, Graduate	510	29%
Frey, Richard	Computer Programmer III	510	29%
Velden, Christopher	Scientist III	504	29%
Otkin, Jason	Researcher II	502	29%
Huang, Melin	Scientist I	472	27%
Gumley, Liam	Researcher III	456	26%
Beavers, Jonathan	Computer Programmer I	418	24%
Price, Erik	Student, Undergrad	409	23%
Borbos, Eva	Researcher II	376	21%



Revercomb, Henry	Scientist III	338	19%
Wimmers, Anthony	Scientist I	315	18%
Petersen, Ralph	Scientist III	276	16%
Nagle, Frederick	Post Retirement Rehire	264	15%
Cintineo, Rebecca	Researcher I	262	15%
Sears, John	Researcher I	256	15%
Menzel, Wolfgang	Scientist III	254	14%
Smith, William, Sr	Scientist III	245	14%
Hallock, Kevin	Computer Programmer I	238	14%
Santek, David	Scientist I	232	13%
Bearson, Nicholas	Researcher I	212	12%
Lazzara, Mathew	Researcher III	203	12%
Holz, Robert	Researcher II	200	11%
Achtor, Thomas	Scientist III	194	11%
Baum, Bryan	Scientist II	160	9%
Whittaker, Thomas	Computer Scientist III	159	9%
Mikolajczyk, David	Researcher I	149	8%
Batzli, Samuel	Scientist I	140	8%
Ramasubramanian, Siva	Student, Undergrad	134	8%
Richter, Erik	Student, Undergrad	112	6%
Pandey, Abhishek	Student, Graduate	112	6%
Subramani, Guru	Student, Undergrad	105	6%
Schiff, Louis	Student, Undergrad	101	6%
Bellon, Willard	Data Manager II	99	6%
Zheng, Jing	Scientist, PostDoc	96	5%
Ackerman, Steven	Scientist III	93	5%
Moeller, SzuChia	Researcher II	86	5%
Thom, Jonathan	Researcher II	84	5%
	Technical Computing		
Stroik, Jesse	Specialist II	83	5%



## **Appendix 5: Research Topics of Current CIMSS Graduate Students and Post-Doctors**

### **NOAA Funded Graduate Students and Post-Doctors**

#### ***Barbara Arvani***

Ph.D. research: Working with Dr. Brad Pierce and other CIMSS scientists on linking particulate matter (PM) measured at ground with satellite Aerosol Optical Depth (AOD) retrievals within the Po Valley, Italy and implementation of the IDEA-International aerosol forecasting system at the University of Modena and for air quality assessments/forecast.

#### ***Kaba Bah***

Ph.D Thesis topic: This study will focus on using nested global-to-regional air quality forecast and chemical data assimilation models, satellite, airborne and ground based insitu and remote measurements to interpret air quality in the Denver, CO region during the NSF sponsored Front Range Air Pollution and Photochemistry Experiment (FRAPPÉ) field campaign (July 2014). CIMSS, in collaboration with the LASP at the University of Colorado- Boulder will be deploying ground based remote sensing instruments during FRAPPE including the SSEC Automated High Spectral Resolution Lidar (AHSRL), Atmospheric Emitted Radiance Interferometer (AERI), and LASP Solar Spectral Flux Radiometer (SSFR) which will be used to provide continuous measurements of clouds, aerosols, ozone, carbon monoxide, and atmospheric temperature and water vapor. These measurements will be assimilated within nested RAQMS/WRF-CHEM.

#### ***Jordan Gerth***

PhD Thesis title: “Relating Multi-source Cloud Observations to Numerical Model Output via Optimization.” A sky cover product comprised of in-situ and remote observations is under development. A framework to develop a mathematical and physical relationship between the new sky cover product and existing forecast model cloud variables is proposed. The intended result is to produce better forecasts of sky cover for the general public and weather-sensitive industries, such as the aviation and energy sectors.

#### ***Caitlin Hart***

M.S. Thesis title: “Interpretation of Small Particle Signatures in Satellite Observations of Convective Storms.” Strong updrafts in mid-latitude convective storms eject supercooled water droplets into the tropopause and lower stratosphere (Wang, 2003). These droplets flash freeze at very low temperatures, causing them to be significantly smaller than the particles in the glaciated anvil top. Using the Daytime Cloud Optical Microphysical Properties (DCOMP) retrieval (Walther, et al., 2012) applied to GOES-East data, discrete minima are observed in the vicinity of the updraft core of severe thunderstorms in the effective radius retrieval. Several thunderstorms were analyzed for small particle signatures, which were compared to 30 dBZ NEXRAD echo to heights. An example from June 27, 2008 over Illinois of an effective radius retrieval using MODIS data indicates several particle signatures that were not observable in GOES retrievals. This example demonstrates the importance of spatial resolution in correctly identifying updraft-related small particle regions.

#### ***Yue Li***

Post Doc Research: We studied the diurnal variations of land surface emissivities (LSE) using geostationary satellite data observations. Better understanding of LSE change can improve the





retrieval accuracy from satellite observations and reduce uncertainties in number weather predictions. So the aim of this study is to investigate the magnitude and factors resulting variations of the LSE change.

b. We assessed the quality of CrIMSS post-launch EDR product. This assessment is important to report possible biases and deficiencies prior to the official release of CrIMSS product.

### ***Agnes Lim***

PhD Thesis title: "Assimilation of AIRS Radiances of Short Term Regional Forecasts using Community Models." The aim of this project is to assess the forecast impact brought by assimilation of clear sky AIRS radiances on short term regional forecasts. This study uses community model to carry out data assimilation and numerical weather prediction. Conclusions drawn from these study show that non-operational systems need to be tuned prior to running experiments and that the assimilation of clear sky AIRS radiances is slightly positive for short term regional forecasts.

Post Doc Research Topic : Geo hyperspectral data OSSE. The aim of this project is to assess the potential forecast impact benefit brought by assimilating geostationary hyperspectral data whose spatial and temporal resolutions are much higher than the current low earth orbit hyperspectral sounders.

### ***William Line***

M.S. Thesis title: "Using Isentropic Techniques to Improve the Utility of GOES Moisture Observations."

The CIMSS NearCasting model is a lagrangian trajectory model that dynamically projects GOES sounding observations of temperature and moisture forward in time to provide detailed, hourly updated information about the moisture and stability structure of the pre-convective environment 1-9 hours in advance. This study seeks to develop an improved version of the model by computing trajectories in an isentropic framework, since the GOES IR retrievals are made under clear sky conditions, where flow is primarily adiabatic. In addition to providing more accurate stability and shear information, the isentropic NearCasting model allows for the depiction of lift and total isentropic layer moisture, improving forecasts of the timing, location, and type of convection that may occur.

### ***Michael Pavolonis***

Ph.D. Thesis title: "Satellite retrievals and analysis of volcanic ash cloud properties." Volcanic clouds impact climate, biogeochemical processes, cloud physics, human health, and aviation (airborne volcanic ash can severely damage aircraft). While all of these impacts are important, the primary motivation behind this dissertation is to utilize satellite data to improve the accuracy and timeliness of the volcanic ash cloud guidance that is operationally provided to the aviation community through improved understanding of the physical behavior of ash clouds. The main objectives of the research are:

- Develop and validate a robust physically based methodology for determining the dominant composition of clouds using weather satellites, with the primary goal of objectively identifying volcanic ash clouds.
- Develop and validate a physically based methodology for retrieving the height, mass loading (mass per unit area), and effective particle radius of volcanic ash clouds using satellite-based infrared measurements commonly available on weather satellites.
- Utilize the satellite-derived ash cloud properties and numerical weather prediction model fields to characterize the macro-physical, micro-physical, and dynamical properties of airborne volcanic ash in space and time, within the context of the background atmospheric state.



### ***Jacola Roman***

M.S. Thesis title: "Climatological Analysis and Assessment in Global Climate Models and Observations of Precipitable Water Vapor (PWV) and Sea Surface Temperature (SST)". This study examines regional monthly mean and seasonal trends in PWV using ground-based GPS measurements as well as satellite (AIRS and AMSR-E) observations and reanalysis (NARR). Additionally, the study examines the simulations of the GCMs of SST for two different scenarios (decadal run 1980 and decadal run 2000). A comparison to observations will be done, in an attempt to show which scenario best stimulates the observations from 2000-2010. Once a scenario is distinguished, the assessment of GCMs at simulating the PWV observations will be examined and evaluated, similar to the analysis done on the observations.

### ***Matthew Sitkowski***

Ph.D. Thesis title: "Investigation and Prediction of Hurricane Eyewall Replacement Cycles". This study develops a probabilistic model that determines the likelihood of hurricane secondary eyewall formation and subsequent eyewall replacement cycles. The model incorporates environmental and satellite-based features that are used to identify when conditions are favorable for the formation of a secondary eyewall. Flight-level aircraft data are utilized to determine the intensity and structure changes associated with eyewall replacement cycles. In addition, the role of the decaying inner eyewall, or relict inner eyewall circulation, on the evolution of the inner-core structure, intensity, and pressure-wind relationship of the storm near the end of and following an eyewall replacement cycle is examined.

### ***Pei Wang***

Ph.D. Thesis topic: Research interest is using high spatial and temporal resolution satellite data to understand hurricane evolution. Both WRF/3DVAR and WRF/GSI data assimilation system are used in the research. Hurricane Ike has been simulated with AIRS retrieval data using WRF/3DVAR, and Irene with AMSU-A and AIRS radiance data using WRF/GSI. It is found that AIRS temperature retrieval data has positive impacts on Ike simulation, especially for the results of hurricane track. The AIRS moisture retrieval data has few impacts than temperature data. The further step is to find out the effects of AIRS retrieval data on hurricane Irene using WRF/GSI. The expected year of graduation is about four years.

## **Students Funded on other projects than NOAA**

### ***Mike Hiley***

M.S. Thesis title: "Triple Frequency Radar Reflectivity Signatures of Snow: Observations and Comparisons to Theoretical Ice Particle Scattering Models." This study utilizes aircraft data from the 2003 NASA Wakasa Bay AMSR Precipitation Validation Campaign to reduce uncertainties in the active microwave remote sensing of frozen precipitation. The main goal is to compare the latest theoretical modeling of scattering properties of complex aggregate snowflakes to actual radar reflectivity observations. These new models exhibit a distinct behavior when Ku-Ka band Dual Frequency Ratio (DFR) is compared to Ka-W band DFR. This unique signature leads to the potential for ice habit discrimination when radar observations at all three of these frequencies are available. The Wakasa Bay dataset is particularly applicable to this study because observations at all three frequencies of interest are available from the same aircraft. The initial results provide observational confirmation of the distinct triple frequency behavior of complex aggregate scattering models and provide insight for future single and dual frequency snowfall retrievals.



### ***Burcu Kabatas***

Paper title: "Quantification of Saharan Dust on Anatolian Peninsula via RAQMS Modeling." Summarized the results of collaborative research using the Real-time Air Quality Modeling System (RAQMS) model to explain the possible effects of Saharan dust transport on high levels of surface PM10 measured in the Anatolian Peninsula during April 2008. Comparison between RAQMS dust forecasts and ground observations suggest a significant contribution of Saharan dust to the surface PM10, which is consistent with MODIS Terra and Aqua aerosol optical depth measurements which range from 0.6 to 0.8 during the period of highest PM10. The vertical distribution of CALIPSO aerosol extinction measurements suggest that the dust cloud extended up to 6km during the period from April 11 to 18, 2008.

### ***Brent Maddux***

Ph.D. Thesis title: "Analyses of the MODIS Global to Regional Cloud Properties and Uncertainty." This study analyzes the MODIS global and regional cloud property data records. Cloud property histograms and statistics are utilized to characterize the global cloud property fields and attribute systematic errors and biases to their source. In conjunction with the GEWEX Cloud Climatology Comparison working group, this effort will help characterize the MODIS data records for future improvement and potential merger with other satellite data records.

### ***Aronne Merrelli***

Ph.D. Thesis title: "Far Infrared Remote Sensing of Cirrus Clouds and Upper Troposphere Thermodynamic Properties." This research investigates the potential of high spectral resolution far infrared (FIR) radiance measurements (100 - 600 1/cm) for ice particle property retrievals and upper troposphere temperature and water vapor profiles. Line by line and discrete ordinates radiative transfer codes are used to model far infrared radiance spectra, for atmospheric columns including various amounts of water vapor and ice clouds. An optimal estimation algorithm is used to evaluate the retrieval and the information content of the radiance spectra. The FIR spectra show significant information in the upper troposphere, especially in the water vapor profile, and show a potential advantage over the state of the art mid infrared (MIR) measurements from satellites. In addition, the FIR spectra show increased sensitivity to ice cloud properties, especially for cases involving thick clouds where the ice spectral signature saturates in the MIR.

### ***Jacob Miller***

M.S. Research topic: This research is looking at the temporal and spatial extent of Arctic Leads, located north of Alaska. This is done by using MODIS retrieved data in an algorithm to detect the cloud cover, and find open "windows" with no clouds. In these windows another algorithm determines the coverage of ice and the orientation and width of leads based off a 95% threshold, which is then mapped, and later to be projected back on to a common grid. Currently the research involves case studies covering the time from Feb-April on selected years, in order to further improve/test the algorithms and research hypothesis.

### ***Nate Miller***

M.S. Thesis title: "Microwave Radiometer Observations of Surface-Based Inversions above the Greenland Ice Sheet." A pair of Microwave Radiometers (MWRs) covering the spectral range from 22.2 to 150 GHz, are part of an integrated suite of remote sensing instruments deployed to Summit Station in central Greenland by a NSF funded project dubbed ICECAPS. Using calibrated brightness temperatures from the MWRs, retrievals of liquid water path, precipitable water vapor and temperature profiles are collected in this extremely cold and dry environment. Surface based inversions are a predominant feature across the Greenland ice sheet and monthly



values of depth, intensity, and occurrence are shown for 2011. The atmospheric state is measured twice daily at Summit via radiosonde sounding, although the advantage of using the MWRs is headlined by their close-to autonomous data collection at high temporal resolution. Within a matter of a few hours the presence of a liquid bearing cloud leads to decay in the strength of the inversion thus changing the stability of the boundary layer. Hence a possible increase in cloud frequency or a change in cloud microphysics above the Greenland ice sheet would further inhibit inversions and lead to changes in the interaction between the atmosphere and ice.

### ***Kyle Nelson***

MS project title: "Low-Level Liquid Cloud Surface Radiative Forcing over Greenland Using MODIS."

The study seeks to diagnose and quantify the surface radiative forcing of low-level liquid clouds over Greenland using MODIS. This study builds upon results obtained by the ICECAPS field campaign with the goal to reproduce their findings using MODIS satellite data and expand the study to the entire Arctic and develop a 10-year climatology.

### ***Ilya Razenkov***

Ph.D. Research topic: "Atmospheric temperature profile measurements using a University of Wisconsin High Spectral Resolution Lidar." Atmospheric temperature profile measurements using a University of Wisconsin-Madison High Spectral Resolution Lidar are proposed in this study. Doppler broadening of the backscattered light depends on the air temperature and pressure. This effect can be utilized to infer the information about the atmospheric temperature profile. A combination of the narrow bandpass Fabry-Perot etalon and molecular iodine absorption filter can be used to detect the temperature sensitive changes of the lidar returns.

### ***John Rausch***

Ph.D. Research Topic: "Improvement of MODIS Cloud Property Retrievals through an Adiabatic Method." This work involves estimating MODIS cloud optical depth and multispectral effective radius retrievals for stratiform boundary layer clouds through the use of an adiabatic retrieval method rather than the vertically homogeneous method currently employed in the MODIS Cloud Product. The goal of this research is to provide a more realistic estimate of boundary layer cloud microphysical properties as well as establish a metric of the subadiabaticity of cloud liquid water content profiles.

### ***John Sears***

M.S. Thesis title: "Investigating the Role of the Upper-Levels in Tropical Cyclogenesis." Recent studies on genesis have been primarily focused on the lower portions of the troposphere. Utilizing a unique satellite wind data set from a recent field study, this research focuses on the upper level dynamics behind tropical cyclogenesis and seeks to determine the role of the upper levels in facilitating lower level development.

### ***Mark Smalley***

M.S. Thesis title: "Effects of spectral response function uncertainties on cloud height retrievals using CO<sub>2</sub> slicing." The 30 year record of HIRS and MODIS cloud heights has the potential to create a true cirrus cloud climatology. However, inter-instrument biases in retrieved cloud heights due to differing spectral response functions must be addressed when assessing trends or cycles throughout the cloud height record. To estimate these biases in cloud heights retrieved with CO<sub>2</sub> slicing techniques, cloud heights for HIRS and MODIS instruments have been simulated using high spectral resolution measured radiances from AIRS.



***William Smith, Jr.***

Ph.D. Thesis title: "Using Satellite Data to Improve the Representation of Clouds and their Effects in Numerical Weather Analyses and Forecasts." New cloud products derived from CloudSat and CALIPSO data form the basis for a technique developed to retrieve the vertical distribution of cloud water from passive satellite observations. The technique is applied to GOES data over North America and adjacent oceans and the cloud products ingested into the NOAA Rapid Update Cycle (RUC) assimilation system. The impact of the satellite data on RUC model analyses and forecasts is assessed.

***Michelle Feltz, Undergraduate***

Paper Title: "Methodology for the Validation of Temperature Profiles from Hyperspectral Infrared Sounders Using GPS Radio Occultation: Experience with AIRS and COSMIC." This study is supported by JPSS EDR cal/val for the validation of CrIS/ATMS (CrIMSS) atmospheric vertical temperature profile (AVTP), a key requirement of the NOAA JPSS program. In preparation for the evaluation of the CrIMSS AVTP product, a methodology for comparison to GPS radio occultation profiles from the UCAR COSMIC processing center was developed using retrievals from the NASA Aqua AIRS sensor. The citation for a paper describing the methodology is given below. This study also has climate implications for detecting trends in upper tropospheric and stratospheric temperatures.



## **Appendix 6: Visitors at CIMSS 2012-2013 (visits of 3 days or more and key visitors)**

**Hyun Sung Jang**, Visiting Scientist, School of Earth and Environmental Sciences, Seoul National University, Republic of Korea  
**Jeffrey Harenza** and **Mitch Smith**, Griffin Financial Group, LLC  
**Jozsef Szamosfalvi**, Interlink Capital Strategies, LLC  
**Gene Pache**, GeoMetWatch  
**Yutaka Nagai**, **Eiji Sato**, **Osamu Sakurai**, **Kazuyuki Ito**, **Ken Shimotsuma**, and **Koichiro Matsufuji**, Sky Perfect JSAT Corporation  
**Tim Logue**, Thales Alenia Space North America  
**Julia He**, City College of New York  
**Stephen Brueske** (MKX MIC), **Jeff Craven** (MKX SOO), and **Mark Gehring** (MKX forecaster), NOAA NWS Milwaukee-Sullivan  
**Norio Kamekawa**, Japanese Meteorological Administration  
**Jie Zhang**, Visiting Scientist, Nanjing University of Information and Technology  
**Johannes Loschnigg**, White House Office of Science and Technology Policy  
**Tiziana Cherubini**, University of Hawaii's Department of Meteorology  
**Shane Hubbard**, University of Iowa  
**Katja Hungershofer**, Deutscher Wetterdienst (DWD), Germany  
**Wesley Terwey**, University of South Alabama's Meteorology Department  
**Augusto Brandão d' Oliveira**, CPTEC/INPE, Brazil  
**Wenguang Bai**, Visiting Scientist from National Satellite Meteorological Center, China Meteorological Administration  
**Louis W. Uccellini**, Director National Centers for Environmental Prediction  
**Barbara Arvani**, Università degli Studi di Modena e Reggio Emilia, Italy  
**Burcu Kabatas**, Istanbul Technical University, Eurasian Institute of Earth Science, Turkey  
**Regis Borde**, European Organisation for the Exploitation of Meteorological Satellites (EUMETSAT)  
**Christelle Ponsard** and **Anders Soerensen**, EUMETSAT  
**Andrzej Kotarba**, Space Research Centre of Polish Academy of Sciences  
**Roger Saunders**, Met Office, United Kingdom  
**Rodney Potts**, Centre for Australian Weather and Climate Research (CAWCR)  
**Jenny Baeseman**, Director of the World Climate Research Programme's (WCRP) Climate and Cryosphere (CliC) International Project Office and Founding Director of the Association of Polar Early Career Scientists (APECS), Tromsø, Norway  
**Waad Ibrahim**, Robert S. McNamara Fellow, World Bank, Technical University of Brandenburg in Cottbus, Germany  
**Greg Mandt**, GOES-R System Program Director  
**Shaima Nasiri**, Texas A&M  
**Steven Goodman**, GOES-R Senior Program Scientist  
**Kathryn Sullivan**, NOAA Chief Scientist, Assistant Secretary of Commerce for Environmental Observation and Prediction, and Deputy Administrator for NOAA  
**Candice McKechnie** and **Derek Van Dam**, E.TV Meteorologists, South Africa  
**Philip Frost**, CSIR Meraka Institute, South Africa  
**Mitch Goldberg**, Senior Scientist, and **Ajay Mehta**, Deputy Director, JPSS/NOAA  
**Dan Holdaway**, Global Modeling and Assimilation Office, NASA Goddard Space Flight Center  
**Jeff Hawkins**, Naval Research Laboratory, Monterey  
**Ed Zipser**, University of Utah  
**Clark Evans**, University of Wisconsin-Milwaukee



**David Barkai and Nathan Schumann**, Cray Computers  
**Kimberley Klockow**, University of Oklahoma  
**Chris Cox**, Geography Department, University of Idaho  
**Sung-Rae Chung and Eun-Jeong Cha**, NMSC/Korea Meteorological Administration  
**Jason Dunion**, NOAA/AOML/Hurricane Research Division, CIMAS/University of Miami  
**NWA Annual Meeting** – ~400 attendees



## **Appendix 7. CIMSS Subcontracts Summary**

PO 397K644 to University of Colorado Boulder. Payments made to them for the period of 4/1/2012- 3/31/2013 is \$39,534.03. NOAA Project title: GOES-R Calibration/Validation Field Campaign Support" Task title is "Ground Based Deployment of the Solar Spectral Flux Radiometer in Support of DC3", PI Sebastian Shmidt

PO 329K453 to Texas A&M. Payments made to them for the period of 4/1/2012 - 3/31/2013 is \$14,103.88, Project title: "Development of the optical properties soot, dust aerosols and ice crystals in support of the GOES-R research project of the Cooperative Institute for Meteorological Satellite Studies (CIMSS)", PI Dr. Ping Yang





## Appendix 8. CIMSS Peer Reviewed Publications: 2011-2012

### 2013 Accepted for Publication

Hoover, B.T.; Velden, C.S., and Majumdar, S.J. Physical mechanisms underlying selected adaptive sampling techniques for tropical cyclones. *Monthly Weather Review*, 2013, doi:10.1175/MWR-D-12-00269.1, accepted.

King, M.D.; Platnick, S.; Menzel, W.P.; Ackerman, S.A., and Hubanks, P.A. Spatial and temporal distribution of clouds observed by MODIS onboard the Terra and Aqua Satellites. *IEEE Transactions on Geoscience and Remote Sensing*, 2013, accepted.

Kolat, U.; Menzel, W.P.; Olson, E., and Frey, R.A. Very high cloud detection in more than two decades of HIRS data. *Journal of Geophysical Research-Atmospheres*, 2013, accepted.

Kunkel, K.E.; Karl, T.R.; Brooks, H.; Kossin, J.; Lawrimore, J.; Arndt, D.; Bosart, L.; Changnon, D.; Cutter, S.; Koesken, N.; Emanuel, K.; Groisman, P. Ya.; Katz, R.W.; Knutson, T.; O'Brien, J.; Paciorek, C.; Peterson, T.; Redmond, K.; Robinson, D.; Trapp, J.; Vose, R.; Weaver, S.; Wehner, M.; Wolter, K., and Wuebbles, D. Monitoring and understanding changes in extreme storm statistics: State of knowledge. *Bulletin of the American Meteorological Society*, 2013, in press.

Schreck, C.J. III; Shi, L.; Kossin, J.P., and Bates, J.J. Tropical intraseasonal variability in outgoing longwave radiation and upper tropospheric water vapor. *Journal of Climate*, 2013, in press.

Zwiers, F.W.; Alexander, G.C. Hegerl; Knutson, T.R.; Kossin, J.P.; Naveau, N. Nicholls; Schär; Seneviratne, S.I., and Zhang, X. World Climate Research Programme Open Science Conference Community Paper on Climate Extremes: Challenges in estimating and understanding recent changes in the frequency and intensity of extreme climate and weather events. Springer Monograph Series, 2013, in press.

### 2013 Reviewed Publications

Bennartz, R.; Shupe, M. D.; Turner, D. D.; Walden, V. P.; Steffen, K.; Cox, C. J.; Kulie, M. S.; Miller, N. B., and Pettersen, C. July 2012 Greenland melt extent enhanced by low-level liquid clouds. *Nature* v.496, no.7443, 2013, pp83-86.

Cole, Benjamin H.; Yang, Ping; Baum, Bryan A.; Piedi, Jerome; Labonnote, Laurent C.; Thieuleux, Francois, and Platnick, Steven. Comparison of PARASOL observations with polarized reflectances simulated using different ice habit mixtures. *Journal of Applied Meteorology and Climatology* v.52, no.1, 2013, pp186-196.

Ding, Shouguo; Yang, Ping; Baum, Bryan A.; Heidinger, Andrew, and Greenwald, Thomas. Development of a GOES-R Advanced Baseline Imager solar channel radiance simulator for ice clouds. *Journal of Applied Meteorology and Climatology*, v.52, no.4, 2013, pp872-888.

Foster, Michael J and Heidinger, Andrew. PATMOS-x: Results from a diurnally corrected 30-yr satellite cloud climatology. *Journal of Climate* v.26, no.2, 2013, pp414-425.



Hartung, D.C.; Sieglaff, J.M.; Cnonce, L.M., and Feltz, W.F. An inter-comparison of UW cloud-top cooling rates with WSR-88D radar data. *Weather and Forecasting* v.28, pp463-480, 2013.  
Hyer, Edward J.; Reid, Jeffrey S.; Prins, Elaine M.; Hoffman, Jay P.; Schmidt, Christospher C.; Meittinen, Jukka I., and Giglio, Louis. Patterns of fire activity over Indonesia and Malaysia from polar and geostationary satellite observations. *Atmospheric Research* v.122, no.2013, pp504-519.

Kabatas, B.; Menzel, W.P.; Bilgili, A., and Gumley, L.E. Comparing ship track droplet sizes inferred from Terra and Aqua MODIS data. *Journal of Applied Meteorology* v.52, no.1, pp230-241, 2013, doi:<http://dx.doi.org/10.1175/JAMC-D-11-0232.1>

Kataoka, F.; Knuteson, R.O.; Kuze, A.; Suto, H.; Shiomi, K.; Harada, M.; Garms, E.M.; Roman, J.A.; Tobin, D.C.; Taylor, J.K.; Revercomb, H.E.; Sekio, N.; Higuchi, R., and Mitomi, Y. TIR spectral radiance calibration of the GOSAT satellite borne TANSO-FTS with the aircraft-based S-HIS and the ground-based S-AERI at the Railroad Valley Desert Playa. *IEEE Transactions on Geoscience and Remote Sensing*, v., no.99, 2013, pp1-17, doi:10.1109/TGRS.2012.2236561.

Mielikainen, Jarno; Huang, Bormin; Wang, Jun; Huang, Hung-Lung Allen, and Goldberg, Mitchell D. Compute Unified Device Architecture (CUDA)-based parallelization of WRF Kessler cloud microphysics scheme. *Computers and Geosciences* v.52, no.2013, pp292-299.

Miller, N. B.; Turner, D. D.; Bennartz, R.; Shupe, M. D.; Kulie, M. S.; Cadeddu, M. P., and Walden, Von P. Surface-based inversions above central Greenland. *Journal of Geophysical Research* v.118, no.2013, ppdoi:10.1029/2012JD018867.

Pavolonis, Michael J.; Heidinger, Andrew K., and Sieglaff, Justin. Automated retrievals of volcanic ash and dust cloud properties from upwelling infrared measurements. *Journal of Geophysical Research* v.118, no.2013, doi:10.1002/jgrd.50173.

Qin, Sixian; Ma, Jianwen, and Wang, Xuanji. Development of a hierarchical Bayesian network algorithm for land surface data. *International Journal of Remote Sensing* v.34, no.6, 2013, pp1905-1927.

Shupe, Matthew D.; Turner, David D.; Walden, Von P.; Bennartz, Ralf; Cadeddu, Maria P.; Castellani, Benjamin B.; Cox, Christopher J.; Hudak, David R.; Kulie, Mark S.; Miller, Nathaniel B.; Neely, Ryan R. III; Neff, William D., and Rowe, Penny M. High and dry: New observations of tropospheric and cloud properties above the Greenland Ice Sheet. *Bulletin of the American Meteorological Society* v.94, no.2, 2013, pp169-186.

Sieglaff, Justin M.; Hartung, Daniel C.; Feltz, Wayne F.; Cnonce, Lee M., and Lakshmanan, Valliappa. A satellite-based convective cloud object tracking and multipurpose data fusion tool with application to developing convection. *Journal of Atmospheric and Oceanic Technology* v.30, no.3, 2013, pp510–525. Reprint #6952.

Smith, Nadia; Menzel, W. Paul; Weisz, Elisabeth; Heidinger, Andrew K., and Baum, Bryan A. A uniform space-time gridding algorithm for comparison of satellite data products: Characterization and sensitivity study. *Journal of Applied Meteorology and Climatology* v.52, no.1 , 2013, pp255-268.



Wang, Chenxi; Yang, Ping; Nasiri, Shaima L.; Platnick, Steven; Baum, Bryan A.; Heidinger, Andrew K., and Liu, Xu. A fast radiative transfer model for visible through shortwave infrared spectral reflectances in clear and cloudy atmospheres. *Journal of Quantitative Spectroscopy and Radiative Transfer* v.116, no.2013, pp122-131.

Wang, Chenxi; Yang, Ping; Platnick, Steven ; Heidinger, Andrew K.; Baum, Bryan A.; Greenwald, Thomas; Zhang, Zhibo, and Holz, Robert E. Retrieval of ice cloud properties from AIRS and MODIS observations based on a fast high-spectral-resolution radiative transfer model. *Journal of Applied Meteorology and Climatology* v.52, no.3, 2013, pp710-726.

Wielicki, B.A.; Young, D.F.; Mlynczak, M.G.; Thome, K.J.; Leroy, S.; Corliss, J.; Anderson, J.G.; Ao, C.O.; Bantges, R.; Best, F.; Bowman, K.; Brindley, H.; Butler, J.; Collins, W.; Dykema, J.A.; Doelling, D.R.; Feldman, D.R.; Fox, N.; Huang, X.; Holz, R.; Huang, Y.; Jin, Z.; Jennings, D.; Johnson, D.G.; Jucks, K.; Kato, S.; Kirk-Davidoff, D.B.; Knuteson, R.; Kopp, G.; Kratz, D.P.; Liu, X.; Lukashin, C.; Mannucci, A.J.; Phojanamongkolkij, N.; Pilewskie, P.; Ramaswamy, V.; Revercomb, H.; Rice, J.; Roberts, Y.; Roithmayr, C.M.; Rose, F.; Sandford, E.; Shirley, L.; Smith, S.L. Sr.; Soden, B.; Speth, P.W.; Sun, W.; Taylor, P.C.; Tobin, D., and Xiong, X. Achieving climate change absolute accuracy in orbit. *Bulletin of the American Meteorological Society*, 2013, Early Online Release, doi: <http://dx.doi.org/10.1175/BAMS-D-12-00149.1>.

Yang, Ping; Li, Lei; Baum, Bryan A.; Liou, Kuo-Nan; Kattawar, George W.; Mishchenko, Michael I., and Cole, Benjamin. Spectrally consistent scattering, absorption, and polarization properties of atmospheric ice crystals at wavelengths from 0.2 to 100 microns. *Journal of the Atmospheric Sciences* v.20, no.1, 2013, pp330-347.

Zhang, Yong and Gunshor, Mathew M. Intercalibration of FY-2C/D/E infrared channels using AIRS. *IEEE Transactions on Geoscience and Remote Sensing* v.51, no.3, 2013, pp1231-1244.

Zhao, Tom X. P.; Chan, Pui K., and Heidinger, Andrew K. A global survey of the effect of cloud contamination on the aerosol optical thickness and its long-term trend derived from operational AVHRR satellite observations. *Journal of Geophysical Research* v.118, no.2013, doi:10.1002/jgrd.50278.

### **2013 Non-reviewed Publications**

Gerth, Jordan; Cronce, Lee; Wade, Gary; Schmit, Tim; Craven, Jeff; Cooper, Diane, and Crowe, Christina. Madison, Wis., hosts 37th NWA Annual Meeting brings membership together. *National Weather Association Newsletter*, December, no.2013, pp3-4. Reprint #6948 .

Jung, Jim. Research enabled by the Center's new supercomputing facilities. *JCSDA Quarterly* v.42, no.2013, pp2-3. Reprint #6963.

### **2012 Reviewed Publications**

Bagley, Justin E.; Desai, Ankur R.; Dirmeyer, Paul A., and Foley, Jonathan A. Effects of land cover change on moisture availability and potential crop yields in the world's breadbaskets. *Environmental Research Letters* v.7, no.2012, doi:10.1088/1748-9326/7/1/-14009.



- Bassani, C.; Cavalli, R. M., and Antonelli, P. Influence of aerosol and surface reflectance variability on hyperspectral observed radiance. *Atmospheric Measurement Techniques* v.5, no.2012, pp1193-1203.
- Baum, Bryan A.; Menzel, W. Paul; Frey, Richard A.; Tobin, David C.; Holz, Robert E.; Ackerman, Steve A.; Heidinger, Andrew K., and Yang, Ping. MODIS cloud-top property refinements for Collection 6. *Journal of Applied Meteorology and Climatology* v.51, no.6, 2012, pp1145-1163.
- Bedka, Kristopher M.; Dworak, Richard; Brunner, Jason, and Feltz, Wayne. Validation of satellite-based objective overshooting cloud-top detection methods using CloudSat profiling radar observations. *Journal of Applied Meteorology and Climatology* v.51, no.10, 2012, pp1811-1822.
- Bikos, Dan; Lindsey, Daniel T.; Otkin, Jason; Sieglaff, Justin; Grasso, Louie; Siewert, Chris; Correia, James Jr.; Coniglio, Michael; Rabin, Robert; Kain, John S., and Dembek, Scott. Synthetic satellite imagery for real-time high-resolution model evaluation. *Weather and Forecasting* v.27, no.3, 2012, pp784–795.
- Bresky, Wayne C.; Daniels, Jaime M.; Bailey, Andrew A., and Wanzong, Steven T. New methods toward minimizing the slow speed bias associated with Atmospheric Motion Vectors. *Journal of Applied Meteorology and Climatology* v.51, no.12, 2012, pp2137-2151.
- Bucher, S. A.; Defor, E.; Evans, F.; Eliasson, S.; Mendrok, J.; Eriksson, P.; Lee, C.; Jimenez, C.; Prigent, C.; Crewell, S.; Kasai, Y.; Bennartz, R., and Gasiewski, A. J. Observing ice clouds in the submillimeter spectral range: The CloudIce mission proposal for ESA's Earth Explorer 8. *Atmospheric Measurement Techniques* v.5, no.7, 2012, pp1529-1549.
- Denlinger, Roger P.; Pavolonis, Mike, and Sieglaff, Justin. A robust method to forecast volcanic ash clouds. *Journal of Geophysical Research* v.117, no.2012, doi:10.1029/2012JD017732. .
- Di Michele, Sabatino; Ahlgrimm, Maike; Forbes, Richard; Kulie, Mark; Bennartz, Ralf; Janiskova, Marta, and Bauer, Peter. Interpreting an evaluation of the ECMWF global model with CloudSat observations: Ambiguities due to radar reflectivity forward operator uncertainties. *Quarterly Journal of Royal Meteorological Society* v.138, no.669, 2012, pp2047-2065.
- Duan, Hao; Fang, Yong, and Huang, Bormin. Parallel design of JPEG-LS encoder on graphics processing units. *Journal of Applied Remote Sensing* v.6, no.2012, doi:10.1117/1.JRS.6.061508.
- Dupont, R.; Pierce, B.; Worden, J.; Hair, J.; Fenn, M.; Hamer, P.; Natarajan, M.; Schaack, T.; Lenzen, A.; Apel, E.; Dibb, J.; Diskin, G.; Huey, G.; Weinheimer, A.; Kondo, Y., and Knapp, D. Attribution and evolution of ozone from Asian wild fires using satellite and aircraft measurements during the ARCTAS campaign. *Atmospheric Chemistry and Physics* v.12, no.1, 2012, pp169-188.
- Dworak, Richard; Bedka, Kristopher; Brunner, Jason, and Feltz, Wayne. Comparison between GOES-12 overshooting-top detections, WSR-88D radar reflectivity, and severe storm reports. *Weather and Forecasting* v.27, no.3, 2012, pp684–699.
- Emanuel, Kerry; Fondriest, Fabian, and Kossin, James. Potential economic value of seasonal hurricane forecasts. *Weather, Climate, and Society* v.4, no.2, 2012, pp110-117.



Evan, Amato T.; Kossin, James P.; Chang, Chul Eddy, and Ramanathan, V. Reply to: Intensified Arabian Sea tropical storms. Brief communication arising from: Arabian Sea tropical cyclones intensified by emissions of black carbon and other aerosols. *Nature* v.489, no.7416, 2012, ppE2-E3.

Evans, Clark; Archambault, Heather M.; Cordeira, Jason M.; Fritz, Cody; Galarneau, Thomas J. Jr.; Gjorgjievska, Saska; Griffin, Kyle S.; Johnson, Alexandria; Komaromi, William A.; Monette, Sarah; Muradyan, Paytsar; Murphy, Brian; Riemer, Michael; Sears, John; Stern, Daniel; Tang, Brian, and Thompson, Segayle. The Pre-Depression Investigation of Cloud-systems in the Tropics (PREDICT) field campaign: Perspectives of early career scientists. *Bulletin of the American Meteorological Society* v.93, no.2, 2012, pp173-187.

Fast, J. D.; Fustafson, W. I.; Berg, L. K.; Shaw, W. J.; Pekour, M.; Shrivastava; Barnard, J. C.; Ferrare, R. A.; Hostetler, C. A.; Hair, J. A.; Erickson, M.; Jobson, B. T.; Flowers, B.; Dubey, M. K.; Springston, S.; Pierce, R. B.; Dolislager, L.; Pederson, J., and Zaveri, R. A. Transport and mixing patterns over Central California during the Carbonaceous Aerosol and Radiative Effects Study (CARES). *Atmospheric Chemistry and Physics* v.12, no.4, 2012, pp1759-1783.

Foster, M. J.; Ackerman, S. A.; Heidinger, A. K., and Maddux, B. C. State of the climate in 2011: Cloudiness. *Bulletin of the American Meteorological Society* v.93, no.7, 2012, ppS27-S28.

Goodman, Steven J.; Gurka, James; DeMaria, Mark; Schmit, Timothy J.; Mostek, Anthony; Jedlovec, Gary; Siewert, Chris; Feltz, Wayne; Gerth, Jordan; Brummer, Renate; Miller, Steven; Reed, Connie, and Reynolds, Richard R. The GOES-R Proving Ground: Accelerating user readiness for the next-generation geostationary environmental satellite system. *Bulletin of the American Meteorological Society* v.93, no.7, 2012, pp1029–1040.

Han, Hyo-Jin; Sohn, Byung-Ju; Huang, Hung-Lung; Weisz, Elisabeth; Saunders, Roger, and Takamura, Tamio. An improved radiance simulation for hyperspectral infrared remote sensing of Asian dust. *Journal of Geophysical Research* v.117, no.2012, doi:10.1029/2012JD017466.

Heidinger, Andrew K.; Evan, Amato T.; Foster, Michael J., and Walther, Andi. A naive Bayesian cloud-detection scheme derived from CALIPSO and applied within PATMOS-x. *Journal of Applied Meteorology and Climatology* v.51, no.6, 2012, pp1129–1144.

Hilton, Fiona; Armante, Raymond; August, Thomas; Barnett, Chris; Bouchard, Aurelie; Camy-Peyret, Claude; Capelle, Virginie; Clarisse, Lieven; Clerbaux, Cathy; Coheur, Pierre-Francois; Collard, Andrew; Crevoisier, Cyril; Dufour, Gaele; Edwards, David; Faijan, Francois; Fourrie, Nadia; Gambacorta, Antonia; Goldberg, Mitchell; Guidard, Vincent; Hurtmans, Daniel; Illingworth, Samuel; Jacquinet-Husson, Nicole; Kerzenmacher, Tobias; Klaes, Dieter; Lavanant, Lydie; Masiello, Guido; Matricardi, Marco; McNally, Anthony; Newman, Stuart; Pavelin, Edward; Payan, Sebastien; Pequignot, Eric; Peyridieu, Sophie; Phulpin, Thierry; Remedios, John; Schlüssel, Peter; Serio, Carmine; Strow, Larrabee; Stubenrauch, Claudia; Taylor, Jonathan; Tobin, David; Wolf, Walter, and Zhou, Daniel. Hyperspectral Earth observation from IASI: Five years of accomplishments. *Bulletin of the American Meteorological Society* v.93, no.3, 2012, pp347-370.



Hsieh, Tung-Ju; Chang, Yang-Lang, and Huang, Bormin. High-performance visual analytics of terrestrial light detection and ranging data on large display wall. *Journal of Applied Remote Sensing* v.6, no.2012,.

Hsieh, Tung-Ju; Chang, Yang-Lang, and Huang, Bormin. High-performance visual analytics of terrestrial light detection and ranging data on large display wall. *Journal of Applied Remote Sensing* v.6, no.2012, doi:10.1117/1.JRS.6.061502.

Hsieh, Tung-Ju; Lee, Shiann-Jung; Yang, Yuan-Sen; Chang, Yang-Lang; Huang, Bormin; Chen, Cheng-Kai, and Ma, Kwan-Liu . High-performance computing and visualization of earthquake simulations and ground-motion sensor network data. *Journal of Applied Remote Sensing* v.6, no.2012.

Huang, Min; Carmichael, Gregory R.; Kulkarni, Sarika; Streets, David G.; Lu, Zifeng; Zhang, Qiang; Pierce, R. Bradley; Kondo, Yutaka; Jimenez, Jose L.; Cubison, Michael J.; Anderson, Bruce, and Wisthaler, Armin. Sectoral and geographical contributions to summertime Continental United States (CONUS) black carbon spatial distributions. *Atmospheric Environment* v.51, no.2012, pp165-174.

Koltunov, Alexander; Ustin, Susan L., and Prins, Elaine M. On timeliness and accuracy of wildfire detection by the GOES WF-ABBA algorithm over California during the 2006 fire season. *Remote Sensing of Environment* v.127, no.2012, pp194-209.

Kossin, James P. and Sitkowski, Matthew. Predicting hurricane intensity and structure changes associated with eyewall replacement cycles. *Weather and Forecasting* v.27, no.2, 2012, pp484-488.

Kozar, Michael E.; Mann, Michael E.; Camargo, Suzana J.; Kossin, James P., and Evans, Jenni L. Stratified statistical models of North Atlantic basin-wide and regional tropical cyclone counts. *Journal of Geophysical Research* v.117, no.2012, doi:10.1029/2011JD017170.

Kwon, Eun-Han; Li, Jun; Li, Jinlong; Bohn, B. J., and Weisz, Elisabeth. Use of total precipitable water classification of a priori error and quality control in atmospheric temperature and water vapor sounding retrieval. *Advances in Atmospheric Sciences* v.29, no.2, 2012, pp263-273.

Kwon, Eun-Han; Sohn, B. J.; Smith, William L., and Li, Jun. Validating IASI temperature and moisture sounding retrievals over East Asia using radiosonde observations. *Journal of Atmospheric and Oceanic Technology* v.29, no.9, 2012, pp1250–1262.

Lakshimanan, Valliappa; Rabin, Robert; Otkin, Jason; Kain, John S., and Dembek, Scott. Visualizing Model Data Using a Fast Approximation of a Radiative Transfer Model. *Journal of Atmospheric and Oceanic Technology* v.29, no.5, 2012, pp745–754.

Li, Jun; Liu, Chian-Yi; Zhang, Peng, and Schmit, Timothy J. Applications of full spatial resolution space-based advanced infrared soundings in the preconvective environment. *Weather and Forecasting* v.27, no.2, 2012, pp515-524.

Li, Zhenglong; Li, Jun; Li, Yue; Schmit, Timothy J.; Zhou, Lihang; Goldberg, Mitchell D., and Menzel, W. Paul. Determining diurnal variations of land surface emissivity from geostationary satellites. *Journal of Geophysical Research* v.117, no.2012, doi:10.1029/2012JD018279.



Lindsey, Daniel T.; Schmit, Timothy J.; MacKenzie, Wayne M. Jr.; Jewett, Christopher P.; Gunshor, Mat M., and Grasso, Louie. 10.35 micron: Atmospheric window on the GOES-R Advanced Baseline imager with less moisture attenuation. *Journal of Applied Remote Sensing* v.6, no.2012, doi:10.1117/1.JRS.6.063598.

Lindstrot, R.; Preusker, R.; Diedrich, H.; Doppler, L.; Bennartz, R., and Fischer, J. ID-Var retrieval of daytime total columnar water vapour from MERIS measurements. *Atmospheric Measurement Techniques* v.5, no.2012, pp631-646.

Liu, Yinghui; Key, Jeffrey R.; Ackerman, Steven A.; Mace, Gerald G., and Zhang, Qiuqing. Arctic cloud macrophysical characteristics from CloudSat and CALIPSO. *Remote Sensing of Environment* v.124, no.2012, pp159-173.

Liu, Yinghui; Key, Jeffrey R.; Liu, Zhengyu; Wang, Xuanji, and Vavrus, Stephen S. A cloudier Arctic expected with diminishing sea ice. *Geophysical Research Letters* v.39, no.2012, doi:10.1029/2012GL051251.

McBride, P. J.; Schmidt, K. S.; Pilewskie, P.; Walther, A.; Heidinger, A. K.; Wolfe, D. E.; Fairall, C. W., and Lance, S. CalNex cloud properties retrieved from a ship-based spectrometer and comparisons with satellite and aircraft retrieved cloud properties. *Journal of Geophysical Research* v.117, no.2012, doi:10.1029/2012JD017624.

Mielikainen, Jarno, and Huang, Bormin. Lossless compression of hyperspectral images using clustered linear prediction with adaptive prediction length. *IEEE Geoscience and Remote Sensing Letters*, v.9, no.6, 2012, pp1118-1121.

Mielikainen, Jarno; Huang, Bormin; Huang, Hung-Long Allen, and Goldberg, Mitchell D. Improved GPU/CUDA based parallel Weather and Research Forecast (WRF) Single Moment 5-class (WSM5) cloud microphysics. *IEEE Journal of Selected Topics in Applied Earth Observations and Remote Sensing* v.5, no.4, 2012, pp1256-1265.

Mielikainen, Jarno; Huang, Bormin; Huang, Hung-Lung Allen, and Goldberg, Mitchell D. GPU acceleration of the updated Goddard shortwave radiation scheme in the Weather Research and Forecasting (WRF) model. *IEEE Journal of Selected Topics in Applied Earth Observations and Remote Sensing* v.5, no.2, 2012, pp555-562.

Mielikainen, Jarno; Huang, Bormin; Huang, Hung-Lung Allen, and Goldberg, Mitchell D. GPU implementation of Stony Brook University 5-class cloud microphysics scheme in the WRF. *IEEE Journal of Selected Topics in Applied Earth Observations and Remote Sensing* v.5, no.2, 2012, pp625-633.

Miller, Steven D.; Schmidt, Christopher C.; Schmit, Timothy J., and Hillger, Donald W. A case for natural colour imagery from geostationary satellites, and an approximation for the GOES-R ABI. *International Journal of Remote Sensing* v.33, no.13, 2012, pp3999-4028.

Mlawer, E.J.; Payne, V.H.; moncet, J.; Delamere, J.S.; Alvarado, M.J., and tobin, D.C. Development and recent evaluation of the MT\_CKD model of continuum absorption. *Philosophical Transactions of The Royal Society A*, v.370, 2012, doi:10.1098/rsta.2011.0295.

Monette, Sarah A.; Velden, Christopher S.; Griffin, Kyle S., and Rozoff, Christopher M. Examining trends in satellite-detected tropical overshooting tops as a potential predictor of



tropical cyclone rapid intensification. *Journal of Applied Meteorological and Climatology* v.51, no.11, 2012, pp1917-1930.

Montgomery, Michael T.; Davis, Christopher; Dunkerton, Timothy; Wang, Zhou; Velden, Christopher; Torn, Ryan; Majumdar, Sharanya J.; Zhang, Fuqing; Smith, Roger K.; Bosart, Lance; Bell, Michael M.; Haase, Jennifer S.; Heymsfield, Andrew; Jensen, Jorgen; Campos, Teresa, and Boothe, Mark A. The Pre-Depression Investigation of Cloud-systems in the Tropics (PREDICT) experiment: Scientific basis, new analysis tools, and some first results. *Bulletin of the American Meteorological Society* v.93, no.2, 2012, pp153-172.

Mooney, Margaret E.; Ackerman, Steve; McKinley, Galen A.; Whittaker, Tom, and Jasmin, Tommy. Lesson plans and classroom activities from the Climate Literacy Ambassadors Community. *The Earth Scientist* v.28, no.3, 2012, pp30-32.

Natarajan, Murali; Pierce, R. Bradley; Schaack, Todd K.; Lenzen, Allen J.; Al-Saadi, Jassim A.; Soja, Amber J.; Charlock, Thams P.; Rose, Fred G.; Winker, David M., and Worden, John R. Radiative forcing due to enhancements in tropospheric ozone and carbonaceous aerosols caused by Asian fires during spring 2008. *Journal of Geophysical Research* v.117, no.2012, doi:10.1029/2011JD016584.

Newman, Stuart M.; Larar, Allen M.; Smith, William L.; Ptashnik, Igor V.; Jones, Roderic L.; Mead, Mohammed I.; Revercomb, Henry; Tobin, David C.; Taylor, Joe K., and Taylor, Jonathan P. The Joint Airborne IASI Validation Experiment: An evaluation of instrument and algorithms. *Journal of Quantitative Spectroscopy and Radiative Transfer* v.113, no.11, 2012, pp1372-1390.

Otkin, Jason A. Assessing the impact of the covariance localization radius when assimilating infrared brightness temperature observations using an Ensemble Kalman Filter. *Monthly Weather Review* v.140, no.2, 2012, pp543-561.

Otkin, Jason A. Assimilation of water vapor sensitive infrared brightness temperature observations during a high impact weather event. *Journal of Geophysical Research* v.117, no.2012, doi:10.1029/2012JD017568.

Overland, J.; Bhatt, U.; Key, J.; Liu, Y.; Walsh, J., and Wang, M. State of the climate in 2011: Air temperature, atmospheric circulation, and clouds. *Bulletin of the American Meteorological Society* v.93, no.7, 2012, ppS127-S129.

Peduzzi, P.; Chatenoux, B.; Dao, H.; De Bono, A.; Herold, C.; Kossin, J.; Mouton, F., and Nordbeck, O. Global trends in tropical cyclone risk. *Nature Climate Change* v.2, no.2012, pp289-294.

Pincus, Robert; Platnick, Steven; Ackerman, Steven A.; Hemler, Richard S., and Hofmann, Robert J. Patrick. Reconciling simulated and observed views of clouds: MODIS, ISCCP, and the limits of instrument simulations. *Journal of Climate* v.25, no.13, 2012, pp4699-4720.

Remer, L. A.; Mattoo, S.; Levy, R. C.; Heidinger, A.; Pierce, R. B., and Chin, M. Retrieving aerosol in a cloudy environment: Aerosol product availability as a function of spatial resolution. *Atmospheric Measurement Techniques* v.5, no.2012, pp1823-1840.

Roman, Jacola A.; Knuteson, Robert O.; Ackerman, Steven A.; Tobin, David C., and Revercomb, Henry E. Assessment of regional global climate model water vapor bias and trends using





Precipitable Water Vapor (PWV) observations from a network of Global Positioning Satellite (GPS) receivers in the US Great Plains and Midwest. *Journal of Climate* v.25, no.16, 2012, pp5471–5493.

Rozoff, Christopher M.; Nolan, David S.; Kossin, James P.; Zhang, Fuqing, and Fang, Juan. The roles of an expanding wind field and inertial stability in tropical cyclone secondary eyewall formation. *Journal of the Atmospheric Sciences* v.69, no.9, 2012, pp2621–2643.

Satria, Muhammad T.; Huang, Bormin; Hsieh Tung-Ju; Chang, Yang-Lang, and Liang, Wen-Yew. GPU acceleration of tsunami propagation model. *IEEE Journal of Selected Topics in Applied Earth Observations and Remote Sensing* v.5, no.3, 2012, pp1014-1023.

Sears, John and Velden, Christopher S. Validation of satellite-derived Atmospheric Motion Vectors and analyses around tropical disturbances. *Journal of Applied Meteorology and Climatology* v.51, no.10, 2012, pp1823-1834.

Seneviratne, S.I.; Nicholls, N.; Easterling, D.; Goodess, C.M.; Kanae, S.; Kossin, J.; Luo, Y.; Marengo, J.; McInnes, K.; Rahimi, M.; Reichstein, M.; Sorteberg, A.; Vera, C., and Zhang, X. Changes in climate extremes and their impacts on the natural physical environment. In: *Managing the risks of Extreme Events and Disasters to Advance Climate change Adaptation* [Field, C.B.; Barros, V.; Stocker, T.F.; Qin, D.; Dokken, D.J.; Ebi, K.L.; Mastrandrea, M.D.; Mach, K.J.; Plattner, G.-K.; Allen, S.K.; Tignor, M., and Midgley, P.M. (eds.)]. A Special Report of Working Groups I and II of the Intergovernmental Panel on Climate Change (IPCC). Cambridge, UK; New York, Cambridge University Press, 2012, pp109-230.

Sitkowski, Matthew; Kossin, James P.; Rozoff, Christopher M., and Knaff, John A. Hurricane eyewall replacement cycle thermodynamics and the relict inner eyewall circulation. *Monthly Weather Review* v.140, no.12, 2012, pp4035-3045.

Smith, William L. Sr.; Weisz, Elisabeth; Kireev, Stanislav V.; Zhou, Daniel K.; Li, Zhenglong, and Borbas, Eva E. Dual-regression retrieval algorithm for real-time processing of satellite ultraspectral radiances. *Journal of Applied Meteorology and Climatology* v.51, no.8, 2012, pp1455–1476.

Song, Juan; Li, Yunsong; Wang, Keyan; Wu, Chengke, and Huang, Bormin. Distributed video coding with progressive correlation noise refinement and maximum likelihood pre-decoding. *Optical Engineering* v.51, no.7, 2012, Paper 077401.

Turner, D. D.; Mlawer, E. J.; Bianchini, G.; Cadetdu, M. P.; Crewell, S.; Delamere, J. S.; Knuteson, R. O.; Maschwitz, G.; Mlynzcak, M.; Paine, S.; Palchetti, L., and Tobin, D. C. Ground-based high spectral resolution observations of the entire terrestrial spectrum under extremely dry conditions. *Geophysical Research Letters* v.39, no.2012, doi:10.1029/2012GL051542.

Turner, David D.; Gero, P. Jonathan, and Tobin, David C. The far-infrared: Focusing on a relatively underexplored portion of the electromagnetic spectrum. *Bulletin of the American Meteorological Society* v.93, no.11, 2012, ppES103–ES104.

van Dienenhoven, B.; Cairns, B.; Geogdzhayev, I. V.; Fridling, A. M.; Ackerman, S.A.; Yang, P., and Baum, B. A. Remote sensing of ice crystal asymmetry parameter using multi-directional



polarization measurement - part 1: Methodology and evaluation with simulated measurements. *Atmospheric Measurement Techniques* v.5, no.2012, pp2361-2374.

Walther, Andi and Heidinger, Andrew K. Implementation of the Daytime Cloud Optical and Microphysical Properties algorithm (DCOMP) in PATMOS-x. *Journal of Applied Meteorology and Climatology* v.51, no.7, 2012, pp1371–1390.

Wang, Chenxi; Ding, Shouguo; Yang, Ping; Baum, Bryan, and Dessler, Andrew E. A new method to retrieving cirrus cloud height with a combination of MODIS 1.24- and 1.38-micron channels. *Geophysical Research Letters* v.39, no.2012, doi:10.1029/2012GL053854.

Wang, Xuanji; Key, Jeffrey; Liu, Yinghui; Fowler, Charles; Maslanik, James, and Tschudi, Mark. Arctic climate variability and trends from satellite observations. *Advances in Meteorology* v.2012, 2012, 22p, doi:10.1155/2012/505613.

Webley, P. W.; Steensen, T.; Stuefer, M.; Grell, G.; Freitas, S., and Pavolonis, M. Analyzing the Eyjafjallajökull 2010 eruption using satellite remote sensing, lidar and WRF-Chem dispersion and tracking model. *Journal of Geophysical Research* v.117, no.2012, doi:10.1029/2011JD016817.

Weisz, Elisabeth; Menzel, W. Paul; Smith, Nadia; Frey, Richard; Borbas, Eva E., and Baum, Bryan A. An approach for improving cirrus cloud-top pressure/height estimation by merging high-spatial-resolution infrared-window imager data with high-spectral-resolution sounder data. *Journal of Applied Meteorology and Climatology* v.51, no.8, 2012, pp1477–1488.

Yao, Z.; Li, J.; Han, H.-J.; Huang, A.; Sohn, B.J., and Zheng, P. Asian dust height and infrared optical depth retrievals over land from hyperspectral longwave infrared radiances. *Journal of Geophysical Research-Atmospheres*, v.117, D19202, 2012, doi:10.1029/2012JD017799.

Yao, Zhigang; Li, Jun, and Li, Jinlong. Sun glint impact on atmospheric soundings from hyperspectral resolution infrared radiances. *Advances in Atmospheric Sciences* v.29, no.3, 2012, pp455-463.

Zhang, Xiaoyang; Kondragunta, Shobha; Ram, Jessica; Schmidt, Christopher, and Hung, Ho-Chun. Near-real-time global biomass burning emissions product from geostationary satellite constellation. *Journal of Geophysical Research* v.117, no.2012, doi:10.1029/2012JD017459.

Zhang, Yang; Karamchandani, Prakash; Glotfelty, Timothy; Streets, David G.; Grell, Georg; Nenes, Athanasios; Yu, Fangqun, and Bennartz, Ralf. Development and initial application of the global-through-urban weather research and forecasting model with chemistry (GU-WRF/Chem). *Journal of Geophysical Research* v.117, no.2012, doi:10.1029/2012JD017966.

Zhou, Chen; Yang, Ping; Dessler, Andrew E. ; Hu, Youngxiang, and Baum, Bryan A. Study of horizontally oriented ice crystals with CALIPSO observations and comparison with Monte Carlo radiative transfer simulations. *Journal of Applied Meteorology and Climatology* v.51, no.7, 2012, pp1426-1439.



## **2012 Non-reviewed Publications**

English, Stephen and Huang, Allen. A short report from the 18th International TOVS Study Conference. JCSDA Quarterly v.38, no.2012, pp2-3.

Hoover, Brett and Santek, David. Polar winds and forecast busts. JCSDA Quarterly v.41, no.2012, pp1-2.

Li, Jun; Li, Jinlong; Zheng, Jin, and Schmit, Tim. Improving tropical cyclone forecasts with water vapor and temperature information from satellites. JCSDA Quarterly v.38, no.2012, pp1-2.

Schmit, Tim. The ABI on GOES-R. National Weather Association Newsletter v.April, no.2012, p4.



## **Appendix 9. CIMSS Conference Papers and Presentations: 2011-2012**

### **2013**

Ackerman, Steve. On-line and mobile learning activities. Symposium on Education, 22nd, Austin, TX, 6-10 January 2013. Boston, MA, American Meteorological Society, 2013.

Anderson, Martha C.; Hain, C.; Otkin, J. A., and Zhan, X. Evaluation of a remotely sensed Evaporative Stress Index for monitoring patterns of anomalous water use. Conference on Hydrology, 27th, Austin, TX, 6-10 January 2013. Boston, MA, American Meteorological Society, 2013.

Boukabara, Sid Ahmed; Riishojgaard, L. P.; Yoe, J. G.; Devaliere, E. M.; Pratt, A.; Garrett, K. J.; Jung, J. A.; Nolin, S., and Sinno, S. S4 and JIBB: Building the infrastructure for an effective O2R and a streamlined R2O. Special Symposium on the Joint Center for Satellite Data Assimilation, Austin, TX, 6-10 January 2013. Boston, MA, American Meteorological Society, 2013.

Bright, David; Levit, J. J.; Harless, A. R.; Maxson, B.; Strahan, M.; Lack, S. A.; Schwedler, B. R. J., and Terborg, A. Research to operations within the NOAA Aviation Weather Testbed (AWT). Conference on Transition of Research to Operations, 3rd, Austin, TX, 6-10 January 2013. Boston, MA, American Meteorological Society, 2013.

Brunner, Jason C.; Pierce, B.; Lenzen, A., and Szykman, J. GOES-R AWG visibility and the visibility-fires analysis over western United States for 2007-2008. Annual Symposium on Future Operational Environmental Satellite Systems, 9th, Austin, TX, 6-10 January 2013. Boston, MA, American Meteorological Society, 2013.

Brunner, Jason C.; Schmidt, C. C.; Prins, E. M.; Hoffman, J. P.; Schroeder, W., and Csiszar, I. A. Western Hemisphere diurnal fire activity 1995-2012: Description and initial fire trend analysis of the GOES-East version 6.5 WF\_ABBA data archive. Conference on Applied Climatology, 20th, Austin, TX, 6-10 January 2013. Boston, MA, American Meteorological Society, 2013.

Daniels, Jaime; Bresky, W.; Wanzong, S., and Velden, C. Atmospheric Motion Vectors derived via a new nested tracking algorithm developed for the GOES-R Advanced Baseline Imager (ABI). Annual Symposium on Future Operational Environmental Satellite Systems, 9th, Austin, TX, 6-10 January 2013. Boston, MA, American Meteorological Society, 2013.

DeSlover, Daniel; Tobin, D.; Revercomb, H.; Taylor, J.; Knuteson, R., and Borg, L. The Cross-track Infrared Sounder (CrIS) on Suomi NPP: Quality assurance study. Annual Symposium on Future Operational Environmental Satellite Systems, 9th, Austin, TX, 6-10 January 2013. Boston, MA, American Meteorological Society, 2013.

Eloranta, Edwin W.; Garcia, J. P., and Garcia, R. A web based portal for integrated real time access to multiple data streams. Conference on Environmental Information Processing Technologies, 29th, formerly IIPS, Austin, TX, 6-10 January 2013. Boston, MA, American Meteorological Society, 2013.



Feltz, Joleen M.; Feltz, M.; Garms, E.; Bah, K., and Knuteson, R. Visualizing geostationary and polar orbiting satellite weather products in McIDAS-V. Conference on Environmental Information Processing Technologies, 29th, formerly IIPS, Austin, TX, 6-10 January 2013. Boston, MA, American Meteorological Society, 2013.

Feltz, Michelle; Knuteson, R. O.; Revercomb, H.; Tobin, D., and Ackerman, S. Validation of temperature profile environmental data records (EDRs) from the Cross-track Infrared Microwave Sounding Suite (CrIMSS) using COSMIC dry temperature profiles. Annual Symposium on Future Operational Environmental Satellite Systems, 9th, Austin, TX, 6-10 January 2013. Boston, MA, American Meteorological Society, 2013.

Feltz, Wayne F.; Carey, L.; Bedka, K.; Rogers, R. H.; Monette, S. A., and Fleeger, C. Integrated GOES-R GLM/ABI approaches for the detection and forecasting of convectively induced turbulence. Conference on Aviation, Range, and Aerospace Meteorology, 16th, Austin, TX, 6-10 January 2013. Boston, MA, American Meteorological Society, 2013.

Garms, Elise M.; Knuteson, R.; Plokhenko, Y.; Revercomb, H., and Ackerman, S. A. Use of hyperspectral infrared analysis products in tropical cyclone intensity monitoring and near-term trending. Special Symposium on the Next Level of Predictions in Tropical Meteorology: Techniques, Usage, Support, and Impacts, Austin, TX, 6-10 January 2013. Boston, MA, American Meteorological Society, 2013.

Gerth, Jordan J. The ingredients for sustaining success in NOAA R2O for GOES-R. Annual Symposium on Future Operational Environmental Satellite Systems, 9th, Austin, TX, 6-10 January 2013. Boston, MA, American Meteorological Society, 2013.

Gladkova, Irina; Cross, J. III; Menzel, P.; Heidinger, A., and Grossberg, M. Statistical reconstruction of a 13.3 micron channel for VIIRS using multisensor data fusion with application to cloud-top pressure estimation. Conference on Environmental Information Processing Systems, 29th, formerly IIPS, Austin, TX, 6-10 January 2013. Boston, MA, American Meteorological Society, 2013.

Gravelle, Chad M. and Terborg, A. The GOES-R Proving Ground 2012 aviation weather testbed summer experiment - case studies. Conference on Aviation, Range, and Aerospace Meteorology, 16th, Austin, TX, 6-10 January 2013. Boston, MA, American Meteorological Society, 2013.

Greenwald, Tom; Davies, J. E., and Bennartz, R. Optimizing radiative transfer calculations in the CRTM for clouds, precipitation and aerosols. Special Symposium on the Joint Center for Satellite Data Assimilation, Austin, TX, 6-10 January 2013. Boston, MA, American Meteorological Society, 2013.

Greenwald, Tom; Pierce, B.; Otkin, J.; Schaack, T.; Davies, J.; Borbas, E.; Rogal, M.; Sieglaff, J., and Huang, H. L. Near-real-time simulated ABI imagery for user readiness, retrieval algorithm evaluation and model verification. Annual Symposium on Future Operational Environmental Satellite Systems, 9th, Austin, TX, 6-10 January 2013. Boston, MA, American Meteorological Society, 2013.

Gultepe, Ismaili; Kuhn, T.; Pavolonis, M. J.; Calvert, C. G.; Gurka, J.; Ware, R., and Vukovic, Z. R. Ice fog (pogonip) and frost in Arctic: Application to aviation. Conference on Aviation, Range, and Aerospace Meteorology, 16th, Austin, TX, 6-10 January 2013. Boston, MA, American Meteorological Society, 2013.



Gurka, James J.; Goodman, S. J.; Schmit, T. J.; DeMaria, M.; Mostek, A.; Motta, B. C.; Stewert, C. W.; Reed, B., and Folmer, M. J. The GOES-R Proving Ground: Results from the 2012 demonstrations and future plans. Annual Symposium on Future Operational Environmental Satellite Systems, 9th, Austin, TX, 6-10 January 2013. Boston, MA, American Meteorological Society, 2013.

Harless, Amy R.; Levit, J. J.; Schwedler, B. R. J.; Terborg, A.; Gravelle, C. M.; Murphy, M. P.; Entwistle, B.; Vietor, D.; Bright, D. R., and Hinson, L. The 2012 Aviation Weather Testbed summer experiment: An evaluation of next-generation numerical model guidance and aviation forecasting. Conference on Aviation, Range, and Aerospace Meteorology, 16th, Austin, TX, 6-10 January 2013. Boston, MA, American Meteorological Society, 2013.

Holz, Robert E.; Nagle, F. W.; Quinn, G.; Sun, H.; Kuehn, R., and Wolf, W. W. A processing and validation system to collocate GOES-R and JPSS products to support combined GEO/LEO product development and validation activities using advanced physical collocation techniques. Annual Symposium on Future Operational Environmental Satellite Systems, 9th, Austin, TX, 6-10 January 2013. Boston, MA, American Meteorological Society, 2013.

Huang, Allen; Huang, B., and Mielikainen, J. The development of GPU-based high-performance models in support of real time weather and environmental applications. Conference on Integrated Observing and Assimilation Systems for the Atmosphere, Oceans, and Land Surface, 17th, IOAS-AOLS, Austin, TX, 6-10 January 2013. Boston, MA, American Meteorological Society, 2013.

Huang, Jingfeng; Laszlo, I.; Kondragunta, S.; Liu, H.; Cronk, H.; Huang, H. C.; Remer, L.; Jackson, S.; Hsu, C.; Sayer, A. M.; Oo, M.; Holz, R. E.; Hyer, E. J.; Munchak, L.; Levy, R.; Mattoo, S.; Petrenko, M., and Ichoku, C. Validation of the NPP/VIIRS operational aerosol products through multi-sensor intercomparisons. Annual Symposium on Future Operational Environmental Satellite Systems, 9th, Austin, TX, 6-10 January 2013. Boston, MA, American Meteorological Society, 2013.

Jones, Thomas A.; Otkin, J. A.; Stensrud, D. J., and Knopfmeier, K. H. Assimilating simulated radar and satellite data using an OSSE experiment from 24 December 2009. Annual Symposium on Future Operational Environmental Satellite Systems, 9th, Austin, TX, 6-10 January 2013. Boston, MA, American Meteorological Society, 2013.

Jung, James A. and Riishojgaard, L. P. Observing system experiment impacts from conventional and satellite data using the NCEP Global Data Assimilation System. Special Symposium on the Joint Center for Satellite Data Assimilation, Austin, TX, 6-10 January 2013. Boston, MA, American Meteorological Society, 2013.

Lee, Thomas F.; Kuciauskas, A. P.; Dills, P.; Gerth, J. J.; Gravelle, C. M.; Bachmeier, S.; Gurka, J.; Mostek, A.; Schmit, T. J.; McWilliams, G., and Furgerson, J. Preparing user communities for the next generation of LEO and GEO environmental satellites. Annual Symposium on Future Operational Environmental Satellite Systems, 9th, Austin, TX, 6-10 January 2013. Boston, MA, American Meteorological Society, 2013.

Li, Jinlong; Li, J.; Wang, P.; Goldberg, M., and Schmit, T. J. Development of assimilation demonstration system using JPSS sounder data for tropical cyclone forecasts. Annual Symposium on Future Operational Environmental Satellite Systems, 9th, Austin, TX, 6-10 January 2013. Boston, MA, American Meteorological Society, 2013.



Li, Jun; Schmit, T. J.; Li, J.; Wang, P., and Zheng, J. Improving tropical cyclone forecasts in regional NWP with GOES-R imaging and JPSS sounding data. Special Symposium on the Joint Center for Satellite Data Assimilation, Austin, TX, 6-10 January 2013. Boston, MA, American Meteorological Society, 2013.

Li, Zhenglong; Li, J.; Li, Y.; Li, T.; Schmit, T. J., and Barnet, C. D. NPP sounding validation and evaluation. Annual Symposium on Future Operational Environmental Satellite Systems, 9th, Austin, TX, 6-10 January 2013. Boston, MA, American Meteorological Society, 2013.

Li, Zhenglong; Li, J.; Li, Y.; Zhang, Y.; Schmit, T. J.; Zhou, L.; Goldberg, M., and Menzel, P. Determining diurnal variations of land surface emissivity from geostationary satellites. Annual Symposium on Future Operational Environmental Satellite Systems, 9th, Austin, TX, 6-10 January 2013. Boston, MA, American Meteorological Society (AMS), 2013.

Lim, Agnes; Jung, J. A., and Ackerman, S. Assimilation of AIRS radiances using GSI/WRF for short term regional forecasts. Annual Symposium on Future Operational Environmental Satellite Systems, 9th, Austin, TX, 6-10 January 2013. Boston, MA, American Meteorological Society, 2013.

Lindstrom, Scott S.; Feltz, W.; Bachmeier, S.; Sieglaff, J.; Crouce, L.; Calvert, C., and Pavolonis, M. Leveraging the GOES-R Proving Ground process and forecaster feedback to improve GOES-R products and training material. Conference on Transition of Research to Operations, 3rd, Austin, TX, 6-10 January 2013. Boston, MA, American Meteorological Society, 2013.

Monette, Sarah A.; Bedka, K., and Feltz, W. F. Applications of satellite data to aircraft turbulence. Conference on Aviation, Range, and Aerospace Meteorology, 16th, Austin, TX, 6-10 January 2013. Boston, MA, American Meteorological Society, 2013.

Mooney, Margaret; Ackerman, S.; Jackson, N.; Ruscher, P., and Rowley, P. Satellite meteorology resources and the GOES-R Education Proving Ground. Annual Symposium on Future Operational Environmental Satellite Systems, 9th, Austin, TX, 6-10 January 2013. Boston, MA, American Meteorological Society, 2013.

Mooney, Margaret; Cahlan, L.; Ackerman, S.; Jackson, N.; Chambers, L. H., and Whittaker, T. M. The CIMSS iPad Library and ESIP Teacher Workshops. Symposium on Education, 22nd, Austin, TX, 6-10 January 2013. Boston, MA, American Meteorological Society, 2013.

Mostek, Anthony; Ogren, J.; Motta, B.; Gurka, J., and Schmit, T. J. Training in the NOAA Satellite Proving Ground - getting users ready for rapid changes. Annual Symposium on Future Operational Environmental Satellite Systems, 9th, Austin, TX, 6-10 January 2013. Boston, MA, American Meteorological Society, 2013.

Murray, John J.; Haynes, J. A.; Vernier, J. P.; Pavolonis, M. J., and Krotkov, N. A. Optimal use of satellite data applications for the volcanic ash threat to aviation. Conference on Aviation, Range, and Aerospace Meteorology, 16th, Austin, TX, 6-10 January 2013. Boston, MA, American Meteorological Society, 2013.

Nalli, Nicholas R.; Barnet, C. D.; Divakarla, M.; Gu, D.; Liu, X.; Kizer, S.; Zhou, L.; Tobin, D.; Reale, T.; Gambacorta, A.; Wilson, M.; Xiong, X.; Maddy, E.; Joseph, E.; Morris, V. R.; Wolfe, D. E.; Mollner, A.; Knuteson, R. T., and Goldberg, M. D. Cal/Val program status for



Environmental Data Record (EDR) products from the Suomi NPP Cross-track Infrared Microwave Sounder Suite (CrIMSS). Annual Symposium on Future Operational Environmental Satellite Systems, 9th, Austin, TX, 6-10 January 2013. Boston, MA, American Meteorological Society, 2013.

Nalli, Nicholas R.; Barnet, C. D.; Gambacorta, A.; Maddy, E.; King, T. S.; Xie, H.; Joseph, E.; Morris, V., and Smith, W. L. Sr. On the angular effect of residual clouds, aerosols, and sun-glint in clear-sky IR radiance observations: Experimental analyses. Annual Symposium on Future Operational Environmental Satellite Systems, 9th, Austin, TX, 6-10 January 2013. Boston, MA, American Meteorological Society, 2013.

Newchurch, Mike; Alvarez, R.; Al-Saadi, J. A.; Burris, J.; Cantrell, W.; Chen, G.; De Young, R.; Hardesty, M.; Hoff, R.; Kaye, J. A.; Kuang, S.; Langford, A. O.; Leblanc, T.; McDermid, I. S.; McGee, T. J.; Pierce, B.; Senff, C., and Sullivan J. Tropospheric Ozone Lidar Network (TOLNet) - Long-term tropospheric ozone and aerosol profiling for satellite continuity and process studies. Symposium on Lidar Atmospheric Applications, 6th, Austin, TX, 6-10 January 2013. Boston, MA, American Meteorological Society, 2013.

Otkin, Jason A.; Anderson, M. C.; Hain, C.; Mladenova, I. E.; Basara, J. B., and Svoboda, M. D. Examining flash drought development using the Evaporative Stress Index (ESI). Conference on Hydrology, 27th, Austin, TX, 6-10 January 2013. Boston, MA, American Meteorological Society, 2013.

Parker, David; Gumley, L. E., and Achtor, T. H. Weather satellite data for mobile devices. Conference on Environmental Information Processing Technologies, 29th, formerly IIPS, Austin, TX, 6-10 January 2013. Boston, MA, American Meteorological Society, 2013.

Parker, David; Santek, D. A.; Batzlie, S.; Bearson, N., and Dengel, R. SSEC web map service: Real-time and forecast product mashups. Conference on Environmental Information Processing Technologies, 29th, formerly IIPS, Austin, TX, 6-10 January 2013. Boston, MA, American Meteorological Society, 2013.

Pitts, Katherine; Nasiri, S. L.; Yang, P.; Smith, N., and Demko, A. L. Comparison of Suomi NPP VIIRS and EOS MODIS cloud retrieval products using a uniform space-time algorithm. Conference on Transition of Research to Operations, 3rd, Austin, TX, 6-10 January 2013. Boston, MA, American Meteorological Society, 2013.

Pu, Zhaoxia; Velden, C.; Aberson, S., and Reynolds, C. A. Assimilation of satellite data in improving numerical simulations of tropical cyclones: Lessons learned from field programs in last decade. Special Symposium on the Joint Center for Satellite Data Assimilation, Austin, TX, 6-10 January 2013. Boston, MA, American Meteorological Society, 2013.

Reale, Anthony L.; Sun, B.; Pettey, M.; Tilley, F.; Nalli, N. R.; Tobin, D. C., and Barnet, C. D. Performance validation of candidate operational sounding retrievals from Suomi-NPP. Annual Symposium on Future Operational Environmental Satellite Systems, 9th, Austin, TX, 6-10 January 2013. Boston, MA, American Meteorological Society, 2013.

Revercomb, Henry E.; Tobin, D. C.; Knuteson, R. O.; Taylor, J. K.; DeSlover, D.; Borg, L.; Martin, G., and Quinn, G. Suomi NPP/JPSS Cross-track Infrared Sounder (CrIS): Radiometric and spectral performance. Annual Symposium on Future Operational Environmental Satellite





Systems, 9th, Austin, TX, 6-10 January 2013. Boston, MA, American Meteorological Society, 2013.

Reynolds, Carolyn A.; Langland, R. H.; Pauley, P. M., and Velden, C. S. Tropical cyclone data impact studies from T-PARC. Conference on Integrated Observing and Assimilation Systems for the Atmosphere, Oceans, and Land Surface, 17th, IOAS-AOLS, Austin, TX, 6-10 January 2013. Boston, MA, American Meteorological Society, 2013.

Rink, Thomas D.; Gumley, L. E.; Strabala, K. I., and Menzel, W. P. Analyzing VIIRS and CrIS data with HYDRA2. Conference on Environmental Information Processing Technologies, 29th, formerly IIPS, Austin, TX, 6-10 January 2013. Boston, MA, American Meteorological Society, 2013.

Rogers, Matthew A.; Miller, S. D.; Heidinger, A. K., and Sengupta, M. Short-term surface insolation forecasts derived from satellite cloud advection techniques. Conference on Weather, Climate and the New Energy Economy, 4th, Austin, TX, 6-10 January 2013. Boston, MA, American Meteorological Society, 2013.

Rogers, Ryan Hunter; Carey, L.; Bedka, K.; Fleege, C.; Feltz, W., and Monette, S. A. Total lightning in a multi-sensor approach to the detection and forecasting of convectively induced turbulence. Conference on the Meteorological Applications of Lightning Data, 6th, Austin, TX, 6-10 January 2013. Boston, MA, American Meteorological Society, 2013.

Rowley, Patrick; Ackerman, S.; Arkin, P.; Pisut, D. P.; Kohrs, R. A.; Mooney, M., and Uz, S. Schollaert. Communicating climate forecasts via NOAA's Science on a Sphere: The EarthNow Project. Conference on Applied Climatology, 20th, Austin, TX, 6-10 January 2013. Boston, MA, American Meteorological Society, 2013.

Rowley, Patrick; Mooney, M.; Ackerman, S.; Achtor, T.; Gerth, J.; Gjermo, B., and Wade, G. S. Celebrating 20 years of the CIMSS Student Workshop. Symposium on Education, 22nd, Austin, TX, 6-10 January 2013. Boston, MA, American Meteorological Society, 2013.

Santek, David A. and Key, J. R. High latitude satellite-derived winds: Use and impact over the last decade. Special Symposium on the Joint Center for Satellite Data Assimilation, Austin, TX, 6-10 January 2013. Boston, MA, American Meteorological Society, 2013.

Santek, David A.; Phillips, J., and Achtor, T. H. McIDAS: Forty years of visualizing weather satellite data. History Symposium, 11th, Austin, TX, 6-10 January 2013. Boston, MA, American Meteorological Society, 2013.

Schmit, Timothy J.; Gunshor, M.; Bah, K.; Gurka, J., and Otkin, J. A. Preparing for the Advanced Baseline Imager on the GOES-R series. Annual Symposium on Future Operational Environmental Satellite Systems, 9th, Austin, TX, 6-10 January 2013. Boston, MA, American Meteorological Society, 2013.

Schmit, Timothy J.; Gurka, J.; Gunshor, M.; Menzel, P., and Phillips, J. The history and evolution of the ABI (Advanced Baseline Imager) on the GOES-R series. History Symposium, 11th, Austin, TX, 6-10 January 2013. Boston, MA, American Meteorological Society, 2013.

Sengupta, Manajit; Habte, A.; Wilcox, S.; Molling, C., and Heidinger, A. K. Validating a physical model for satellite based solar resource assessment. Conference on Weather, Climate



and the New Energy Economy, 4th, Austin, TX, 6-10 January 2013. Boston, MA, American Meteorological Society, 2013.

Smith, William L. Sr.; Weisz, E.; Smith, N., and Larar, A. Observing atmospheric dynamics from satellite sounding pairs. Special Symposium on Advancing Weather and Climate Forecasts: Innovative Techniques and Applications, Austin, TX, 6-10 January 2013. Boston, MA, American Meteorological Society, 2013.

Strabala, Kathleen I.; Gumley, L. E.; Huang, A.; Davies, J.; Weisz, E.; Key, J. R., and Pierce, B. The global impact of 10+ years of IMAPP software in support of Aqua and Terra. Conference on Transition to Research to Operations, 3rd, , Austin, TX, 6-10 January 2013. Boston, MA, American Meteorological Society, 2013.

Strabala, Kathleen I.; Hoese, D.; Garcia, R.; Straka, W.; Schiffer, E.; Gerth, J.; Bachmeier, S.; Gumley, L.; Huang, A.; Batzlie, S.; Heinrichs, T., and Hungershofer, K. VIIRS in AWIPS: Supporting operational forecasts. Annual Symposium on Future Operational Environmental Satellite Systems, 9th, Austin, TX, 6-10 January 2013. Boston, MA, American Meteorological Society, 2013.

Straka, William C. III; Achtor, T. H.; Rink, T. D.; Jasmin, T.; Bah, K., and Schmit, T. J. McIDAS-V, visualization and data analysis for GOES-R. Annual Symposium on Future Operational Environmental Satellite Systems, 9th, Austin, TX, 6-10 January 2013. Boston, MA, American Meteorological Society, 2013.

Straka, William C. III; Jasmin, T.; Rink, T. D.; Lindsey, D. T.; Hillger, D. W.; Miller, S. D., and Achtor, T. H. McIDAS-V, visualization and data analysis for Suomi National Polar-orbiting Partnership. Conference on Environmental Information Processing Technologies, 29th, formerly IIPS, Austin, TX, 6-10 January 2013. Boston, MA, American Meteorological Society, 2013.

Taylor, Joe K.; Revercomb, H. E.; Best, F. A.; Tobin, D. C.; Knuteson, R. O.; Gero, P J.; Garcia, R. K.; Ciganovich, N. C.; LaPorte, D. D.; Werner, M. W. ; DeSlover, D., and Borg, L. Suomi NPP/JPSS Cross-track Infrared Sounder (CrIS): Calibration validation with the aircraft based Scanning High-resolution Interferometer Sounder (S-HIS). Annual Symposium on Future Operational Environmental Satellite Systems, 9th, Austin, TX, 6-10 January 2013. Boston, MA, American Meteorological Society, 2013.

Terborg, Amanda M. and Gravelle, C. M. The GOES-R Proving Ground 2012 summer experiment at the Aviation Weather Center. Conference on Aviation, Range, and Aerospace Meteorology, 16th, Austin, TX, 6-10 January 2013. Boston, MA, American Meteorological Society, 2013.

Tobin, David C.; Revercomb, H.; Knuteson, R.; Taylor, J., and DeSlover, D. Cal/val of CrIS on Suomi-NPP: Intercalibration with AIRS, IASI, and VIIRS. Annual Symposium on Future Operational Environmental Satellite Systems, 9th, Austin, TX, 6-10 January 2013. Boston, MA, American Meteorological Society, 2013.

Wang, Chenxi; Ding, S. Sr.; Yang, P.; Baum, B., and Dessier, A. A new method to retrieve cirrus cloud height with MODIS observations. Annual Symposium on Future Operational Environmental Satellite Systems, 9th, Austin, TX, 6-10 January 2013. Boston, MA, American Meteorological Society, 2013.



Wang, Pei; Li, J.; Schmit, T. J., and Li, J. Improve tropical cyclone forecasts with hyperspectral infrared sounder data . Conference on Integrated Observing and Assimilation Systems for the Atmosphere, Oceans, and Land Surface, 17th, IOAS-AOLS, Austin, TX, 6-10 January 2013. Boston, MA, American Meteorological Society, 2013.

Wimmers, Anthony; Feltz, W. F., and Monette, S. A. Further methods for identifying turbulence within satellite gravity wave signatures. Conference on Aviation, Range, and Aerospace Meteorology, 16th, Austin, TX, 6-10 January 2013. Boston, MA, American Meteorological Society, 2013.

Wolf, Walter; Sampson, S.; Liu, X.; Li, A.; Yu, T.; Garcia, R.; Martin, G.; Straka, W. III; Schiffer, E., and Daniels, J. GOES-R AWG Product Processing System framework: Current capabilities and future plans. Annual Symposium on Future Operational Environmental Satellite Systems, 9th, Austin, TX, 6-10 January 2013. Boston, MA, American Meteorological Society, 2013.

Wong, Eric; Heidinger, A.; Holz, R. E.; Walther, A.; Oo, M. M., and Ou, S. C. Assessment of the SNPP VIIRS cloud optical properties and cloud top parameters using the Calipso lidar measurements. Annual Symposium on Future Operational Environmental Satellite Systems, 9th, Austin, TX, 6-10 January 2013. Boston, MA, American Meteorological Society, 2013.

Wu, Ting-Chi; Liu, H.; Velden, C.; Majumdar, S. J., and Anderson, J. Toward understanding the contribution of satellite-derived atmospheric motion vectors to numerical tropical cyclone analyses and forecasts. Conference on Integrated Observing and Assimilation Systems for the Atmosphere, Oceans, and Land Surface, 17th, IOAS-AOLS, Austin, TX, 6-10 January 2013. Boston, MA, American Meteorological Society, 2013.

Yi, Bingqi; Yang, P.; Baum, B., and L'Ecuyer, T. A new parameterization of ice cloud optical properties for applications in radiative transfer models and general circulation models. Special Symposium on Advancing Weather and Climate Forecasts: Innovative techniques and Applications, Austin, TX, 6-10 January 2013. Boston, MA, American Meteorological Society, 2013.

## **2012**

Achter, Thomas. Application of hyperspectral sounding radiances for algorithm development and evaluation using McIDAS-V. 2012 EUMETSAT Meteorological Satellite Conference, Portland, OR, 3-7 September 2012. Proceedings. Darmstadt, Germany, European Organization for the Exploitation of Meteorological Satellites (EUMETSAT), 2012.

Achter, Thomas H.; Rink, Thomas; Straka, William, and Feltz, Joleen. A powerful visualization and data analysis tool for geostationary environmental satellites. AGU Fall Meeting, San Francisco, CA, 3-7 December 2012. Washington, DC, American Geophysical Union, 2012.

Ackerman, Steven. Trends in cloud properties derived from satellite observations of the Great Lakes. 2012 EUMETSAT Meteorological Satellite Conference, Portland, OR, 3-7 September 2012. Proceedings. Darmstadt, Germany, European Organization for the Exploitation of Meteorological Satellites (EUMETSAT), 2012.

Anderson, Martha C.; Diak, G.; Mecikalski, J. R., and Hain, C. Calibrating GOES-based insolation products for climatological analyses of evapotranspiration of the US. Conference on



Climate Variability and Change, 24th, New Orleans, LA, 22-26 January 2012. Boston, MA, American Meteorological Society, 2012.

Bah, Kaba; Achtor, T.; Rink, T. D.; Schmit, T. J.; Otkin, J., and Gerth, J. Preparation for use of the GOES-R Advanced Baseline Imager (ABI). Annual Symposium on Future Operational Environmental Satellite Systems, 8th, New Orleans, LA, 22-26 January 2012. Boston, MA, American Meteorological Society, 2012.

Bah, Kaba; Gerth, Jordan; Feltz, Wayne, and Schmit, Tim. UW-CIMSS Satellite products to the NWS forecast offices via AWIPS. National Weather Association annual meeting, 37th, Madison, WI, 6-11 October 2012. Raleigh, NC, National Weather Association, 2012.

Baker, Nancy; Langland, Rolf; Pauley, Pat; Merkova, Dagmar; Gelaro, Ron, and Velden, Chris. An investigation of the impact of Atmospheric Motion Vectors on NAVDAS-AR/NOGAPS. International Winds Workshop, 11th, Auckland, New Zealand, 20-24 February 2012. Madison, WI, University of Wisconsin-Madison, Cooperative Institute for Meteorological Satellite Studies (CIMSS), 2012.

Baker, Nancy L.; Langland, Rolf; Pauley, Patricia M.; Xu, Liang; Merkova, Dagmar; Gelaro, Ron, and Velden, Christopher. The impact of satellite Atmospheric Motion Vectors in the US Navy global data assimilation system - NWP results. International Winds Workshop, 11th, Auckland, New Zealand, 20-24 February 2012. Darmstadt, Germany, EUMETSAT, 2012.

Beamesderfer, Eric R.; Ortega, K. L.; Smith, T. M., and Cintineo, J. L. Comparison of estimated and observed storm motions to environmental parameters. Conference on Interactive Information Processing Systems (IIPS), 28th, New Orleans, LA, 22-26 January 2012. Boston, MA, American Meteorological Society, 2012.

Bennartz, Ralf. Cloud liquid water path: Revisiting an essential but under-utilized climate variable. 2012 EUMETSAT Meteorological Satellite Conference, Portland, OR, 3-7 September 2012. Proceedings. Darmstadt, Germany, European Organization for the Exploitation of Meteorological Satellites (EUMETSAT), 2012.

Beven, Jack; Brennan, Michael; Cobb, Hugh; DeMaria, Mark; Knaff, John; Velden, Christopher; Dunion, Jason; Jedlovec, Gary, and Fuell, Kevin. The 2011 GOES-R proving ground activities at the National Hurricane Center. Interdepartmental Hurricane Conference, 66th, Charleston, SC, 5-9 March 2012. Washington, DC, US Department of Commerce, National Oceanic and Atmospheric Administration (NOAA), Office of the Federal Coordinator for Meteorology, 2012.

Bikos, Dan; Braun, Jeff; Connell, Bernie; Lindstrom, Scott, and Bachmeier, Scott. Recent VISIT and SHyMet Training: Applications of Satellite Imagery and Products to Operational Forecasting. National Weather Association annual meeting, 37th, Madison, WI, 6-11 October 2012. Raleigh, NC, National Weather Association, 2012.

Bormann, Niels; Hernandez-Carrascal, Angeles; Borde, Regis; Lutz, Hans-Joachim, and Wanzong, Steve. Using geostationary imagery from high-resolution model simulations to improve the characterisation of current Atmospheric Motion Vectors. 2012 EUMETSAT Meteorological Satellite Conference, Portland, OR, 3-7 September 2012. Proceedings. Darmstadt, Germany, European Organization for the Exploitation of Meteorological Satellites (EUMETSAT), 2012.



Bormann, Niels and Santek, David. Report from Working Group 2 (WG2): NWP. International Winds Workshop, 11th, Auckland, New Zealand, 20-24 February 2012. Darmstadt, Germany, EUMETSAT, 2012.

Brunner, Jason; Bedka, Kristopher; Dworak, Richard; Feltz, Wayne, and Fleeger, Cecila. GOES objective overshooting top and enhanced-V signature detection products: Algorithm description, validation, and applications. National Weather Association annual meeting, 37th, Madison, WI, 6-11 October 2012. Raleigh, NC, National Weather Association, 2012.

Brunner, Jason; Pierce, R. Bradley, and Lenzen, Allen. GOES-R AWG visibility retrieval. National Weather Association annual meeting, 37th, Madison, WI, 6-11 October 2012. Raleigh, NC, National Weather Association, 2012.

Brunner, Jason C.; Bedka, K.; Dworak, R.; Feltz, W. F., and Counce, L. M. GOES-R overshooting top and enhanced-V signature detection product objective validation efforts. Conference on Satellite Meteorology, Oceanography and Climatology, 18th, and Joint AMS-Asia Satellite Meteorology Conference, 1st, New Orleans, LA, 22-26 January 2012. Boston, MA, American Meteorological Society, 2012.

Brunner, Jason C.; Schmidt, C. C.; Prins, E. M.; Hoffman, J. P.; Schroeder, W., and Csiszar, I. Western Hemisphere diurnal fire activity 1995-2011: Description and initial fire trend analysis of the GOES-East Version 6.5 WF-ABBA data archive. Conference on Satellite Meteorology, Oceanography and Climatology, 18th, and Joint AMS-Asia Satellite Meteorology Conference, 1st, New Orleans, LA, 22-26 January 2012. Boston, MA, American Meteorological Society, 2012.

Calder, John; Proshutinsky, Andrey; Carmack, Eddy; Ashik, Igor; Leong, Harald; Key, Jeff; McCammon, Molly; Melling, Humfrey; Perovich, Donald; Eicken, Hajo; Johnson, Mark, and Rigor, Ignatius. Proceeding of OceanObs'09, Sustained Ocean Observations and Information for Society, Venice, Italy, 21-25 September 2009, v.2. s.l., European Space Agency (ESA), 2012.

Calvert, Corey and Pavolonis, Michael. A quantitative fog/low stratus detection algorithm for GOES-R. National Weather Association annual meeting, 37th, Madison, WI, 6-11 October 2012. Raleigh, NC, National Weather Association, 2012.

Calvert, Corey G. and Pavolonis, M. J. A quantitative fog/low stratus detection algorithm for GOES-R. Annual Symposium on Future Operational Environmental Satellite Systems, 8th, New Orleans, LA, 22-26 January 2012. Boston, MA, American Meteorological Society, 2012.

Cintineo, John L.; Michael J. Pavolonis, Michael J., and Sieglaff, Justin M. Probabilistic forecasting of severe convection. National Weather Association annual meeting, 37th, Madison, WI, 6-11 October 2012. Raleigh, NC, National Weather Association, 2012.

Connell, Bernadette H.; Bikos, D.; Braun, J.; Bachmeier, A. S.; Lindstrom, S.; Mostek, A.; Davison, M.; Caesar, K. A.; Castro, V.; Veeck, L.; DeMaria, M., and Schmit, T. J. Satellite training activities: VISIT, SHyMet and WMO VLab Focus Group. Annual Symposium on Future Operational Environmental Satellite Systems, 8th, New Orleans, LA, 22-26 January 2012. Boston, MA, American Meteorological Society, 2012.



Craven, Jeffrey P.; Cronce, Marcia R.; Davis, Steve; Feltz, Wayne F., and Gerth, Jordan J. GOES R Proving Ground: CIMSS/NWS Sullivan 2012. National Weather Association annual meeting, 37th, Madison, WI, 6-11 October 2012. Raleigh, NC, National Weather Association, 2012.

Csiszar, Ivan; Barnet, C. D.; Ferraro, R.; Flynn, L. E.; Heidinger, A. K.; Hillger, D. W.; Ignatov, A.; Key, J.; Kondragunta, S.; Laszio, I., and Wang, M. Overview of NPP/JPSS environmental data products and algorithm development. Annual Symposium on Future Operational Environmental Satellite Systems, 8th, New Orleans, LA, 22-26 January 2012. Boston, MA, American Meteorological Society, 2012.

Cureton, Geoff P.; Garcia, Ray; Strabala, Kathy, and Gumley, Liam. VIIRS atmospheric products in the Community Satellite Processing Package (CSPP) (Poster presentation). International TOVS Study Conference, 18th, ITSC-18, Toulouse, France, 20-27 March 2012. Madison, WI, University of Wisconsin-Madison, Space Science and Engineering Center, Cooperative Institute for Meteorological Satellite Studies (CIMSS), 2012.

Dahlman, LuAnn and Mooney, Margaret E. The CIMSS iPad library and ESIP teacher workshops. AGU Fall Meeting, San Francisco, CA, 3-7 December 2012. Washington, DC, American Geophysical Union, 2012.

Daniels, Jaime; Bresky, Wayne; Bailey, Andrew; Wanzong, Steve, and Velden, Chris. Atmospheric Motion Vectors derived via a New Nested tracking algorithm developed for the GOES-R Advanced Baseline Imager (ABI). International Winds Workshop, 11th, Auckland, New Zealand, 20-24 February 2012. Madison, WI, University of Wisconsin-Madison, Cooperative Institute for Meteorological Satellite Studies (CIMSS), 2012.

Daniels, Jaime M.; Bresky, W.; Wanzong, S., and Velden, C. S. Atmospheric motion vectors derived via a new nested tracking algorithm developed for the GOES-R Advanced Baseline Imager (ABI). Annual Symposium on Future Operational Environmental Satellite Systems, 8th, New Orleans, LA, 22-26 January 2012. Boston, MA, American Meteorological Society, 2012.

Daniels, Jamie; Bresky, Wayne; Wanzong, Steve; Bailey, Andrew, and Velden, Christopher. Atmospheric Motion Vectors derived via a new nested tracking algorithm developed for the GOES-R Advanced Baseline Imager (ABI). International Winds Workshop, 11th, Auckland, New Zealand, 20-24 February 2012. Darmstadt, Germany, EUMETSAT, 2012.

Davies, James; Strabala, Kathy; Schiffer, Eva; Pierce, R. Bradley, and Huang, Hung-Lung. IDEA-I: A globally configurable IMAPP MODIS software package in support of air quality forecasts. 2012 EUMETSAT Meteorological Satellite Conference, Portland, OR, 3-7 September 2012. Proceedings. Darmstadt, Germany, European Organization for the Exploitation of Meteorological Satellites (EUMETSAT), 2012.

Dengel, Russell; Batzli, Sam; Parker, Dave; Bearson, Nick, and Santek, Dave. Rapid access to real-time and forecast products through a web map service. National Weather Association annual meeting, 37th, Madison, WI, 6-11 October 2012. Raleigh, NC, National Weather Association, 2012.

DeSlover, Daniel. An analysis of Scanning-HIS retrievals from the global Hawk Hurricane and Severe Storm Sentinel (HS3) science flights. 2012 EUMETSAT Meteorological Satellite Conference, Portland, OR, 3-7 September 2012. Proceedings. Darmstadt, Germany, European Organization for the Exploitation of Meteorological Satellites (EUMETSAT), 2012.



Dunion, Jason; Thorncroft, C.; Velden, C. S.; Emanuel, K., and Nolan, D. S. Diurnal pulsing of tropical cyclones: An overlooked yet fundamental TC process? Conference on Hurricanes and Tropical Meteorology, 30th, Ponte Vedra Beach, FL, 15-20 April 2012. Boston, MA, American Meteorological Society, 2012.

Dunion, Jason; Thorncroft, Chris, and Velden, Chris. Diurnal pulsing of tropical cyclones: An overlooked yet fundamental TC process? Interdepartmental Hurricane Conference, 66th, Charleston, SC, 5-9 March 2012. Washington, DC, US Department of Commerce, National Oceanic and Atmospheric Administration (NOAA), Office of the Federal Coordinator for Meteorology, 2012.

Dworak, Richard; Bedka, K.; Brunner, J., and Feltz, W. Comparison between GOES-12 overshooting top detections, WSR-88D radar reflectivity and severe storm reports. Conference on Satellite Meteorology, Oceanography and Climatology, 18th, and Joint AMS-Asia Satellite Meteorology Conference, 1st, New Orleans, LA, 22-26 January 2012. Boston, MA, American Meteorological Society, 2012.

Feltz, Joleen M.; Bah, K.; Rink, T., and Achtor, T. GOES-R proving ground aviation weather products displayed in McIDAS-V. Conference on Satellite Meteorology, Oceanography and Climatology, 18th, and Joint AMS-Asia Satellite Meteorology Conference, 1st, New Orleans, LA, 22-26 January 2012. Boston, MA, American Meteorological Society, 2012.

Feltz, Michaelle; Knuteson, R.; Tobin, D.; Ackerman, S.; Revercomb, H., and Reale, A. Methodology for the validation of temperature profile Environmental Data Records (EDRs) from the Cross-track Infrared Microwave Sounding Suite (CrIMSS): Experience with GPS radio occultation from COSMIC. Annual Symposium on Future Operational Environmental Satellite Systems, 8th, New Orleans, LA, 22-26 January 2012. Boston, MA, American Meteorological Society, 2012.

Feltz, Wayne. Comparison between objective GOES-12 imager overshooting top detectors, WSR-88D radar reflectivity and severe storm reports. 2012 EUMETSAT Meteorological Satellite Conference, Portland, OR, 3-7 September 2012. Proceedings. Darmstadt, Germany, European Organization for the Exploitation of Meteorological Satellites (EUMETSAT), 2012.

Foster, Michael. Estimating uncertainties in the PATMOS-x AVHRR/VIIRS cloud climatological records. 2012 EUMETSAT Meteorological Satellite Conference, Portland, OR, 3-7 September 2012. Proceedings. Darmstadt, Germany, European Organization for the Exploitation of Meteorological Satellites (EUMETSAT), 2012.

Garcia, R.; Strabala, K.; Schiffer, E., and Cureton, G. Open-source tools for the Community Satellite Processing Package (Poster presentation). International TOVS Study Conference, 18th, ITSC-18, Toulouse, France, 20-27 March 2012. Madison, WI, University of Wisconsin-Madison, Space Science and Engineering Center, Cooperative Institute for Meteorological Satellite Studies (CIMSS), 2012.

Garms, Elise M.; Knuteson, R.; Menzel, P.; Revercomb, H.; Plokhenko, Y.; Smith, W. L., and Weisz, E. Use of active and passive satellite remote sensing from the NASA A-Train to investigate the relationship between cloud structure and hurricane intensification. Conference on Satellite Meteorology, Oceanography and Climatology, 18th, and Joint AMS-Asia Satellite Meteorology Conference, 1st, New Orleans, LA, 22-26 January 2012. Boston, MA, American Meteorological Society, 2012.



Genkova, Iliana; Weissmann, Martin, and Wanzong, Steve. Satellite and airborne wind-LIDAR Atmospheric Motion Vectors comparison - A case study . International Winds Workshop, 11th, Auckland, New Zealand, 20-24 February 2012. Madison, WI, University of Wisconsin-Madison, Cooperative Institute for Meteorological Satellite Studies (CIMSS), 2012.

Genkova, Iliana; Weissmann, Martin, and Wanzong, Steve. Satellite and airborne wind-lidar Atmospheric Motion Vectors comparison - A case study. International Winds Workshop, 11th, Auckland, New Zealand, 20-24 February 2012. Darmstadt, Germany , EUMETSAT, 2012.

Gerth, Jordan. Linear optimization as a solution to improve the sky cover guess, forecast. National Weather Association annual meeting, 37th, Madison, WI, 6-11 October 2012. Raleigh, NC, National Weather Association, 2012.

Gerth, Jordan J. How AWIPS II is a tool to further R20 in the GOES-R era. Conference on Satellite Meteorology, Oceanography and Climatology, 18th, and Joint AMS-Asia Satellite Meteorology Conference, 1st, New Orleans, LA, 22-26 January 2012. Boston, MA , American Meteorological Society, 2012.

Gravelle, Chad M.; Pavolonis, Michael J., and Calvert, Corey G. GOES-R fog and low cloud product demonstration within the National Weather Service Central Region . National Weather Association annual meeting, 37th, Madison, WI, 6-11 October 2012. Raleigh, NC, National Weather Association, 2012.

Greenwald, Tom; Bennartz, Ralf, and Davies, Jim. Optimizing multiple scattering calculations in the CRTM. JCSDA Workshop on Satellite Data Assimilation, 10th, College Park, MD, 10-12 October 2012. College Park, MD, NOAA Center for Weather and Climate Prediction, Joint Center for Satellite Data Assimilation (JCSDA), 2012.

Greenwald, Tom; Lee, Y. K., and Huang, A. Validation of cirrus infrared scattering properties used in the production of simulated GOES-R ABI proxy data. Annual Symposium on Future Operational Environmental Satellite Systems, 8th, New Orleans, LA, 22-26 January 2012. Boston, MA, American Meteorological Society, 2012.

Gultepe, Ismail; Kuhn, T.; Pavolonis, M. J.; Calvert, C. G.; Gurka, J. J.; Ware, R.; Vukovic, Z. R.; Sloan, J., and Milbrandt, J. Ice fog (pogonip) and frost in Arctic: Application to aviation and nowcasting. Aviation, Range and Aerospace Meteorology, 3rd, Special Symposium on Weather-Air Traffic Management Integration, New Orleans, LA, 22-26 January 2012. Boston, MA, American Meteorological Society, 2012.

Gumley, Liam; Huang, Allen; Mindock, Scott ; Martin, Graeme; Garcia, Ray; Cureton, Geoff; Strabala, Kathy; Weisz, Elisabeth; Smith, Nadia, and Smith, Bill. Community Satellite Processing Package (CSPP) for NPP/JPSS (Powerpoint presentation). International TOVS Study Conference, 18th, ITSC-18, Toulouse, France, 20-27 March 2012. Madison, WI, University of Wisconsin-Madison, Space Science and Engineering Center, Cooperative Institute for Meteorological Satellite Studies (CIMSS), 2012.

Gurka, James; Goodman, Steve; Schmit, Timothy; De Maria, Mark, and Mostek, Anthony. The GOES-R Proving Ground: User input from the 2012 demonstrations and future plans. National Weather Association annual meeting, 37th, Madison, WI, 6-11 October 2012. Raleigh, NC, National Weather Association, 2012.





Gurka, James J.; Goodman, S.; Schmit, T. J.; DeMaria, M.; Mostek, A.; Siewert, C. W., and Reed, B. The GOES-R proving ground: 2012 update. Annual Symposium on Future Operational Environmental Satellite Systems, 8th, New Orleans, LA, 22-26 January 2012. Boston, MA, American Meteorological Society, 2012.

Hart, Caitlin J. and Sieglaff, J. A temporal analysis of severe storm reports and GOES satellite-measured microphysical properties of severe convection. Conference on Satellite Meteorology, Oceanography and Climatology, 18th, and Joint AMS-Asia Satellite Meteorology Conference, 1st, New Orleans, LA, 22-26 January 2012. Boston, MA, American Meteorological Society, 2012.

Hartung, Daniel C.; Sieglaff, J.; Crounce, L. M., and Feltz, W. F. Development and application of a satellite-based cloud object-tracking methodology. Conference on Satellite Meteorology, Oceanography and Climatology, 18th, and Joint AMS-Asia Satellite Meteorology Conference, 1st, New Orleans, LA, 22-26 January 2012. Boston, MA, American Meteorological Society, 2012.

Heck, Patrick W.; Minnis, P.; Bedka, S. T. ; Yost, C. R., and Ayers, J. K. Retrieval of nighttime cloud optical and microphysical properties for GOES-R. Annual Symposium on Future Operational Environmental Satellite Systems, 8th, New Orleans, LA, 22-26 January 2012. Boston, MA, American Meteorological Society, 2012.

Heidinger, Andrew. Comparison of the AVHRR cloud climatologies recently released from EUMETSAT and NOAA. 2012 EUMETSAT Meteorological Satellite Conference, Portland, OR, 3-7 September 2012. Proceedings. Darmstadt, Germany, European Organization for the Exploitation of Meteorological Satellites (EUMETSAT), 2012.

Heidinger, Andrew K.; Foster, M. J.; Molling, C.; Straka, W., and Walther, A. Advances in long-term high spatial and temporal resolution cloud climate records from PATMOS-x using NOAA's LEO and GEO imagers. Conference on Satellite Meteorology, Oceanography and Climatology, 18th, and Joint AMS-Asia Satellite Meteorology Conference, 1st, New Orleans, LA, 22-26 January 2012. Boston, MA, American Meteorological Society, 2012.

Hernandez-Carrascal, Angeles; Bormann, Niels; Borde, Regis; Lutz, Hans-Joachim , and Wanzong, Steve. Using model simulations to improve the characterisation of current Atmospheric Motion Vectors. International Winds Workshop, 11th, Auckland, New Zealand, 20-24 February 2012. Darmstadt, Germany, EUMETSAT, 2012.

Hernandez-Carrascal, A.; Bormann, N.; Borde, R.; Lutz, J.-J., and Wanzong, S. Using model simulations to improve the characteristics of current Atmospheric Motion Vectors . International Winds Workshop, 11th, Auckland, New Zealand, 20-24 February 2012. Madison, WI, University of Wisconsin-Madison, Cooperative Institute for Meteorological Satellite Studies (CIMSS), 2012.

Herndon, Derrick and Velden, C. S. Estimating tropical cyclone intensity using SSMIS and ATMS sounders. Conference on Hurricanes and Tropical Meteorology, 30th, Ponte Vedra Beach, FL, 15-20 April 2012. Boston, MA, American Meteorological Society, 2012.

Herndon, Derrick; Velden, C. S., and Hawkins, J. D. Update on SATellite-based CONsensus (SATCON) approach to TC intensity estimation. Conference on Hurricanes and Tropical Meteorology, 30th, Ponte Vedra Beach, FL, 15-20 April 2012. Boston, MA, American Meteorological Society, 2012.



Herndon, Derrick; Velden, Chris, and Hawkins, Jeff. CIMSS SATellite CONsensus algorithm for estimating the intensity of tropical cyclones. National Weather Association annual meeting, 37th, Madison, WI, 6-11 October 2012. Raleigh, NC, National Weather Association, 2012.

Hillger, Donald W. and Schmit, T. J. GOES science tests: Results for the last two of the current GOES series. Conference on Satellite Meteorology, Oceanography and Climatology, 18th, and Joint AMS-Asia Satellite Meteorology Conference, 1st, New Orleans, LA, 22-26 January 2012. Boston, MA, American Meteorological Society, 2012.

Hoffman, Jay P.; Schmidt, C. C.; Prins, E. M., and Brunner, J. C. The GOES-R fire detection algorithm from research to operations. Annual Symposium on Future Operational Environmental Satellite Systems, 8th, New Orleans, LA, 22-26 January 2012. Boston, MA, American Meteorological Society, 2012.

Holmlund, Ken and Wanzong, Steve. Report from Working Group 1 (WG1): Wind extraction methods. International Winds Workshop, 11th, Auckland, New Zealand, 20-24 February 2012. Darmstadt, Germany, EUMETSAT, 2012.

Hoover, Brett; Santek, Dave; Lazzara, Matthew; Dworak, Rich; Velden, Chris; Key, Jeff, and Bearson, Nick. High latitude satellite derived winds from combined geostationary and polar orbiting satellite data. International Winds Workshop, 11th, Auckland, New Zealand, 20-24 February 2012. Darmstadt, Germany, EUMETSAT, 2012.

Hoover, Brett Santek Dave; Lazzara, Matt; Dworak, Rich; Key, Jeff; Velden, Chris, and Bearson, Nick. High latitude satellite-derived winds from combined geostationary and polar orbiting satellite data. International Winds Workshop, 11th, Auckland, New Zealand, 20-24 February 2012. Madison, WI, University of Wisconsin-Madison, Cooperative Institute for Meteorological Satellite Studies (CIMSS), 2012.

Huang, Hung-Lung Allen. Community Satellite Processing Package (CSPP): An enabling technology for NPP/JPSS Real-Time Regional (RTR) applications. 2012 EUMETSAT Meteorological Satellite Conference, Portland, OR, 3-7 September 2012. Proceedings. Darmstadt, Germany, European Organization for the Exploitation of Meteorological Satellites (EUMETSAT), 2012.

Huang, Hung-Lung Allen. GeoMetWatch-STORM: The next-generation ultra-spectral geostationary sounding and imaging for scale-coupled real-time regional applications. 2012 EUMETSAT Meteorological Satellite Conference, Portland, OR, 3-7 September 2012. Proceedings. Darmstadt, Germany, European Organization for the Exploitation of Meteorological Satellites (EUMETSAT), 2012.

Huang, Hung-Lung Allen; Gumley, L., and Strabala, K. Community Satellite Processing Package (CSPP) - A critical infrastructure towards building a sustained global user capability for NPP/JPSS Real Time Regional (RTR) applications. Annual Symposium on Future Operational Environmental Satellite Systems, 8th, New Orleans, LA, 22-26 January 2012. Boston, MA, American Meteorological Society, 2012.

Huang, Hung-Lung Allen; Huang, B., and Goldberg, M. D. Progress and plan for the development of a research-to-operation high-performance and low-cost GPU-based satellite data processing and application enabling technology. Symposium on Integrated Observing and



Assimilation Systems for the Atmosphere, Oceans, and Land Surface (IOAS-AOLS), 16th, New Orleans, LA, 22-26 January 2012. Boston, MA, American Meteorological Society, 2012.

Huang, Hung-Lung Allen; Smith, W. L.; Crain, D.; Pache, E., and Elwell, J. GeoMetWatch-STORM: Global constellation of next-generation ultra-spectral geostationary observatories. Conference on Satellite Meteorology, Oceanography and Climatology, 18th, and Joint AMS-Asia Satellite Meteorology Conference, 1st, New Orleans, LA, 22-26 January 2012. Boston, MA, American Meteorological Society, 2012.

Jung, James; Garrett, Kevin, and Riishojgaard, Lars Peter. Atmospheric Motion Vector impact study using the NCEP Global Forecast System. International Winds Workshop, 11th, Auckland, New Zealand, 20-24 February 2012. Madison, WI, University of Wisconsin-Madison, Cooperative Institute for Meteorological Satellite Studies (CIMSS), 2012.

Jung, James; Garrett, Kevin, and Riishojgaard, Lars Peter. Atmospheric Motion Vector impact study using the NCEP global forecast system. International Winds Workshop, 11th, Auckland, New Zealand, 20-24 February 2012. Darmstadt, Germany, EUMETSAT, 2012.

Jung, James and Riishojgaard, Lars Peter. Observing system experiments using the NCEP Global Data Assimilation System. JCSDA Workshop on Satellite Data Assimilation, 10th, College Park, MD, 10-12 October 2012. College Park, MD, NOAA Center for Weather and Climate Prediction, Joint Center for Satellite Data Assimilation (JCSDA), 2012.

Jung, James A. and Le Marshall, J. F. Tropospheric impacts of assimilating infrared water vapor radiances in the NCEP GFS. Conference on Satellite Meteorology, Oceanography and Climatology, 18th, and Joint AMS-Asia Satellite Meteorology Conference, 1st, New Orleans, LA, 22-26 January 2012. Boston, MA, American Meteorological Society, 2012.

Kain, John S.; Dembek, S. R.; Rabin, R. M.; Weiss, S. J., and Marsh, P. T. A realtime high-resolution forecast model for research and operations. Conference on Interactive Information Processing Systems (IIPS), 28th, New Orleans, LA, 22-26 January 2012. Boston, MA, American Meteorological Society, 2012.

Kaplan, J.; Rozoff, C. M.; Sampson, C. R.; Kossin, J. P.; Velden, C., and Demaria, M. Improvements to the SHIPS Rapid Intensification Index (RII). Interdepartmental Hurricane Conference, 66th, Charleston, SC, 5-9 March 2012. Washington, DC, US Department of Commerce, National Oceanic and Atmospheric Administration (NOAA), Office of the Federal Coordinator for Meteorology, 2012.

Kaplan, John; Rozoff, C. M.; Sampson, C. R.; Koss, J. P.; Velden, C. S.; DeMaria, M., and Knaff, J. A. Assessing the predictability of tropical cyclone rapid intensification as a function of forecast lead-time using the SHIPS Rapid Intensification Index. Conference on Hurricanes and Tropical Meteorology, 30th, Ponte Vedra Beach, FL, 15-20 April 2012. Boston, MA, American Meteorological Society, 2012.

Kepert, Jeffrey D.; Velden, C. S.; Ritchie, E. A., and Caroff, P. The Seventh International Workshop on Tropical Cyclones. Conference on Hurricanes and Tropical Meteorology, 30th, Ponte Vedra Beach, FL, 15-20 April 2012. Boston, MA, American Meteorological Society, 2012.



Key, Jeff; Ddworak, Richard; Santek, David ; Bresky, Wayne; Wanzong, Steve; Daniels, Jaime; Bailey, Andrew; Velden, Christopher; Qi, Hongming; Keehn, Pete, and Wolf, Walter. Polar winds from VIIRS. International Winds Workshop, 11th, Auckland, New Zealand, 20-24 February 2012. Darmstadt, Germany, EUMETSAT, 2012.

Key, Jeff; Dworak, Richard; Santek, Dave; Bresky, Wayne; Wanzong, Steve; Daniels, Jaime; Bailey, Andrew; Velden, Chris; Qi, Hongming; Keehn, Pete, and Wolf, Walter. Polar winds from VIIRS . International Winds Workshop, 11th, Auckland, New Zealand, 20-24 February 2012. Madison, WI, University of Wisconsin-Madison, Cooperative Institute for Meteorological Satellite Studies (CIMSS), 2012.

Knaff, John; DeMaria, M.; Hillger, D. W.; Lindsey, D. T.; Molenaar, D. A.; Beven, J. L. II; Brennan, M. J.; Cobb, H. D. III; Brummer, R.; Schumacher, A. B.; Dunion, J.; Fuell, K. K.; Molthan, A. L., and Velden, C. S. Overview of the GOES-R Proving Ground activities at National Hurricane Center. Conference on Hurricanes and Tropical Meteorology, 30th, Ponte Vedra Beach, FL, 15-20 April 2012. Boston, MA, American Meteorological Society, 2012.

Knuteson, Bob; Antonelli, Paolo; Garcia, Ray; DeSlover, Dan; Revercomb, Hank; Best, Fred; Tobin, Dave; Taylor, Joe; Gero, Jon; Ciganovich, Nick; Smith, Bill; Weisz, Elisabeth, and Garms, Elise. S-HIS retrieval results: HS3 2011 test flights. Comparisons to GDAS, IR satellite, HAMSr, and dropsondes. HS3 Science and Deployment Preparation Meeting, Wallops Flight Facility, VA, 7-8 May 2012. National Aeronautics and Space Administration (NASA), Earth Science Project Office (ESPO), 2012.

Knuteson, Robert; Tobin, D.; Sorce, A.; Roman, J.; Ackerman, S.; Revercomb, H., and Turner, D. D. Methodology for the validation of water vapor profile Environmental Data Records (EDRs) from the Cross-track Infrared Microwave Sounding Suite (CrIMSS): Experience with the DOE ARM water vapor raman lidar. Annual Symposium on Future Operational Environmental Satellite Systems, 8th, New Orleans, LA, 22-26 January 2012. Boston, MA, American Meteorological Society, 2012.

Kossin, James; Sitkowski, Matthew; Lewis, William, and Rozoff, Christopher. Eyewall replacement cycles: Forecasting onset and associated intensity and structure changes. A joint hurricane testbed project. Interdepartmental Hurricane Conference, 66th, Charleston, SC, 5-9 March 2012. Washington, DC, US Department of Commerce, National Oceanic and Atmospheric Administration (NOAA), Office of the Federal Coordinator for Meteorology, 2012.

Lakshmanan, Valliappa; Rabin, R.; Otkin, J. A.; Kain, J. S., and Dembek, S. R. Visualizing model data using a fast approximation of a radiative transfer model. Conference on Artificial Intelligence Applications to Environmental Science, 10th, New Orleans, LA, 22-26 January 2012. Boston, MA, American Meteorological Society, 2012.

Lane, Sarah E.; West, Leanne L.; Gimmestad, Gary G.; Kireev, Stanislav; Smith, William L. Sr.; Burdette, Edward M.; Daniels, Taumi, and Cornman, Larry. Hyperspectral image turbulence measurements of the atmosphere. Infrared Imaging Systems: Design, Analysis, Modeling, and Testing XXIII, Baltimore, MD, 24 April 2012. Bellingham, WA, SPIE-The International Society for Optical Engineering, 2012. Paper 83550N.

Lee, Yong-Keun; Li, Z., and Li, J. Validation of GOES-R LAP algorithm with GOES-13 sounder. Annual Symposium on Future Operational Environmental Satellite Systems, 8th, New Orleans, LA, 22-26 January 2012. Boston, MA, American Meteorological Society, 2012.



Lewis, Wililam E.; Velden, C. S.; Majumdar, S. J., and Rappin, E. D. Hourly assimilation of enhanced AMVs for tropical cyclone initialization using a novel ensemble bogus method. Conference on Hurricanes and Tropical Meteorology, 30th, Ponte Vedra Beach, FL, 15-20 April 2012. Boston, MA, American Meteorological Society, 2012.

Li, Jun; Goldberg, M. D.; Li, J.; Liu, H.; Zheng, J.; Schmit, T. J.; Barnet, C. D.; Zhou, L., and Huang, A. Evaluation and application of JPSS products through assimilation in regional NWP models. Annual Symposium on Future Operational Environmental Satellite Systems, 8th, New Orleans, LA, 22-26 January 2012. Boston, MA, American Meteorological Society, 2012.

Li, Jun; Li, J.; Liu, H.; Zheng, J., and Schmit, J. T. Improving high impact weather forecasts through assimilating the satellite advance infrared soundings in regional NWP models. Symposium on Integrated Observing and Assimilation Systems for the Atmosphere, Oceans, and Land Surface (IOAS-AOLS), 16th, New Orleans, LA, 22-26 January 2012. Boston, MA, American Meteorological Society, 2012.

Li, Jun; Schmit, Tim; Li, Jinlong; Wang, Pei, and Liu, Hui. Assimilating GOES-R water vapor and JPSS sounding data for improving tropical cyclone forecasts with WRF/GSI. JCSDA Workshop on Satellite Data Assimilation, 10th, College Park, MD, 10-12 October 2012. College Park, MD, NOAA Center for Weather and Climate Prediction, Joint Center for Satellite Data Assimilation (JCSDA), 2012.

Li, Zhenglong; Li, J.; Weisz, E., and Li, J. A fast physical algorithm for hyperspectral sounding retrieval. Annual Symposium on Future Operational Environmental Satellite Systems, 8th, New Orleans, LA, 22-26 January 2012. Boston, MA, American Meteorological Society, 2012.

Lim, Agnes; Jung, Jim; Huang, Allen, and Ackerman, Steve. Assimilation of AIRS radiances using GSI/WRF for short term regional forecasts. National Weather Association annual meeting, 37th, Madison, WI, 6-11 October 2012. Raleigh, NC, National Weather Association, 2012.

Lindsey, Daniel T.; Schmit, T. J.; MacKenzie, W. M. Jr.; Grasso, L.; Gunshor, M., and Jewett, C. P. The 10.35 micrometer band: A more appropriate window band for GOES-R ABI than 11.2? Annual Symposium on Future Operational Environmental Satellite Systems, 8th, New Orleans, LA, 22-26 January 2012. Boston, MA, American Meteorological Society, 2012.

Lindstrom, Scott; Bachmeier, A. Scott; Feltz, Wayne F.; Sieglaff, Justin M., and Pavolonis, Mike. Leveraging the GOES-R Proving Ground process and forecaster feedback to improve GOES-R products and training material. National Weather Association annual meeting, 37th, Madison, WI, 6-11 October 2012. Raleigh, NC, National Weather Association, 2012.

Line, William; Petersen, Ralph; Aune, Robert, and Dworak, Richard. Future improvements to very-short-range forecasts of the pre-convective environment using operational geostationary satellite observations. National Weather Association annual meeting, 37th, Madison, WI, 6-11 October 2012. Raleigh, NC, National Weather Association, 2012.

Liu, Hui; Velden, C.; Li, J.; Majumdar, S., and Anderson, J. Impact of integrated satellite observations on forecasts of tropical cyclones: A case study. Conference on Hurricanes and Tropical Meteorology, 30th, Ponte Vedra Beach, FL, 15-20 April 2012. Boston, MA, American Meteorological Society, 2012.



Majumdar, Sharanya J.; Aberson, S. D.; Bishop, C. H.; Cardinali, C.; Coughey, J.; Doerenbecher, A.; Gauthier, P.; Gelaro, R.; Hamell, T.; Langland, R.; Lorenc, A.; Nakazawa, T.; Rabier, F.; Reynolds, C. A.; Saunder, R.; Song, Y.; Toth, Z.; Velden, C.; Weissmann, M., and Wu, C. C. Targeted observations for improving numerical weather prediction: An overview. Symposium on Integrated Observing and Assimilation Systems for the Atmosphere, Oceans, and Land Surface (IOAS-AOLS), 16th, New Orleans, LA, 22-26 January 2012. Boston, MA, American Meteorological Society, 2012.

Mecikalski, John R.; Lindsey, D. T.; Velden, C. S.; Vant-Hull, B. L., and Rabin, R. M. Convective storm forecasting 1-6 hours prior to initiation. Annual Symposium on Future Operational Environmental Satellite Systems, 8th, New Orleans, LA, 22-26 January 2012. Boston, MA, American Meteorological Society, 2012.

Mekhtontsev, S.; Hanssen, L. M.; Rice, J. P.; Zeng, J.; Khromchenko, V.; Best, F. A., and Dykema, J. A. Comparative study of blackbody emissivity using reflectometry, modeling and radiance measurements. International Temperature Symposium, 9th, Los Angeles, CA, 19-23 March 2012. [Washington, DC], Department of Commerce, National Institute of Standards and Technology, 2012. Session G-2, Paper 3.

Minnis, Patrick; Sun-Mack, S.; Bedka, S. T.; Palikonda, R.; Chang, F. L.; Chen, Y.; Arduini, R. F.; Heck, P. W.; Dong, X., and Xi, B. Toward an optimal algorithm for retrieving cloud properties over snow and ice covered surfaces. Conference on Satellite Meteorology, Oceanography and Climatology, 18th, and Joint AMS-Asia Satellite Meteorology Conference, 1st, New Orleans, LA, 22-26 January 2012. Boston, MA, American Meteorological Society, 2012.

Monette, Sarah A.; Velden, C. S., and Griffin, K. S. Examining trends in satellite-detected overshooting tops as a potential predictor of tropical cyclone rapid intensification. Conference on Hurricanes and Tropical Meteorology, 30th, Ponte Vedra Beach, FL, 15-20 April 2012. Boston, MA, American Meteorological Society, 2012.

Monette, Sarah A.; Velden, Christopher S.; Griffin, Kyle S., and Rozoff, Christopher M. Examining trends in satellite-detected overshooting tops as a potential predictor of tropical cyclone rapid intensification. National Weather Association annual meeting, 37th, Madison, WI, 6-11 October 2012. Raleigh, NC, National Weather Association, 2012.

Mooney, Margaret; Ackerman, Steve; Kapela, Rusty, and Parker, Dave. Engaging storm spotters and college students in regional responses to climate change. National Weather Association annual meeting, 37th, Madison, WI, 6-11 October 2012. Raleigh, NC, National Weather Association, 2012.

Mostek, Anthony; Gurka, J.; Schmit, T. J., and Spayd, L. Jr. Training in the NOAA satellite proving ground. Annual Symposium on Future Operational Environmental Satellite Systems, 8th, New Orleans, LA, 22-26 January 2012. Boston, MA, American Meteorological Society, 2012.

Nalli, Nicholas R.; Barnet, C. D.; Gambacorta, A.; Maddy, E., and Smith, W. L. Sr. On the zenith angular effect of residual clouds and aerosols in clear-sky IR window radiance observations. Annual Symposium on Future Operational Environmental Satellite Systems, 8th, New Orleans, LA, 22-26 January 2012. Boston, MA, American Meteorological Society, 2012.



Nasiri, Shaima L.; Yang, P.; Baum, B., and Heidinger, A. K. Building a framework for evaluating NPP and JPSS VIIRS cloud property retrievals. Symposium on Integrated Observing and Assimilation Systems for the Atmosphere, Oceans, and Land Surface (IOAS-AOLS), 16th, New Orleans, LA, 22-26 January 2012. Boston, MA, American Meteorological Society, 2012.

Nebuda, Sharon; Jung, James; Santek, Dave; Daniels, Jamie, and Bresky, Wayne. Evaluation and quality control of nested tracking approach for Atmospheric Motion Vectors (AMVs). International Winds Workshop, 11th, Auckland, New Zealand, 20-24 February 2012. Darmstadt, Germany, EUMETSAT, 2012.

Nebuda, Sharon; Jung, Jim; Santek, Dave; Daniels, Jaime, and Bresky, Wayne. Evaluation and quality control of nested tracking approach for AMVs. International Winds Workshop, 11th, Auckland, New Zealand, 20-24 February 2012. Madison, WI, University of Wisconsin-Madison, Cooperative Institute for Meteorological Satellite Studies (CIMSS), 2012.

Olander, Timothy and Velden, C. The Advanced Dvorak Technique (ADT) - Current status and latest advancements. Conference on Satellite Meteorology, Oceanography and Climatology, 18th, and Joint AMS-Asia Satellite Meteorology Conference, 1st, New Orleans, LA, 22-26 January 2012. Boston, MA, American Meteorological Society, 2012.

Olander, Timothy and Velden, Christopher. The UW-CIMSS Advanced Dvorak Technique (ADT). National Weather Association annual meeting, 37th, Madison, WI, 6-11 October 2012. Raleigh, NC, National Weather Association, 2012.

Olander, Timothy L. and Velden, C. S. The Advanced Dvorak Technique (ADT) - Planned research and development avenues for continued algorithm improvement. Conference on Hurricanes and Tropical Meteorology, 30th, Ponte Vedra Beach, FL, 15-20 April 2012. Boston, MA, American Meteorological Society, 2012.

Olander, Timothy L. and Velden, C. S. The current status of the UW-CIMSS Advanced Dvorak Technique (ADT). Conference on Hurricanes and Tropical Meteorology, 30th, Ponte Vedra Beach, FL, 15-20 April 2012. Boston, MA, American Meteorological Society, 2012.

Otkin, Jason; Jones, Thomas; Knopfmeier, Kent, and Stensrud, David. Evaluation of assimilating simulated radar and satellite observations during a cool season OSSE. National Weather Association annual meeting, 37th, Madison, WI, 6-11 October 2012. Raleigh, NC, National Weather Association, 2012.

Otkin, Jason A. Assessing the impact of the horizontal covariance localization radius used during the assimilation of infrared brightness temperature observations. Symposium on Integrated Observing and Assimilation Systems for the Atmosphere, Oceans, and Land Surface (IOAS-AOLS), 16th, New Orleans, LA, 22-26 January 2012. Boston, MA, American Meteorological Society, 2012.

Otkin, Jason A.; Bikos, D.; Sieglaff, J.; Lindsay, D. T.; Grasso, L.; Siewart, C. W.; Rabin, R.; Kain, J. S., and Dembek, S. R. Using synthetic satellite imagery to evaluate real-time model forecast performance during the Hazardous Weather Testbed Spring Experiment. Conference on Satellite Meteorology, Oceanography and Climatology, 18th, and Joint AMS-Asia Satellite Meteorology Conference, 1st, New Orleans, LA, 22-26 January 2012. Boston, MA, American Meteorological Society, 2012.



Pauley, Patricia M.; Baker, Nancy L.; Langland, Rolf; Xu, Liang, and Velden, Chris. The impact of satellite Atmospheric Motion Vectors in the U.S. Navy Global Data Assimilation System: The superob procedure. International Winds Workshop, 11th, Auckland, New Zealand, 20-24 February 2012. Madison, WI, University of Wisconsin-Madison, Cooperative Institute for Meteorological Satellite Studies (CIMSS), 2012.

Pauley, Patricia M.; Baker, Nancy L.; Langland, Rolf; Xu, Liang, and Velden, Christopher. The impact of satellite Atmospheric Motion Vectors in the US Navy global data assimilation system: The superob procedure. International Winds Workshop, 11th, Auckland, New Zealand, 20-24 February 2012. Darmstadt, Germany, EUMETSAT, 2012.

Pavolonis, Michael J.; Calvert, C. G., and Sieglaff, J. New quantitative volcanic cloud and fog products for GOES-R. Annual Symposium on Future Operational Environmental Satellite Systems, 8th, New Orleans, LA, 22-26 January 2012. Boston, MA, American Meteorological Society, 2012.

Pavolonis, Michael J. and Sieglaff, J. Satellite retrievals of Eyjafjallajokull, Grimsvotn, and Puyehue-Cordon Caulle volcanic ash cloud properties: Evaluation of near real-time results and suggestions for improving operational satellite products. Conference on Interactive Information Processing Systems (IIPS), 28th, New Orleans, LA, 22-26 January 2012. Boston, MA, American Meteorological Society, 2012.

Petersen, Ralph A. and Aune, R. M. Tests of objective short-range forecasts of the pre-convective environment using geostationary satellite data. Annual Symposium on Future Operational Environmental Satellite Systems, 8th, New Orleans, LA, 22-26 January 2012. Boston, MA, American Meteorological Society, 2012.

Petersen, Ralph A.; Aune, Robert; Dworak, Richard, and Line, William. Using analyses of the information content of GOES/SEVIRI moisture products to improve very-short-range forecasts of the pre-convective environment. 2012 EUMETSAT Meteorological Satellite Conference, Portland, OR, 3-7 September 2012. Proceedings. Darmstadt, Germany, European Organization for the Exploitation of Meteorological Satellites (EUMETSAT), 2012.

Petersen, Ralph A.; Aune, Robert; Line, William, and Dworak, Richard. Improving very-short-range forecasts of the pre-convective environment using operational geostationary satellite observations. National Weather Association annual meeting, 37th, Madison, WI, 6-11 October 2012. Raleigh, NC, National Weather Association, 2012.

Pierce, R. Bradley; Schaack, Todd; Lenzen, Allen, and Lee, Pius. Implementation of GOES total column ozone assimilation within NAM-CMAQ to improve operational air quality forecasting capabilities. JCSDA Workshop on Satellite Data Assimilation, 10th, College Park, MD, 10-12 October 2012. College Park, MD, NOAA Center for Weather and Climate Prediction, Joint Center for Satellite Data Assimilation (JCSDA), 2012.

Reki, Jeffrey S.; Johnson, R. S.; Hyer, E.; Zhang, J.; Campbell, J. R.; Christopher, S. A.; Di Girolamo, L.; Giglio, L.; Hoffman, J. P.; Holben, B.; Holz, R.; Kuciauskas, A. P.; Liew, S. C.; Miettinen, J.; Turk, F. J.; Wang, J.; Welton, E. J., and Xian, P. Observing and understanding the Southeast Asian Aerosol Environment: A survey of remote sensing tools for the 7 Southeast Asian Studies (7SEAS) program. Conference on Satellite Meteorology, Oceanography and Climatology, 18th, and Joint AMS-Asia Satellite Meteorology Conference, 1st, New Orleans, LA, 22-26 January 2012. Boston, MA, American Meteorological Society, 2012.





Rink, Thomas; Jasmin, T., and Achtor, T. Engineering support for JPSS instruments and data formats in McIDAS-V. Annual Symposium on Future Operational Environmental Satellite Systems, 8th, New Orleans, LA, 22-26 January 2012. Boston, MA, American Meteorological Society, 2012.

Rink, Thomas D.; Jasmin, T., and Achtor, T. McIDAS-V: Visualization and analysis capabilities for JPSS. Annual Symposium on Future Operational Environmental Satellite Systems, 8th, New Orleans, LA, 22-26 January 2012. Boston, MA, American Meteorological Society, 2012.

Roman, Jacola A.; Ackerman, S. A.; Knuteson, R.; Revercomb, H.; Smith, W. L. Sr., and Tobin, D. Using satellite Atmospheric Infrared Sounder (AIRS) and a ground-based Global Positioning Satellite (GPS) network to validate the Precipitable Water Vapor (PWV) in Global Climate Models (GCMs) and Numerical Weather Prediction (NWP) regional reanalysis. Conference on Satellite Meteorology, Oceanography and Climatology, 18th, and Joint AMS-Asia Satellite Meteorology Conference, 1st, New Orleans, LA, 22-26 January 2012. Boston, MA, American Meteorological Society, 2012.

Rowley, C. Patrick; Ackerman, S. A.; Pisut, D. P., and Mooney, M. EarthNow: Weather and climate connections for 3D spherical displays. Symposium on Education, 21st, New Orleans, LA, 22-26 January 2012. Boston, MA, American Meteorological Society, 2012.

Rozoff, Christopher; Velden, C. S.; Kaplan, J.; Wimmers, A., and Kossin, J. P. Improvements in the probabilistic prediction of tropical cyclone rapid intensification resulting from inclusion of satellite passive microwave observations. Interdepartmental Hurricane Conference, 6 6th, Charleston, SC, 5-9 March 2012. Washington, DC, US Department of Commerce, National Oceanic and Atmospheric Administration (NOAA), Office of the Federal Coordinator for Meteorology, 2012.

Rozoff, Christopher M.; Velden, C. S.; Kaplan, J.; Wimmers, A., and Kossin, J. P. Improvements in the probabilistic prediction of tropical cyclone rapid intensification resulting from inclusion of satellite passive microwave observations. Conference on Hurricanes and Tropical Meteorology, 30th, Ponte Vedra Beach, FL, 15-20 April 2012. Boston, MA, American Meteorological Society, 2012.

Santek, David. Feature tracked winds from moisture fields derived from satellite sounders. 2012 EUMETSAT Meteorological Satellite Conference, Portland, OR, 3-7 September 2012. Proceedings. Darmstadt, Germany, European Organization for the Exploitation of Meteorological Satellites (EUMETSAT), 2012.

Santek, David; Hoover, Brett, and Jung, James. Assimilation and forecast impacts using the expected error in the quality control of MODIS polar winds. International Winds Workshop, 11th, Auckland, New Zealand, 20-24 February 2012. Darmstadt, Germany, EUMETSAT, 2012.

Santek, David; Hoover, Brett; Jung, James, and Nebuda, Sharon. Quality control of MODIS and AVHRR polar winds in the GDAS/GFS: Status and plans. JCSDA Workshop on Satellite Data Assimilation, 10th, College Park, MD, 10-12 October 2012. College Park, MD, NOAA Center for Weather and Climate Prediction, Joint Center for Satellite Data Assimilation (JCSDA), 2012.

Santek, David and Hoover, Brett Jung James. Assimilation and forecast impacts using the expected error in the quality control of MODIS polar winds. International Winds Workshop,



11th, Auckland, New Zealand, 20-24 February 2012. Madison, WI, University of Wisconsin-Madison, Cooperative Institute for Meteorological Satellite Studies (CIMSS), 2012.

Santek, David; Nebuda, Sharon; Velden, Chris; Key, Jeff, and Stettner, Dave. Deriving Atmospheric Motion Vectors From AIRS moisture retrieval data . International Winds Workshop, 11th, Auckland, New Zealand, 20-24 February 2012. Madison, WI, University of Wisconsin-Madison, Cooperative Institute for Meteorological Satellite Studies (CIMSS), 2012.

Santek, David; Nebuda, Sharon; Velden, Christopher; Key, Jeff, and Stettner, Dave. Deriving Atmospheric Motion Vectors from AIRS moisture retrieval data. International Winds Workshop, 11th, Auckland, New Zealand, 20-24 February 2012. Darmstadt, Germany, EUMETSAT, 2012.

Santek, David A.; Hoover, B. T., and Jung, J. A. The quality control of satellite-derived polar winds using the expected error. Symposium on Integrated Observing and Assimilation Systems for the Atmosphere, Oceans, and Land Surface (IOAS-AOLS), 16th, New Orleans, LA, 22-26 January 2012. Boston, MA, American Meteorological Society, 2012.

Santek, David A.; Parker, D.; Bearson, N.; Dengel, R., and Batzli, S. Using mobile devices to display, overlay, and animate meteorological data and imagery. Conference on Interactive Information Processing Systems (IIPS), 28th, New Orleans, LA, 22-26 January 2012. Boston, MA, American Meteorological Society, 2012.

Santek, David A.; Rabin, R. M.; Dengel, R.; Batzli, S.; Lakshmanan, V., and Lindsey, D. T. Rapid access to real-time and forecast products through a web map service and N-wave data circuits. Conference on Interactive Information Processing Systems (IIPS), 28th, New Orleans, LA, 22-26 January 2012. Boston, MA, American Meteorological Society, 2012.

Schmidt, Christopher C.; Prins, E. M.; Hyer, E.; Hoffman, J. P.; Brunner, J., and Reid, J. S. The global geostationary Wildfire ABBA: Current implementation and future plans. Conference on Satellite Meteorology, Oceanography and Climatology, 18th, and Joint AMS-Asia Satellite Meteorology Conference, 1st, New Orleans, LA, 22-26 January 2012. Boston, MA, American Meteorological Society, 2012.

Schmit, Timothy J.; Gunshor, Mathew M.; Bah, Kaba; Gurka, James J., and Otkin, Jason. Operational uses of the ABI (Advanced Baseline Imager) on the GOES-R series. National Weather Association annual meeting, 37th, Madison, WI, 6-11 October 2012. Raleigh, NC, National Weather Association, 2012.

Schreck, Carl J. III; Kossin, J. P.; Knapp, K. R., and Hennon, P. A. Global tropical cyclone climatology using IBTrACS. Conference on Hurricanes and Tropical Meteorology, 30th, Ponte Vedra Beach, FL, 15-20 April 2012. Boston, MA, American Meteorological Society, 2012.

Schreiner, Anthony; Menzel, W. Paul; Straka, William, and Heidinger, Andy. Comparing CO<sub>2</sub>/IRW and H<sub>2</sub>O/IRW CTPs . International Winds Workshop, 11th, Auckland, New Zealand, 20-24 February 2012. Madison, WI, University of Wisconsin-Madison, Cooperative Institute for Meteorological Satellite Studies (CIMSS), 2012.

Schreiner, Anthony J.; Menzel, W. Paul; Straka, William, and Heidinger, Andrew. Comparison of CO<sub>2</sub> and H<sub>2</sub>O Atmospheric Motion Vector height assignment techniques using the GOES-13 imager. International Winds Workshop, 11th, Auckland, New Zealand, 20-24 February 2012. Darmstadt, Germany , EUMETSAT, 2012.



Sears, John and Velden, C. S. Investigating the role of the upper-levels in tropical cyclogenesis. Conference on Hurricanes and Tropical Meteorology, 30th, Ponte Vedra Beach, FL, 15-20 April 2012. Boston, MA, American Meteorological Society, 2012.

Sears, John and Velden, Chris. Providing satellite product support for the Hurricane and Severe Storm Sentinel (HS3) field program. National Weather Association annual meeting, 37th, Madison, WI, 6-11 October 2012. Raleigh, NC, National Weather Association, 2012.

Sieglauff, Justin; Lee Cronic, Lee, and Feltz, Wayne. Using UW-cloud top cooling rates in convective storm warning experiments. National Weather Association annual meeting, 37th, Madison, WI, 6-11 October 2012. Raleigh, NC, National Weather Association, 2012.

Sieglauff, Justin; Pavolonis, M. J., and Hartung, D. C. Probabilistic nowcasting of severe convection using the temporal evolution of satellite-derived deep convection cloud properties. Conference on Satellite Meteorology, Oceanography and Climatology, 18th, and Joint AMS-Asia Satellite Meteorology Conference, 1st, New Orleans, LA, 22-26 January 2012. Boston, MA, American Meteorological Society, 2012.

Sitkowski, Matthew; Kossin, J. P.; Rozoff, C. M., and Knaff, J. A. Intensity and structure changes during hurricane eyewall replacement cycles. Conference on Hurricanes and Tropical Meteorology, 30th, Ponte Vedra Beach, FL, 15-20 April 2012. Boston, MA, American Meteorological Society, 2012.

Sitkowski, Matthew; Kossin, J. P.; Rozoff, C. M., and Knaff, J. A. Thermodynamic evolution of the hurricane inner-core during Eyewall Replacement Cycles and ramifications of the relict wind maximum. Conference on Hurricanes and Tropical Meteorology, 30th, Ponte Vedra Beach, FL, 15-20 April 2012. Boston, MA, American Meteorological Society, 2012.

Smith, Nadia; Menzel, W. P.; Weisz, E., and Baum, B. A uniform space-time grid for the inter-comparison of global cloud top pressure retrievals. Conference on Interactive Information Processing Systems (IIPS), 28th, New Orleans, LA, 22-26 January 2012. Boston, MA, American Meteorological Society, 2012.

Smith, William. Atmospheric dynamics from NPP/Aqua and Metop-A/Metop-B sounding pairs. 2012 EUMETSAT Meteorological Satellite Conference, Portland, OR, 3-7 September 2012. Proceedings. Darmstadt, Germany, European Organization for the Exploitation of Meteorological Satellites (EUMETSAT), 2012.

Smith, William L. Sr.; Weisz, E.; Knuteson, R.; Dutcher, S., and Revercomb, H. Atmospheric trends from satellite hyperspectral radiance measurements. Symposium on Integrated Observing and Assimilation Systems for the Atmosphere, Oceans, and Land Surface (IOAS-AOLS), 16th, New Orleans, LA, 22-26 January 2012. Boston, MA, American Meteorological Society, 2012.

Stettner, Dave; Velden, Chris, and Olander, Tim. CIMSS tropical cyclones web page. National Weather Association annual meeting, 37th, Madison, WI, 6-11 October 2012. Raleigh, NC, National Weather Association, 2012.

Strabala, Kathleen; Garcia, Ray; Hoese, David; Schiffer, Eva; Gerth, Jordan; Bachmeier, Scott; Gumley, Liam, and Broderson, Dayne. VIIRS data in AWIPS: Supporting operational forecasters. National Weather Association annual meeting, 37th, Madison, WI, 6-11 October 2012. Raleigh, NC, National Weather Association, 2012.



Strabala, Kathleen; Gumley, Liam; Huang, Hung-Lung; Henrichs, Thomas A., and Hungershofer, Katju. VIIRS in AWIPS: Supporting operational forecasters. AGU Fall Meeting, San Francisco, CA, 3-7 December 2012. Washington, DC, American Geophysical Union, 2012.

Straka, William C. III; Rink, T. D.; Achtor, T. H.; Schmit, T. J., and Bah, K. McIDAS-V, visualization and data analysis for GOES-R. Annual Symposium on Future Operational Environmental Satellite Systems, 8th, New Orleans, LA, 22-26 January 2012. Boston, MA, American Meteorological Society, 2012.

Straka, William III. GOES-R AWG product processing system framework: Baseline algorithm overview. 2012 EUMETSAT Meteorological Satellite Conference, Portland, OR, 3-7 September 2012. Proceedings. Darmstadt, Germany, European Organization for the Exploitation of Meteorological Satellites (EUMETSAT), 2012.

Straka, William III; Achtor, T. H.; Rink, T. D.; Heidinger, A. K.; Schmit, T. J., and Jasmin, T. Routine satellite derived product monitoring and validation from GOES, JPSS and GOES-R. Symposium on Integrated Observing and Assimilation Systems for the Atmosphere, Oceans, and Land Surface (IOAS-AOLS), 16th, New Orleans, LA, 22-26 January 2012. Boston, MA, American Meteorological Society, 2012.

Su, Xiujuan; Derber, John, and Jung, James . Recent work on satellite Atmospheric Motion Vectors in the NCEP data assimilation system. International Winds Workshop, 11th, Auckland, New Zealand, 20-24 February 2012. Darmstadt, Germany, EUMETSAT, 2012.

Su, Xiujuan; Derber, John, and Jung, James . Recent works on satellite winds in NCEP data assimilation system (GSI) . International Winds Workshop, 11th, Auckland, New Zealand, 20-24 February 2012. Madison, WI, University of Wisconsin-Madison, Cooperative Institute for Meteorological Satellite Studies (CIMSS), 2012.

Tschudi, Mark A.; Maslanik, J. A.; Wang, X. Sr.; Liu, Y., and Key, J. Evaluation of ice characterization from NPP VIIRS. Annual Symposium on Future Operational Environmental Satellite Systems, 8th, New Orleans, LA, 22-26 January 2012. Boston, MA, American Meteorological Society, 2012.

Vant-Hull, Brian L.; Mahani, S.; Khanbilvardi, R., and Rabin, R. M. Observations of convective cloud towers and precipitation initiation, intensity and frequency. Conference on Hydrology, 26th, New Orleans, LA, 22-26 January 2012. Boston, MA, American Meteorological Society, 2012.

Velden, Christopher S.; Sears, J., and Sitkowski, M. Computing deep-tropospheric vertical wind shear analyses for TC applications: Does the methodology matter? Conference on Hurricanes and Tropical Meteorology, 30th, Ponte Vedra Beach, FL, 15-20 April 2012. Boston, MA, American Meteorological Society, 2012.

Wade, Gary S.; Nelson, James P. III; Schmit, Timothy J.; Allegrino, Americo S.; Gutman, Seth I.; Petersen, Ralph A.; Birkenheuer, Daniel L.; Li, Jun; Li, Zhenglong; Holub, Kirk L., and Dworak, Richard. Are sounding profiles from geostationary satellites helping us yet? National Weather Association annual meeting, 37th, Madison, WI, 6-11 October 2012. Raleigh, NC, National Weather Association, 2012.



Walther, Andi. The challenges of generating multi-platform climate data records of cloud parameters from CLAVR-x. 2012 EUMETSAT Meteorological Satellite Conference, Portland, OR, 3-7 September 2012. Proceedings. Darmstadt, Germany, European Organization for the Exploitation of Meteorological Satellites (EUMETSAT), 2012.

Walther, Andi and Heidinger, A. The Daytime Cloud Optical and Microphysical Properties (DCOMP) algorithm. Conference on Satellite Meteorology, Oceanography and Climatology, 18th, and Joint AMS-Asia Satellite Meteorology Conference, 1st, New Orleans, LA, 22-26 January 2012. Boston, MA, American Meteorological Society, 2012.

Wang, Pei; Li, Jun; Schmit, Tim, and Li, Jinlong. Improve tropical cyclone forecasts with hyperspectral infrared sounder data. National Weather Association annual meeting, 37th, Madison, WI, 6-11 October 2012. Raleigh, NC, National Weather Association, 2012.

Wang, Xuanji. Understanding Arctic Sea ice and climate changes from satellite observations. 2012 EUMETSAT Meteorological Satellite Conference, Portland, OR, 3-7 September 2012. Proceedings. Darmstadt, Germany, European Organization for the Exploitation of Meteorological Satellites (EUMETSAT), 2012.

Wanzong, Steve; Bresky, W.; Velden, C. S.; Daniels, J. M., and Rink, T. D. GOES-R AWG Atmospheric Motion Vectors: Validation activities. Conference on Satellite Meteorology, Oceanography and Climatology, 18th, and Joint AMS-Asia Satellite Meteorology Conference, 1st, New Orleans, LA, 22-26 January 2012. Boston, MA, American Meteorological Society, 2012.

Wanzong, Steve; Bresky, Wayne; Velden, Chris; Daniels, Jaime, and Bailey, Andy. GOES-R readiness: Atmospheric Motion Vectors (AMVs) validation activities. International Winds Workshop, 11th, Auckland, New Zealand, 20-24 February 2012. Madison, WI, University of Wisconsin-Madison, Cooperative Institute for Meteorological Satellite Studies (CIMSS), 2012.

Wanzong, Steve; Bresky, Wayne C.; Velden, Christopher S.; Daniels, Jaime M., and Bailey, Andrew A. GOES-R readiness: Atmospheric Motion Vector (AMV) validation activities. International Winds Workshop, 11th, Auckland, New Zealand, 20-24 February 2012. Darmstadt, Germany, EUMETSAT, 2012.

Weygandt, Stephen S.; Lin, H.; Hu, M.; Benjamin, S. G.; Li, J.; Li, T.; Schmit, T. J., and Hofmann, P. Preliminary results from assimilation of AIRS SPOV retrieval profiles in the rapid refresh model system. Annual Symposium on Future Operational Environmental Satellite Systems, 8th, New Orleans, LA, 22-26 January 2012. Boston, MA, American Meteorological Society, 2012.

Whittaker, Thomas M.; Ackerman, S. A., and Jasmin, T. From Java to Flash to HTML5: Chasing technologies for interactive applets. Symposium on Education, 21st, New Orleans, LA, 22-26 January 2012. Boston, MA, American Meteorological Society, 2012.

Whittaker, Tom. Using McIDAS-V for direct processing of GEONETCast/EUMETCast data stream satellite data. 2012 EUMETSAT Meteorological Satellite Conference, Portland, OR, 3-7 September 2012. Proceedings. Darmstadt, Germany, European Organization for the Exploitation of Meteorological Satellites (EUMETSAT), 2012.



Wimmers, Anthony and Feltz, W. F. The GOES-R tropopause folding turbulence product: Finding clear-air turbulence in GOES water vapor imagery. Conference on Satellite Meteorology, Oceanography and Climatology, 18th, and Joint AMS-Asia Satellite Meteorology Conference, 1st, New Orleans, LA, 22-26 January 2012. Boston, MA, American Meteorological Society, 2012.

Wimmers, Anthony and Feltz, Wayne. Methods for detecting turbulence within satellite mountain wave signatures. National Weather Association annual meeting, 37th, Madison, WI, 6-11 October 2012. Raleigh, NC, National Weather Association, 2012.

Wimmers, Anthony; Feltz, Wayne, and Monette, Sarah. The GOES-R Tropopause Folding Turbulence Product: Finding clear-air turbulence in GOES water vapor imagery. National Weather Association annual meeting, 37th, Madison, WI, 6-11 October 2012. Raleigh, NC, National Weather Association, 2012.

Wimmers, Anthony and Heidinger, Andrew. Morphing polar-orbiter imagery of cloud products for improved visualization and forecasting. National Weather Association annual meeting, 37th, Madison, WI, 6-11 October 2012. Raleigh, NC, National Weather Association, 2012.

Wimmers, Anthony and Velden, C. Hurricane center-fixing with the Automated Rotational Center Hurricane Eye Retrieval (ARCHER) method: From microwave to infrared and visible application. Conference on Satellite Meteorology, Oceanography and Climatology, 18th, and Joint AMS-Asia Satellite Meteorology Conference, 1st, New Orleans, LA, 22-26 January 2012. Boston, MA, American Meteorological Society, 2012.

Wimmers, Anthony and Velden, C. S. Advances in objective TC center fixing using multispectral satellite imagery. Conference on Hurricanes and Tropical Meteorology, 30th, Ponte Vedra Beach, FL, 15-20 April 2012. Boston, MA, American Meteorological Society, 2012.

Wimmers, Anthony and Velden, Chris. MIMIC-TPW: Seamless advective blending of total precipitable water retrievals from polar orbiting satellites. National Weather Association annual meeting, 37th, Madison, WI, 6-11 October 2012. Raleigh, NC, National Weather Association, 2012.

Wolf, Walter; Sampson, S.; Garcia, R.; Martin, G. D.; Liu, X.; Yu, T.; Straka, W. III; Qiu, S.; Li, A.; Daniels, J.; Schiffer, E., and Goldberg, M. GOES-R AWG product processing system framework. Annual Symposium on Future Operational Environmental Satellite Systems, 8th, New Orleans, LA, 22-26 January 2012. Boston, MA, American Meteorological Society, 2012.

Wu, Ting-Chi; Liu, H.; Majumdar, S. J.; Velden, C. S., and Anderson, J. Influence of assimilating satellite-derived Atmospheric Motion Vectors (AMVs) on analysis and forecasts of tropical cyclone track and structure. Symposium on Integrated Observing and Assimilation Systems for the Atmosphere, Oceans, and Land Surface (IOAS-AOLS), 16th, New Orleans, LA, 22-26 January 2012. Boston, MA, American Meteorological Society, 2012.

Wu, Ting-Chi; Liu, H.; Majumdar, S. J.; Velden, C. S., and Anderson, J. Influence of assimilating satellite-derived Atmospheric Motion Vectors (AMVs) on analyses and forecast of tropical cyclone track and structure. Conference on Hurricanes and Tropical Meteorology, 30th, Ponte Vedra Beach, FL, 15-20 April 2012. Boston, MA, American Meteorological Society, 2012.



Zhang, Hong; Gunshor, M.; Straka, W.; Martin, G.; Wanzong, S.; Schiffer, E.; Garcia, R., and Huang, A. GRAFIIR - An efficient end-to-end semi automated GOES-R ABI algorithm performance analysis and implementation verification system. Annual Symposium on Future Operational Environmental Satellite Systems, 8th, New Orleans, LA, 22-26 January 2012. Boston, MA, American Meteorological Society, 2012.

Zhang, Yong; Li, Z.; Li, J., and Schmit, T. J. Sea surface emissivity retrieval in Gulf of Mexico using GOES sounder measurements. Conference on Satellite Meteorology, Oceanography and Climatology, 18th, and Joint AMS-Asia Satellite Meteorology Conference, 1st, New Orleans, LA, 22-26 January 2012. Boston, MA, American Meteorological Society, 2012.

Zheng, Jing; Li, J.; Li, J., and Schmit, J. T. Assimilating AIRS soundings with WRF/3DVAR for hurricane forecast improvement. Symposium on Integrated Observing and Assimilation Systems for the Atmosphere, Oceans, and Land Surface (IOAS-AOLS), 16th, New Orleans, LA, 22-26 January 2012. Boston, MA, American Meteorological Society, 2012.

Zhou, Daniel; Larar, Allen; Liu, Xu; Smith, William, and Strow, L. Larrabee. Error Consistency Analysis Scheme (ECAS) for retrieval error budget estimation (Powerpoint presentation). International TOVS Study Conference, 18th, ITSC-18, Toulouse, France, 20-27 March 2012. Madison, WI, University of Wisconsin-Madison, Space Science and Engineering Center, Cooperative Institute for Meteorological Satellite Studies (CIMSS), 2012.